



# THE DATASHEET OF LM3646EVM



# Using the LM3646 Evaluation Module

## User's Guide



Literature Number: SNVU276A  
DECEMBER 2013–Revised July 2014

---



---



---

<b>1</b>	<b>Introduction</b> .....	<b>5</b>
<b>2</b>	<b>Setup</b> .....	<b>5</b>
	2.1 Input/Output Connector Description .....	5
	2.2 Setup.....	7
	2.3 Operation.....	7
<b>3</b>	<b>Board Layout</b> .....	<b>7</b>
<b>4</b>	<b>Schematic</b> .....	<b>11</b>
<b>5</b>	<b>USB Interface Board and I<sup>2</sup>C-Compatible Interface Program</b> .....	<b>14</b>
	5.1 Enable Register (0x01) .....	15
	5.2 Temp and Torch Ramp Register (0x03) .....	16
	5.3 Flash Timing Register (0x04) .....	16
	5.4 LED1 Flash Current Control Register (0x06) .....	16
	5.5 LED1 Torch Current Control Register (0x07) .....	17
	5.6 Max Current Control Register (0x05) .....	17
	<b>Revision History</b> .....	<b>19</b>

## List of Figures

1	Enable Jumper Settings.....	5
2	VIO Jumper Settings .....	5
3	STROBE Jumper Settings.....	6
4	TORCH Jumper Settings .....	6
5	TX Jumper Settings .....	6
6	Top Assembly Layer.....	8
7	Bottom Assembly Layer.....	8
8	Top Layer Routing .....	9
9	Middle Layer 1 Routing .....	9
10	Middle Layer 2 Routing.....	10
11	Bottom Layer Routing.....	10
12	LM3646EVM Schematic.....	11
13	LM3646 General User Interface .....	14
14	I <sup>2</sup> C interface Fields .....	15
15	Immediate Action Fields .....	15
16	Device ID Field .....	15
17	Enable Register.....	15
18	IVFM Mode Register .....	16
19	NTC and Torch Ramp Register .....	16
20	Flash Timing Register .....	16
21	LED1 Flash Current Control Register .....	16
22	LED1 Torch Current Control Register .....	17
23	Max Current Control Register.....	17
24	NTC Log Register .....	17
25	Flags .....	18
26	I/O Pin Controls.....	18

## List of Tables

1	Device and Package Configurations .....	5
---	-----------------------------------------	---

# LM3646EVM User's Guide

## 1 Introduction

The Texas Instrument LM3646EVM evaluation module (EVM) helps designers evaluate the operation and performance of the LM3646 4MHz High-Current LED driver. The device offers configurability via I<sup>2</sup>C-compatible interface. It can be enabled in Flash or Torch mode via the I<sup>2</sup>C interface or externally using the STROBE and TORCH pins. The module utilizes two LEDs (D1 & D2) mounted on the EVM.

The EVM contains one Synchronous Boost LED Flash Driver (See [Table 1](#)).

**Table 1. Device and Package Configurations**

FLASH LED DRIVER	IC	PACKAGE
U1	LM3646	0.4 mm-pitch, 20-Bump DSBGA

## 2 Setup

This section describes the jumpers and connectors on the EVM as well as how to properly connect, set up, and use the LM3646EVM.

### 2.1 Input/Output Connector Description

**Input / GND** - These are the power input terminals for the driver. The terminal block provides a power (VIN) and ground (GND) connection to allow the user to attach the EVM to a cable harness.

**EN (J16)** - This is the jumper used to enable the LED driver. The driver will be enabled when the EN pin is high (VIO) and disabled when it is low (GND).

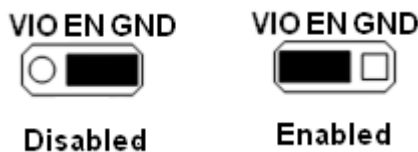

**Figure 1. Enable Jumper Settings**

**VIO (J15)** - This pin provides power for the I<sup>2</sup>C lines (Clock & Data) and for the EN pin. It is recommended that this pin is connected to the VIN pin. If desired, it can be connected to the 3.3V line provided by the USB interface connector. In this configuration, communication via the I<sup>2</sup>C interface may not be possible if the supply voltage to the LED driver is below approximately 3V.

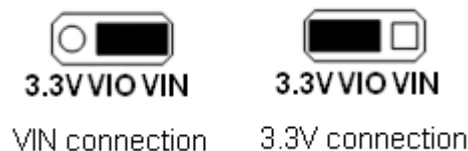

**Figure 2. VIO Jumper Settings**

**D1-CON (J18) and D2-CON (J19)** are the jumpers used to connect the on-board flash LEDs to the LED output of the driver.

**STROBE (J13)** - This pin provides an external method for initiating a flash or torch event. The STROBE pin is connected to ground via a 300-K $\Omega$  resistor internal to the LM3646. To externally drive this pin, either connect a control signal directly to the STROBE pin of the connector or place a jumper between connector pins STROBE and PWM0. Pin PWM0 can be configured as ON, OFF, time-adjustable voltage pulse, or continuous voltage pulses of adjustable frequency and duty cycle via the General User Interface (GUI) software provided.



**Figure 3. STROBE Jumper Settings**

**TORCH (J12)** - This pin provides an external method for initiating a torch event. The TORCH pin is connected to ground via a 300-K $\Omega$  resistor internal to the LM3646. To externally drive this pin, either connect a control signal directly to the TORCH pin of the connector or place a jumper between connector pins TORCH and PWM1. Pin PWM1 can be configured as ON, OFF, time-adjustable voltage pulse, or continuous voltage pulses of adjustable frequency and duty cycle via the GUI software provided.



**Figure 4. TORCH Jumper Settings**

**TX (J14)** - This pin is used to initiate a TX-interrupt event. The TX pin is connected to ground via a 300-K $\Omega$  resistor internal to the LM3646. To externally drive this pin, either connect a control signal directly to the TX pin of the connector or place a jumper between connector pins TX and PWM2. Pin PWM2 can be configured as ON, OFF, time-adjustable voltage pulse or continuous voltage pulses of adjustable frequency and duty cycle via the GUI software provided.



**Figure 5. TX Jumper Settings**

**SDA / SCL (J17)** - These connections allow the user to externally control the I<sup>2</sup>C lines. For independent control of the I<sup>2</sup>C lines, **do not** connect the VIO jumper to either the 3.3V or the VIN pin.

**OUT, LED1, LED2, TEMP (J10, J11, J6)** - These provide access to the regulated output of the driver, the outputs of the LED current sources, and the TEMP pin. The user can measure VOUT with reference to GND, VLED with reference to GND, current source headroom directly between VOUT and VLED, and can monitor or control TEMP input.

**VINL/VIN (J4)** - The user can monitor the Inductor Current and Input Current waveforms by omitting this jumper and using separate wires from the power supply to the VINL and VIN pins. This will remove the Input Capacitors from the Inductor and eliminate their filtering effect to the Inductor Current.

**J7 and J8: LED Current measurements** -The LM3646 EVM provides a way to accurately measure the LED current through both LEDs on board. Resistors R1 & R2 (0.1  $\Omega$ ) are placed between the cathode of LED1 & LED2, respectively, and Ground. The user can first measure the resistor values accurately, by applying a known current through connector DXHF and Ground and measuring the voltage between DXHS and DXLS. Then, during normal flash or torch operation, the voltage measured across the resistor divided by the resistor value will equal the current through the resistor (and the LED).

## 2.2 Setup

The input voltage range for the flash driver is 2.7 volts to 5.5 volts. The on-board LEDs or an LED module should be connected for proper operation.

## 2.3 Operation

For proper operation of the LM3646EVM, the jumpers should be properly configured. The recommended setting, using shorting blocks is:

VIO to VIN

EN to VIO

STROBE to PWM0 or external signal

TORCH to PWM1 or external signal

TX to PWM2 or external signal

LEDs (J18 and J19) shorted

In this configuration, the device will power up when power is applied.

## 3 Board Layout

[Figure 6](#), [Figure 7](#), [Figure 8](#), [Figure 9](#), [Figure 10](#) and [Figure 11](#) show the board layout for the LM3646EVM. The EVM offers resistors, capacitors, and jumpers to enable the device and to configure it as desired.

The LM3646 will dissipate power, especially during high current and long duration flash events. Power will also be dissipated on the flash LEDs. The EVM layout is designed to minimize temperature rise during operation. It is recommended that in order to prevent overheating, repeated flash events in very short time intervals is avoided.



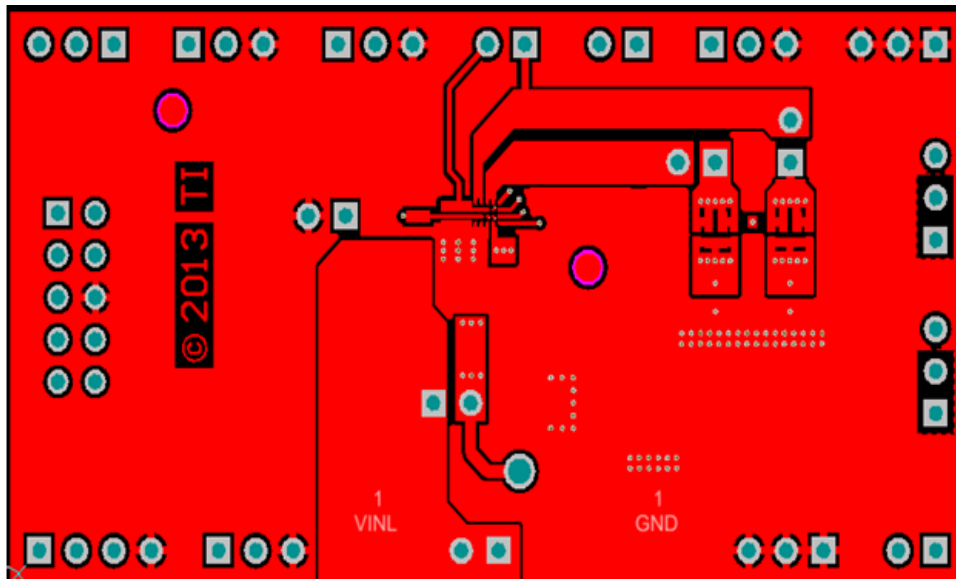

Figure 8. Top Layer Routing

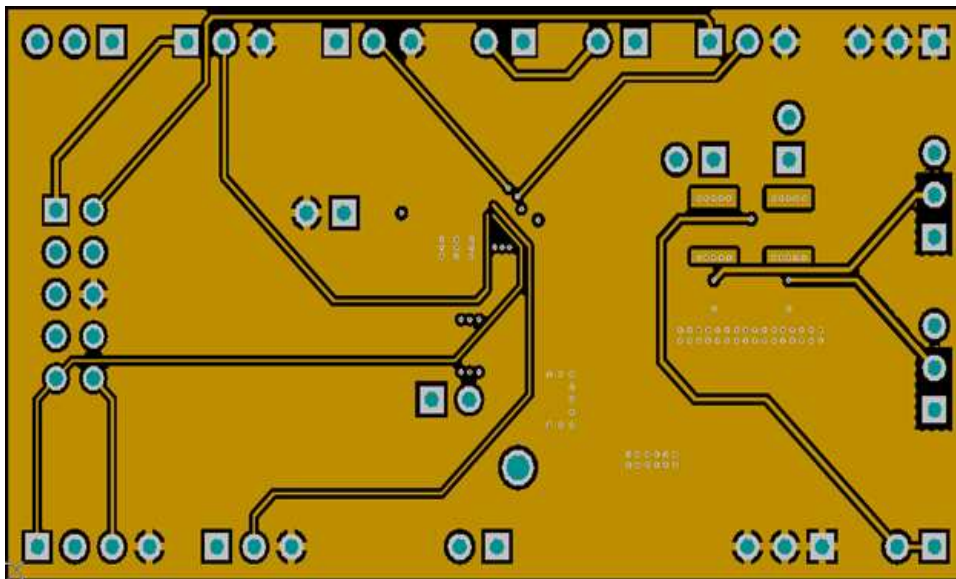

Figure 9. Middle Layer 1 Routing

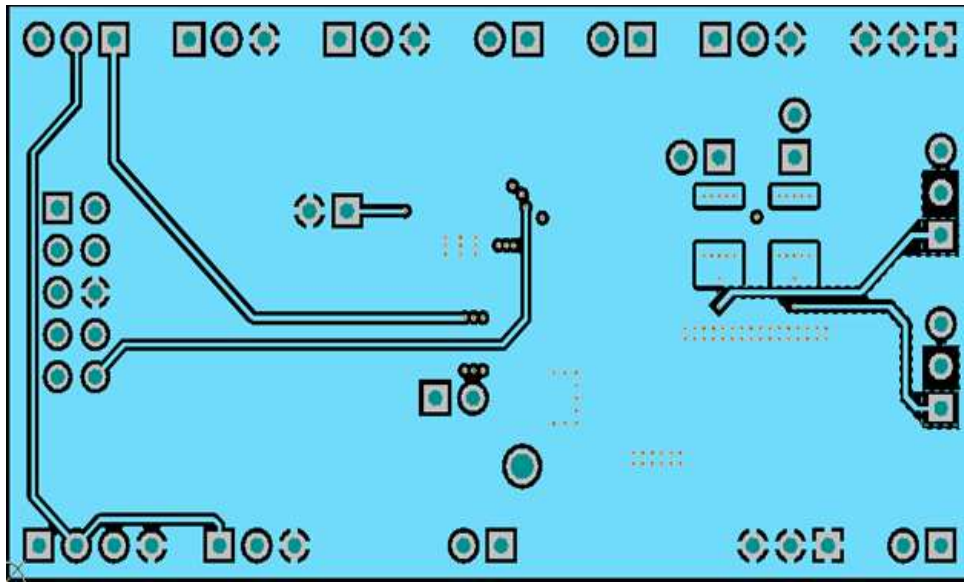

Figure 10. Middle Layer 2 Routing

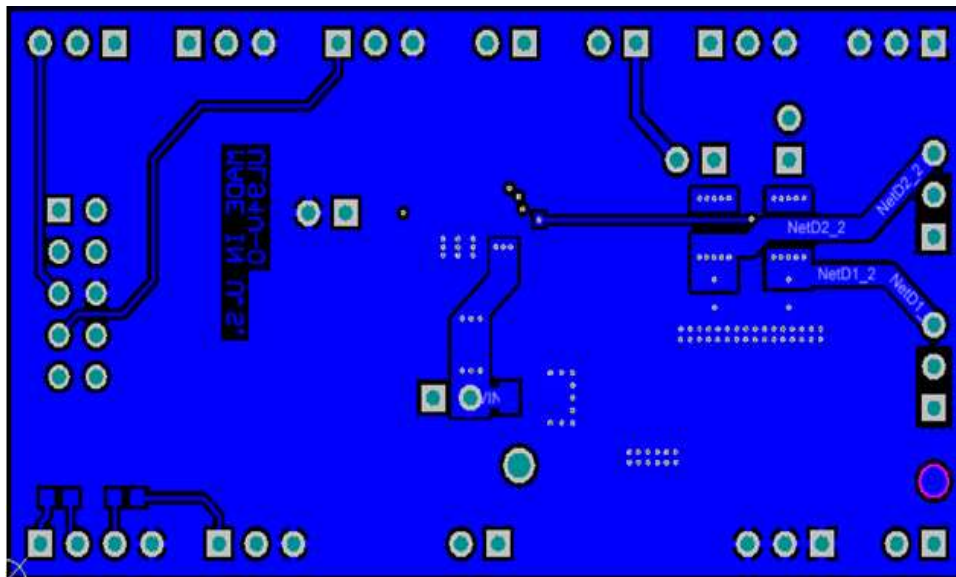
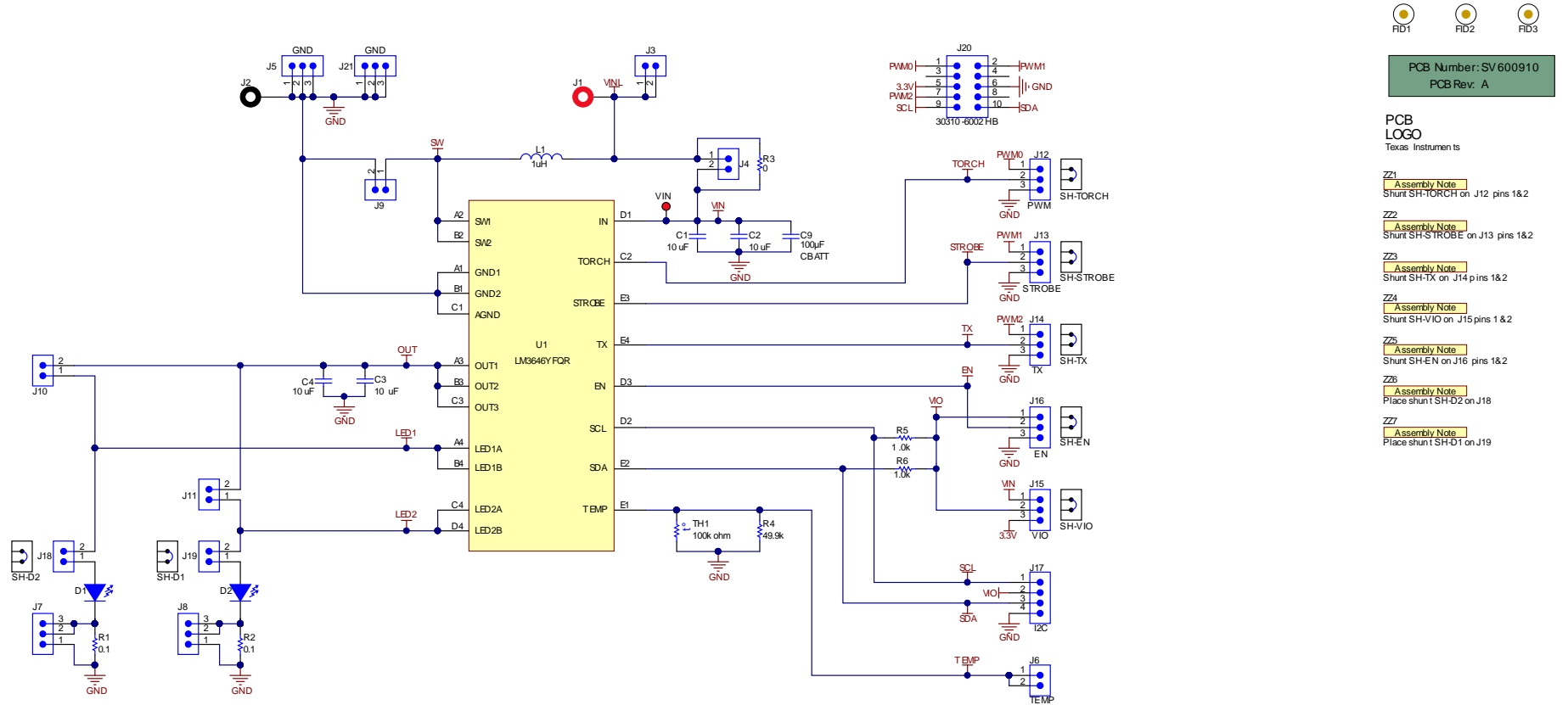

Figure 11. Bottom Layer Routing

4 Schematic



FID1 FID2 FID3

PCB Number: SV 600910  
PCB Rev. A

- PCB LOGO  
Texas Instruments
- ZZ1 Assembly Note  
Shunt SH-TORCH on J12 pins 1&2
  - ZZ2 Assembly Note  
Shunt SH-STROBE on J13 pins 1&2
  - ZZ3 Assembly Note  
Shunt SH-TX on J14 pins 1&2
  - ZZ4 Assembly Note  
Shunt SH-VIO on J15 pins 1&2
  - ZZ5 Assembly Note  
Shunt SH-EN on J16 pins 1&2
  - ZZ6 Assembly Note  
Place shunt SH-D2 on J18
  - ZZ7 Assembly Note  
Place shunt SH-D1 on J19

Figure 12. LM3646EVM Schematic

### Bill of Materials

Item	Designator	Description	Manufacturer	Part Number
1	PCB	Printed Circuit Board	Any	SV600910
2	C1	CAP, CERM, 10 $\mu$ F, 6.3V, X5R 20%, 0402	Murata	GRM155R60J106ME44D
3	C2	CAP, CERM, 10 $\mu$ F, 6.3V, X5R 20%, 0402	Murata	GRM155R60J106ME44D
4	C3	CAP, CERM, 10 $\mu$ F, 6.3V, X5R 20%, 0402	Murata	GRM155R60J106ME44D
5	C4	CAP, CERM, 10 $\mu$ F, 6.3V, X5R 20%, 0402	Murata	GRM155R60J106ME44D
6	C9	CAP, CERM, 100 $\mu$ F, 6.3V, $\pm$ 20%, X5R, 1206	Murata	GRM31CR60J107ME39L
7	D1	LUMILEDS - LXCL-EYW4 - LED, LUXEON, C, COOL WHITE, MIN CRI 75	LUMILEDS	LXCL-EYW4
8	D2	LUMILEDS - LXCL-EYW4 - LED, LUXEON, C, COOL WHITE, MIN CRI 75	LUMILEDS	LXCL-EYW4
9	FID1	Fiducial mark. There is nothing to buy or mount.	N/A	N/A
10	FID2	Fiducial mark. There is nothing to buy or mount.	N/A	N/A
11	FID3	Fiducial mark. There is nothing to buy or mount.	N/A	N/A
12	J1	Standard Banana Jack, Insulated, Red	Keystone	6091
13	J2	Standard Banana Jack, Insulated, Black	Keystone	6092
14	J3	Header, TH, 100mil, 2x1, Gold plated, 230 mil above insulator	Samtec, Inc.	TSW-102-07-G-S
15	J4	Header, TH, 100mil, 2x1, Gold plated, 230 mil above insulator	Samtec, Inc.	TSW-102-07-G-S
16	J5	Header, TH, 100mil, 3x1, Gold plated, 230 mil above insulator	Samtec, Inc.	TSW-103-07-G-S
17	J6	Header, TH, 100mil, 2x1, Gold plated, 230 mil above insulator	Samtec, Inc.	TSW-102-07-G-S
18	J7	Header, TH, 100mil, 3x1, Gold plated, 230 mil above insulator	Samtec, Inc.	TSW-103-07-G-S
19	J8	Header, TH, 100mil, 3x1, Gold plated, 230 mil above insulator	Samtec, Inc.	TSW-103-07-G-S
20	J9	Header, TH, 100mil, 2x1, Gold plated, 230 mil above insulator	Samtec, Inc.	TSW-102-07-G-S
21	J10	Header, TH, 100mil, 2x1, Gold plated, 230 mil above insulator	Samtec, Inc.	TSW-102-07-G-S
22	J11	Header, TH, 100mil, 2x1, Gold plated, 230 mil above insulator	Samtec, Inc.	TSW-102-07-G-S
23	J12	Header, TH, 100mil, 3x1, Gold plated, 230 mil above insulator	Samtec, Inc.	TSW-103-07-G-S
24	J13	Header, TH, 100mil, 3x1, Gold plated, 230 mil above insulator	Samtec, Inc.	TSW-103-07-G-S
25	J14	Header, TH, 100mil, 3x1, Gold plated, 230 mil above insulator	Samtec, Inc.	TSW-103-07-G-S
26	J15	Header, TH, 100mil, 3x1, Gold plated, 230 mil above insulator	Samtec, Inc.	TSW-103-07-G-S
27	J16	Header, TH, 100mil, 3x1, Gold plated, 230 mil above insulator	Samtec, Inc.	TSW-103-07-G-S
28	J17	Header, TH, 100mil, 4x1, Gold plated, 230 mil above insulator	Samtec, Inc.	TSW-104-07-G-S
29	J18	Header, TH, 100mil, 2x1, Gold plated, 230 mil above insulator	Samtec, Inc.	TSW-102-07-G-S
30	J19	Header, TH, 100mil, 2x1, Gold plated, 230 mil above insulator	Samtec, Inc.	TSW-102-07-G-S
31	J20	CONN HEADER 10POS DL STR GOLD	3M	30310-6002HB
32	J21	Header, TH, 100mil, 3x1, Gold plated, 230 mil above insulator	Samtec, Inc.	TSW-103-07-G-S
33	L1	Inductor, Metal Alloy, 1 $\mu$ H, 3.1A, 0.063ohm, SMT	TOKO	1286AS-H-1R0N
34	R1	RES, 0.1 $\Omega$ , 5%, 0.125W, 0805	Panasonic	ERJ-6RSJR10V

**Bill of Materials (continued)**

35	R2	RES, 0.1 $\Omega$ ., 5%, 0.125W, 0805	Panasonic	ERJ-6RSJR10V
36	R3	RES, 0 $\Omega$ ., 5%, 0.25W, 1206	Yageo America	RC1206JR-070RL
37	R4	RES, 49.9 k $\Omega$ ., 1%, 0.063W, 0402	Vishay-Dale	CRCW040249K9FKED
38	R5	RES, 1.0 k $\Omega$ ., 5%, 0.1W, 0603	Vishay-Dale	CRCW06031K00JNEA
39	R6	RES, 1.0 k $\Omega$ ., 5%, 0.1W, 0603	Vishay-Dale	CRCW06031K00JNEA
40	SH-D1	Shunt, 100mil, Gold plated, Black	3M	969102-0000-DA
41	SH-D2	Shunt, 100mil, Gold plated, Black	3M	969102-0000-DA
42	SH-EN	Shunt, 100mil, Gold plated, Black	3M	969102-0000-DA
43	SH-STROBE	Shunt, 100mil, Gold plated, Black	3M	969102-0000-DA
44	SH-TORCH	Shunt, 100mil, Gold plated, Black	3M	969102-0000-DA
45	SH-TX	Shunt, 100mil, Gold plated, Black	3M	969102-0000-DA
46	SH-VIO	Shunt, 100mil, Gold plated, Black	3M	969102-0000-DA
47	TH1	Thermistor NTC, 100 k $\Omega$ , 5%, 0402	MuRata	NCP15WL104J03RC
48	U1	Flash IC LM3646	Texas Instruments	LM3646YFQR
49	VIN	Test Point, TH, Compact, Red	Keystone	5005

## 5 USB Interface Board and I<sup>2</sup>C-Compatible Interface Program

Texas Instruments has created an I<sup>2</sup>C-compatible program and USB docking board that can help exercise the part in a simple way. Contained in this document is a description of how to use the USB docking board and interface software.

The LM3646EVM has the means to “plug into” the USB docking board. The USB docking board provides all the control signals for the simple interface. Power to the part must be provided externally. A USB cable (provided) must be connected to the board from a PC.

The I<sup>2</sup>C-compatible interface program provides all of the control that the LM3646 part requires. For proper operation, the USB docking board should be plugged into the PC before the interface program is opened. Once connected, and the program is executed, a basic interface window will open. The image below shows the default settings.

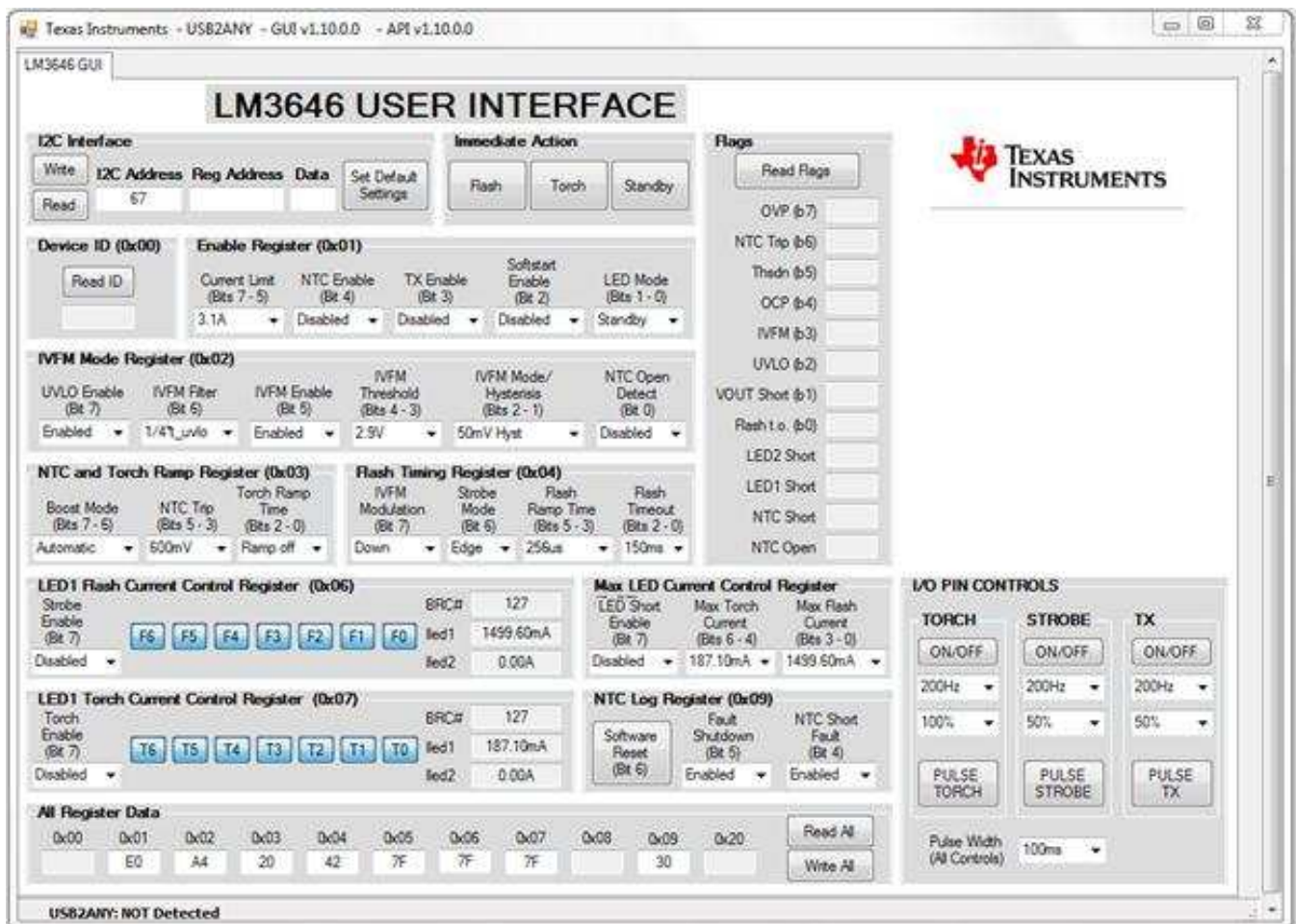

Figure 13. LM3646 General User Interface

The "I<sup>2</sup>C Interface" fields may be used to write or read any LM3646 register. Selecting the "Set Default Settings" button resets all registers to their default values and updates all GUI fields.

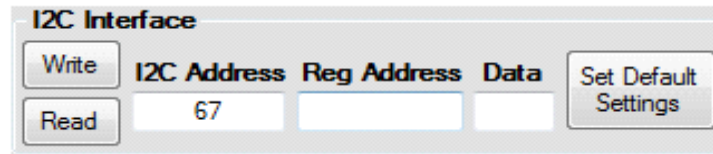

Figure 14. I<sup>2</sup>C interface Fields

Use the "Flash", "Torch", and "Standby" buttons to enable and disable the LED outputs.

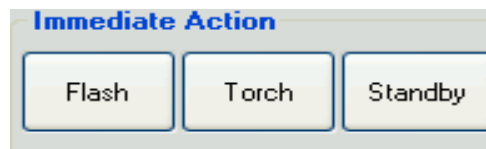

Figure 15. Immediate Action Fields

Use the "Flash", "Torch", and "Standby" buttons to enable and disable the LED outputs.



Figure 16. Device ID Field

### 5.1 Enable Register (0x01)

Use the dropdown menus to select the desired settings. Refer to the LM3646 datasheet's "Register Descriptions" section for details on register settings.

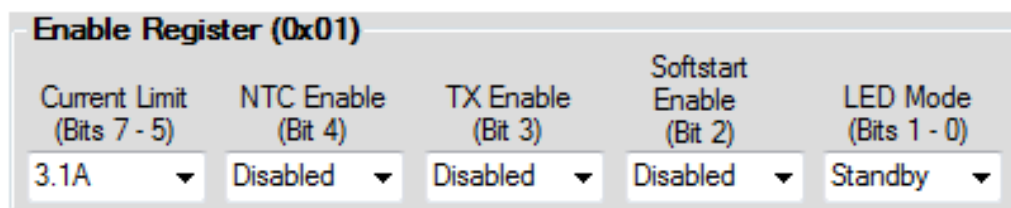

Figure 17. Enable Register

### IVFM Mode Register (0x02)

Use the dropdown menus to select the desirable settings. Refer to the LM3646 datasheet's "Register Descriptions" section for details on register settings.

IVFM Mode Register (0x02)					
UVLO Enable (Bit 7)	IVFM Filter (Bit 6)	IVFM Enable (Bit 5)	IVFM Threshold (Bits 4 - 3)	IVFM Mode/ Hysteresis (Bits 2 - 1)	NTC Open Detect (Bit 0)
Enabled ▾	1/4t <sub>uvlo</sub> ▾	Enabled ▾	2.9V ▾	50mV Hyst ▾	Disabled ▾

Figure 18. IVFM Mode Register

### 5.2 Temp and Torch Ramp Register (0x03)

Use the dropdown menus to select the Torch Ramp Time, NTC trip Threshold, and to control the boost mode of operation.

NTC and Torch Ramp Register (0x03)		
Boost Mode (Bits 7 - 6)	NTC Trip (Bits 5 - 3)	Torch Ramp Time (Bits 2 - 0)
Automatic ▾	600mV ▾	Ramp off ▾

Figure 19. NTC and Torch Ramp Register

### 5.3 Flash Timing Register (0x04)

Use the dropdown menus to select desired Flash Duration, Flash Ramp Time, Edge or Level Strobe mode and IVFM modulation scheme.

Flash Timing Register (0x04)			
IVFM Modulation (Bit 7)	Strobe Mode (Bit 6)	Flash Ramp Time (Bits 5 - 3)	Flash Timeout (Bits 2 - 0)
Down ▾	Edge ▾	256us ▾	150ms ▾

Figure 20. Flash Timing Register

### 5.4 LED1 Flash Current Control Register (0x06)

Use buttons F0 to F6 to select Flash Current level. The fields on the right side of the window get updated upon depression of the FX buttons. Refer to the LM3646 datasheet "Flash Mode" section for explanation of ILED1 / ILED2 flash current settings. Use the "Strobe Enable" dropdown menu to Enable / Disable the external Flash option. If "Enabled" is selected, only STROBE operations are allowed for flash. Use the "Disabled" option to flash using only I<sup>2</sup>C commands.

LED1 Flash Current Control Register (0x06)	
Strobe Enable (Bit 7)	BRC# 127
<input type="button" value="F6"/> <input type="button" value="F5"/> <input type="button" value="F4"/> <input type="button" value="F3"/> <input type="button" value="F2"/> <input type="button" value="F1"/> <input type="button" value="F0"/>	Iled1 1499.60mA
Disabled ▾	Iled2 0.00A

Figure 21. LED1 Flash Current Control Register

### 5.5 LED1 Torch Current Control Register (0x07)

Use buttons F0 to F6 to select Torch Current level. The fields on the right side of the window get updated upon depression of the FX buttons. Refer to the LM3646 datasheet “Torch Mode” section for explanation of ILED1 / ILED2 torch current settings. Use the “Torch Enable” dropdown menu to Enable / Disable the external Torch option. If “Enabled” is selected, only External Torch operations are allowed for torch. Use the “Disabled” option to torch using only I<sup>2</sup>C commands.



Figure 22. LED1 Torch Current Control Register

### 5.6 Max Current Control Register (0x05)

Use the “Max Flash Current” and “Max Torch Current” dropdown menus to select the total flash and torch currents for both LED outputs. Refer to the LM3646 datasheet “Flash Mode” and “Torch Mode” sections for details on ILED1 / ILED2 flash and torch current settings. The “LED Short Enable” dropdown menu can be used to Enable / Disable the LED Short fault.



Figure 23. Max Current Control Register

### NTC Log Register (0x09)

Use the “NTC Short Fault” dropdown menu to Enable / Disable the NTC fault function. Use the “Fault Shutdown” dropdown menu to allow or prevent the LM3646 faults from turning off the device if a fault occurs. Selecting the “Software Reset” buttons resets all registers to their default values and initializes the LM3646.

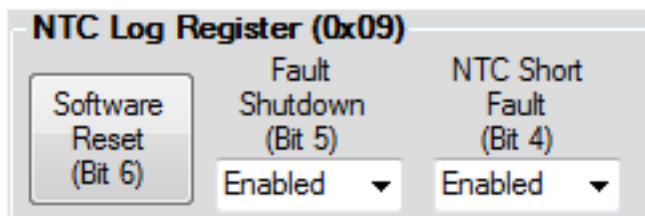

Figure 24. NTC Log Register

### Flags

The contents of the LM3646 fault registers are read upon clicking the “Read Flags” button. The registers are cleared upon read back.

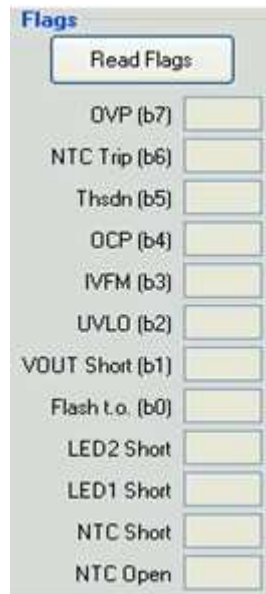

Figure 25. Flags

### I/O Pin Controls

The LM3646 EVM provides the user with the capability to control the TORCH, STROBE and TX inputs without the need of an external supply. The user can choose between continuous pulses at a few frequencies in duty cycle increments of 5%, and a single pulse of various lengths. The “ON/OFF” buttons in the “TORCH”, “STROBE” and “TX” fields control the continuous pulse signals, while the “PULSE” buttons allow for a single pulse signal of the duration selected in the “Pulse Width” drop-down menu.

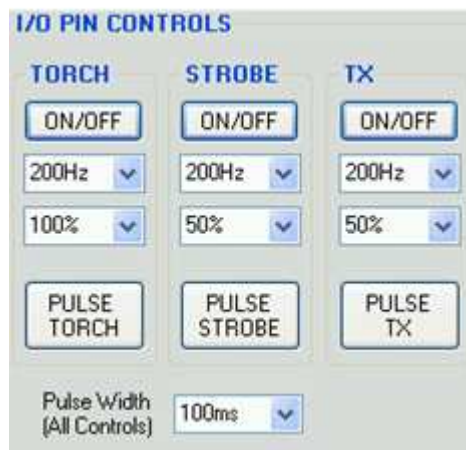

Figure 26. I/O Pin Controls

---

## Revision History

<b>Changes from Original (May 2013) to A Revision</b>	<b>Page</b>
-------------------------------------------------------	-------------

---

- Changed to correct a few typos ..... [5](#)
- 

NOTE: Page numbers for previous revisions may differ from page numbers in the current version.

## STANDARD TERMS AND CONDITIONS FOR EVALUATION MODULES

1. *Delivery:* TI delivers TI evaluation boards, kits, or modules, including any accompanying demonstration software, components, or documentation (collectively, an "EVM" or "EVMs") to the User ("User") in accordance with the terms and conditions set forth herein. Acceptance of the EVM is expressly subject to the following terms and conditions.
  - 1.1 EVMs are intended solely for product or software developers for use in a research and development setting to facilitate feasibility evaluation, experimentation, or scientific analysis of TI semiconductors products. EVMs have no direct function and are not finished products. EVMs shall not be directly or indirectly assembled as a part or subassembly in any finished product. For clarification, any software or software tools provided with the EVM ("Software") shall not be subject to the terms and conditions set forth herein but rather shall be subject to the applicable terms and conditions that accompany such Software
  - 1.2 EVMs are not intended for consumer or household use. EVMs may not be sold, sublicensed, leased, rented, loaned, assigned, or otherwise distributed for commercial purposes by Users, in whole or in part, or used in any finished product or production system.
2. *Limited Warranty and Related Remedies/Disclaimers:*
  - 2.1 These terms and conditions do not apply to Software. The warranty, if any, for Software is covered in the applicable Software License Agreement.
  - 2.2 TI warrants that the TI EVM will conform to TI's published specifications for ninety (90) days after the date TI delivers such EVM to User. Notwithstanding the foregoing, TI shall not be liable for any defects that are caused by neglect, misuse or mistreatment by an entity other than TI, including improper installation or testing, or for any EVMs that have been altered or modified in any way by an entity other than TI. Moreover, TI shall not be liable for any defects that result from User's design, specifications or instructions for such EVMs. Testing and other quality control techniques are used to the extent TI deems necessary or as mandated by government requirements. TI does not test all parameters of each EVM.
  - 2.3 If any EVM fails to conform to the warranty set forth above, TI's sole liability shall be at its option to repair or replace such EVM, or credit User's account for such EVM. TI's liability under this warranty shall be limited to EVMs that are returned during the warranty period to the address designated by TI and that are determined by TI not to conform to such warranty. If TI elects to repair or replace such EVM, TI shall have a reasonable time to repair such EVM or provide replacements. Repaired EVMs shall be warranted for the remainder of the original warranty period. Replaced EVMs shall be warranted for a new full ninety (90) day warranty period.
3. *Regulatory Notices:*
  - 3.1 *United States*
    - 3.1.1 *Notice applicable to EVMs not FCC-Approved:*

This kit is designed to allow product developers to evaluate electronic components, circuitry, or software associated with the kit to determine whether to incorporate such items in a finished product and software developers to write software applications for use with the end product. This kit is not a finished product and when assembled may not be resold or otherwise marketed unless all required FCC equipment authorizations are first obtained. Operation is subject to the condition that this product not cause harmful interference to licensed radio stations and that this product accept harmful interference. Unless the assembled kit is designed to operate under part 15, part 18 or part 95 of this chapter, the operator of the kit must operate under the authority of an FCC license holder or must secure an experimental authorization under part 5 of this chapter.
    - 3.1.2 *For EVMs annotated as FCC – FEDERAL COMMUNICATIONS COMMISSION Part 15 Compliant:*

### CAUTION

This device complies with part 15 of the FCC Rules. Operation is subject to the following two conditions: (1) This device may not cause harmful interference, and (2) this device must accept any interference received, including interference that may cause undesired operation.

Changes or modifications not expressly approved by the party responsible for compliance could void the user's authority to operate the equipment.

### FCC Interference Statement for Class A EVM devices

*NOTE: This equipment has been tested and found to comply with the limits for a Class A digital device, pursuant to part 15 of the FCC Rules. These limits are designed to provide reasonable protection against harmful interference when the equipment is operated in a commercial environment. This equipment generates, uses, and can radiate radio frequency energy and, if not installed and used in accordance with the instruction manual, may cause harmful interference to radio communications. Operation of this equipment in a residential area is likely to cause harmful interference in which case the user will be required to correct the interference at his own expense.*

## FCC Interference Statement for Class B EVM devices

*NOTE: This equipment has been tested and found to comply with the limits for a Class B digital device, pursuant to part 15 of the FCC Rules. These limits are designed to provide reasonable protection against harmful interference in a residential installation. This equipment generates, uses and can radiate radio frequency energy and, if not installed and used in accordance with the instructions, may cause harmful interference to radio communications. However, there is no guarantee that interference will not occur in a particular installation. If this equipment does cause harmful interference to radio or television reception, which can be determined by turning the equipment off and on, the user is encouraged to try to correct the interference by one or more of the following measures:*

- Reorient or relocate the receiving antenna.
- Increase the separation between the equipment and receiver.
- Connect the equipment into an outlet on a circuit different from that to which the receiver is connected.
- Consult the dealer or an experienced radio/TV technician for help.

### 3.2 Canada

#### 3.2.1 For EVMs issued with an Industry Canada Certificate of Conformance to RSS-210

##### **Concerning EVMs Including Radio Transmitters:**

This device complies with Industry Canada license-exempt RSS standard(s). Operation is subject to the following two conditions: (1) this device may not cause interference, and (2) this device must accept any interference, including interference that may cause undesired operation of the device.

##### **Concernant les EVMs avec appareils radio:**

Le présent appareil est conforme aux CNR d'Industrie Canada applicables aux appareils radio exempts de licence. L'exploitation est autorisée aux deux conditions suivantes: (1) l'appareil ne doit pas produire de brouillage, et (2) l'utilisateur de l'appareil doit accepter tout brouillage radioélectrique subi, même si le brouillage est susceptible d'en compromettre le fonctionnement.

##### **Concerning EVMs Including Detachable Antennas:**

Under Industry Canada regulations, this radio transmitter may only operate using an antenna of a type and maximum (or lesser) gain approved for the transmitter by Industry Canada. To reduce potential radio interference to other users, the antenna type and its gain should be so chosen that the equivalent isotropically radiated power (e.i.r.p.) is not more than that necessary for successful communication. This radio transmitter has been approved by Industry Canada to operate with the antenna types listed in the user guide with the maximum permissible gain and required antenna impedance for each antenna type indicated. Antenna types not included in this list, having a gain greater than the maximum gain indicated for that type, are strictly prohibited for use with this device.

##### **Concernant les EVMs avec antennes détachables**

Conformément à la réglementation d'Industrie Canada, le présent émetteur radio peut fonctionner avec une antenne d'un type et d'un gain maximal (ou inférieur) approuvé pour l'émetteur par Industrie Canada. Dans le but de réduire les risques de brouillage radioélectrique à l'intention des autres utilisateurs, il faut choisir le type d'antenne et son gain de sorte que la puissance isotrope rayonnée équivalente (p.i.r.e.) ne dépasse pas l'intensité nécessaire à l'établissement d'une communication satisfaisante. Le présent émetteur radio a été approuvé par Industrie Canada pour fonctionner avec les types d'antenne énumérés dans le manuel d'usage et ayant un gain admissible maximal et l'impédance requise pour chaque type d'antenne. Les types d'antenne non inclus dans cette liste, ou dont le gain est supérieur au gain maximal indiqué, sont strictement interdits pour l'exploitation de l'émetteur.

### 3.3 Japan

3.3.1 *Notice for EVMs delivered in Japan:* Please see [http://www.tij.co.jp/lstds/ti\\_ja/general/eStore/notice\\_01.page](http://www.tij.co.jp/lstds/ti_ja/general/eStore/notice_01.page) 日本国内に輸入される評価用キット、ボードについては、次のところをご覧ください。  
[http://www.tij.co.jp/lstds/ti\\_ja/general/eStore/notice\\_01.page](http://www.tij.co.jp/lstds/ti_ja/general/eStore/notice_01.page)

3.3.2 *Notice for Users of EVMs Considered "Radio Frequency Products" in Japan:* EVMs entering Japan may not be certified by TI as conforming to Technical Regulations of Radio Law of Japan.

If User uses EVMs in Japan, not certified to Technical Regulations of Radio Law of Japan, User is required by Radio Law of Japan to follow the instructions below with respect to EVMs:

1. Use EVMs in a shielded room or any other test facility as defined in the notification #173 issued by Ministry of Internal Affairs and Communications on March 28, 2006, based on Sub-section 1.1 of Article 6 of the Ministry's Rule for Enforcement of Radio Law of Japan,
2. Use EVMs only after User obtains the license of Test Radio Station as provided in Radio Law of Japan with respect to EVMs, or
3. Use of EVMs only after User obtains the Technical Regulations Conformity Certification as provided in Radio Law of Japan with respect to EVMs. Also, do not transfer EVMs, unless User gives the same notice above to the transferee. Please note that if User does not follow the instructions above, User will be subject to penalties of Radio Law of Japan.

【無線電波を送信する製品の開発キットをお使いになる際の注意事項】 開発キットの中には技術基準適合証明を受けていないものがあります。技術適合証明を受けていないものご使用に際しては、電波法遵守のため、以下のいずれかの措置を取っていただく必要がありますのでご注意ください。

1. 電波法施行規則第6条第1項第1号に基づく平成18年3月28日総務省告示第173号で定められた電波暗室等の試験設備でご使用いただく。
2. 実験局の免許を取得後ご使用いただく。
3. 技術基準適合証明を取得後ご使用いただく。

なお、本製品は、上記の「ご使用にあたっての注意」を譲渡先、移転先に通知しない限り、譲渡、移転できないものとします。

上記を遵守頂けない場合は、電波法の罰則が適用される可能性があることをご留意ください。日本テキサス・インスツルメンツ株式会社

東京都新宿区西新宿 6 丁目 2 4 番 1 号

西新宿三井ビル

3.3.3 *Notice for EVMs for Power Line Communication:* Please see [http://www.tij.co.jp/llds/ti\\_ja/general/eStore/notice\\_02.page](http://www.tij.co.jp/llds/ti_ja/general/eStore/notice_02.page)

電力線搬送波通信についての開発キットをお使いになる際の注意事項については、次のところをご覧ください。[http://www.tij.co.jp/llds/ti\\_ja/general/eStore/notice\\_02.page](http://www.tij.co.jp/llds/ti_ja/general/eStore/notice_02.page)

#### 4 *EVM Use Restrictions and Warnings:*

4.1 EVMS ARE NOT FOR USE IN FUNCTIONAL SAFETY AND/OR SAFETY CRITICAL EVALUATIONS, INCLUDING BUT NOT LIMITED TO EVALUATIONS OF LIFE SUPPORT APPLICATIONS.

4.2 User must read and apply the user guide and other available documentation provided by TI regarding the EVM prior to handling or using the EVM, including without limitation any warning or restriction notices. The notices contain important safety information related to, for example, temperatures and voltages.

#### 4.3 *Safety-Related Warnings and Restrictions:*

4.3.1 User shall operate the EVM within TI's recommended specifications and environmental considerations stated in the user guide, other available documentation provided by TI, and any other applicable requirements and employ reasonable and customary safeguards. Exceeding the specified performance ratings and specifications (including but not limited to input and output voltage, current, power, and environmental ranges) for the EVM may cause personal injury or death, or property damage. If there are questions concerning performance ratings and specifications, User should contact a TI field representative prior to connecting interface electronics including input power and intended loads. Any loads applied outside of the specified output range may also result in unintended and/or inaccurate operation and/or possible permanent damage to the EVM and/or interface electronics. Please consult the EVM user guide prior to connecting any load to the EVM output. If there is uncertainty as to the load specification, please contact a TI field representative. During normal operation, even with the inputs and outputs kept within the specified allowable ranges, some circuit components may have elevated case temperatures. These components include but are not limited to linear regulators, switching transistors, pass transistors, current sense resistors, and heat sinks, which can be identified using the information in the associated documentation. When working with the EVM, please be aware that the EVM may become very warm.

4.3.2 EVMs are intended solely for use by technically qualified, professional electronics experts who are familiar with the dangers and application risks associated with handling electrical mechanical components, systems, and subsystems. User assumes all responsibility and liability for proper and safe handling and use of the EVM by User or its employees, affiliates, contractors or designees. User assumes all responsibility and liability to ensure that any interfaces (electronic and/or mechanical) between the EVM and any human body are designed with suitable isolation and means to safely limit accessible leakage currents to minimize the risk of electrical shock hazard. User assumes all responsibility and liability for any improper or unsafe handling or use of the EVM by User or its employees, affiliates, contractors or designees.

4.4 User assumes all responsibility and liability to determine whether the EVM is subject to any applicable international, federal, state, or local laws and regulations related to User's handling and use of the EVM and, if applicable, User assumes all responsibility and liability for compliance in all respects with such laws and regulations. User assumes all responsibility and liability for proper disposal and recycling of the EVM consistent with all applicable international, federal, state, and local requirements.

5. *Accuracy of Information:* To the extent TI provides information on the availability and function of EVMs, TI attempts to be as accurate as possible. However, TI does not warrant the accuracy of EVM descriptions, EVM availability or other information on its websites as accurate, complete, reliable, current, or error-free.

6. *Disclaimers:*
- 6.1 EXCEPT AS SET FORTH ABOVE, EVMS AND ANY WRITTEN DESIGN MATERIALS PROVIDED WITH THE EVM (AND THE DESIGN OF THE EVM ITSELF) ARE PROVIDED "AS IS" AND "WITH ALL FAULTS." TI DISCLAIMS ALL OTHER WARRANTIES, EXPRESS OR IMPLIED, REGARDING SUCH ITEMS, INCLUDING BUT NOT LIMITED TO ANY IMPLIED WARRANTIES OF MERCHANTABILITY OR FITNESS FOR A PARTICULAR PURPOSE OR NON-INFRINGEMENT OF ANY THIRD PARTY PATENTS, COPYRIGHTS, TRADE SECRETS OR OTHER INTELLECTUAL PROPERTY RIGHTS.
- 6.2 EXCEPT FOR THE LIMITED RIGHT TO USE THE EVM SET FORTH HEREIN, NOTHING IN THESE TERMS AND CONDITIONS SHALL BE CONSTRUED AS GRANTING OR CONFERRING ANY RIGHTS BY LICENSE, PATENT, OR ANY OTHER INDUSTRIAL OR INTELLECTUAL PROPERTY RIGHT OF TI, ITS SUPPLIERS/LICENSORS OR ANY OTHER THIRD PARTY, TO USE THE EVM IN ANY FINISHED END-USER OR READY-TO-USE FINAL PRODUCT, OR FOR ANY INVENTION, DISCOVERY OR IMPROVEMENT MADE, CONCEIVED OR ACQUIRED PRIOR TO OR AFTER DELIVERY OF THE EVM.
7. *USER'S INDEMNITY OBLIGATIONS AND REPRESENTATIONS.* USER WILL DEFEND, INDEMNIFY AND HOLD TI, ITS LICENSORS AND THEIR REPRESENTATIVES HARMLESS FROM AND AGAINST ANY AND ALL CLAIMS, DAMAGES, LOSSES, EXPENSES, COSTS AND LIABILITIES (COLLECTIVELY, "CLAIMS") ARISING OUT OF OR IN CONNECTION WITH ANY HANDLING OR USE OF THE EVM THAT IS NOT IN ACCORDANCE WITH THESE TERMS AND CONDITIONS. THIS OBLIGATION SHALL APPLY WHETHER CLAIMS ARISE UNDER STATUTE, REGULATION, OR THE LAW OF TORT, CONTRACT OR ANY OTHER LEGAL THEORY, AND EVEN IF THE EVM FAILS TO PERFORM AS DESCRIBED OR EXPECTED.
8. *Limitations on Damages and Liability:*
- 8.1 *General Limitations.* IN NO EVENT SHALL TI BE LIABLE FOR ANY SPECIAL, COLLATERAL, INDIRECT, PUNITIVE, INCIDENTAL, CONSEQUENTIAL, OR EXEMPLARY DAMAGES IN CONNECTION WITH OR ARISING OUT OF THESE TERMS AND CONDITIONS OR THE USE OF THE EVMS PROVIDED HEREUNDER, REGARDLESS OF WHETHER TI HAS BEEN ADVISED OF THE POSSIBILITY OF SUCH DAMAGES. EXCLUDED DAMAGES INCLUDE, BUT ARE NOT LIMITED TO, COST OF REMOVAL OR REINSTALLATION, ANCILLARY COSTS TO THE PROCUREMENT OF SUBSTITUTE GOODS OR SERVICES, RETESTING, OUTSIDE COMPUTER TIME, LABOR COSTS, LOSS OF GOODWILL, LOSS OF PROFITS, LOSS OF SAVINGS, LOSS OF USE, LOSS OF DATA, OR BUSINESS INTERRUPTION. NO CLAIM, SUIT OR ACTION SHALL BE BROUGHT AGAINST TI MORE THAN ONE YEAR AFTER THE RELATED CAUSE OF ACTION HAS OCCURRED.
- 8.2 *Specific Limitations.* IN NO EVENT SHALL TI'S AGGREGATE LIABILITY FROM ANY WARRANTY OR OTHER OBLIGATION ARISING OUT OF OR IN CONNECTION WITH THESE TERMS AND CONDITIONS, OR ANY USE OF ANY TI EVM PROVIDED HEREUNDER, EXCEED THE TOTAL AMOUNT PAID TO TI FOR THE PARTICULAR UNITS SOLD UNDER THESE TERMS AND CONDITIONS WITH RESPECT TO WHICH LOSSES OR DAMAGES ARE CLAIMED. THE EXISTENCE OF MORE THAN ONE CLAIM AGAINST THE PARTICULAR UNITS SOLD TO USER UNDER THESE TERMS AND CONDITIONS SHALL NOT ENLARGE OR EXTEND THIS LIMIT.
9. *Return Policy.* Except as otherwise provided, TI does not offer any refunds, returns, or exchanges. Furthermore, no return of EVM(s) will be accepted if the package has been opened and no return of the EVM(s) will be accepted if they are damaged or otherwise not in a resalable condition. If User feels it has been incorrectly charged for the EVM(s) it ordered or that delivery violates the applicable order, User should contact TI. All refunds will be made in full within thirty (30) working days from the return of the components(s), excluding any postage or packaging costs.
10. *Governing Law:* These terms and conditions shall be governed by and interpreted in accordance with the laws of the State of Texas, without reference to conflict-of-laws principles. User agrees that non-exclusive jurisdiction for any dispute arising out of or relating to these terms and conditions lies within courts located in the State of Texas and consents to venue in Dallas County, Texas. Notwithstanding the foregoing, any judgment may be enforced in any United States or foreign court, and TI may seek injunctive relief in any United States or foreign court.

Mailing Address: Texas Instruments, Post Office Box 655303, Dallas, Texas 75265  
Copyright © 2015, Texas Instruments Incorporated

## IMPORTANT NOTICE

Texas Instruments Incorporated and its subsidiaries (TI) reserve the right to make corrections, enhancements, improvements and other changes to its semiconductor products and services per JESD46, latest issue, and to discontinue any product or service per JESD48, latest issue. Buyers should obtain the latest relevant information before placing orders and should verify that such information is current and complete. All semiconductor products (also referred to herein as "components") are sold subject to TI's terms and conditions of sale supplied at the time of order acknowledgment.

TI warrants performance of its components to the specifications applicable at the time of sale, in accordance with the warranty in TI's terms and conditions of sale of semiconductor products. Testing and other quality control techniques are used to the extent TI deems necessary to support this warranty. Except where mandated by applicable law, testing of all parameters of each component is not necessarily performed.

TI assumes no liability for applications assistance or the design of Buyers' products. Buyers are responsible for their products and applications using TI components. To minimize the risks associated with Buyers' products and applications, Buyers should provide adequate design and operating safeguards.

TI does not warrant or represent that any license, either express or implied, is granted under any patent right, copyright, mask work right, or other intellectual property right relating to any combination, machine, or process in which TI components or services are used. Information published by TI regarding third-party products or services does not constitute a license to use such products or services or a warranty or endorsement thereof. Use of such information may require a license from a third party under the patents or other intellectual property of the third party, or a license from TI under the patents or other intellectual property of TI.

Reproduction of significant portions of TI information in TI data books or data sheets is permissible only if reproduction is without alteration and is accompanied by all associated warranties, conditions, limitations, and notices. TI is not responsible or liable for such altered documentation. Information of third parties may be subject to additional restrictions.

Resale of TI components or services with statements different from or beyond the parameters stated by TI for that component or service voids all express and any implied warranties for the associated TI component or service and is an unfair and deceptive business practice. TI is not responsible or liable for any such statements.

Buyer acknowledges and agrees that it is solely responsible for compliance with all legal, regulatory and safety-related requirements concerning its products, and any use of TI components in its applications, notwithstanding any applications-related information or support that may be provided by TI. Buyer represents and agrees that it has all the necessary expertise to create and implement safeguards which anticipate dangerous consequences of failures, monitor failures and their consequences, lessen the likelihood of failures that might cause harm and take appropriate remedial actions. Buyer will fully indemnify TI and its representatives against any damages arising out of the use of any TI components in safety-critical applications.

In some cases, TI components may be promoted specifically to facilitate safety-related applications. With such components, TI's goal is to help enable customers to design and create their own end-product solutions that meet applicable functional safety standards and requirements. Nonetheless, such components are subject to these terms.

No TI components are authorized for use in FDA Class III (or similar life-critical medical equipment) unless authorized officers of the parties have executed a special agreement specifically governing such use.

Only those TI components which TI has specifically designated as military grade or "enhanced plastic" are designed and intended for use in military/aerospace applications or environments. Buyer acknowledges and agrees that any military or aerospace use of TI components which have **not** been so designated is solely at the Buyer's risk, and that Buyer is solely responsible for compliance with all legal and regulatory requirements in connection with such use.

TI has specifically designated certain components as meeting ISO/TS16949 requirements, mainly for automotive use. In any case of use of non-designated products, TI will not be responsible for any failure to meet ISO/TS16949.

### Products

Audio	<a href="http://www.ti.com/audio">www.ti.com/audio</a>
Amplifiers	<a href="http://amplifier.ti.com">amplifier.ti.com</a>
Data Converters	<a href="http://dataconverter.ti.com">dataconverter.ti.com</a>
DLP® Products	<a href="http://www.dlp.com">www.dlp.com</a>
DSP	<a href="http://dsp.ti.com">dsp.ti.com</a>
Clocks and Timers	<a href="http://www.ti.com/clocks">www.ti.com/clocks</a>
Interface	<a href="http://interface.ti.com">interface.ti.com</a>
Logic	<a href="http://logic.ti.com">logic.ti.com</a>
Power Mgmt	<a href="http://power.ti.com">power.ti.com</a>
Microcontrollers	<a href="http://microcontroller.ti.com">microcontroller.ti.com</a>
RFID	<a href="http://www.ti-rfid.com">www.ti-rfid.com</a>
OMAP Applications Processors	<a href="http://www.ti.com/omap">www.ti.com/omap</a>
Wireless Connectivity	<a href="http://www.ti.com/wirelessconnectivity">www.ti.com/wirelessconnectivity</a>

### Applications

Automotive and Transportation	<a href="http://www.ti.com/automotive">www.ti.com/automotive</a>
Communications and Telecom	<a href="http://www.ti.com/communications">www.ti.com/communications</a>
Computers and Peripherals	<a href="http://www.ti.com/computers">www.ti.com/computers</a>
Consumer Electronics	<a href="http://www.ti.com/consumer-apps">www.ti.com/consumer-apps</a>
Energy and Lighting	<a href="http://www.ti.com/energy">www.ti.com/energy</a>
Industrial	<a href="http://www.ti.com/industrial">www.ti.com/industrial</a>
Medical	<a href="http://www.ti.com/medical">www.ti.com/medical</a>
Security	<a href="http://www.ti.com/security">www.ti.com/security</a>
Space, Avionics and Defense	<a href="http://www.ti.com/space-avionics-defense">www.ti.com/space-avionics-defense</a>
Video and Imaging	<a href="http://www.ti.com/video">www.ti.com/video</a>

### TI E2E Community

[e2e.ti.com](http://e2e.ti.com)

## Looking for pricing, stock, or lifecycle information?

Click below to explore more details on WIN SOURCE:

 [View LM3646EVM](#) on WIN SOURCE

 [Texas Instruments](#) Information

## Optimize Your Supply Chain with WIN SOURCE Solutions

-  Global Sourcing Solution
-  Obsolete Management
-  Cost Control Management
-  Shortage Management
-  Alternative Solution
-  Excess Inventory Management