



**THE DATASHEET OF
DAN212KT146**



Ultra high-speed switching diode arrays

DA114 / DA121 / DA227

DAN202K / DAN202U / DAN212K / DAN222

DAP202K / DAP202U / DAP222

●Applications

Ultra high speed switching





●Features

- 1) Four types of packaging are available.
- 2) High reliability.
- 3) High speed. (Typical recovery time= 1.5ns)
- 4) Suitable for high packing density layout.

●Construction

Silicon epitaxial planar

●Marking

DAN222 DAN202U DAN202K	
DAP222 DAP202U DAP202K	
DA121 DA114 DAN212K	
DA227	

●External dimensions (Units : mm)

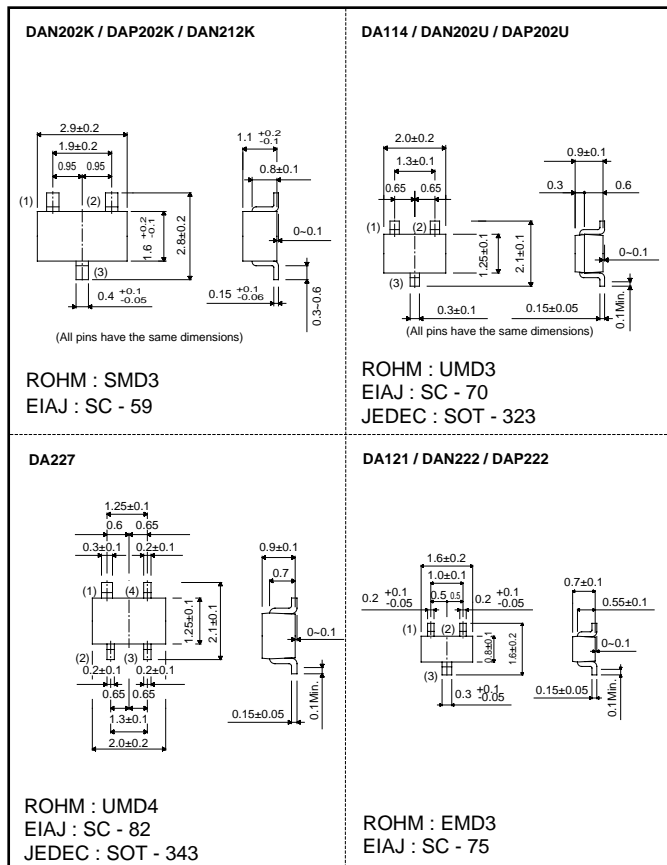

●Equivalent circuits

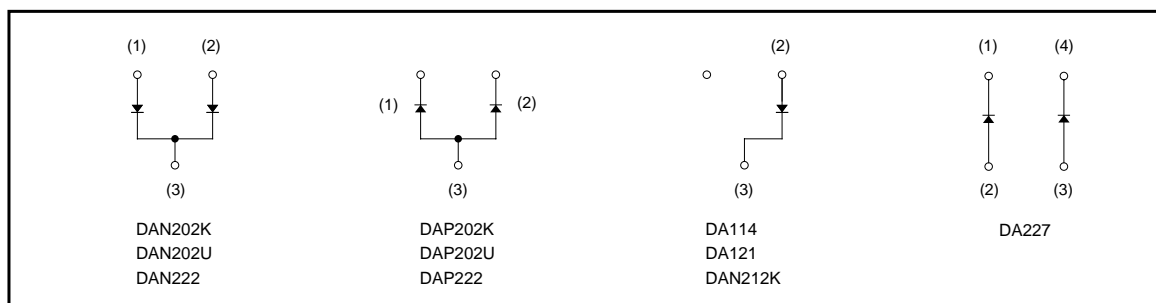

●Absolute maximum ratings (Ta=25°C)

Type	Peak reverse voltage V _{RM} (V)	DC reverse voltage V _R (V)	Peak forward current I _{FM} (mA)	Mean rectifying current I _o (mA)	Surge current (1μs) I _{surge} (A)	Power dissipation (TOTAL) Pd(mW)	Junction temperature T _j (°C)	Storage temperature T _{stg} (°C)	TYPE
DA114	80	80	300	100	4	200	150	-55~+150	N
DA121	80	80	300	100	4	150	150	-55~+150	N
DAN202K	80	80	300	100	4	200	150	-55~+150	N
DAP202K	80	80	300	100	4	200	150	-55~+150	P
DAN202U	80	80	300	100	4	150	150	-55~+150	N
DAP202U	80	80	300	100	4	150	150	-55~+150	P
DAN212K	80	80	300	100	4	200	150	-55~+150	N
DAN222	80	80	300	100	4	150	150	-55~+150	N
DAP222	80	80	300	100	4	150	150	-55~+150	P
DA227	80	80	300	100	4	150	150	-55~+150	N

●Electrical characteristics (Ta=25°C)

Type	Forward voltage		Reverse current		Capacitance between terminals			Reverse recovery time		
	V _F (V) Max.	Cond.	I _R (μA) Max.	Cond.	C _T (pF) Max.	Cond.		t _{rr} (ns) Max.	Cond.	
		I _F (mA)		V _R (V)		V _R (V)	f (MHz)		V _R (V)	I _F (mA)
DA114	1.2	100	0.1	70	3.5	6	1	4	6	5
DA121	1.2	100	0.1	70	3.5	6	1	4	6	5
DAN202K	1.2	100	0.1	70	3.5	6	1	4	6	5
DAP202K	1.2	100	0.1	70	3.5	6	1	4	6	5
DAN202U	1.2	100	0.1	70	3.5	6	1	4	6	5
DAP202U	1.2	100	0.1	70	3.5	6	1	4	6	5
DAN212K	1.2	100	0.1	70	3.5	6	1	4	6	5
DAN222	1.2	100	0.1	70	3.5	6	1	4	6	5
DAP222	1.2	100	0.1	70	3.5	6	1	4	6	5
DA227	1.2	100	0.1	70	3.5	6	1	4	6	5

●Electrical characteristic curves (Ta=25°C unless specified otherwise)

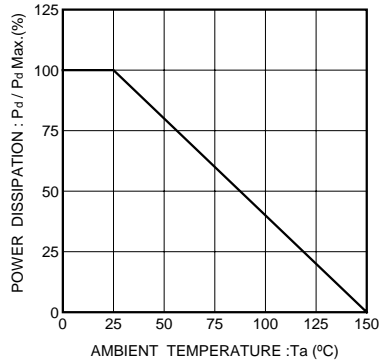

Fig. 1 Derating curve (mounting on glass epoxy PCBs)

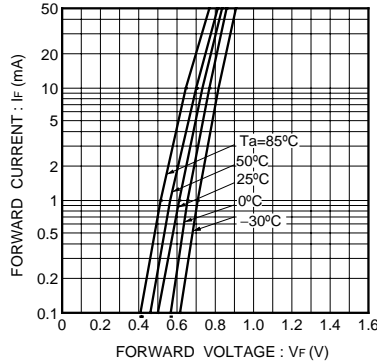

Fig. 2 Forward current vs. forward voltage (P TYPE)

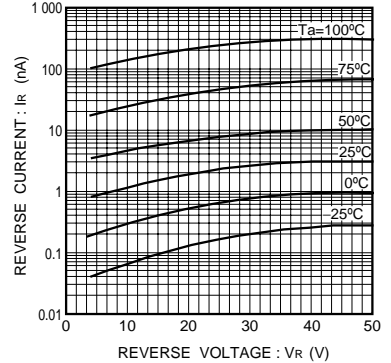

Fig. 3 Reverse current vs. reverse voltage (P TYPE)

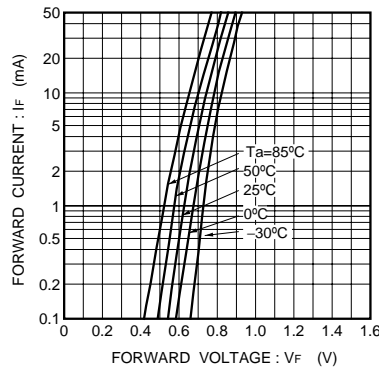

Fig. 4 Forward current vs. forward voltage (N TYPE)

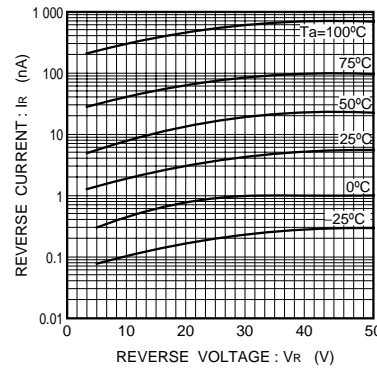

Fig. 5 Reverse current vs. reverse voltage (N TYPE)

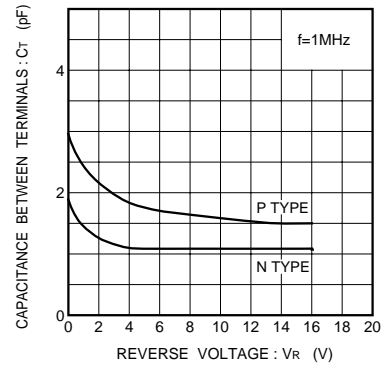

Fig. 6 Capacitance between terminals vs. reverse voltage

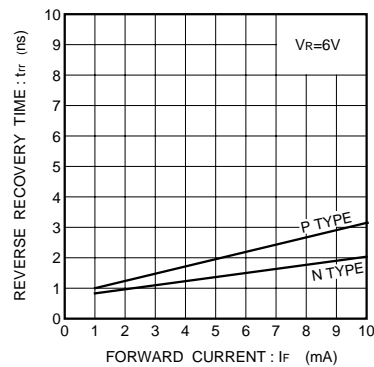

Fig. 7 Reverse recovery time vs. forward current

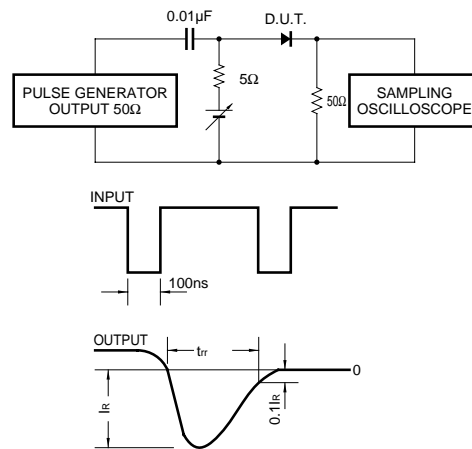



Fig. 8 Reverse recovery time (tr) measurement circuit

Looking for pricing, stock, or lifecycle information?

Click below to explore more details on WIN SOURCE:

-  [View DAN212KT146 on WIN SOURCE](#)
-  [Rohm Semiconductor](#) Information

Optimize Your Supply Chain with WIN SOURCE Solutions

-  Global Sourcing Solution
-  Obsolete Management
-  Cost Control Management
-  Shortage Management
-  Alternative Solution
-  Excess Inventory Management