



**THE DATASHEET OF  
MAX98304EWL+T**



# MAX98304

## Mono 3.2W Class D Amplifier

### General Description

The MAX98304 mono 3.2W Class D amplifier provides Class AB audio performance with Class D efficiency. This device offers five selectable gain settings (0dB, 3dB, 6dB, 9dB, and 12dB) set by a single gain-select input (GAIN).

Active emissions-limiting, edge-rate, and overshoot control circuitry greatly reduces EMI. A filterless spread-spectrum modulation scheme eliminates the need for output filtering found in traditional Class D devices. These features reduce application component count.

The IC's 0.95mA at 3.7V (1.2mA at 5V) quiescent current extends battery life in portable applications.

The IC is available in a 9-bump (1.0mm x 1.0mm) WLP with 0.3mm pitch that is specified over the extended -40°C to +85°C temperature range.

### Applications

Notebook and Netbook Computers  
 Cellular Phones  
 Tablets  
 MP3 Players  
 Portable Audio Players  
 VoIP Phones

### Typical Application Circuit

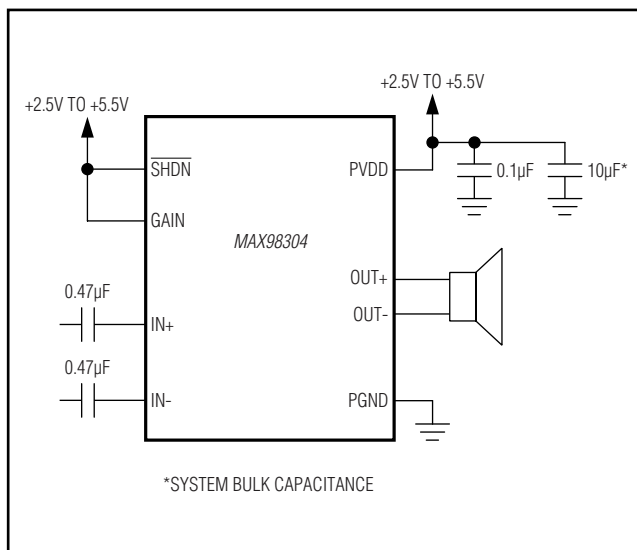

### Features

- ◆ **Low Quiescent Current: 0.95mA at 3.7V**
- ◆ **Spread Spectrum and Active Emissions Limiting**
- ◆ **Five Pin-Selectable Gains**
- ◆ **19µVRMS Ultra-Low Noise**
- ◆ **90dB PSRR**
- ◆ **Click-and-Pop Suppression**
- ◆ **Thermal and Overcurrent Protection**
- ◆ **Low-Current Shutdown Mode**
- ◆ **1.0mm x 1.0mm, 9-Bump WLP (0.3mm Pitch) Space-Saving Package**

### Ordering Information

PART	TEMP RANGE	PIN-PACKAGE	TOP MARK
MAX98304EWL+	-40°C to +85°C	9 WLP	AIR

+Denotes a lead(Pb)-free/RoHS-compliant package.

Visit [www.maximintegrated.com/products/patents](http://www.maximintegrated.com/products/patents) for product patent marking information.

### Bump Configuration

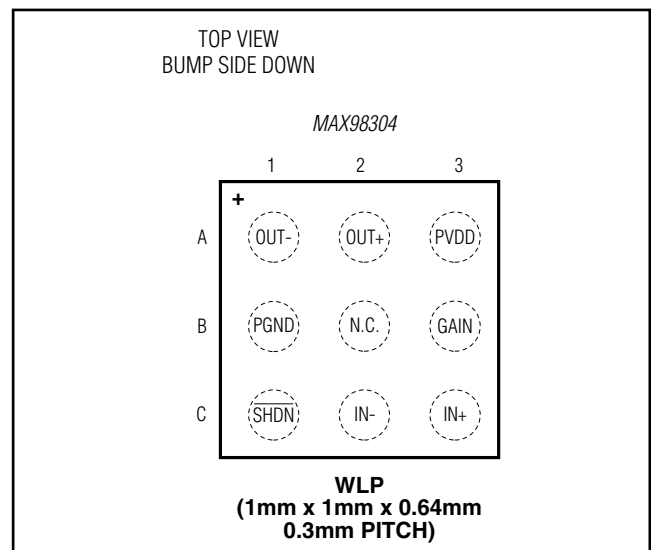

# MAX98304

## Mono 3.2W Class D Amplifier

### ABSOLUTE MAXIMUM RATINGS

PVDD, IN+, IN-,  $\overline{\text{SHDN}}$ , GAIN to PGND.....-0.3V to +6V  
 All Other Pins to PGND .....-0.3V to (VPVDD + 0.3V)  
 Continuous Current Into/Out of PVDD, PGND, OUT\_...  $\pm 750\text{mA}$   
 Continuous Input Current (all other pins).....  $\pm 20\text{mA}$   
 Duration of Short Circuit Between  
   OUT\_ and PVDD, PGND ..... Continuous  
   OUT+ and OUT- ..... Continuous

Continuous Power Dissipation ( $T_A = +70^\circ\text{C}$ ) for Multilayer Board  
   9-Bump WLP (derate 10.6mW/ $^\circ\text{C}$ ) .....848mW  
 Junction Temperature .....+150 $^\circ\text{C}$   
 Operating Temperature Range.....-40 $^\circ\text{C}$  to +85 $^\circ\text{C}$   
 Storage Temperature Range.....-65 $^\circ\text{C}$  to +150 $^\circ\text{C}$   
 Soldering Temperature (reflow) .....+260 $^\circ\text{C}$

*Stresses beyond those listed under "Absolute Maximum Ratings" may cause permanent damage to the device. These are stress ratings only, and functional operation of the device at these or any other conditions beyond those indicated in the operational sections of the specifications is not implied. Exposure to absolute maximum rating conditions for extended periods may affect device reliability.*

### ELECTRICAL CHARACTERISTICS

(VPVDD =  $\overline{\text{VSHDN}}$  = 5.0V, VPGND = 0V, Av = 12dB (GAIN = PGND), RL =  $\infty$ , RL connected between OUT+ to OUT-, AC measurement bandwidth 20Hz to 22kHz, TA = TMIN to TMAX, unless otherwise noted. Typical values are at TA = +25 $^\circ\text{C}$ .) (Notes 1, 2)

PARAMETER	SYMBOL	CONDITIONS	MIN	TYP	MAX	UNITS
Supply Voltage Range	PVDD	Inferred from PSRR test	2.5		5.5	V
Undervoltage Lockout	UVLO	PVDD falling	1.5	1.8	2.2	V
Quiescent Supply Current	IDD	TA = +25 $^\circ\text{C}$		1.2	1.8	mA
		VPVDD = 3.7V		0.95		
Shutdown Supply Current	ISHDN	$\overline{\text{VSHDN}}$ = 0V, TA = +25 $^\circ\text{C}$		< 0.1	10	$\mu\text{A}$
Turn-On Time	tON			3.4	10	ms
Bias Voltage	VBIAS			VPVDD / 2		V
Input Resistance	RIN	TA = +25 $^\circ\text{C}$ , single-ended	Av = 12dB	45	70	k $\Omega$
			Av = 9dB	64	100	
			Av = 6dB	90	140	
			Av = 3dB	128	200	
			Av = 0dB	180	280	
Voltage Gain	Av	Connect GAIN to PGND	11.5	12	12.5	dB
		Connect GAIN to PGND through 100k $\Omega$ $\pm 5\%$	8.5	9	9.5	
		Connect GAIN to PVDD	5.5	6	6.5	
		Connect GAIN to PVDD through 100k $\Omega$ $\pm 5\%$	2.5	3	3.5	
		GAIN unconnected	-0.5	0	+0.5	
Output Offset Voltage	VOS	TA = +25 $^\circ\text{C}$ (Note 3)		$\pm 1$	$\pm 4.5$	mV
Click and Pop	KCP	Peak voltage, A-weighted, 32 samples per second, RL = 8 $\Omega$ (Notes 3, 4)	Into shutdown		-74	dBV
			Out of shutdown		-60	
Common-Mode Rejection Ratio	CMRR	fIN = 1kHz, input referred		80		dB

# MAX98304

## Mono 3.2W Class D Amplifier

### ELECTRICAL CHARACTERISTICS (continued)

(VPVDD = VSHDN = 5.0V, VPGND = 0V, AV = 12dB (GAIN = PGND), RL = ∞, RL connected between OUT+ to OUT-, AC measurement bandwidth 20Hz to 22kHz, TA = TMIN to TMAX, unless otherwise noted. Typical values are at TA = +25°C.) (Notes 1, 2)

PARAMETER	SYMBOL	CONDITIONS	MIN	TYP	MAX	UNITS	
Power-Supply Rejection Ratio (Note 3)	PSRR	VPVDD = 2.5V to 5.5V, TA = +25°C		72	90	dB	
			f = 217Hz		80		
		VRIPPLE = 200mVP-P	f = 1kHz		84		
			f = 20kHz		84		
Output Power	POUT	THD+N = 10%, f = 1kHz, RL = 4Ω + 33μH	VPVDD = 5.0V		3.2	W	
			VPVDD = 4.2V		2.2		
			VPVDD = 3.7V		1.7		
		THD+N = 1%, f = 1kHz, RL = 4Ω + 33μH	VPVDD = 5.0V		2.6		
			VPVDD = 4.2V		1.8		
			VPVDD = 3.7V		1.4		
		THD+N = 10%, f = 1kHz, RL = 8Ω + 68μH	VPVDD = 5.0V		1.8		
			VPVDD = 4.2V		1.2		
			VPVDD = 3.7V		0.96		
		THD+N = 1%, f = 1kHz, RL = 8Ω + 68μH	VPVDD = 5.0V		1.4		
			VPVDD = 4.2V		1		
			VPVDD = 3.7V		0.8		
Total Harmonic Distortion Plus Noise	THD+N	fIN = 1kHz	RL = 4Ω POUT = 1W		0.03	0.1	%
			RL = 8Ω POUT = 0.7W		0.03		
Oscillator Frequency	fOSC			300		kHz	
Spread-Spectrum Bandwidth				±12.5		kHz	
Efficiency	η	POUT = 1.75W, RL = 8Ω		93		%	
Noise	VN	A-weighted (Note 3)	AV = 12dB		31	μVRMS	
			AV = 9dB		26		
			AV = 6dB		23		
			AV = 3dB		21		
			AV = 0dB		19		
Output Current Limit	ILIM			2.8		A	
Thermal Shutdown Level				155		°C	
Thermal Shutdown Hysteresis				15		°C	
<b>DIGITAL INPUT (SHDN)</b>							
Input-Voltage High	VINH	VPVDD = 2.5V to 5.5V		1.4		V	
Input-Voltage Low	VINL	VPVDD = 2.5V to 5.5V			0.4	V	
Input Leakage Current		TA = +25°C			±1	μA	

**Note 1:** This device is 100% production tested at +25°C. All temperature limits are guaranteed by design.

**Note 2:** Testing performed with a resistive load in series with an inductor to simulate an actual speaker load. For RL = 4Ω, L = 33μH. For RL = 8Ω, L = 68μH.

**Note 3:** Amplifier inputs AC-coupled to ground.

**Note 4:** Mode transitions controlled by SHDN.

# MAX98304

## Mono 3.2W Class D Amplifier

### Typical Operating Characteristics

( $V_{PVDD} = V_{SHDN} = 5.0V$ ,  $V_{PGND} = 0V$ ,  $A_V = 6dB$ ,  $R_L = \infty$ ,  $R_L$  connected between  $OUT+$  to  $OUT-$ , AC measurement bandwidth 20Hz to 22kHz,  $T_A = +25^\circ C$ , unless otherwise noted.)

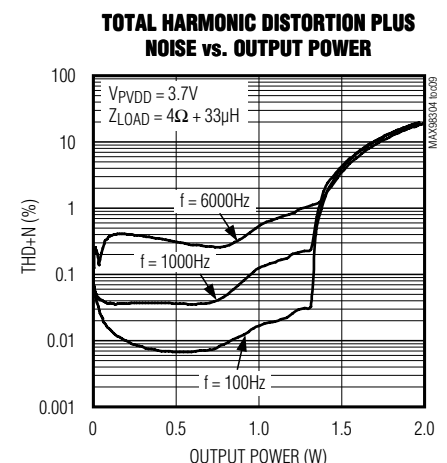
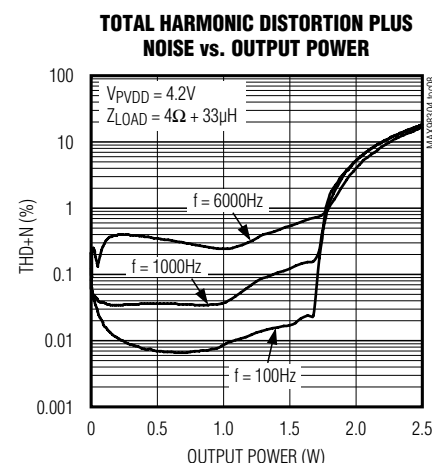
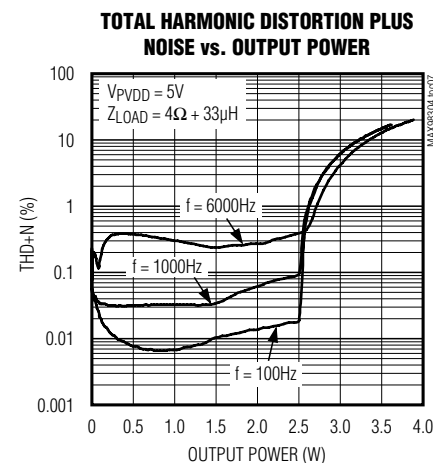
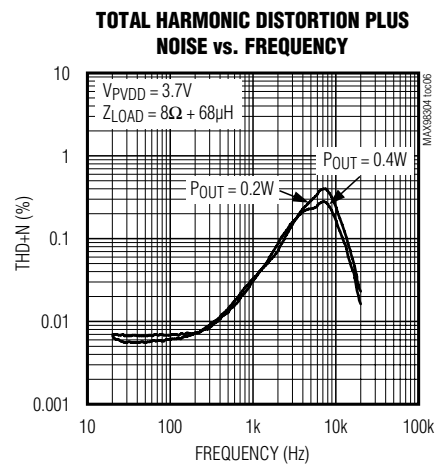
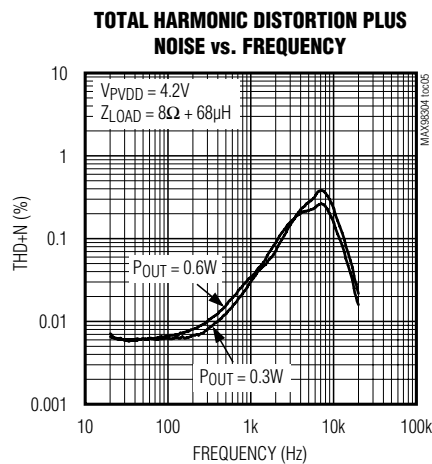
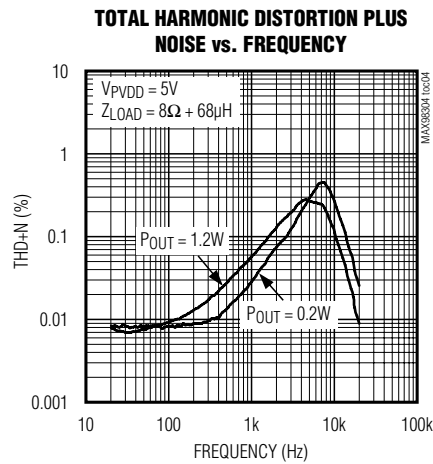
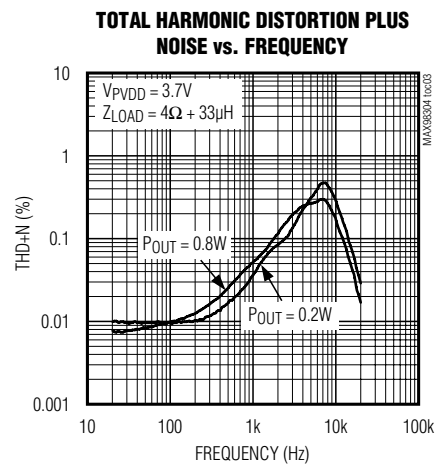
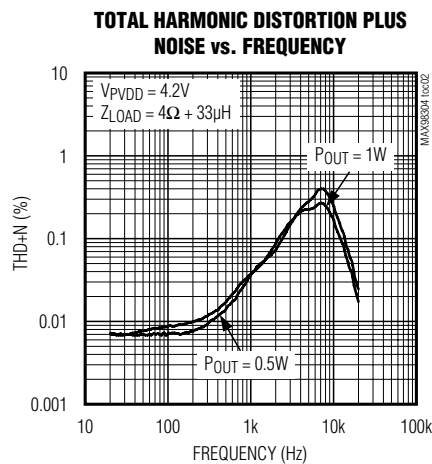
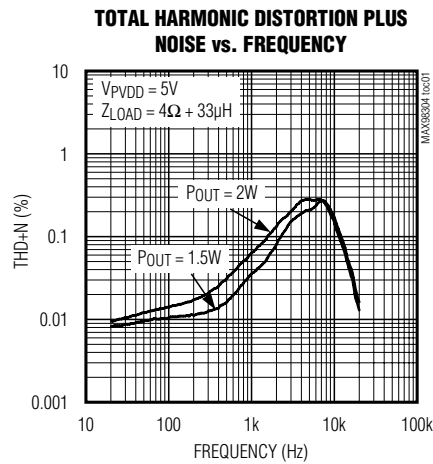

# MAX98304

## Mono 3.2W Class D Amplifier

### Typical Operating Characteristics (continued)

( $V_{PVDD} = V_{SHDN} = 5.0V$ ,  $V_{PGND} = 0V$ ,  $A_V = 6dB$ ,  $R_L = \infty$ ,  $R_L$  connected between  $OUT+$  to  $OUT-$ , AC measurement bandwidth 20Hz to 22kHz,  $T_A = +25^\circ C$ , unless otherwise noted.)

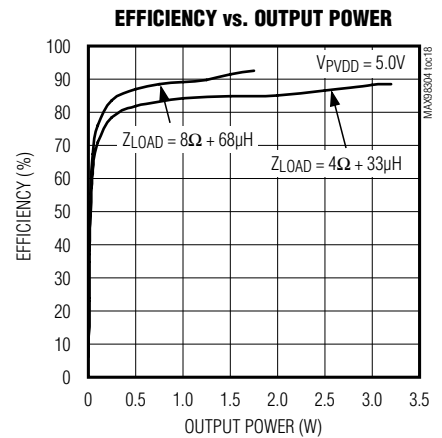
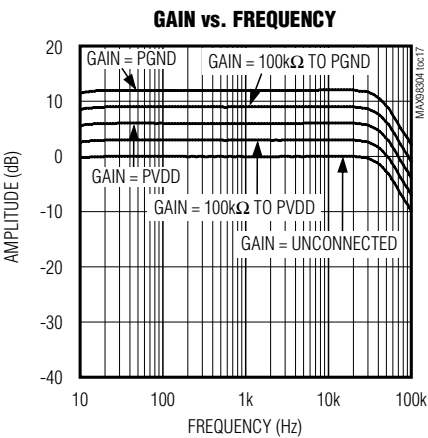
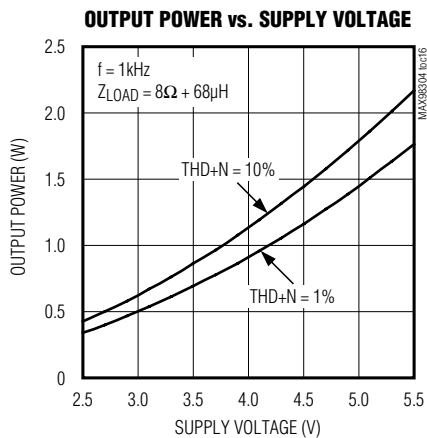
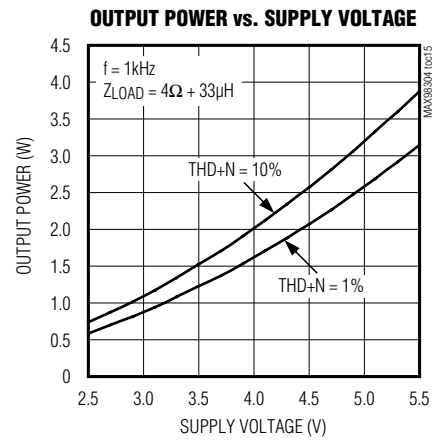
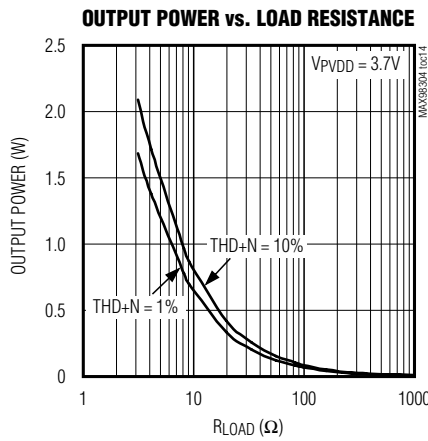
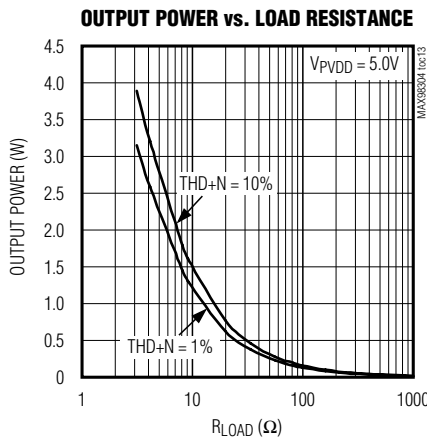
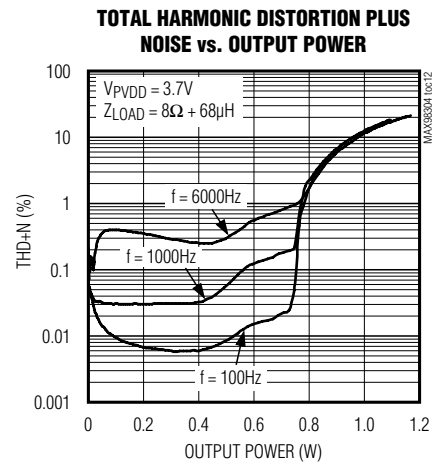
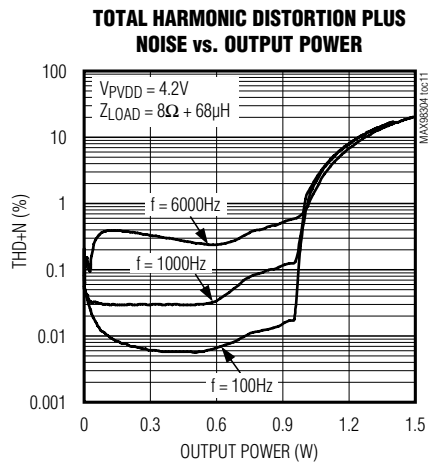
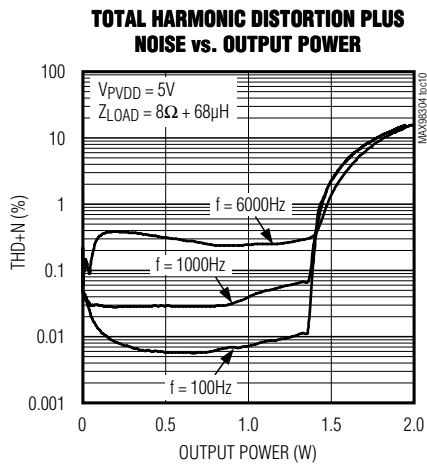

# MAX98304

## Mono 3.2W Class D Amplifier

### Typical Operating Characteristics (continued)

( $V_{PVDD} = V_{SHDN} = 5.0V$ ,  $V_{PGND} = 0V$ ,  $A_v = 6dB$ ,  $R_L = \infty$ ,  $R_L$  connected between  $OUT+$  to  $OUT-$ , AC measurement bandwidth 20Hz to 22kHz,  $T_A = +25^\circ C$ , unless otherwise noted.)

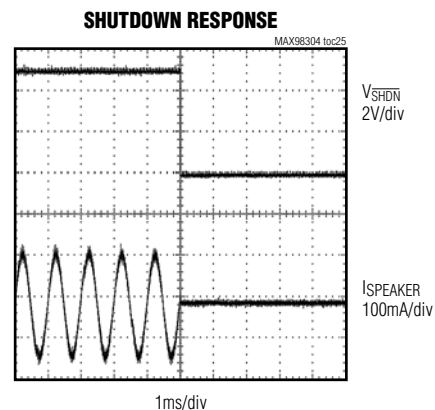
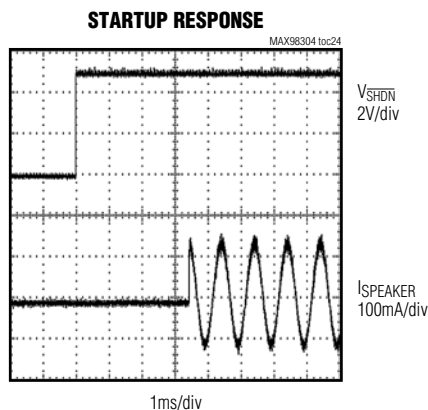
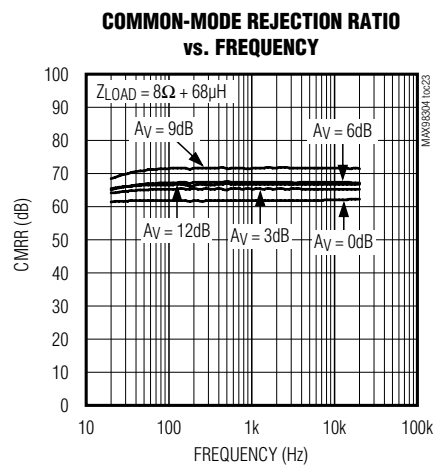
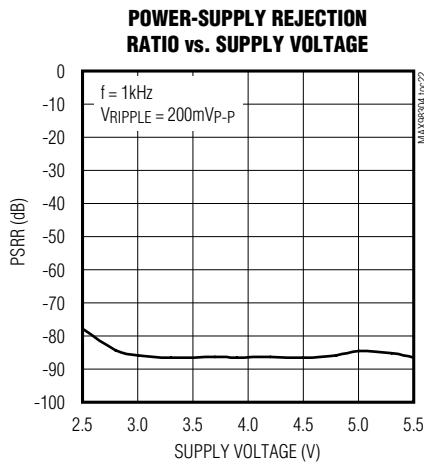
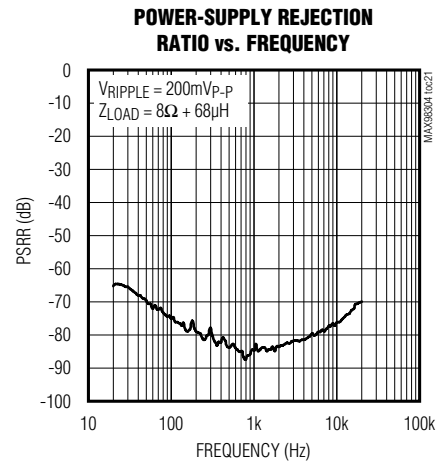
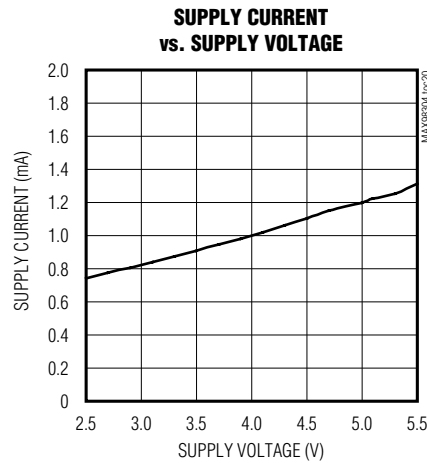
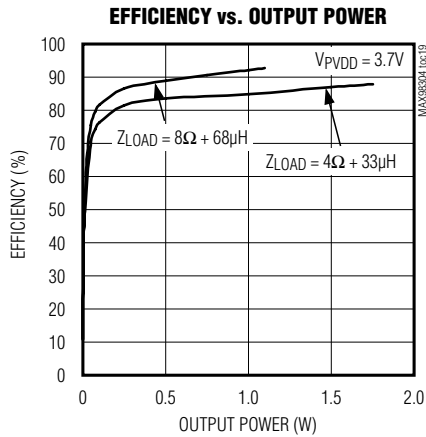

# MAX98304

## Mono 3.2W Class D Amplifier

### Typical Operating Characteristics (continued)

( $V_{PVDD} = V_{SHDN} = 5.0V$ ,  $V_{PGND} = 0V$ ,  $A_V = 6dB$ ,  $R_L = \infty$ ,  $R_L$  connected between  $OUT+$  to  $OUT-$ , AC measurement bandwidth 20Hz to 22kHz,  $T_A = +25^\circ C$ , unless otherwise noted.)

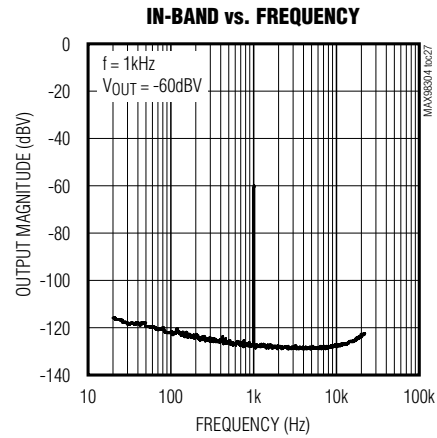
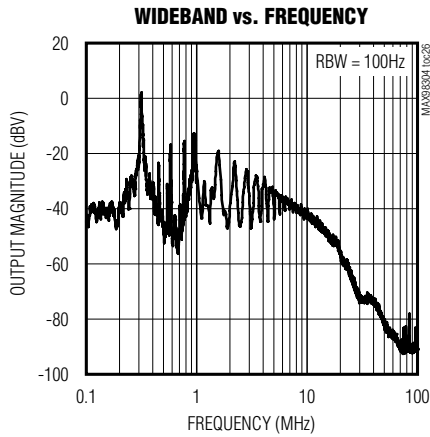

### Bump Configuration

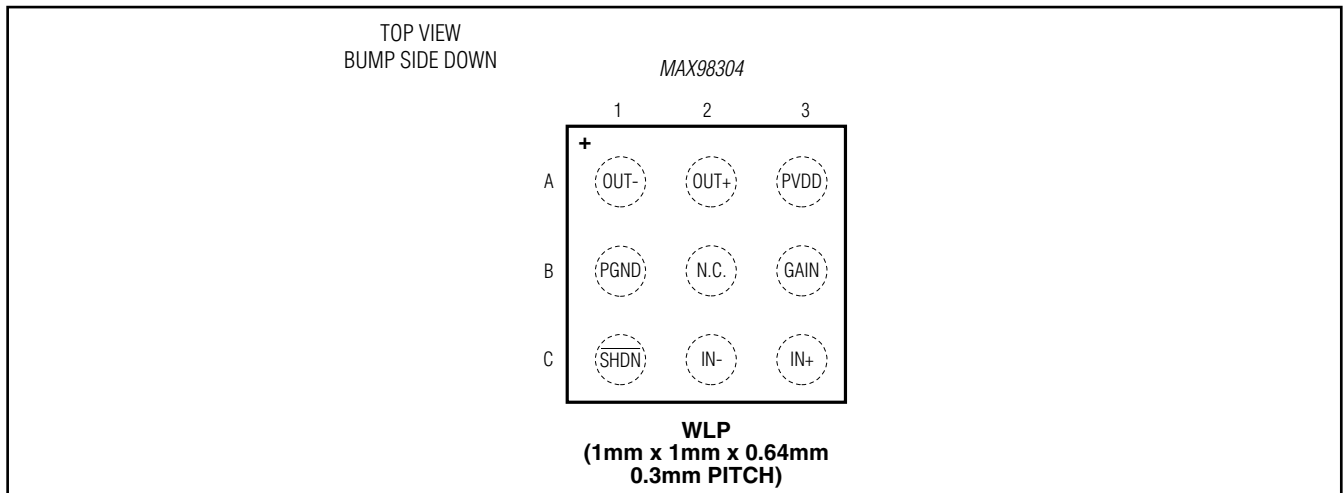

### Bump Description

BUMP	NAME	FUNCTION
A1	OUT-	Negative Speaker Output
A2	OUT+	Positive Speaker Output
A3	PVDD	Power Supply. Bypass PVDD to PGND with 0.1 $\mu$ F    10 $\mu$ F.
B1	PGND	Ground
B2	N.C.	No Connection. Can be left unconnected, or connected to PGND.
B3	GAIN	Gain Select. See Table 1 for GAIN settings.
C1	SHDN	Active-Low Shutdown Input. Drive SHDN low to place the device in shutdown.
C2	IN-	Inverting Audio Input
C3	IN+	Noninverting Audio Input

# MAX98304

## Mono 3.2W Class D Amplifier

### Detailed Description

The MAX98304 features low quiescent current, a low-power shutdown mode, comprehensive click-and-pop suppression, and excellent RF immunity.

The device offers Class AB audio performance with Class D efficiency in a minimal board-space solution.

The Class D amplifier features spread-spectrum modulation, edge-rate, and overshoot control circuitry that offers significant improvements to switch-mode amplifier radiated emissions.

The amplifier features click-and-pop suppression that reduces audible transients on startup and shutdown. The amplifier includes thermal overload and short-circuit protection.

### Class D Speaker Amplifier

The filterless Class D amplifier offers much higher efficiency than Class AB amplifiers. The high efficiency of a Class D amplifier is due to the switching operation of the output stage transistors. Any power loss associated with the Class D output stage is mostly due to the  $I^2R$  loss of the MOSFET on-resistance and quiescent current overhead.

### Ultra-Low EMI Filterless Output Stage

Traditional Class D amplifiers require the use of external LC filters, or shielding, to meet EN55022B electromagnetic-interference (EMI) regulation standards. Maxim's patented active emissions-limiting edge-rate control circuitry and spread-spectrum modulation reduces EMI emissions, while maintaining up to 93% efficiency.

Maxim's patented spread-spectrum modulation mode flattens wideband spectral components, while proprietary techniques ensure that the cycle-to-cycle variation of the switching period does not degrade audio reproduction or efficiency. The IC's spread-spectrum modulator randomly varies the switching frequency by  $\pm 12.5\text{kHz}$  around the center frequency (300kHz). Above 10MHz, the wideband spectrum looks like noise for EMI purposes (Figure 1).

### Speaker Current Limit

If the output current of the speaker amplifier exceeds the current limit (2.8A typ), the IC disables the outputs for approximately 100 $\mu\text{s}$ . At the end of 100 $\mu\text{s}$ , the outputs are reenabled. If the fault condition still exists, the IC continues to disable and reenable the outputs until the fault condition is removed.

### Selectable Gain

The IC offers five programmable gain selections through a single gain input (GAIN).

Table 1. Gain Control Configuration

GAIN PIN	MAXIMUM GAIN (dB)
Connect to PGND	12
Connect to PGND through 100k $\Omega$ $\pm 5\%$ resistor	9
Connect to PVDD	6
Connect to PVDD through 100k $\Omega$ $\pm 5\%$ resistor	3
Unconnected	0

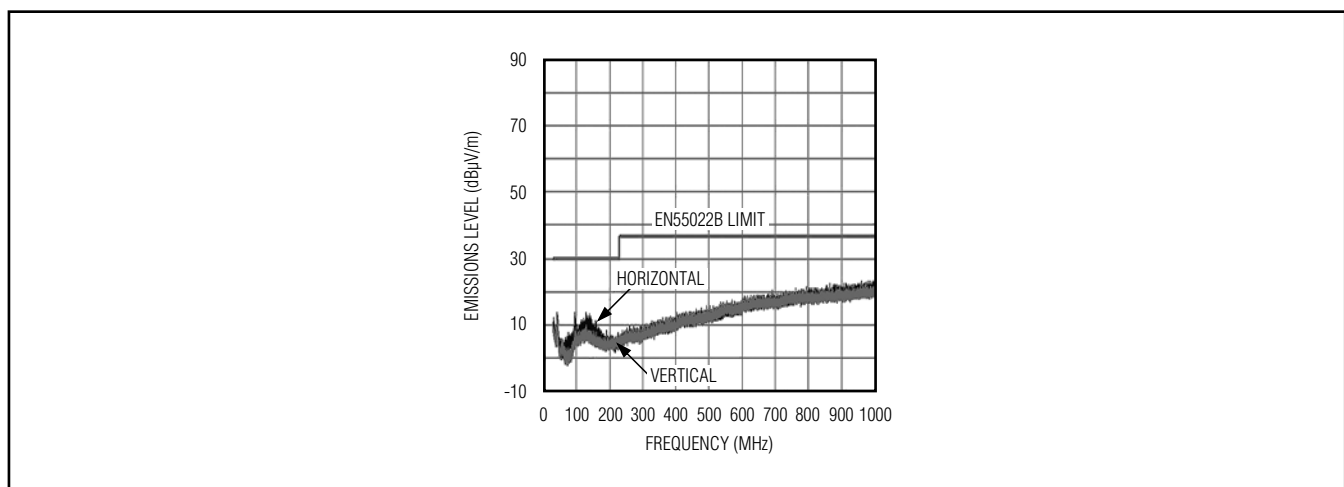

Figure 1. EMI with 60cm of Speaker Cable and No Output Filtering

## Mono 3.2W Class D Amplifier

### Shutdown

The IC features a low-power shutdown mode, drawing less than 0.1µA (typ) of supply current. Drive SHDN low to put the IC into shutdown.

### Click-and-Pop Suppression

The IC speaker amplifier features Maxim's comprehensive click-and-pop suppression. During startup, the click-and-pop suppression circuitry reduces any audible transient sources internal to the device. When entering shutdown, the differential speaker outputs ramp down to PGND quickly and simultaneously.

### Applications Information

#### Filterless Class D Operation

Traditional Class D amplifiers require an output filter. The filter adds cost, size, and decreases efficiency and THD+N performance. The IC's filterless modulation scheme does not require an output filter.

Because the switching frequency of the IC is well beyond the bandwidth of most speakers, voice coil movement due to the switching frequency is very small. Use a speaker with a series inductance > 10µH. Typical 8Ω speakers exhibit series inductances in the 20µH to 100µH range.

#### Component Selection

##### Power-Supply Input (PVDD)

PVDD powers the speaker amplifier. PVDD ranges from 2.5V to 5.5V. Bypass PVDD with a 0.1µF and 10µF capacitor to PGND. Apply additional bulk capacitance at the device if long input traces between PVDD and the power source are used.

##### Input Filtering

The input-coupling capacitor ( $C_{IN}$ ), in conjunction with the amplifier's internal input resistance ( $R_{IN}$ ), forms a high-pass filter that removes the DC bias from the incoming signal. These capacitors allow the amplifier to bias the signal to an optimum DC level.

Assuming zero source impedance  $C_{IN}$  is:

$$C_{IN} = \frac{2\pi \times R_{IN}}{f_{-3dB}} [\mu F]$$

where  $f_{-3dB}$  is the -3dB corner frequency and  $R_{IN}$  is the input resistance shown in the *Electrical Characteristics* table. Use capacitors with adequately low voltage-coefficient for best low-frequency THD performance.

### Layout and Grounding

Proper layout and grounding are essential for optimum performance. Good grounding improves audio performance and prevents switching noise from coupling into the audio signal.

Use wide, low-resistance output traces. As the load impedance decreases, the current drawn from the device increases. At higher current, the resistance of the output traces decreases the power delivered to the load. For example, if 2W is delivered from the device output to a 4Ω load through 100mΩ of total speaker trace, 1.904W is being delivered to the speaker. If power is delivered through 10mΩ of total speaker trace, 1.99W is being delivered to the speaker. Wide output, supply, and ground traces also improve the power dissipation of the device.

The IC is inherently designed for excellent RF immunity. For best performance, add ground fills around all signal traces on top or bottom PCB planes.

### WLP Applications Information

For the latest application details on WLP construction, dimensions, tape carrier information, PCB techniques, bump-pad layout, and recommended reflow temperature profile, as well as the latest information on reliability testing results, refer to Application Note 1891: *Wafer-level packaging (WLP) and its applications*. Figure 2 shows the dimensions of the WLP balls used on the IC.

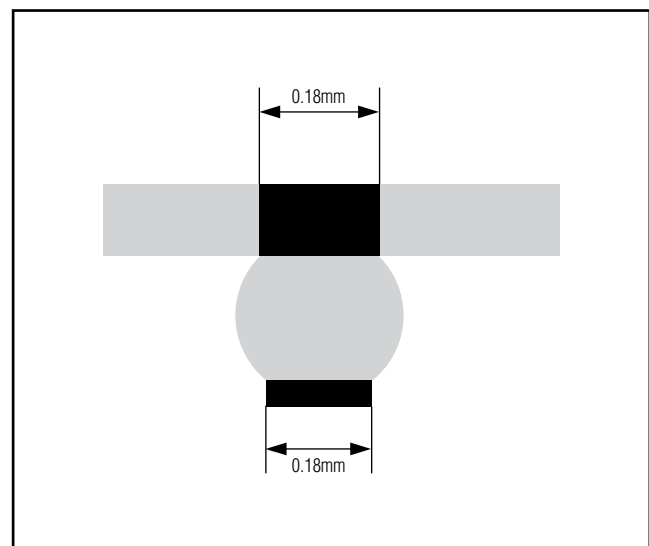
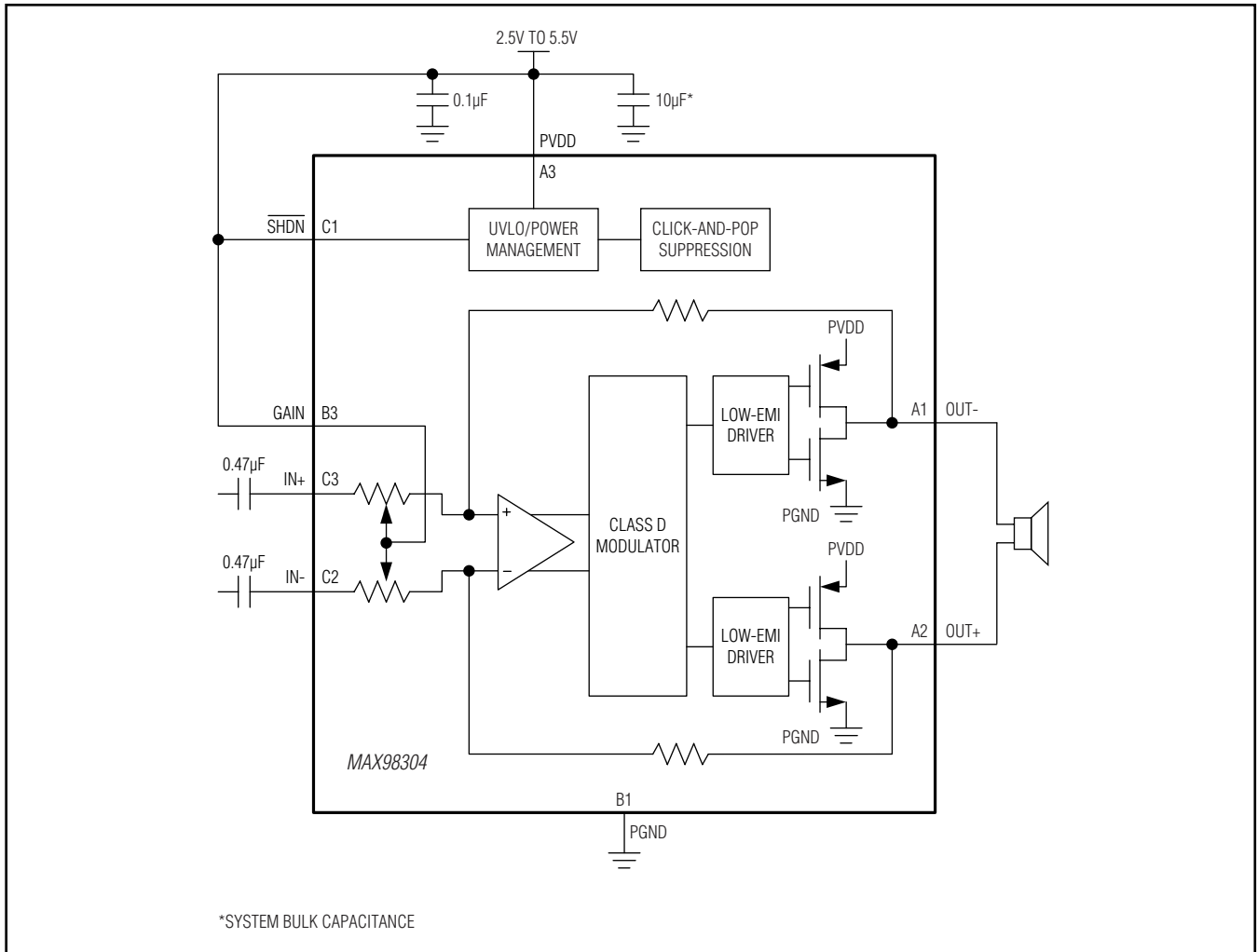

Figure 2. MAX98304 WLP Ball Dimensions

# MAX98304

## Mono 3.2W Class D Amplifier

### Functional Diagram



### Chip Information

PROCESS: CMOS



# MAX98304

## Mono 3.2W Class D Amplifier

### Revision History



REVISION NUMBER	REVISION DATE	DESCRIPTION	PAGES CHANGED
0	9/10	Initial release	—



Maxim Integrated cannot assume responsibility for use of any circuitry other than circuitry entirely embodied in a Maxim Integrated product. No circuit patent licenses are implied. Maxim Integrated reserves the right to change the circuitry and specifications without notice at any time. The parametric values (min and max limits) shown in the Electrical Characteristics table are guaranteed. Other parametric values quoted in this data sheet are provided for guidance.

## Looking for pricing, stock, or lifecycle information?

Click below to explore more details on WIN SOURCE:

-  [View MAX98304EWL+T on WIN SOURCE](#)
-  [Analog Devices Inc. Information](#)

## Optimize Your Supply Chain with WIN SOURCE Solutions

-  Global Sourcing Solution
-  Obsolete Management
-  Cost Control Management
-  Shortage Management
-  Alternative Solution
-  Excess Inventory Management