



**THE DATASHEET OF
MAX9727EEP+**



Quad Audio Line Driver with 3V_{RMS} Output

General Description

The MAX9727 quad audio line driver with 3V_{RMS} output is ideal for portable audio devices where board space and cost is at a premium. The device uses Maxim's DirectDrive™ architecture that produces a ground-referenced output from a single supply, eliminating the need for large DC-blocking capacitors and saving cost, board space, and component height. A high 100dB PSRR and low 0.0005% THD+N ensures clean, low-distortion amplification of the audio signal. Each MAX9727 amplifier can provide 3V_{RMS} to a 1kΩ load with less than 0.003% THD+N while operating from a single +5V supply. Each MAX9727 amplifier can provide 2V_{RMS} to a 1kΩ load with less than 0.003% THD+N while operating from a single +3.3V supply.

A shutdown input disables the amplifiers and reduces quiescent current consumption to less than 100nA. The MAX9727 features Maxim's comprehensive click-and-pop suppression circuitry that reduces audible clicks and pops during startup and shutdown.

The MAX9727 operates from a single 2.7V to 5.5V supply, consumes only 3mA of supply current per channel, and is specified over the -40°C to +85°C extended temperature range.

Applications

Set-Top Boxes
Consumer and Professional Audio Equipment
A/V Receivers
CD and DVD Players
Soundcards
Portable Audio Devices

Pin Configuration

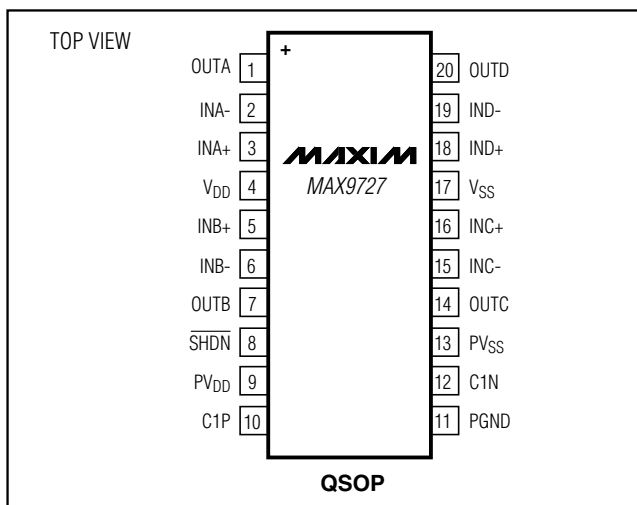

Features

- ◆ 2.7V to 5.5V Single-Supply Operation
- ◆ High 100dB PSRR
- ◆ 109dB Signal-to-Noise Ratio (SNR)
- ◆ Ground-Referenced Outputs
- ◆ No Audible Clicks or Pops at Power-Up/Down
- ◆ Differential Inputs
- ◆ 3V_{RMS} into 1kΩ Load at 5V
- ◆ 2V_{RMS} into 1kΩ Load at 3.3V
- ◆ 3mA Supply Current Per Channel
- ◆ Unity-Gain Stable
- ◆ 100nA Low-Power Shutdown Mode
- ◆ C_{LOAD} Drive > 220pF
- ◆ ±8kV HBM ESD-Protected Outputs

Ordering Information

PART	TEMP RANGE	PIN-PACKAGE	GAIN
MAX9727EEP+	-40°C to +85°C	20 QSOP	Adjustable

+ Denotes lead-free package.

Simplified Block Diagram

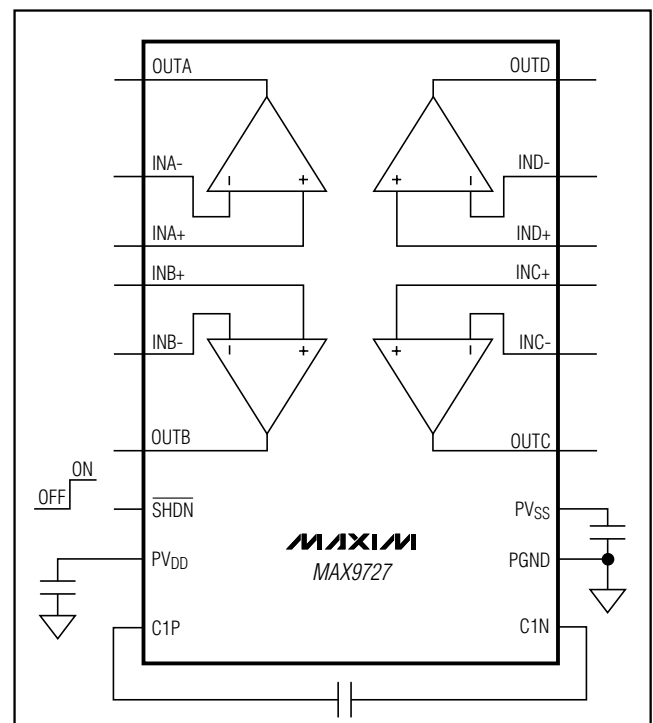

Quad Audio Line Driver with 3VRMS Output

ABSOLUTE MAXIMUM RATINGS

V _{DD} , PV _{DD} to PGND	-0.3V to +6V	Continuous Power Dissipation (T _A = +70°C)
V _{SS} , PV _{SS} to PGND	-6V to +0.3V	20-Pin QSOP Single-Layer Board
IN ₋ to PGND	(V _{SS} + 0.3V) to (PV _{DD} - 0.3V)	(derate 9.1mW/°C above +70°C)
OUT ₋ to PGND	(V _{SS} - 0.3V) to (PV _{DD} + 0.3V)	20-Pin QSOP Multilayer Board
SHDN to PGND	(PGND - 0.3V) to (PV _{DD} + 0.3V)	(derate 11mW/°C above +70°C)
C1P to PGND	(PGND - 0.3V) to (PV _{DD} + 0.3V)	Operating Temperature Range
C1N to PGND	(PV _{SS} - 0.3V) to (PGND + 0.3V)	Junction Temperature
Output Short Circuit to PGND or PV _{DD}	Continuous	Storage Temperature Range
		Lead Temperature (soldering, 10s)

Stresses beyond those listed under "Absolute Maximum Ratings" may cause permanent damage to the device. These are stress ratings only, and functional operation of the device at these or any other conditions beyond those indicated in the operational sections of the specifications is not implied. Exposure to absolute maximum rating conditions for extended periods may affect device reliability.

ELECTRICAL CHARACTERISTICS

(V_{DD} = PV_{DD} = 3.3V, PGND = 0V, SHDN = V_{DD}, V_{CM} = 0V, C1 = C2 = 1μF, R_{IN} = R_F = 5kΩ, R_L = ∞, T_A = T_{MIN} to T_{MAX}. Typical values are at T_A = +25°C.) (Note 1)

PARAMETER	SYMBOL	CONDITIONS	MIN	TYP	MAX	UNITS
GENERAL						
Supply Voltage Range	V _{DD}	Inferred from PSRR test	2.7		5.5	V
Quiescent Current	I _{DD}	Current into V _{DD} and PV _{DD}		12	14	mA
Shutdown Current	I _{DD} , SHDN	V _{SHDN} = 0V		0.1	10	μA
AMPLIFIERS						
Input Offset Voltage	V _{OS}			±0.5	±5	mV
Input Bias Current	I _{BIAS}			1000		nA
Input Offset Current	I _{OS}			500		nA
Open-Loop Gain	A _v	V _{OUT} = -3V to +3V, R _L = 1kΩ		82		dB
Input Common-Mode Voltage Range	CMR	V _{DD} = 2.7V	-1.6		+1.6	V
		V _{DD} = 3V	-2.3		+2.3	
		V _{DD} = 5V	-3.5		+3.5	
Common-Mode Rejection Ratio	CMRR	V _{DD} = 2.7V, V _{CM} = ±1.6V	80	100		dB
		V _{DD} = 3V, V _{CM} = ±1.9V	80	100		
		V _{DD} = 5V, V _{CM} = ±3.5V	80	100		
Power-Supply Rejection Ratio	PSRR	V _{DD} = PV _{DD} = 2.7V to 5.5V	80	100		dB
		f = 1kHz, V _{DD} = PV _{DD} = 5V + 100mVp-p ripple		60		
Output Voltage		R _L = 1kΩ, V _{DD} = 3.3V, THD+N = 1%	1.6	2.0		V _{RMS}
		R _L = 1kΩ, V _{DD} = 5V, THD+N = 1%	2.0	3.0		
Output Voltage Swing	V _{OUT}	R _L = 1kΩ, V _{DD} = 3.3V	Positive	2.6	3.0	V
			Negative	-2.6	-3.0	
		R _L = 1kΩ, V _{DD} = 5V	Positive	3.5	4.2	
			Negative	-3.5	-4.1	
Output Short-Circuit Current	I _{SC}	Sinking		40		mA
		Sourcing		5		

Quad Audio Line Driver with 3V_{RMS} Output

ELECTRICAL CHARACTERISTICS

(V_{DD} = PV_{DD} = 3.3V, PGND = 0V, $\overline{\text{SHDN}}$ = V_{DD}, V_{CM} = 0V, C₁ = C₂ = 1μF, R_{IN} = R_F = 5kΩ, R_L = ∞, T_A = T_{MIN} to T_{MAX}. Typical values are at T_A = +25°C.) (Note 1)

PARAMETER	SYMBOL	CONDITIONS	MIN	TYP	MAX	UNITS
Total Harmonic Distortion Plus Noise	THD+N	V _{OUT} = 1.6V _{RMS} , BW = 22Hz to 22kHz, f = 1kHz, unweighted, R _L = 10kΩ		0.0005		%
		V _{OUT} = 2V _{RMS} , BW = 22Hz to 22kHz, f = 1kHz, unweighted, R _L = 10kΩ		0.0006		
		V _{OUT} = 1.6V _{RMS} , BW = 22Hz to 22kHz, f = 1kHz, unweighted, R _L = 1kΩ		0.003		
Signal-to-Noise Ratio	SNR	V _{OUT} = 1.6V _{RMS} , R _L = 1kΩ	22Hz to 22kHz	109		dB
			A-weighted	113.6		
		V _{OUT} = 2V _{RMS} , R _L = 1kΩ	22Hz to 22kHz	111		
			A-weighted	115.5		
Click-and-Pop Level	K _{CP}	Peak voltage, A-weighted, 32 samples/s (Notes 2, 3)	Into shutdown	-62.2		dBV
			Out of shutdown	-54.3		
Slew Rate		R _L = 1kΩ, C _L = 100pF		0.9		V/μs
Turn-On Time	t _{ON}			90		μs
Turn-Off Time	t _{OFF}			1		μs
Capacitive Drive	C _L	No sustained oscillations		220		pF
Crosstalk		f = 10kHz		-70		dB
Large-Signal Open-Loop Gain	A _{VOL}	V _{OUT} = 2V _{RMS}		82		dB
Small-Signal Open-Loop Gain	A _{VOS}	V _{OUT} = 100mV _{RMS}		95		dB
Gain Bandwidth	GBW			3		MHz
Charge-Pump Switching Frequency	f _{OSC}		150	300	450	kHz
Charge-Pump Output Impedance		Measured at PV _{SS}		20		Ω
ESD Protection	ESD	HBM		±8		kV
DIGITAL INPUTS ($\overline{\text{SHDN}}$)						
Input-Voltage High	V _{IH}		2.0			V
Input-Voltage Low	V _{IL}				0.8	V
Input Leakage Current	I _{LEAK}				±1	μA

Note 1: All devices are 100% tested at T_A = +25°C. Specifications over temperature are guaranteed by design.

Note 2: Inputs AC-coupled to PGND.

Note 3: Click-and-pop testing performed with a 1kΩ resistive load connected to ground. Mode transitions are controlled by $\overline{\text{SHDN}}$. K_{CP} level is calculated as 20log[(peak voltage during mode transition, no input signal)/1V_{RMS}]. Units are expressed in dBV.

Quad Audio Line Driver with 3VRMS Output

Typical Operating Characteristics

($V_{DD} = PV_{DD} = 3.3V$, $V_{CM} = 0V$, $R_{IN} = R_F = 5k\Omega$, THD+N measurement bandwidth = 22Hz to 22kHz, $T_A = +25^\circ C$, unless otherwise noted.)

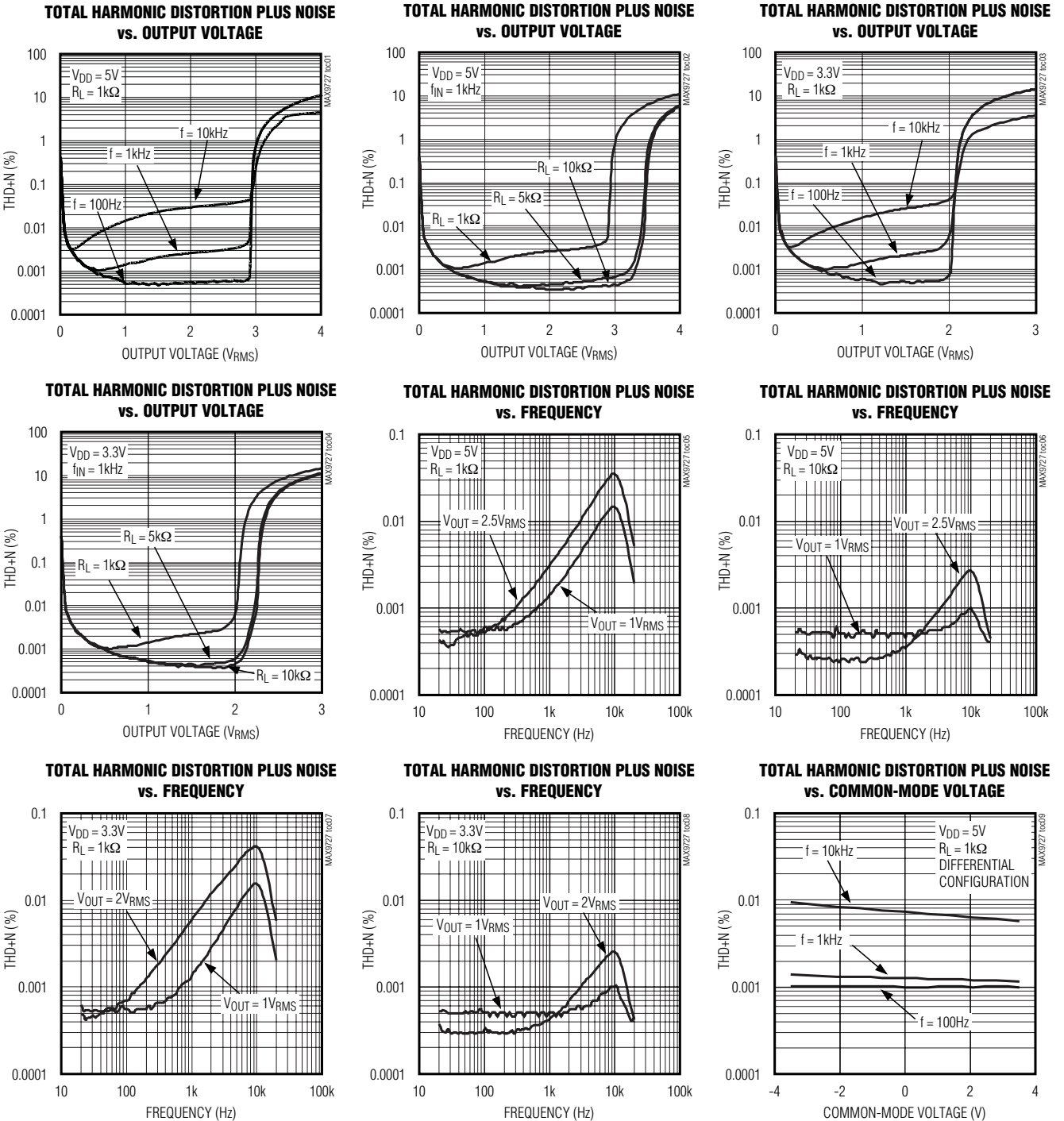

Quad Audio Line Driver with 3V_{RMS} Output

Typical Operating Characteristics (continued)

($V_{DD} = PV_{DD} = 3.3V$, $V_{CM} = 0V$, $R_{IN} = R_F = 5k\Omega$, THD+N measurement bandwidth = 22Hz to 22kHz, $T_A = +25^\circ C$, unless otherwise noted.)

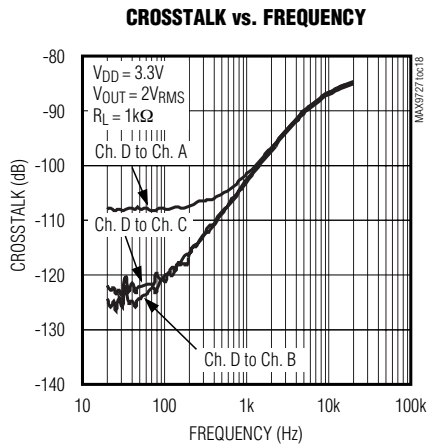
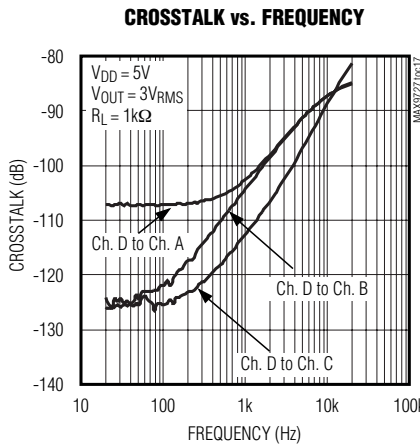
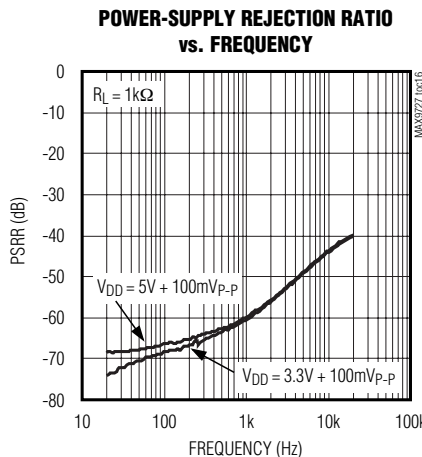
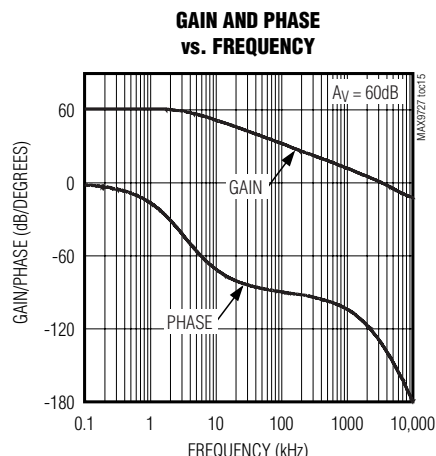
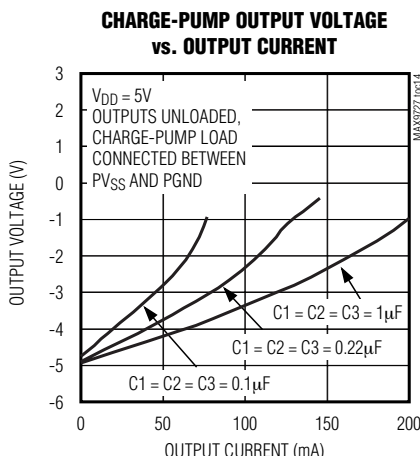
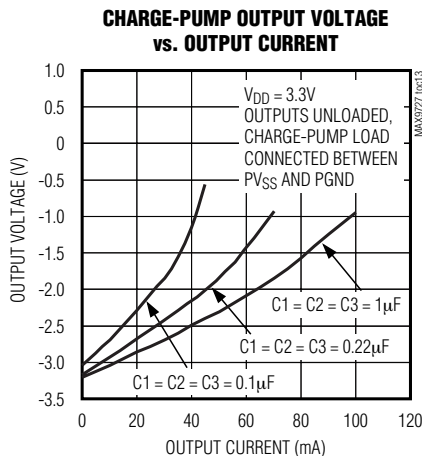
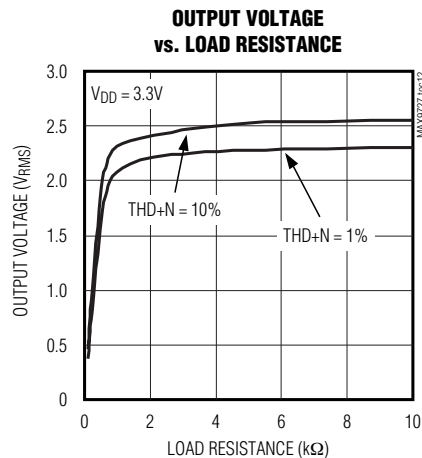
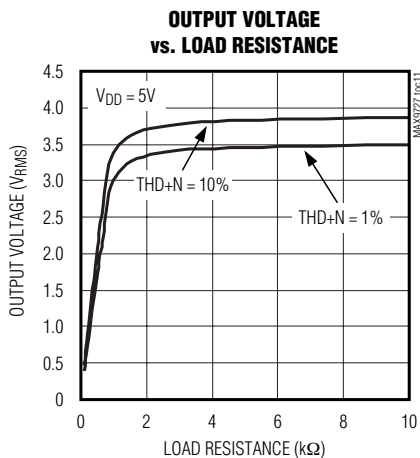
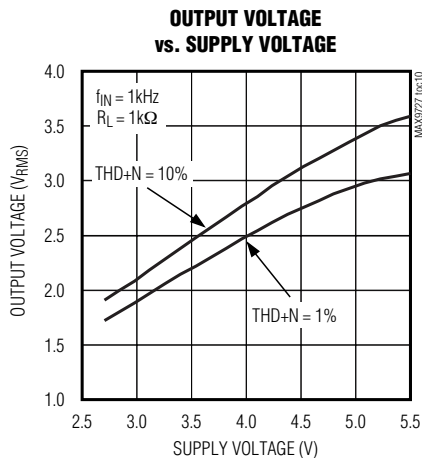

Quad Audio Line Driver with 3VRMS Output

Typical Operating Characteristics (continued)

($V_{DD} = PV_{DD} = 3.3V$, $V_{CM} = 0V$, $R_{IN} = R_F = 5k\Omega$, THD+N measurement bandwidth = 22Hz to 22kHz, $T_A = +25^\circ C$, unless otherwise noted.)

ENTERING SHUTDOWN

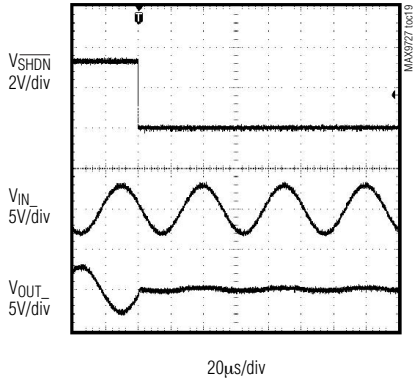

EXITING SHUTDOWN

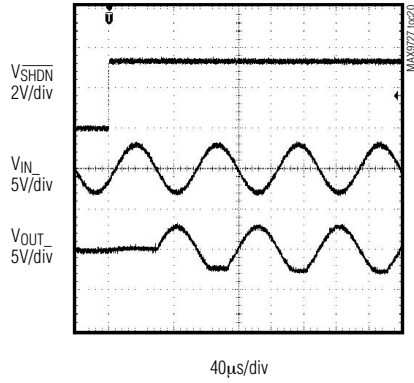

OUTPUT AT 2VRMS AT 1kHz
($V_{DD} = 5V$, $R_L = 1k\Omega$)

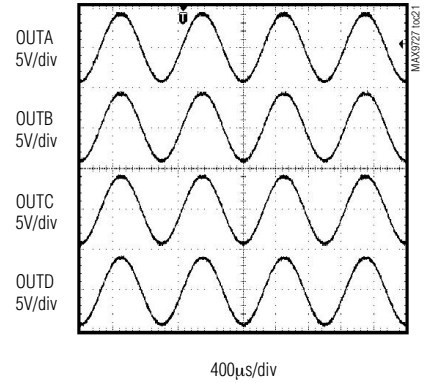

STEP RESPONSE

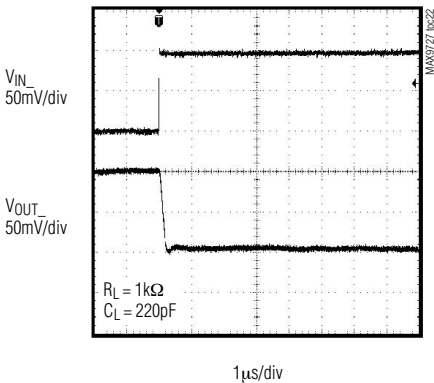

STEP RESPONSE

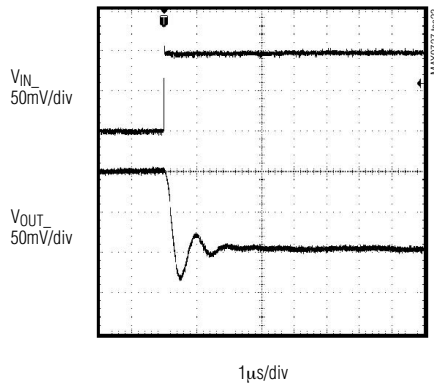

SUPPLY CURRENT vs. TEMPERATURE

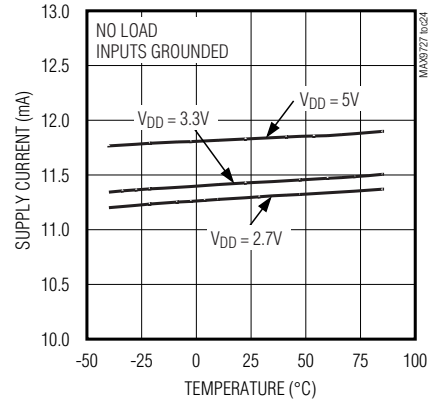

SHUTDOWN CURRENT vs. TEMPERATURE

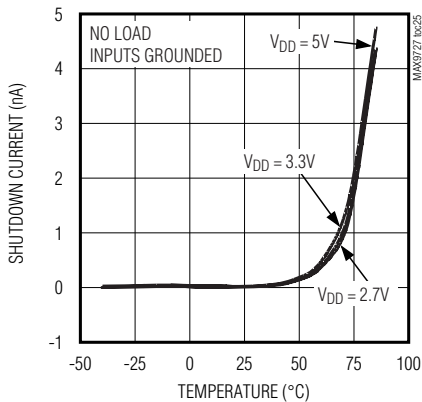

OUTPUT SPECTRUM vs. FREQUENCY

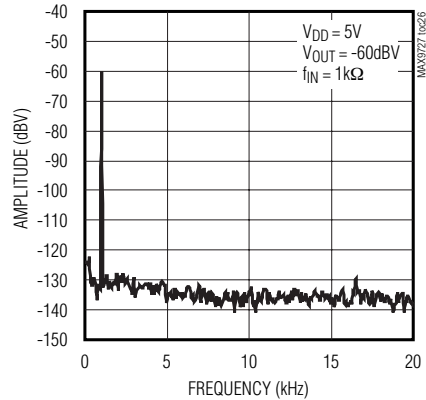

Quad Audio Line Driver with 3V_{RMS} Output

Typical Operating Characteristics (continued)

(V_{DD} = PV_{DD} = 3.3V, V_{CM} = 0V, R_{IN} = R_F = 5k Ω , THD+N measurement bandwidth = 22Hz to 22kHz, T_A = +25°C, unless otherwise noted.)

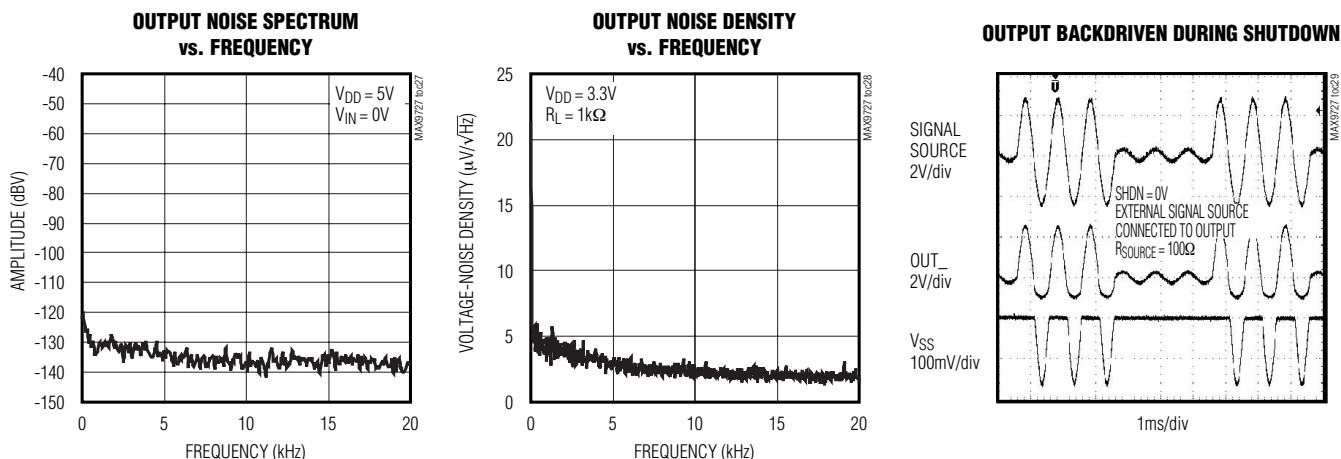

Pin Description

PIN	NAME	FUNCTION
1	OUTA	Output A
2	INA-	Inverting Input A
3	INA+	Noninverting Input A
4	V _{DD}	Analog Positive Supply. Bypass with a 0.1 μ F capacitor to PGND.
5	INB+	Noninverting Input B
6	INB-	Inverting Input B
7	OUTB	Output B
8	SHDN	Active-Low Shutdown Input. Connect SHDN to V _{DD} for normal operation.
9	PV _{DD}	Charge-Pump Positive Supply. Bypass with a 1 μ F capacitor to PGND.
10	C1P	Charge-Pump Flying Capacitor Positive Terminal. Connect a 1 μ F capacitor between C1P and C1N.
11	PGND	Power Ground
12	C1N	Charge-Pump Flying Capacitor Negative Terminal. Connect a 1 μ F capacitor between C1P and C1N.
13	PV _{SS}	Charge-Pump Negative Supply. Bypass with a 1 μ F capacitor to PGND.
14	OUTC	Output C
15	INC-	Inverting Input C
16	INC+	Noninverting Input C
17	V _{SS}	Amplifier Negative Rail. Connect to PV _{SS} .
18	IND+	Noninverting Input D
19	IND-	Inverting Input D
20	OUTD	Output D

Quad Audio Line Driver with 3V_{RMS} Output

Detailed Description

The MAX9727 is a quad audio line driver with an output of 3V_{RMS} from a single +5V supply and 2V_{RMS} from a single +3.3V supply. The device employs Maxim's DirectDrive architecture that produces a ground-referenced output from a single supply, eliminating the need for large DC-blocking capacitors. An internal charge pump creates an internal negative supply voltage. This allows the amplifier outputs of the MAX9727 to be biased at GND, almost doubling dynamic range while operating from a single supply.

An active-low shutdown input disables the amplifiers and reduces quiescent current consumption to less than 100nA.

The MAX9727 also features click-and-pop suppression circuitry that reduces audible clicks and pops during startup and shutdown.

DirectDrive

Maxim's DirectDrive architecture uses a charge pump to create an internal negative supply voltage, allowing the MAX9727 outputs to be biased about ground. This allows for a symmetrical output biased around 0V. The MAX9727's charge pump requires two small ceramic capacitors, conserving board space, reducing cost, and improving the frequency response of the amplifiers. See the Charge-Pump Output Voltage vs. Output Current graphs in the *Typical Operating Characteristics* for details of the possible capacitor sizes. There is a low DC voltage on the amplifier outputs due to amplifier offset. However, the offsets of the MAX9727 are typically 500μV, which, when combined with a 1kΩ load, results in less than 500nA of DC current flow to the line-in device.

Charge Pump

The MAX9727 features a low-noise charge pump. The 300kHz switching frequency is well beyond the audio range and does not interfere with audio signals. The switch drivers feature a controlled switching speed that minimizes noise generated by turn-on and turn-off transients. The di/dt noise caused by the parasitic bond wire and trace inductance is minimized by limiting the

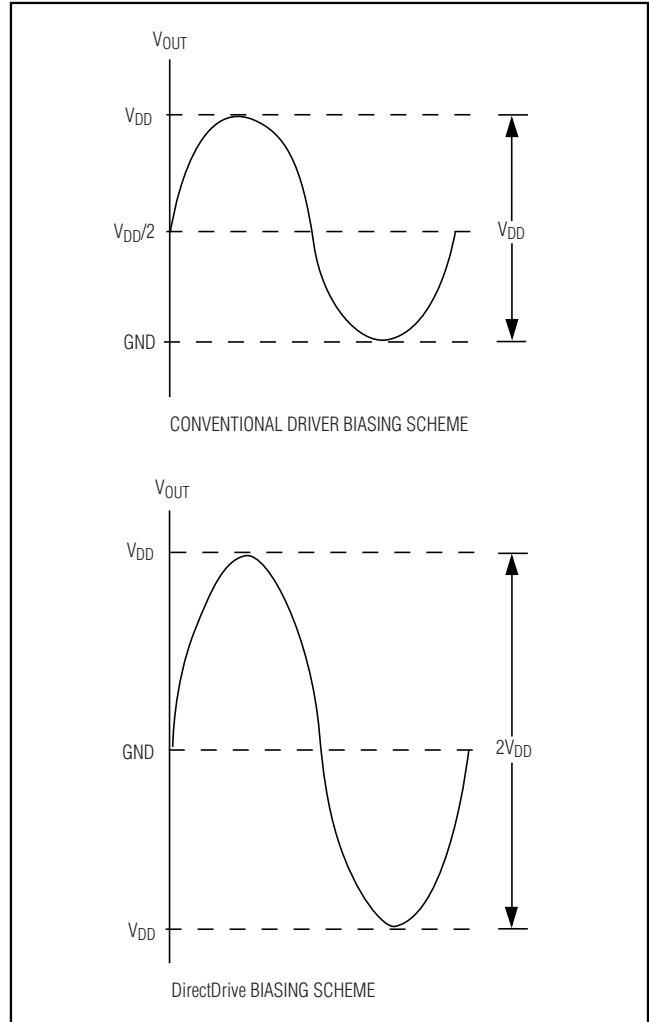

Figure 1. Conventional Driver Output Waveform vs. MAX9727 Output Waveform

switching speed of the charge pump. Although not typically required, additional high-frequency noise attenuation can be achieved by increasing the value of C2 (see the *Functional Diagram/Typical Operating Circuit*).

Quad Audio Line Driver with 3V_{RMS} Output

Shutdown Mode

The MAX9727 features a low-power shutdown mode that reduces quiescent current consumption to less than 0.1μA and extends battery life for portable applications. Drive SHDN low to disable the amplifiers and the charge pump. In shutdown mode, each amplifier's output resistance is high impedance to small signals. The resulting output resistance seen by the load is determined by the series combination of the amplifier's external gain-setting resistors in parallel with the amplifier's shutdown output resistance.

Click-and-Pop Suppression

In conventional single-supply audio amplifiers, the output-coupling capacitor contributes significantly to audible clicks and pops. Upon startup, the amplifier charges the coupling capacitor to its bias voltage, typically half the supply. Likewise, on shutdown, the capacitor is discharged. This results in a DC shift across the capacitor, which appears as an audible transient at the speaker connected to the output of the power amplifier of the audio system. Since the MAX9727 does not require output-coupling capacitors, this problem does not arise. Additionally, the MAX9727 features extensive click-and-pop suppression that eliminates any audible transient sources internal to the device.

In some applications, the output of the device driving the MAX9727 may have a DC bias. At startup, the input-coupling capacitor is charged to the input device's DC-bias voltage through the input and feedback resistors of the MAX9727, resulting in a DC shift across the capacitor and an audible click/pop. Delay the rise of SHDN 4 to 5 time constants based on R_{IN} and C_{IN} (4 × R_{IN} × C_{IN}), relative to the startup of the input device, to eliminate clicks-and-pops caused by the input filter.

Applications Information

Amplifier Configurations

The MAX9727 works in many standard op-amp configurations such as inverting, noninverting, voltage follower, summing, difference, active filters, and many others. No special design considerations are required. The DirectDrive architecture of the MAX9727 simplifies many circuits due to the ground-referenced outputs.

Differential Input Configuration

Figure 2 shows a single channel of the MAX9727 configured as a differential input amplifier. A differential input offers improved noise immunity over a single-ended input. In systems that include high-speed digital circuitry, high-frequency noise can couple into the amplifier's input traces. The signals appear at the amplifier's inputs as common-mode noise. A differential input amplifier amplifies the difference of the two inputs, and signals common to both inputs are subtracted out. When configured for differential inputs, the voltage gain of the MAX9727 is set by:

$$A_V = \frac{R_{F1}}{R_{IN1}}$$

where A_V is the desired voltage gain in V/V. R_{IN1} must be equal to R_{IN2} , and R_{F1} must be equal to R_{F2} .

The common-mode rejection ratio (CMRR) is limited by the external resistor-matching. Ideally, to achieve the highest possible CMRR the following condition should be met:

$$\frac{R_{F1}}{R_{IN1}} = \frac{R_{F2}}{R_{IN2}}$$

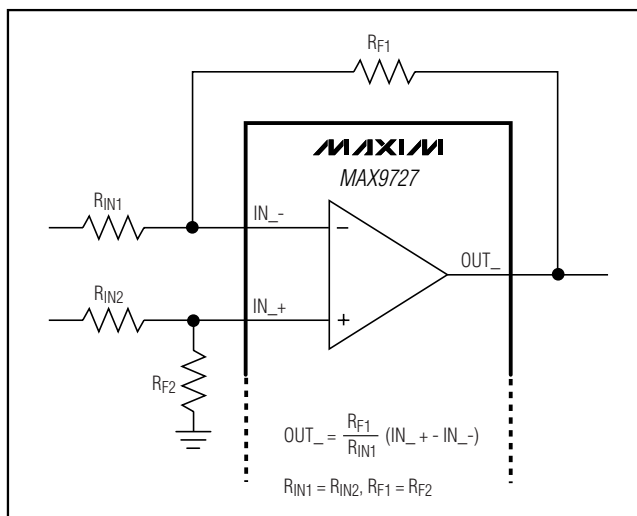

Figure 2. Differential Input Configuration

Quad Audio Line Driver with 3VRMS Output

Inverting Amplifier Configuration

Figure 3 shows a single channel of the MAX9727 configured as an inverting amplifier. External resistors R_F and R_{IN} set the voltage gain of the amplifier as follows:

$$A_V = - \frac{R_F}{R_{IN}}$$

where A_V is the desired voltage gain in V/V.

R_F can be either fixed or variable, allowing the use of a digitally controlled potentiometer to alter the gain under software control.

Active Filter Configuration

When the MAX9727 is used as a line driver to provide outputs that feed audio equipment (notebooks, desktops, receivers, and set-top boxes) with a digital-to-analog converter (DAC) used as an audio input source, it is often desirable to eliminate any high-frequency quantization noise produced by the DAC output before it reaches the load. This high-frequency noise can cause the input stages of the line-in equipment to exceed slew-rate limitations or create excessive EMI emissions on the cables between devices.

In order to suppress this noise, and to provide a 2VRMS standard audio output level from a single 5V supply, the MAX9727 can be configured as an active lowpass filter. The *Functional Diagram/Typical Application Circuit* shows the MAX9727 connected as 2-pole

Rauch/Multiple Feedback filter with a passband gain of 6dB and a -3dB (below passband) cutoff frequency of approximately 27kHz (see Figure 4 for Gain vs. Frequency plot).

Input Filter

The input capacitor C_{IN} , in conjunction with R_{IN} , forms a highpass filter that removes the DC bias from an incoming signal. The AC-coupling capacitor allows the amplifier to bias the signal to an optimum DC level. Assuming zero-source impedance, the -3dB point of the highpass filter is given by:

$$f_{-3dB} = \frac{1}{2\pi R_{IN} C_{IN}}$$

Setting f_{-3dB} too high affects the low-frequency response of the amplifier. Use capacitors with dielectrics that have low-voltage coefficients, such as tantalum or aluminum electrolytic. Capacitors with high-voltage coefficients, such as ceramics, can increase distortion at low frequencies.

Charge-Pump Capacitor Selection

Use capacitors with an ESR of less than 100mΩ for optimum performance. Low-ESR ceramic capacitors minimize the output resistance of the charge pump. For best performance over the extended temperature range, select capacitors with an X7R dielectric.

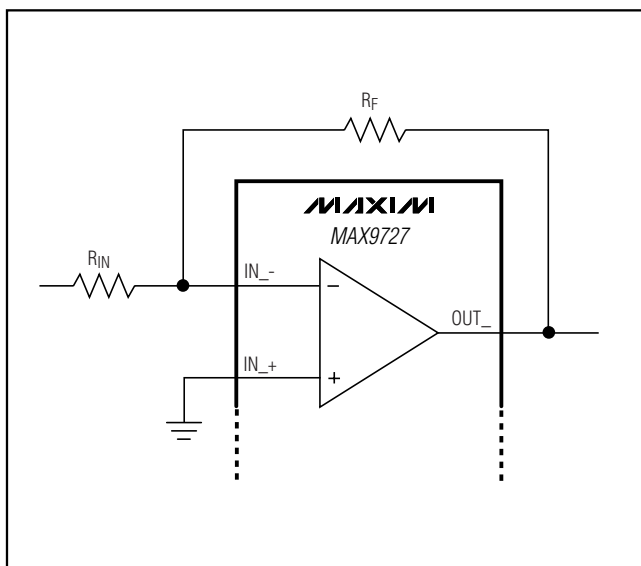

Figure 3. Inverting Amplifier Configuration

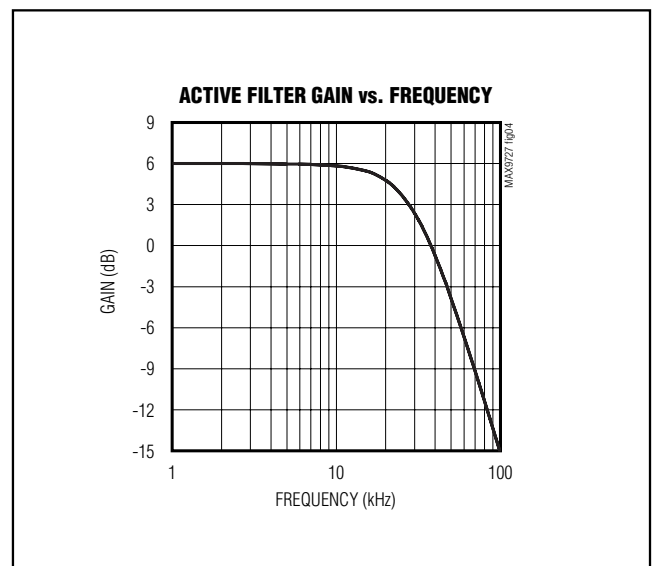

Figure 4. MAX9727 Active Filter Gain vs. Frequency

Quad Audio Line Driver with 3V_{RMS} Output

Flying Capacitor (C1)

The value of the flying capacitor (C1) affects the load regulation and the output resistance of the charge pump. A C1 value that is too small degrades the device's ability to provide sufficient current drive, which leads to a loss of output voltage. Increasing the value of C1 improves the load regulation and reduces the charge-pump output resistance to an extent. See the Charge-Pump Output Voltage vs. Output Current graphs in the *Typical Operating Characteristics*. Above 2.2 μ F, the on-resistance of the switches and the ESR of C1 and C2 dominate.

Hold Capacitor (C2)

The hold capacitor value and ESR directly affect the ripple at PV_{SS}. Increasing the value of C2 reduces the output ripple. Likewise, decreasing the ESR of C2 reduces both ripple and output resistance. Lower capacitance values can be used in systems with low maximum output voltage levels. See the Charge-Pump Output Voltage vs. Output Current graphs in the *Typical Operating Characteristics*. C2 should be greater than or equal to the value of C1.

PV_{DD} Bypass Capacitor (C3)

The PV_{DD} bypass capacitor lowers the output impedance of the power supply and reduces the impact of the MAX9727's charge-pump switching transients. Bypass PV_{DD} with C3 and place it physically close to PV_{DD} and PGND. C3 should be greater than or equal to the value of C1.

Supply Bypassing

Proper power-supply bypassing ensures low-noise, low-distortion performance. Connect a 1 μ F ceramic capacitor from V_{DD} to PGND.

Layout and Grounding

Good PC board layout is essential for optimizing performance. Use large traces for the power-supply inputs and amplifier outputs to minimize losses due to trace resistance. Good grounding improves audio performance, minimizes crosstalk between channels, and prevents any digital switching noise from coupling into the audio signal. Route PGND and all traces that carry switching transients away from traces and components in the audio signal path.

Place the charge-pump capacitors (C1 and C2) as close to the device as possible. Connect V_{SS} and PV_{SS} together at capacitor C2.

Thermal-Overload Protection

Thermal-overload protection limits the total power dissipation in the MAX9727. When the junction temperature exceeds +160°C, the thermal protection circuitry disables the amplifier output stages. The junction temperature must cool by 15°C before normal operation can continue.

Chip Information

PROCESS: BiCMOS

Quad Audio Line Driver with 3VRMS Output

Functional Diagram/Typical Operating Circuit

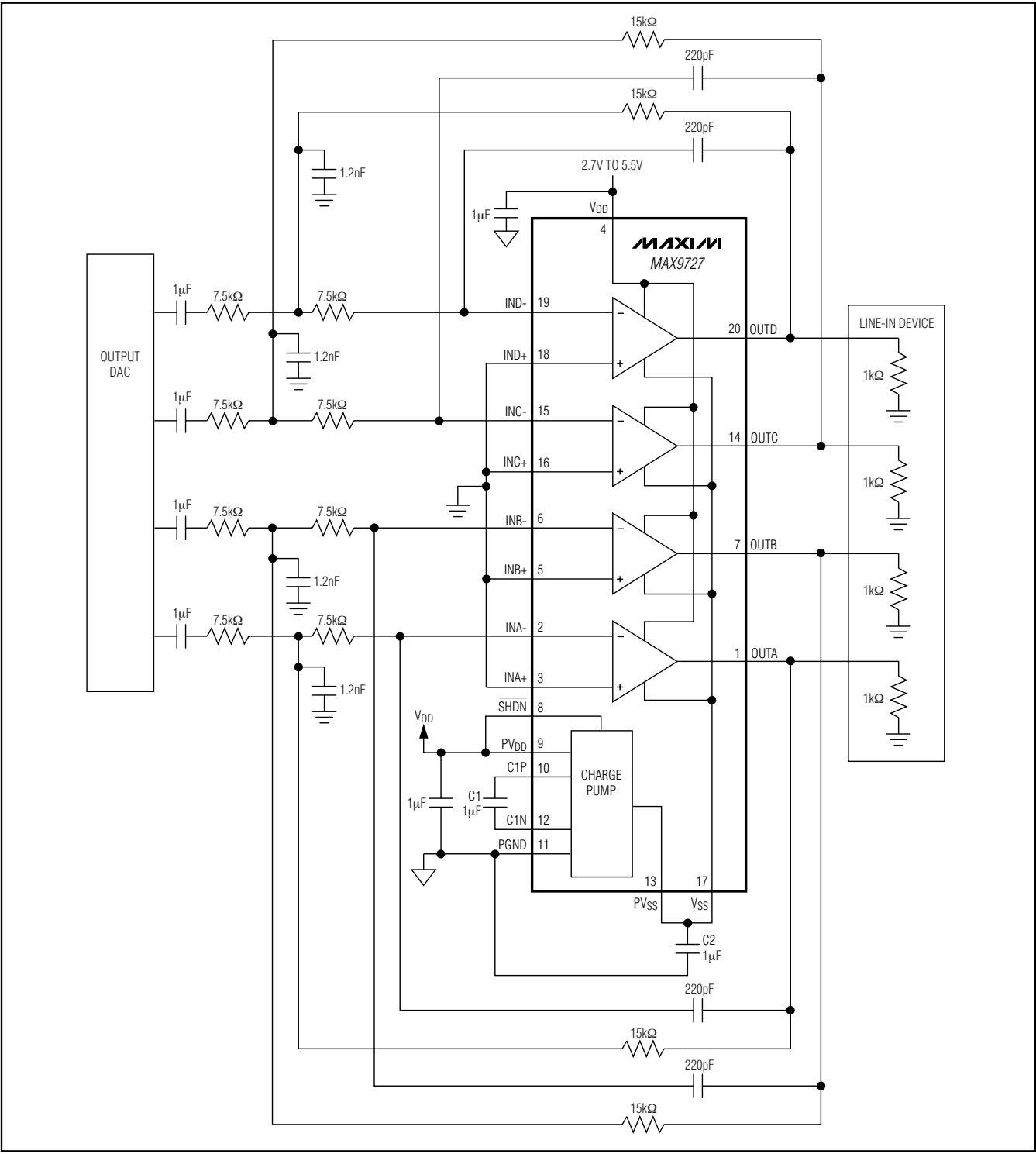

Quad Audio Line Driver with 3V_{RMS} Output

Package Information

(The package drawing(s) in this data sheet may not reflect the most current specifications. For the latest package outline information go to www.maxim-ic.com/packages.)

MAX9727

QSOP.EPS

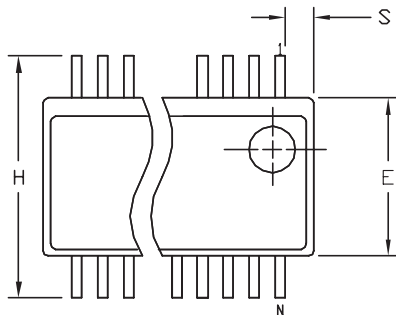

DIM	INCHES		MILLIMETERS	
	MIN	MAX	MIN	MAX
A	.053	.069	1.35	1.75
A1	.004	.010	.102	.254
A2	.049	.065	1.245	1.651
B	.008	.012	0.20	0.30
C	.0075	.0098	0.191	0.249
D	SEE VARIATIONS			
E	.150	.157	3.81	3.99
e	.025 BSC		0.635 BSC	
H	.230	.244	5.84	6.20
h	.010	.016	0.25	0.41
L	.016	.035	0.41	0.89
N	SEE VARIATIONS			
α	0°	8°	0°	8°

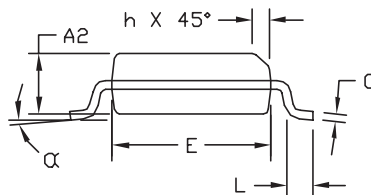
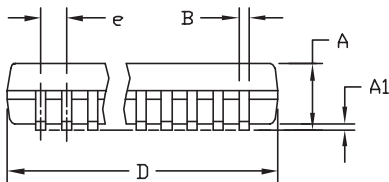

VARIATIONS:

DIM	INCHES		MILLIMETERS		N
	MIN.	MAX.	MIN.	MAX.	
D	.189	.196	4.80	4.98	16 AB
S	.0020	.0070	0.05	0.18	
D	.337	.344	8.56	8.74	20 AD
S	.0500	.0550	1.270	1.397	
D	.337	.344	8.56	8.74	24 AE
S	.0250	.0300	0.635	0.762	
D	.386	.393	9.80	9.98	28 AF
S	.0250	.0300	0.635	0.762	

NOTES:

- 1). D & E DO NOT INCLUDE MOLD FLASH OR PROTRUSIONS.
- 2). MOLD FLASH OR PROTRUSIONS NOT TO EXCEED .006" PER SIDE.
- 3). CONTROLLING DIMENSIONS: INCHES.
- 4). MEETS JEDEC MO137.



DALLAS SEMICONDUCTOR **MAXIM**
 PROPRIETARY INFORMATION
 TITLE:
 PACKAGE OUTLINE, QSOP .150", .025" LEAD PITCH
 APPROVAL: _____ DOCUMENT CONTROL NO. 21-0055 REV. F 1/1

Maxim cannot assume responsibility for use of any circuitry other than circuitry entirely embodied in a Maxim product. No circuit patent licenses are implied. Maxim reserves the right to change the circuitry and specifications without notice at any time.







Maxim Integrated Products, 120 San Gabriel Drive, Sunnyvale, CA 94086 408-737-7600 13

Looking for pricing, stock, or lifecycle information?

Click below to explore more details on WIN SOURCE:

-  [View MAX9727EEP+ on WIN SOURCE](#)
-  [Analog Devices Inc. Information](#)

Optimize Your Supply Chain with WIN SOURCE Solutions

-  Global Sourcing Solution
-  Obsolete Management
-  Cost Control Management
-  Shortage Management
-  Alternative Solution
-  Excess Inventory Management