



**THE DATASHEET OF  
DAC8565IAPW**





# 16-Bit, Quad Channel, Ultra-Low Glitch, Voltage Output Digital-to-Analog Converter with 2.5V, 2ppm/°C Internal Reference

 Check for Samples: [DAC8565](#)

## FEATURES

- **Relative Accuracy:** 4LSB
- **Glitch Energy:** 0.15nV-s
- **Internal Reference:**
  - 2.5V Reference Voltage (enabled by default)
  - 0.004% Initial Accuracy (typ)
  - 2ppm/°C Temperature Drift (typ)
  - 5ppm/°C Temperature Drift (max)
  - 20mA Sink/Source Capability
- **Power-On Reset to Zero-Scale or Midscale**
- **Asynchronous Clear to Zero-Scale or Midscale**
- **Ultra-Low Power Operation:** 1mA at 5V
- **Wide Power Supply Range:** +2.7V to +5.5V
- **16-Bit Monotonic Over Temperature Range**
- **Settling Time:** 10µs to ±0.003% Full-Scale Range (FSR)
- **Low-Power Serial Interface with Schmitt-Triggered Inputs:** Up to 50MHz
- **On-Chip Output Buffer Amplifier with Rail-to-Rail Operation**
- **1.8V to 5.5V Logic Compatibility**
- **Temperature Range:** –40°C to +105°C

## APPLICATIONS

- **Portable Instrumentation**
- **Closed-Loop Servo-Control**
- **Process Control, PLCs**
- **Data Acquisition Systems**
- **Programmable Attenuation**
- **PC Peripherals**

RELATED DEVICES	16-BIT	14-BIT	12-BIT
Pin and Functionally Compatible	<a href="#">DAC8565</a>	<a href="#">DAC8165</a>	<a href="#">DAC7565</a>
Functionally Compatible	<a href="#">DAC8564</a>	<a href="#">DAC8164</a>	<a href="#">DAC7564</a>

## DESCRIPTION

The DAC8565 is a low-power, voltage-output, four-channel, 16-bit digital-to-analog converter (DAC). The device includes a 2.5V, 2ppm/°C internal reference (enabled by default), giving a full-scale output voltage range of 2.5V. The internal reference has an initial accuracy of 0.004% and can source up to 20mA at the  $V_{REFH}/V_{REFOUT}$  pin. The device is monotonic, provides very good linearity, and minimizes undesired code-to-code transient voltages (glitch). The DAC8565 use a versatile 3-wire serial interface that operates at clock rates up to 50MHz. It is compatible with standard SPI™, QSPI™, Microwire™, and digital signal processor (DSP) interfaces.

The DAC8565 incorporates a power-on-reset circuit that ensures the DAC output powers up at either zero-scale or midscale until a valid code is written to the device. The device contains a power-down feature, accessed over the serial interface, that reduces the current consumption of the device to 1.3µA at 5V. The low power consumption, internal reference, and small footprint make this device ideal for portable, battery-operated equipment. The power consumption is 2.9mW at 3V, reducing to 1.5µW in power-down mode.

The DAC8565 is drop-in and functionally compatible with the [DAC7564](#) and [DAC8164](#), and functionally compatible with the [DAC7565](#), [DAC8165](#), and [DAC8564](#). All these devices are available in a TSSOP-16 package.

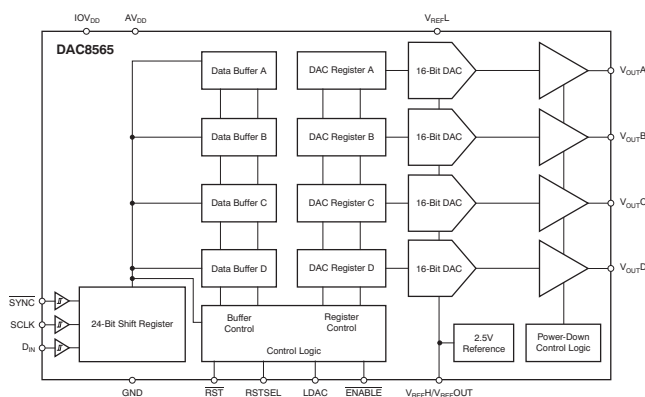

Please be aware that an important notice concerning availability, standard warranty, and use in critical applications of Texas Instruments semiconductor products and disclaimers thereto appears at the end of this data sheet.

SPI, QSPI are trademarks of Motorola, Inc.

Microwire is a trademark of National Semiconductor.

All other trademarks are the property of their respective owners.

PRODUCTION DATA information is current as of publication date. Products conform to specifications per the terms of the Texas Instruments standard warranty. Production processing does not necessarily include testing of all parameters.



This integrated circuit can be damaged by ESD. Texas Instruments recommends that all integrated circuits be handled with appropriate precautions. Failure to observe proper handling and installation procedures can cause damage.

ESD damage can range from subtle performance degradation to complete device failure. Precision integrated circuits may be more susceptible to damage because very small parametric changes could cause the device not to meet its published specifications.

### PACKAGE/ORDERING INFORMATION<sup>(1)</sup>

PRODUCT	RELATIVE ACCURACY (LSB)	DIFFERENTIAL NONLINEARITY (LSB)	REFERENCE DRIFT (ppm/°C)	PACKAGE-LEAD	PACKAGE DESIGNATOR	SPECIFIED TEMPERATURE RANGE	PACKAGE MARKING
DAC8565A	±12	±1	25	TSSOP-16	PW	–40°C to +105°C	DAC8565
DAC8565B	±8	±1	25	TSSOP-16	PW	–40°C to +105°C	DAC8565B
DAC8565C	±12	±1	5	TSSOP-16	PW	–40°C to +105°C	DAC8565
DAC8565D	±8	±1	5	TSSOP-16	PW	–40°C to +105°C	DAC8565D

(1) For the most current package and ordering information see the Package Option Addendum at the end of this document, or see the TI web site at [www.ti.com](http://www.ti.com).

### ABSOLUTE MAXIMUM RATINGS<sup>(1)</sup>

Over operating free-air temperature range (unless otherwise noted).

	DAC8565	UNIT
$V_{DD}$ to GND	–0.3 to +6	V
Digital input voltage to GND	–0.3 to $V_{DD} + 0.3$	V
$V_{OUT}$ to GND	–0.3 to $V_{DD} + 0.3$	V
$V_{REF}$ to GND	–0.3 to $V_{DD} + 0.3$	V
Operating temperature range	–40 to +125	°C
Storage temperature range	–65 to +150	°C
Junction temperature range ( $T_J$ max)	+150	°C
Power dissipation	$(T_J \text{ max} - T_A)/\theta_{JA}$	W
Thermal impedance, $\theta_{JA}$	+118	°C/W
Thermal impedance, $\theta_{JC}$	+29	°C/W
ESD rating	Human body model (HBM)	4000
	Charged device model (CDM)	1500

(1) Stresses above those listed under *Absolute Maximum Ratings* may cause permanent damage to the device. Exposure to absolute maximum conditions for extended periods may affect device reliability.

## ELECTRICAL CHARACTERISTICS

 At  $V_{DD} = 2.7V$  to  $5.5V$ ,  $-40^{\circ}C$  to  $+105^{\circ}C$  range, and data format is straight binary (unless otherwise noted).

PARAMETER	TEST CONDITIONS	DAC8565			UNIT	
		MIN	TYP	MAX		
<b>STATIC PERFORMANCE<sup>(1)</sup></b>						
Resolution		16			Bits	
Relative accuracy	Measured by the line passing through codes 485 and 64714	DAC8565A, DAC8565C		$\pm 4$	$\pm 12$	LSB
		DAC8565B, DAC8565D		$\pm 4$	$\pm 8$	LSB
Differential nonlinearity	16-bit monotonic		$\pm 0.5$	$\pm 1$	LSB	
Offset error	Measured by the line passing through codes 485 and 64714.		$\pm 5$	$\pm 8$	mV	
Offset error drift			$\pm 1$		$\mu V/^{\circ}C$	
Full-scale error			$\pm 0.2$	$\pm 0.5$	% of FSR	
Gain error			$\pm 0.05$	$\pm 0.2$	% of FSR	
Gain temperature coefficient		$AV_{DD} = 5V$		$\pm 1$		ppm of FSR/ $^{\circ}C$
	$AV_{DD} = 2.7V$		$\pm 2$			
PSRR      Power-supply rejection ratio	Output unloaded		1		mV/V	
<b>OUTPUT CHARACTERISTICS<sup>(2)</sup></b>						
Output voltage range		0		$V_{REF}$	V	
Output voltage settling time	$T_0 \pm 0.003\%$ FSR, 0200h to FD00h, $R_L = 2k\Omega$ , $0pF < C_L < 200pF$		8	10	$\mu s$	
	$R_L = 2k\Omega$ , $C_L = 500pF$		12			
Slew rate			2.2		V/ $\mu s$	
Capacitive load stability	$R_L = \infty$		470		pF	
	$R_L = 2k\Omega$		1000			
Code change glitch impulse	1LSB change around major carry		0.15		nV-s	
Digital feedthrough	SCLK toggling, $\overline{SYNC}$ high		0.15		nV-s	
Channel-to-channel dc crosstalk	Full-scale swing on adjacent channel		0.25		LSB	
Channel-to-channel ac crosstalk	1kHz full-scale sine wave, outputs unloaded		-100		dB	
DC output impedance	At mid-code input		1		$\Omega$	
Short-circuit current			50		mA	
Power-up time	Coming out of power-down mode, $AV_{DD} = 5V$		2.5		$\mu s$	
	Coming out of power-down mode, $AV_{DD} = 3V$		5			
<b>AC PERFORMANCE<sup>(2)</sup></b>						
SNR	$T_A = +25^{\circ}C$ , BW = 20kHz, $V_{DD} = 5V$ , $f_{OUT} = 1kHz$ . First 19 harmonics removed for SNR calculation.		90		dB	
THD			-77		dB	
SFDR			78		dB	
SINAD			77		dB	
DAC output noise density	$T_A = +25^{\circ}C$ , at mid-code input, $f_{OUT} = 1kHz$		120		$nV/\sqrt{Hz}$	
DAC output noise	$T_A = +25^{\circ}C$ , at mid-code input, 0.1Hz to 10Hz		6		$\mu V_{PP}$	
<b>REFERENCE</b>						
Internal reference current consumption	$AV_{DD} = 5.5V$		360		$\mu A$	
	$AV_{DD} = 3.6V$		348		$\mu A$	
External reference current	External $V_{REF} = 2.5V$ , if internal reference is disabled, all four channels active		80		$\mu A$	
Reference input range $V_{REFH}$ Voltage	$V_{REFL} < V_{REFH}$ , $AV_{DD} - (V_{REFH} + V_{REFL}) / 2 > 1.2V$	0		$AV_{DD}$	V	
Reference input range $V_{REFL}$ Voltage	$V_{REFL} < V_{REFH}$ , $AV_{DD} - (V_{REFH} + V_{REFL}) / 2 > 1.2V$	0		$AV_{DD}/2$	V	
Reference input impedance			31		k $\Omega$	

(1) Linearity calculated using a reduced code range of 485 to 64714; output unloaded.

(2) Ensured by design or characterization; not production tested.

## ELECTRICAL CHARACTERISTICS (continued)

At  $V_{DD} = 2.7V$  to  $5.5V$ ,  $-40^{\circ}C$  to  $+105^{\circ}C$  range, and data format is straight binary (unless otherwise noted).

PARAMETER	TEST CONDITIONS	DAC8565			UNIT
		MIN	TYP	MAX	
<b>REFERENCE OUTPUT</b>					
Output voltage	$T_A = +25^{\circ}C$	2.4975	2.5	2.5025	V
Initial accuracy	$T_A = +25^{\circ}C$	-0.1	$\pm 0.004$	0.1	%
Output voltage temperature drift	DAC8565A, DAC8565B <sup>(3)</sup>		5	25	ppm/ $^{\circ}C$
	DAC8565C, DAC8565D <sup>(4)</sup>		2	5	
Output voltage noise	$f = 0.1Hz$ to $10Hz$		12		$\mu V_{PP}$
Output voltage noise density (high-frequency noise)	$T_A = +25^{\circ}C$ , $f = 1MHz$ , $C_L = 0\mu F$		50		$nV/\sqrt{Hz}$
	$T_A = +25^{\circ}C$ , $f = 1MHz$ , $C_L = 1\mu F$		20		
	$T_A = +25^{\circ}C$ , $f = 1MHz$ , $C_L = 4\mu F$		16		
Load regulation, sourcing <sup>(5)</sup>	$T_A = +25^{\circ}C$		30		$\mu V/mA$
Load regulation, sinking <sup>(5)</sup>	$T_A = +25^{\circ}C$		15		$\mu V/mA$
Output current load capability <sup>(6)</sup>			$\pm 20$		mA
Line regulation	$T_A = +25^{\circ}C$		10		$\mu V/V$
Long-term stability/drift (aging) <sup>(5)</sup>	$T_A = +25^{\circ}C$ , time = 0 to 1900 hours		50		ppm
Thermal hysteresis <sup>(5)</sup>	First cycle		100		ppm
	Additional cycles		25		
<b>LOGIC INPUTS<sup>(6)</sup></b>					
Input current			$\pm 1$		$\mu A$
$V_{INL}$ Logic input LOW voltage	$2.7V \leq IOV_{DD} \leq 5.5V$		$0.3 \times IOV_{DD}$		V
	$1.8V \leq IOV_{DD} \leq 2.7V$		$0.1 \times IOV_{DD}$		
$V_{INH}$ Logic input HIGH voltage	$2.7V \leq IOV_{DD} \leq 5.5V$		$0.7 \times IOV_{DD}$		V
	$1.8V \leq IOV_{DD} \leq 2.7V$		$0.95 \times IOV_{DD}$		
Pin capacitance				3	pF
<b>POWER REQUIREMENTS</b>					
$AV_{DD}$		2.7		5.5	V
$IOV_{DD}$		1.8		5.5	V
$IO_{DD}$ <sup>(6)</sup>			10	20	$\mu A$
$I_{DD}$ <sup>(7)</sup>	Normal mode	$AV_{DD} = IOV_{DD} = 3.6V$ to $5.5V$ $V_{INH} = IOV_{DD}$ and $V_{INL} = GND$	1	1.6	mA
		$AV_{DD} = IOV_{DD} = 2.7V$ to $3.6V$ $V_{INH} = IOV_{DD}$ and $V_{INL} = GND$	0.95	1.5	
	All power-down modes	$AV_{DD} = IOV_{DD} = 3.6V$ to $5.5V$ $V_{INH} = IOV_{DD}$ and $V_{INL} = GND$	1.3	3.5	$\mu A$
		$AV_{DD} = IOV_{DD} = 2.7V$ to $3.6V$ $V_{INH} = IOV_{DD}$ and $V_{INL} = GND$	0.5	2.5	
Power Dissipation <sup>(7)</sup>	Normal mode	$AV_{DD} = IOV_{DD} = 3.6V$ to $5.5V$ $V_{INH} = IOV_{DD}$ and $V_{INL} = GND$	3.6	8.8	mW
		$AV_{DD} = IOV_{DD} = 2.7V$ to $3.6V$ $V_{INH} = IOV_{DD}$ and $V_{INL} = GND$	2.6	5.4	
	All power-down modes	$AV_{DD} = IOV_{DD} = 3.6V$ to $5.5V$ $V_{INH} = IOV_{DD}$ and $V_{INL} = GND$	4.7	19	$\mu W$
		$AV_{DD} = IOV_{DD} = 2.7V$ to $3.6V$ $V_{INH} = IOV_{DD}$ and $V_{INL} = GND$	1.4	9	
<b>TEMPERATURE RANGE</b>					
Specified performance		-40		+105	$^{\circ}C$

(3) Reference is trimmed and tested at room temperature, and is characterized from  $-40^{\circ}C$  to  $+120^{\circ}C$ .

(4) Reference is trimmed and tested at two temperatures ( $+25^{\circ}C$  and  $+105^{\circ}C$ ), and is characterized from  $-40^{\circ}C$  to  $+120^{\circ}C$ .

(5) Explained in more detail in the [Application Information](#) section of this data sheet.

(6) Ensured by design or characterization; not production tested.

(7) Input code = 32768, reference current included, no load.

## PIN CONFIGURATIONS

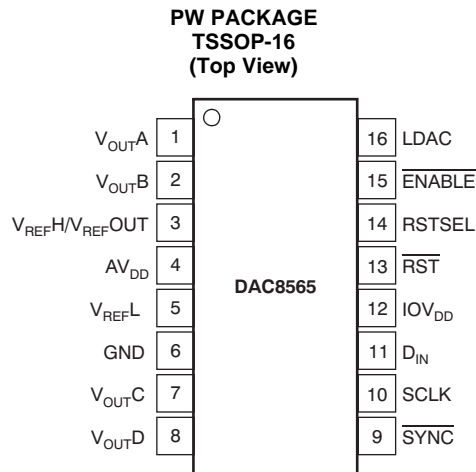

## PIN DESCRIPTIONS

PIN	NAME	DESCRIPTION
1	V <sub>OUTA</sub>	Analog output voltage from DAC A
2	V <sub>OUTB</sub>	Analog output voltage from DAC B
3	V <sub>REFH</sub> / V <sub>REFOUT</sub>	Positive reference input / reference output 2.5V if internal reference used.
4	AV <sub>DD</sub>	Power-supply input, 2.7V to 5.5V
5	V <sub>REFL</sub>	Negative reference input
6	GND	Ground reference point for all circuitry on the part
7	V <sub>OUTC</sub>	Analog output voltage from DAC C
8	V <sub>OUTD</sub>	Analog output voltage from DAC D
9	$\overline{\text{SYNC}}$	Level-triggered control input (active low). This input is the frame synchronization signal for the input data. When $\overline{\text{SYNC}}$ goes low, it enables the input shift register, and data are sampled on subsequent falling clock edges. The DAC output updates following the 24th clock. If $\overline{\text{SYNC}}$ is taken high before the 24th clock edge, the rising edge of $\overline{\text{SYNC}}$ acts as an interrupt, and the write sequence is ignored by the DAC8565. Schmitt-Trigger logic Input.
10	SCLK	Serial clock input. Data can be transferred at rates up to 50MHz. Schmitt-Trigger logic Input.
11	D <sub>IN</sub>	Serial data input. Data are clocked into the 24-bit input shift register on each falling edge of the serial clock input. Schmitt-Trigger logic Input.
12	IOV <sub>DD</sub>	Digital input-output power supply
13	$\overline{\text{RST}}$	Asynchronous reset. Active low. If $\overline{\text{RST}}$ is low, all DAC channels reset either to zero-scale (RSTSEL = 0) or to midscale (RSTSEL = 1).
14	RSTSEL	Reset select. If RSTSEL is low, input coding is binary; if high = two's complement.
15	$\overline{\text{ENABLE}}$	The enable pin (active low) connects the SPI interface to the serial port
16	LDAC	Load DACs; rising edge triggered, loads all DAC registers

**SERIAL WRITE OPERATION**

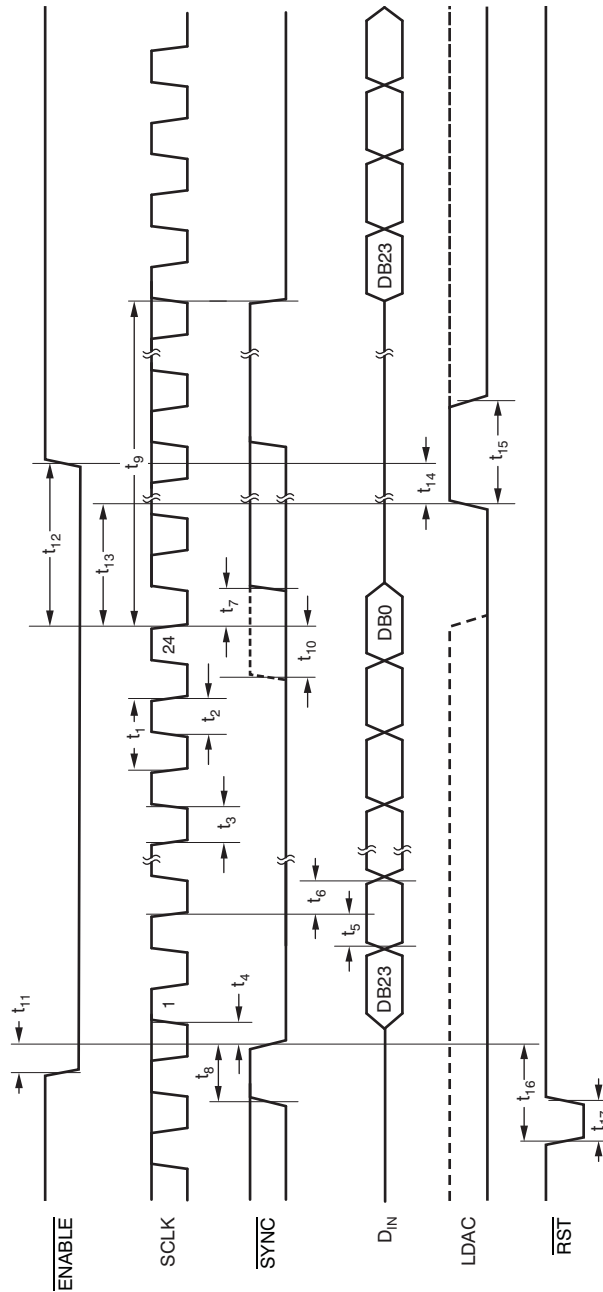

**TIMING REQUIREMENTS<sup>(1) (2)</sup>**

 At  $AV_{DD} = IOV_{DD} = 2.7V$  to  $5.5V$  and  $-40^{\circ}C$  to  $+105^{\circ}C$  range (unless otherwise noted).

PARAMETER	TEST CONDITIONS	DAC8565			UNIT
		MIN	TYP	MAX	
t <sub>1</sub> <sup>(3)</sup> SCLK cycle time	IOV <sub>DD</sub> = AV <sub>DD</sub> = 2.7V to 3.6V	40			ns
	IOV <sub>DD</sub> = AV <sub>DD</sub> = 3.6V to 5.5V	20			
t <sub>2</sub> SCLK HIGH time	IOV <sub>DD</sub> = AV <sub>DD</sub> = 2.7V to 3.6V	20			ns
	IOV <sub>DD</sub> = AV <sub>DD</sub> = 3.6V to 5.5V	10			
t <sub>3</sub> SCLK LOW time	IOV <sub>DD</sub> = AV <sub>DD</sub> = 2.7V to 3.6V	20			ns
	IOV <sub>DD</sub> = AV <sub>DD</sub> = 3.6V to 5.5V	10			
t <sub>4</sub> $\overline{SYNC}$ to SCLK rising edge setup time	IOV <sub>DD</sub> = AV <sub>DD</sub> = 2.7V to 3.6V	0			ns
	IOV <sub>DD</sub> = AV <sub>DD</sub> = 3.6V to 5.5V	0			
t <sub>5</sub> Data setup time	IOV <sub>DD</sub> = AV <sub>DD</sub> = 2.7V to 3.6V	5			ns
	IOV <sub>DD</sub> = AV <sub>DD</sub> = 3.6V to 5.5V	5			
t <sub>6</sub> Data hold time	IOV <sub>DD</sub> = AV <sub>DD</sub> = 2.7V to 3.6V	4.5			ns
	IOV <sub>DD</sub> = AV <sub>DD</sub> = 3.6V to 5.5V	4.5			
t <sub>7</sub> SCLK falling edge to $\overline{SYNC}$ rising edge	IOV <sub>DD</sub> = AV <sub>DD</sub> = 2.7V to 3.6V	0			ns
	IOV <sub>DD</sub> = AV <sub>DD</sub> = 3.6V to 5.5V	0			
t <sub>8</sub> Minimum $\overline{SYNC}$ HIGH time	IOV <sub>DD</sub> = AV <sub>DD</sub> = 2.7V to 3.6V	40			ns
	IOV <sub>DD</sub> = AV <sub>DD</sub> = 3.6V to 5.5V	20			
t <sub>9</sub> 24th SCLK falling edge to $\overline{SYNC}$ falling edge	IOV <sub>DD</sub> = AV <sub>DD</sub> = 2.7V to 3.6V	130			ns
	IOV <sub>DD</sub> = AV <sub>DD</sub> = 3.6V to 5.5V	130			
t <sub>10</sub> $\overline{SYNC}$ rising edge to 24th SCLK falling edge (for successful $\overline{SYNC}$ interrupt)	IOV <sub>DD</sub> = AV <sub>DD</sub> = 2.7V to 3.6V	15			ns
	IOV <sub>DD</sub> = AV <sub>DD</sub> = 3.6V to 5.5V	15			
t <sub>11</sub> $\overline{ENABLE}$ falling edge to $\overline{SYNC}$ falling edge	IOV <sub>DD</sub> = AV <sub>DD</sub> = 2.7V to 3.6V	15			ns
	IOV <sub>DD</sub> = AV <sub>DD</sub> = 3.6V to 5.5V	15			
t <sub>12</sub> 24th SCLK falling edge to $\overline{ENABLE}$ rising edge	IOV <sub>DD</sub> = AV <sub>DD</sub> = 2.7V to 3.6V	10			ns
	IOV <sub>DD</sub> = AV <sub>DD</sub> = 3.6V to 5.5V	10			
t <sub>13</sub> 24th SCLK falling edge to LDAC rising edge	IOV <sub>DD</sub> = AV <sub>DD</sub> = 2.7V to 3.6V	50			ns
	IOV <sub>DD</sub> = AV <sub>DD</sub> = 3.6V to 5.5V	50			
t <sub>14</sub> LDAC rising edge to $\overline{ENABLE}$ rising edge	IOV <sub>DD</sub> = AV <sub>DD</sub> = 2.7V to 3.6V	10			ns
	IOV <sub>DD</sub> = AV <sub>DD</sub> = 3.6V to 5.5V	10			
t <sub>15</sub> LDAC HIGH time	IOV <sub>DD</sub> = AV <sub>DD</sub> = 2.7V to 3.6V	10			ns
	IOV <sub>DD</sub> = AV <sub>DD</sub> = 3.6V to 5.5V	10			
t <sub>16</sub> $\overline{RST}$ rising edge to $\overline{SYNC}$ falling edge	IOV <sub>DD</sub> = AV <sub>DD</sub> = 2.7V to 3.6V	35			ns
	IOV <sub>DD</sub> = AV <sub>DD</sub> = 3.6V to 5.5V	35			
t <sub>17</sub> $\overline{RST}$ HIGH time	IOV <sub>DD</sub> = AV <sub>DD</sub> = 2.7V to 3.6V	10			ns
	IOV <sub>DD</sub> = AV <sub>DD</sub> = 3.6V to 5.5V	10			

 (1) All input signals are specified with  $t_R = t_F = 3ns$  (10% to 90% of  $V_{DD}$ ) and timed from a voltage level of  $(V_{IL} + V_{IH})/2$ .

 (2) See the [Serial Write Operation](#) timing diagram.

 (3) Maximum SCLK frequency is 50MHz at  $IOV_{DD} = V_{DD} = 3.6V$  to  $5.5V$  and 25MHz at  $IOV_{DD} = AV_{DD} = 2.7V$  to  $3.6V$ .

### TYPICAL CHARACTERISTICS: Internal Reference

At  $T_A = +25^\circ\text{C}$ , unless otherwise noted.



Figure 1.



Figure 2.



Figure 3.



Figure 4.



Figure 5.

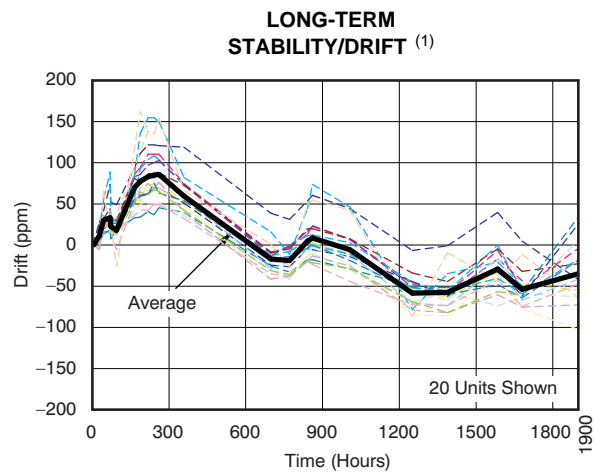

Figure 6.

(1) Explained in more detail in the [Application Information](#) section of this data sheet.

**TYPICAL CHARACTERISTICS: Internal Reference (continued)**

At  $T_A = +25^\circ\text{C}$ , unless otherwise noted.

**INTERNAL REFERENCE NOISE DENSITY  
vs  
FREQUENCY**



Figure 7.

**INTERNAL REFERENCE NOISE  
0.1Hz TO 10Hz**

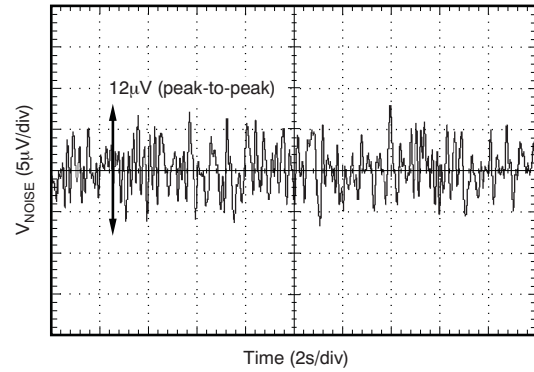

Figure 8.

**INTERNAL REFERENCE VOLTAGE  
vs  
LOAD CURRENT (Grades C and D)**

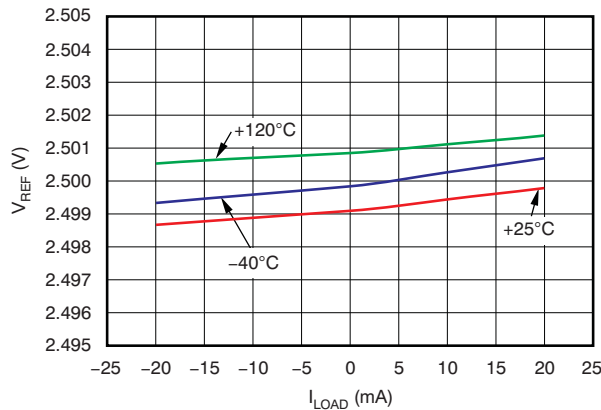

Figure 9.

**INTERNAL REFERENCE VOLTAGE  
vs  
LOAD CURRENT (Grades A and B)**

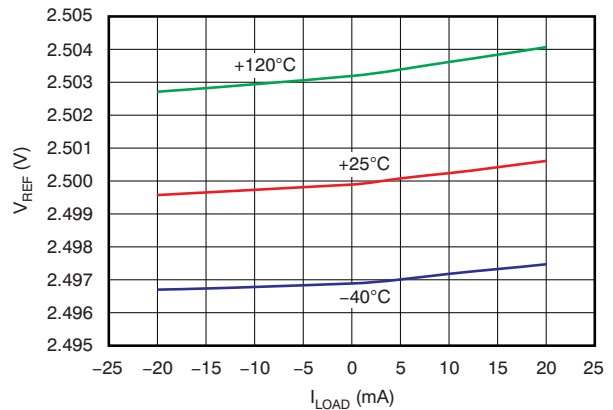

Figure 10.

**INTERNAL REFERENCE VOLTAGE  
vs  
SUPPLY VOLTAGE (Grades C and D)**

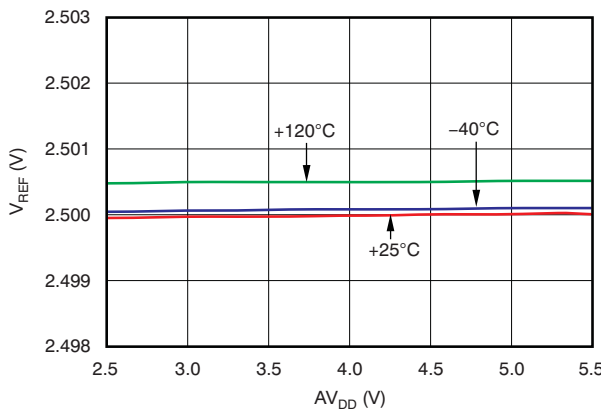

Figure 11.

**INTERNAL REFERENCE VOLTAGE  
vs  
SUPPLY VOLTAGE (Grades A and B)**

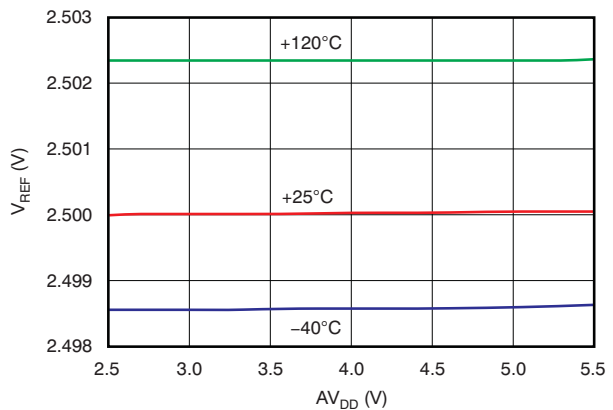

Figure 12.

**TYPICAL CHARACTERISTICS: DAC at  $V_{DD} = 5V$**

At  $T_A = +25^\circ C$ , external reference used, DAC output not loaded, and all DAC codes in straight binary data format, unless otherwise noted.

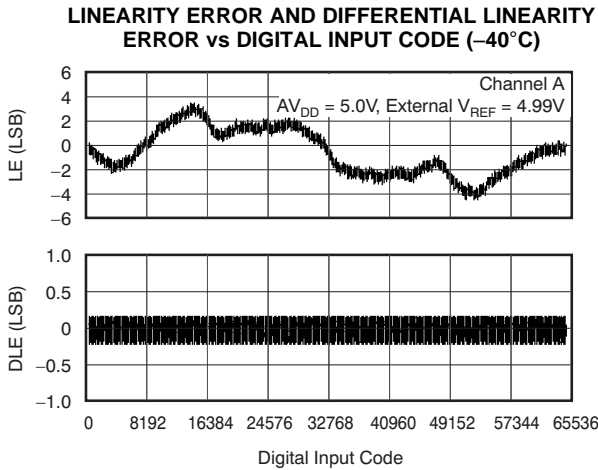

Figure 13.

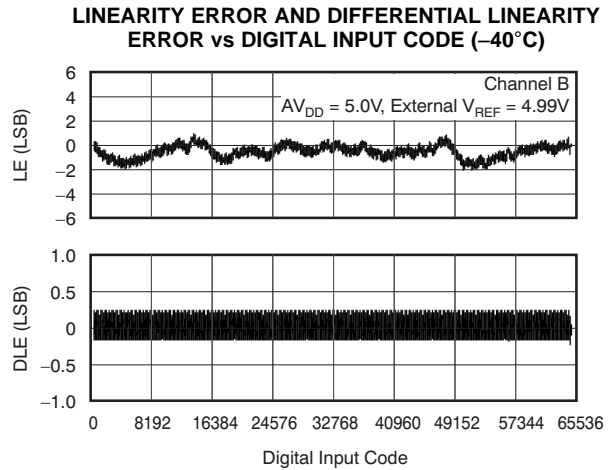

Figure 14.

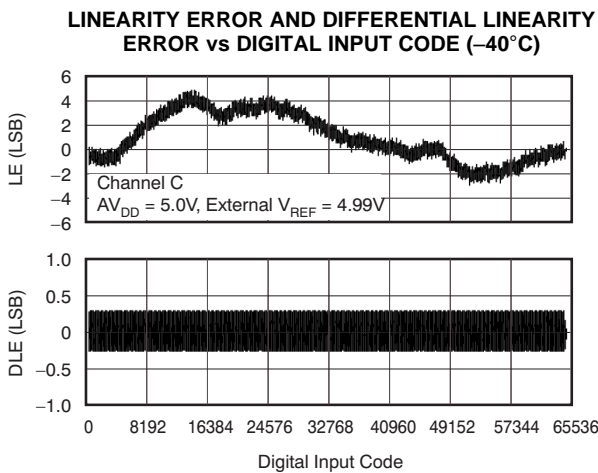

Figure 15.

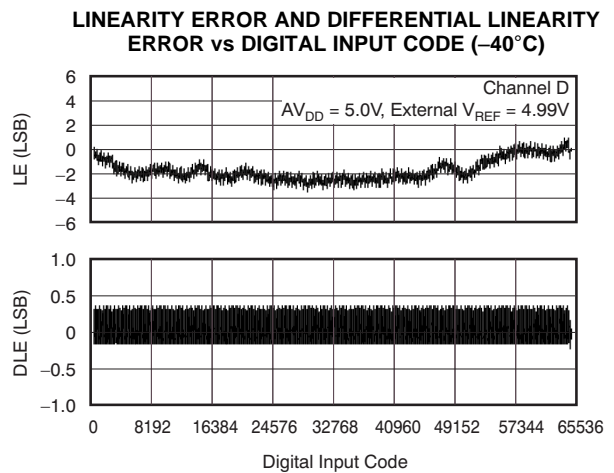

Figure 16.

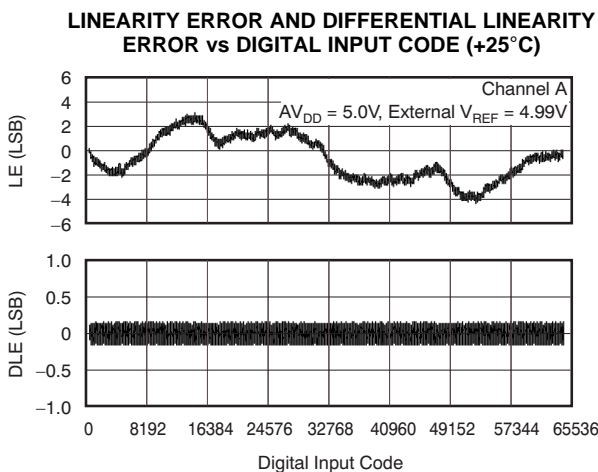

Figure 17.

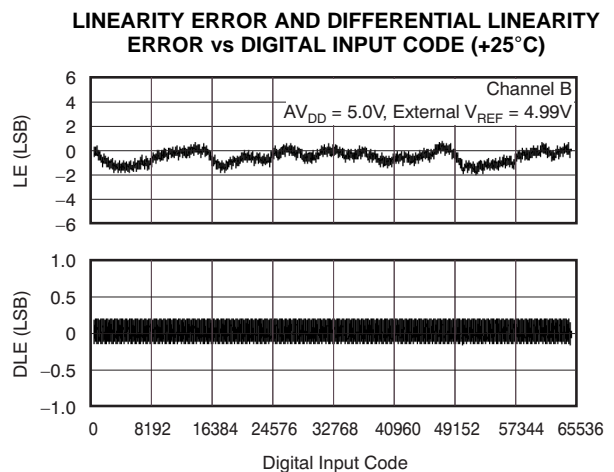
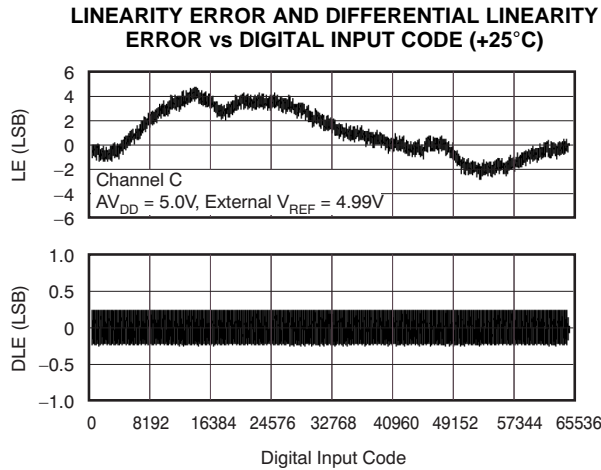

Figure 18.

**TYPICAL CHARACTERISTICS: DAC at  $V_{DD} = 5V$  (continued)**

At  $T_A = +25^\circ C$ , external reference used, DAC output not loaded, and all DAC codes in straight binary data format, unless otherwise noted.



**Figure 19.**

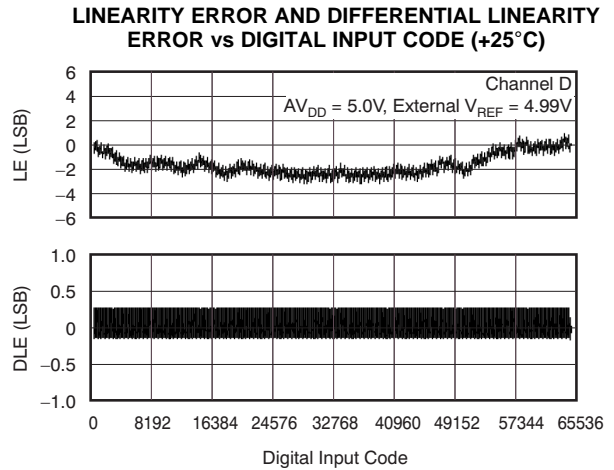

**Figure 20.**

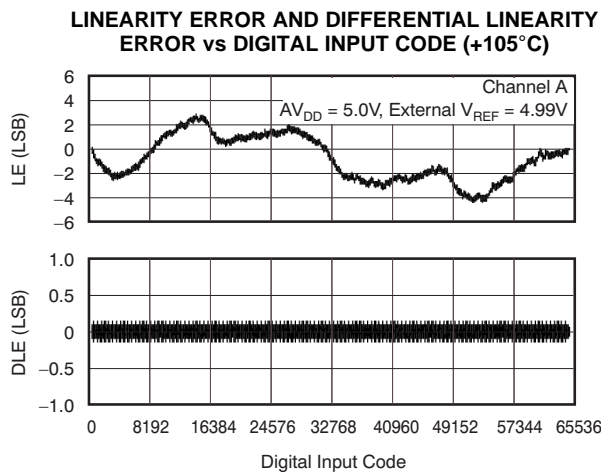

**Figure 21.**

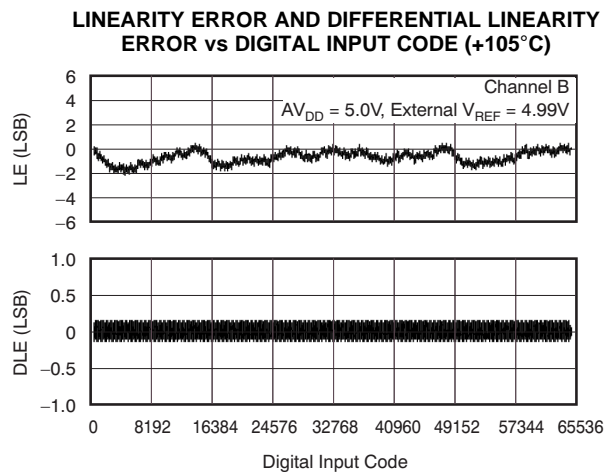

**Figure 22.**

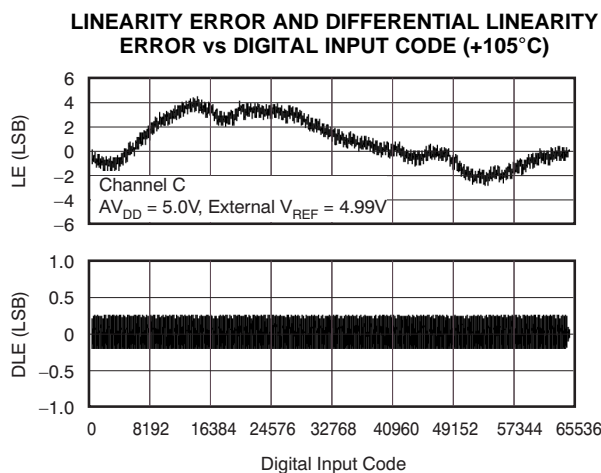

**Figure 23.**

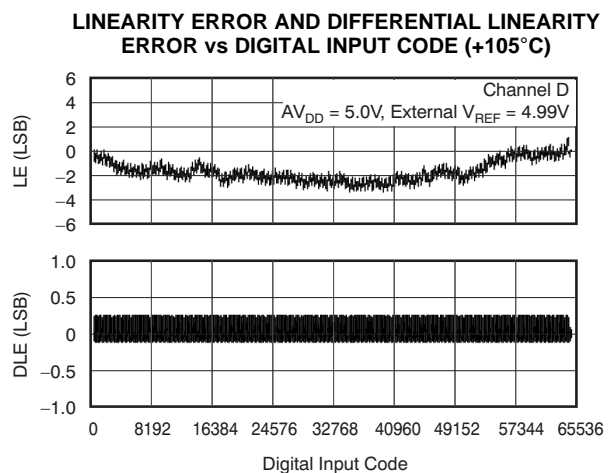

**Figure 24.**

**TYPICAL CHARACTERISTICS: DAC at AV<sub>DD</sub> = 5V (continued)**

At T<sub>A</sub> = +25°C, external reference used, DAC output not loaded, and all DAC codes in straight binary data format, unless otherwise noted.

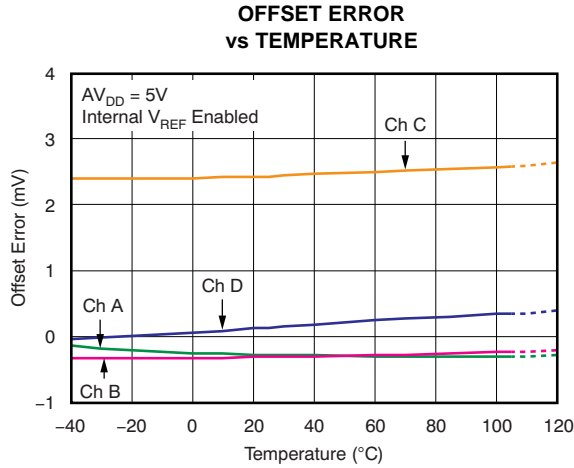

Figure 25.

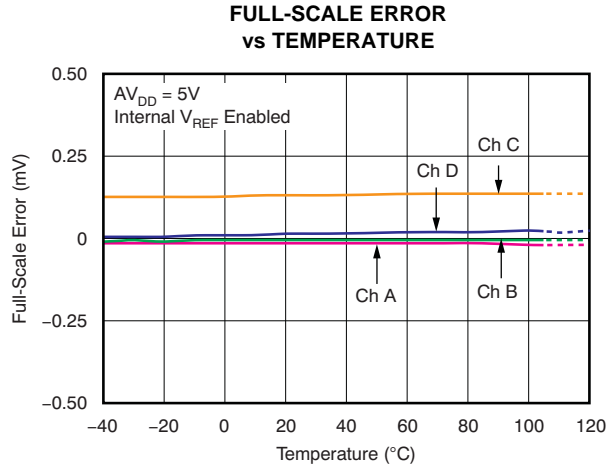

Figure 26.

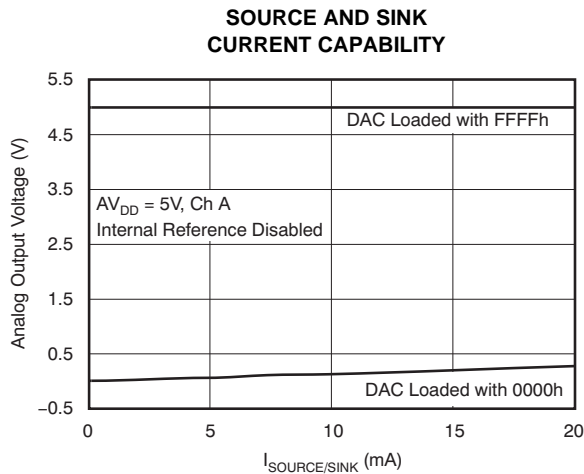

Figure 27.

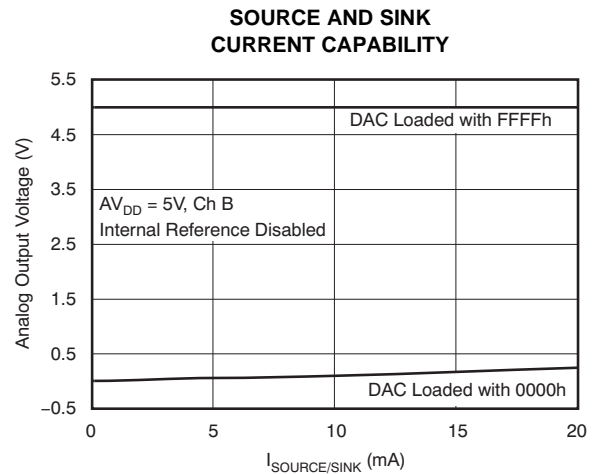

Figure 28.

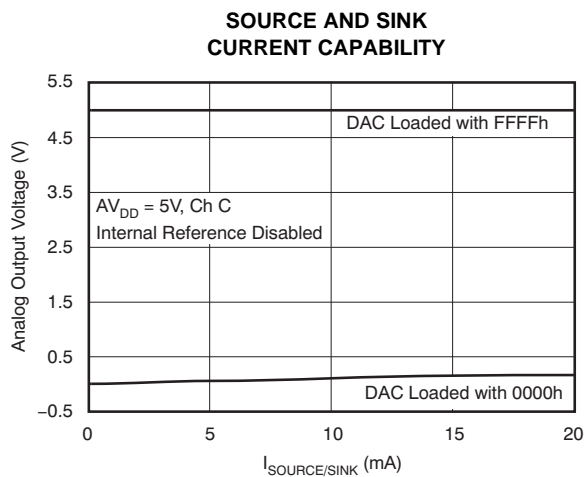

Figure 29.

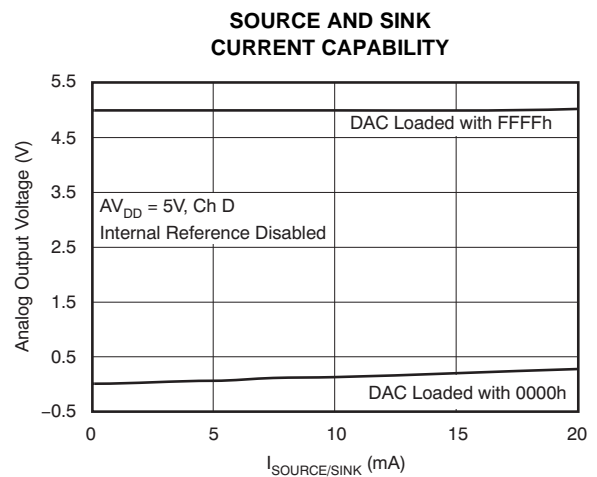
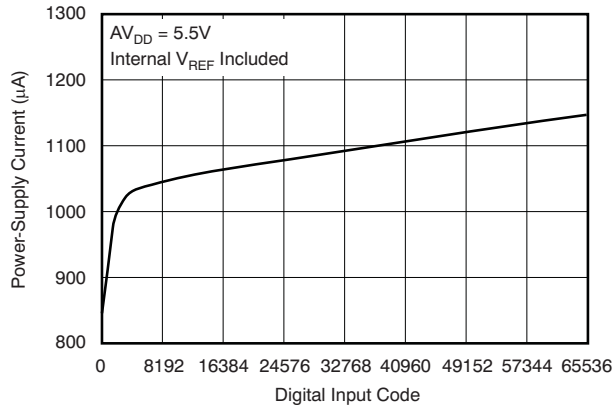

Figure 30.

**TYPICAL CHARACTERISTICS: DAC at AV<sub>DD</sub> = 5V (continued)**

At T<sub>A</sub> = +25°C, external reference used, DAC output not loaded, and all DAC codes in straight binary data format, unless otherwise noted.

**POWER-SUPPLY CURRENT vs DIGITAL INPUT CODE**



**Figure 31.**

**POWER-SUPPLY CURRENT vs TEMPERATURE**

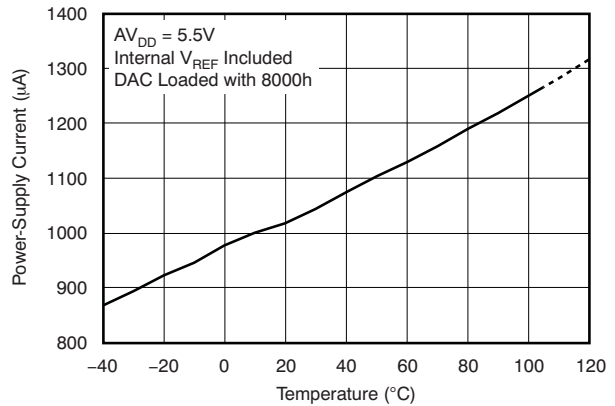

**Figure 32.**

**POWER-SUPPLY CURRENT vs POWER-SUPPLY VOLTAGE**

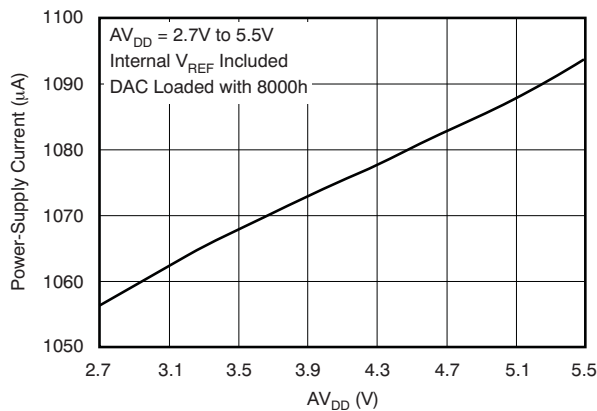

**Figure 33.**

**POWER-DOWN CURRENT vs POWER-SUPPLY VOLTAGE**

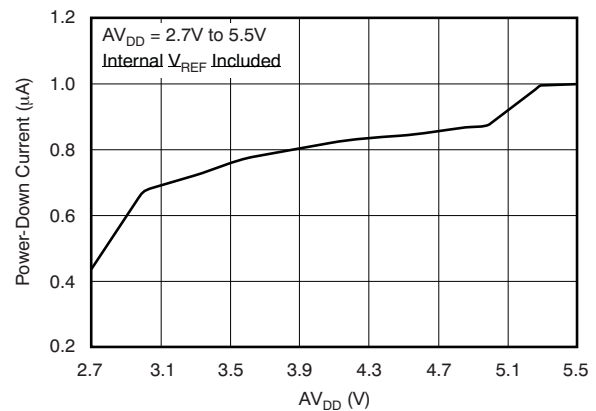

**Figure 34.**

**POWER-DOWN CURRENT vs TEMPERATURE**

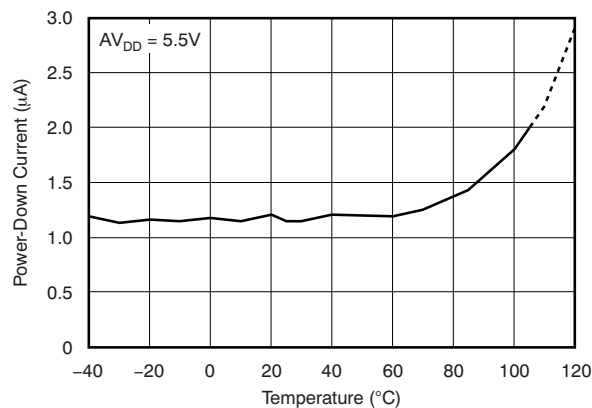

**Figure 35.**

**POWER-SUPPLY CURRENT vs LOGIC INPUT VOLTAGE**

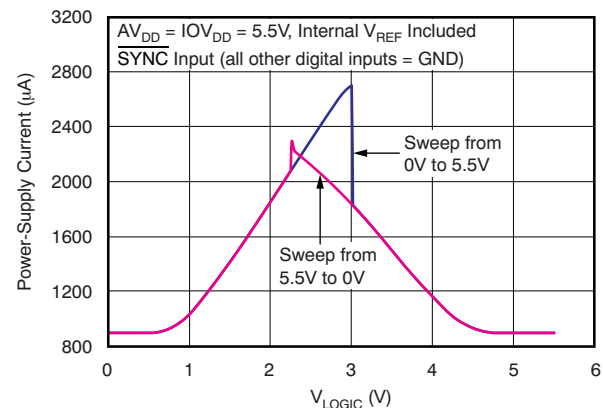
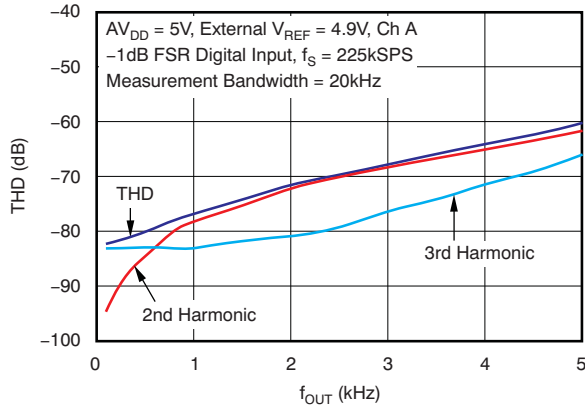

**Figure 36.**

**TYPICAL CHARACTERISTICS: DAC at  $V_{DD} = 5V$  (continued)**

At  $T_A = +25^\circ C$ , external reference used, DAC output not loaded, and all DAC codes in straight binary data format, unless otherwise noted.

**TOTAL HARMONIC DISTORTION vs OUTPUT FREQUENCY**



**Figure 37.**

**TOTAL HARMONIC DISTORTION vs OUTPUT FREQUENCY**

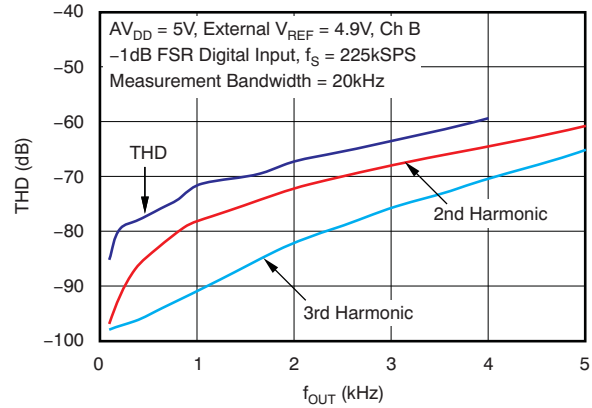

**Figure 38.**

**TOTAL HARMONIC DISTORTION vs OUTPUT FREQUENCY**

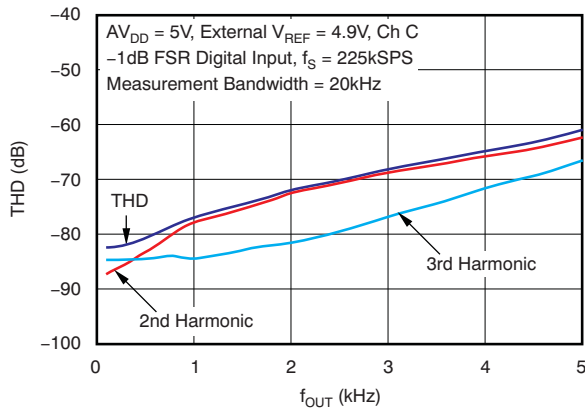

**Figure 39.**

**TOTAL HARMONIC DISTORTION vs OUTPUT FREQUENCY**

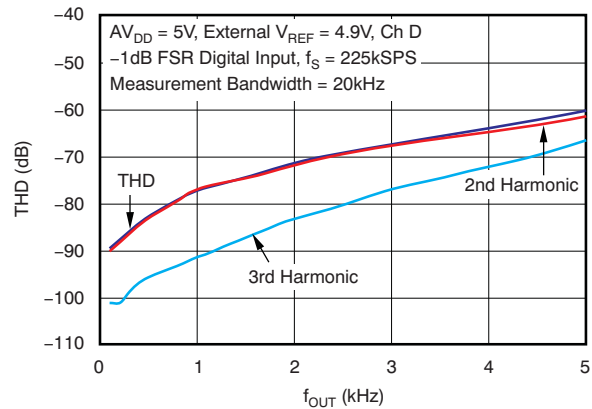

**Figure 40.**

**POWER-SUPPLY CURRENT HISTOGRAM**

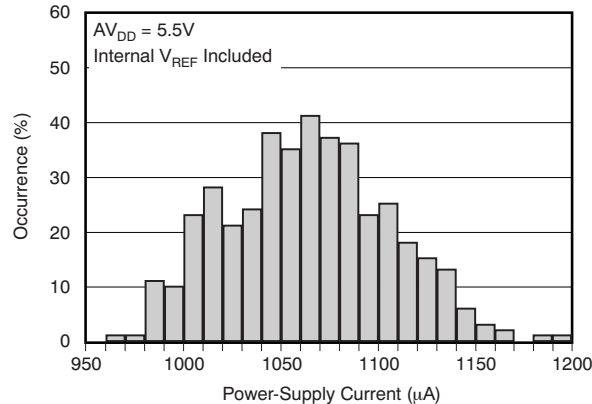

**Figure 41.**

**TYPICAL CHARACTERISTICS: DAC at AV<sub>DD</sub> = 5V (continued)**

At T<sub>A</sub> = +25°C, external reference used, DAC output not loaded, and all DAC codes in straight binary data format, unless otherwise noted.

**SIGNAL-TO-NOISE RATIO vs OUTPUT FREQUENCY**

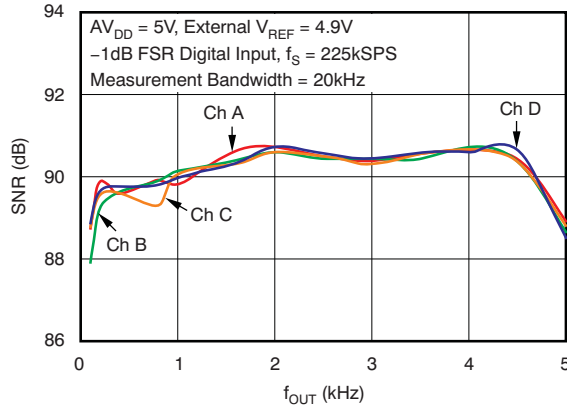

Figure 42.

**POWER SPECTRAL DENSITY**

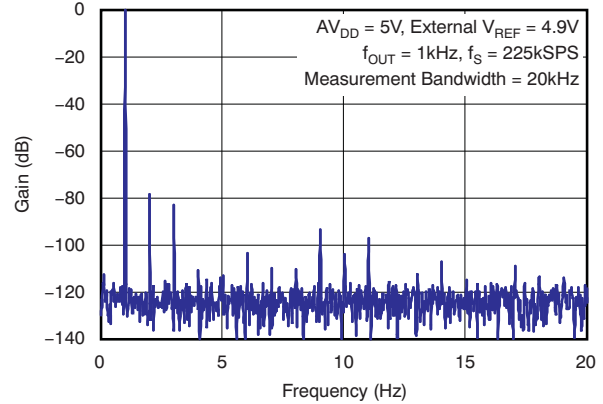

Figure 43.

**FULL-SCALE SETTLING TIME: 5V RISING EDGE**

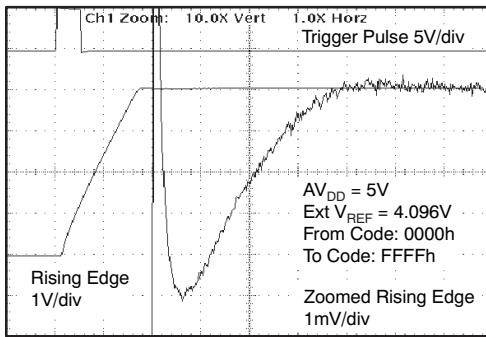

Figure 44.

**FULL-SCALE SETTLING TIME: 5V FALLING EDGE**

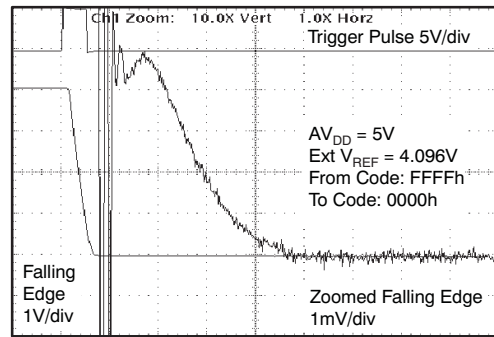

Figure 45.

**HALF-SCALE SETTLING TIME: 5V RISING EDGE**

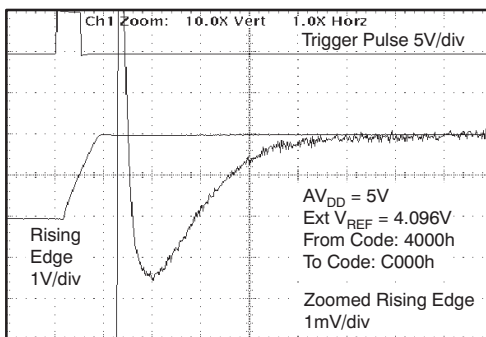

Figure 46.

**HALF-SCALE SETTLING TIME: 5V FALLING EDGE**

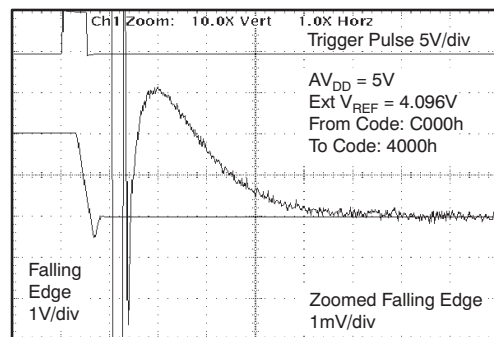
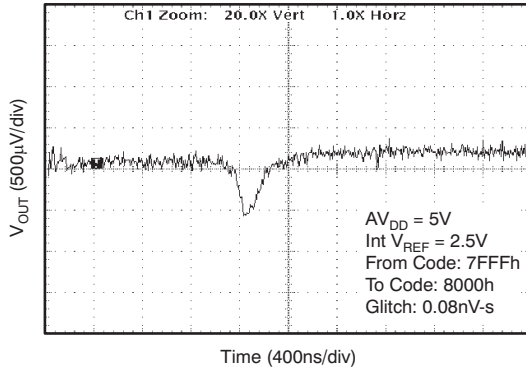

Figure 47.

**TYPICAL CHARACTERISTICS: DAC at  $V_{DD} = 5V$  (continued)**

At  $T_A = +25^\circ C$ , external reference used, DAC output not loaded, and all DAC codes in straight binary data format, unless otherwise noted.

**GLITCH ENERGY:  
5V, 1LSB STEP, RISING EDGE**



**Figure 48.**

**GLITCH ENERGY:  
5V, 1LSB STEP, FALLING EDGE**

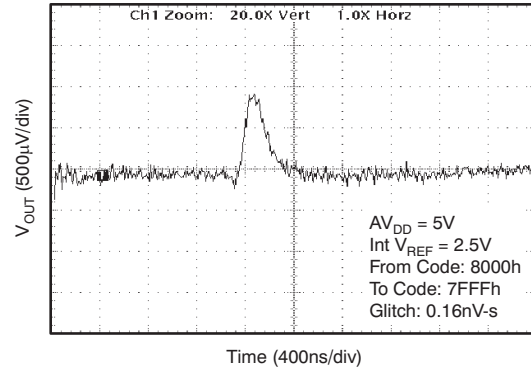

**Figure 49.**

**GLITCH ENERGY:  
5V, 16LSB STEP, RISING EDGE**

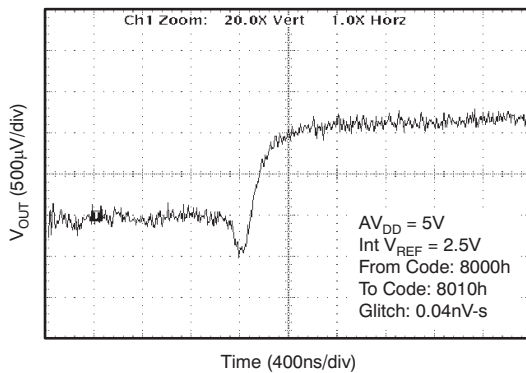

**Figure 50.**

**GLITCH ENERGY:  
5V, 16LSB STEP, FALLING EDGE**

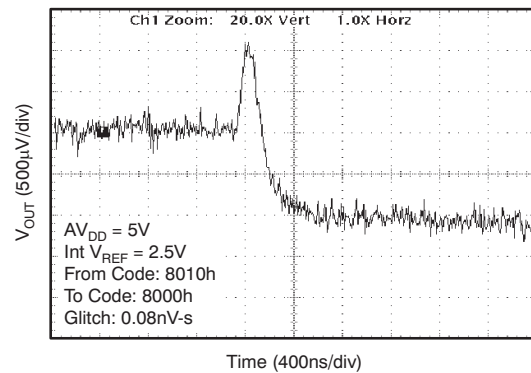

**Figure 51.**

**GLITCH ENERGY:  
5V, 256LSB STEP, RISING EDGE**

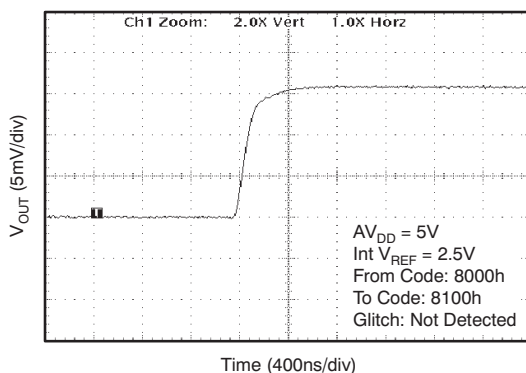

**Figure 52.**

**GLITCH ENERGY:  
5V, 256LSB STEP, FALLING EDGE**

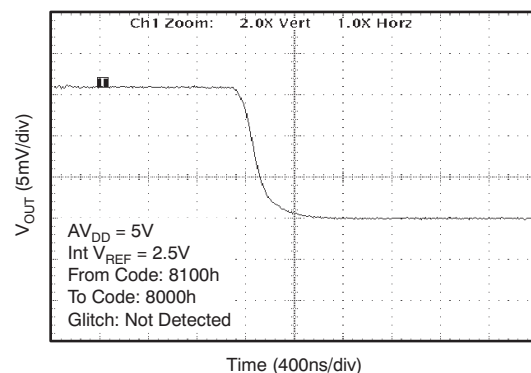

**Figure 53.**

**TYPICAL CHARACTERISTICS: DAC at AV<sub>DD</sub> = 5V (continued)**

At T<sub>A</sub> = +25°C, external reference used, DAC output not loaded, and all DAC codes in straight binary data format, unless otherwise noted.

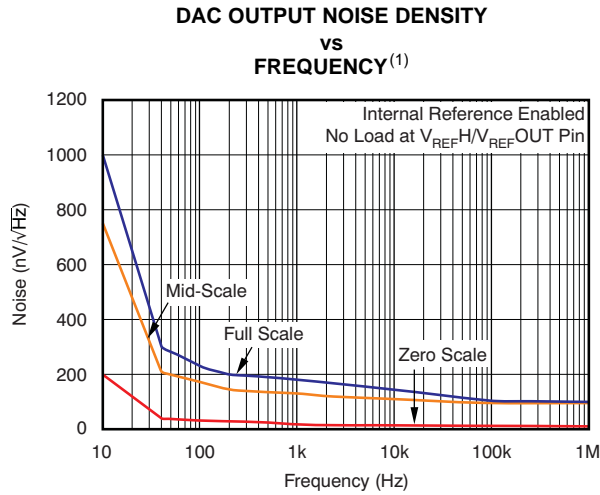

Figure 54.

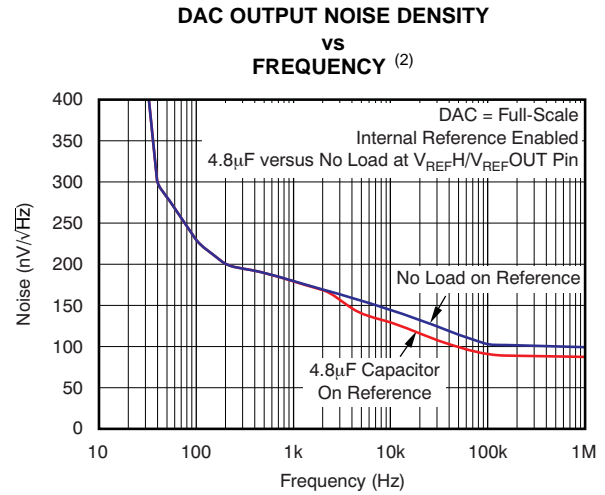

Figure 55.

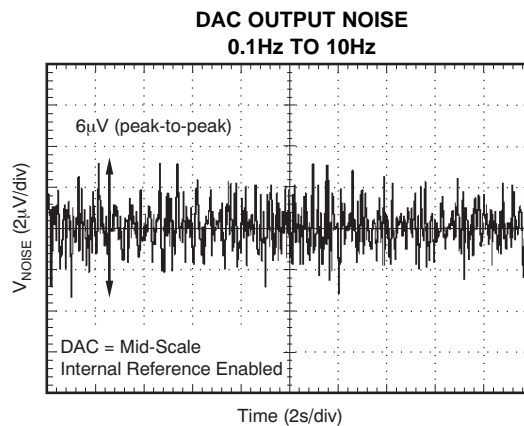

Figure 56.

- (1) Explained in more detail in the [Application Information](#) section of this data sheet.
- (2) See the [Application Information](#) section for more information.

**TYPICAL CHARACTERISTICS: DAC at  $AV_{DD} = 3.6V$**

At  $T_A = +25^\circ C$ , internal reference used, and DAC output not loaded, all DAC codes in straight binary data format, unless otherwise noted

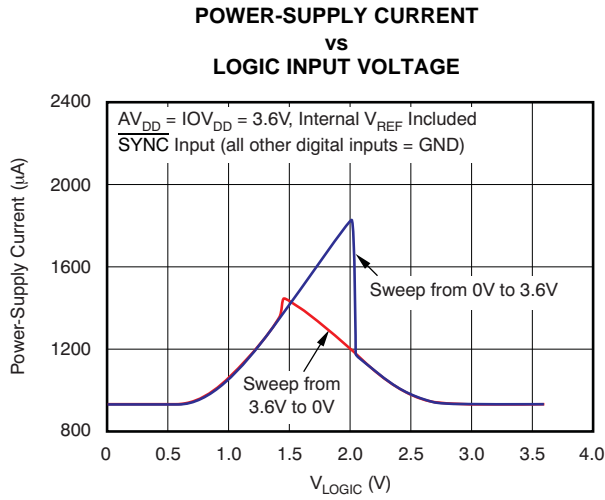

Figure 57.

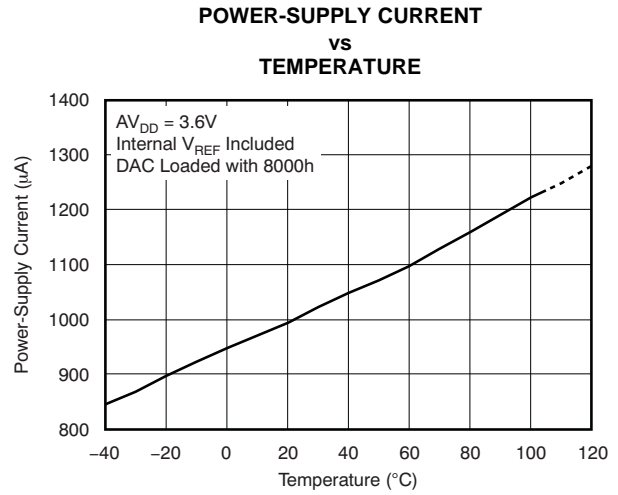

Figure 58.

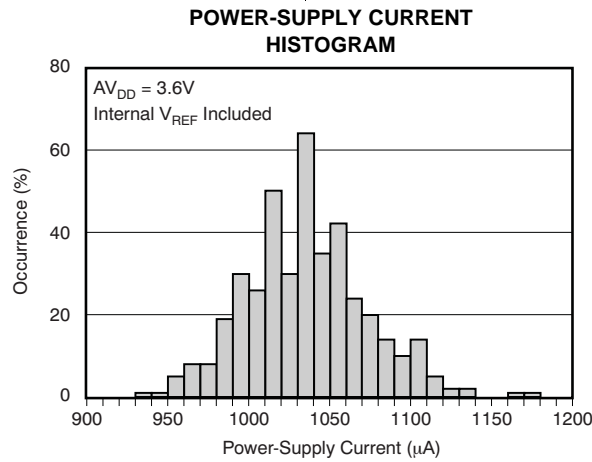

Figure 59.

**TYPICAL CHARACTERISTICS: DAC at  $AV_{DD} = 2.7V$**

At  $T_A = +25^\circ C$ , internal reference used, and DAC output not loaded, all DAC codes in straight binary data format, unless otherwise noted

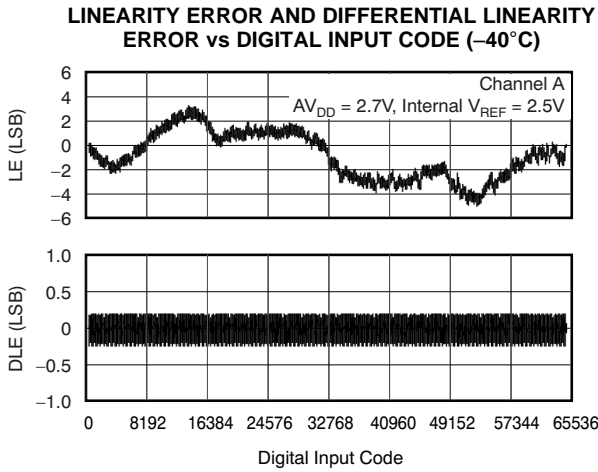

Figure 60.

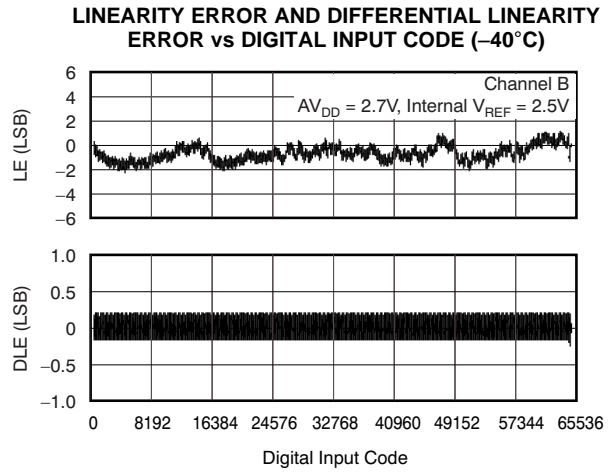

Figure 61.

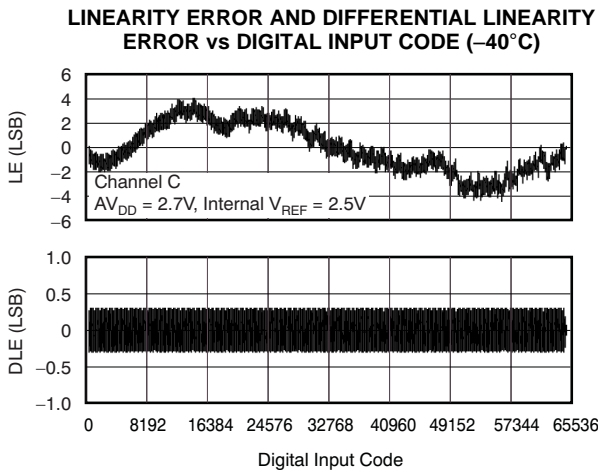

Figure 62.

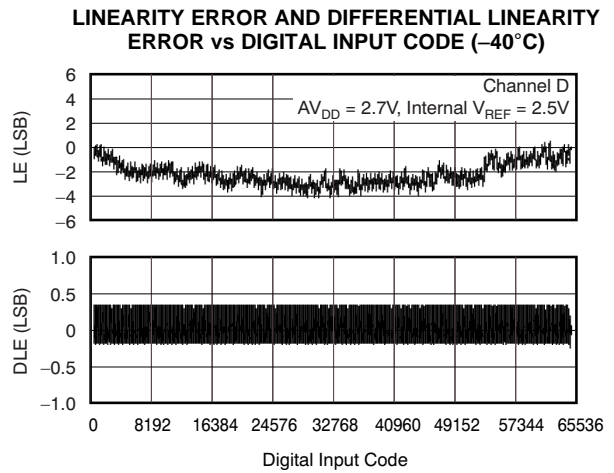

Figure 63.

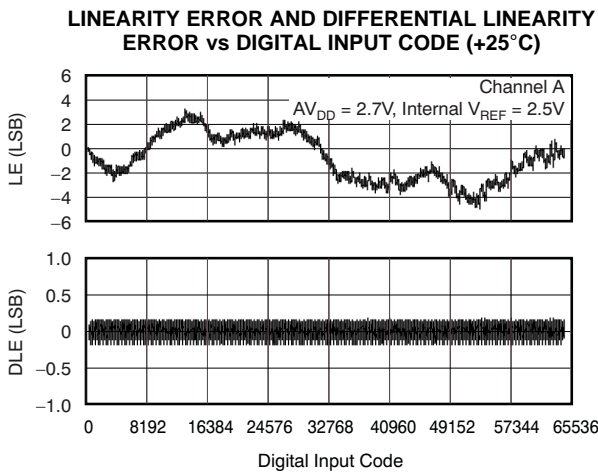

Figure 64.

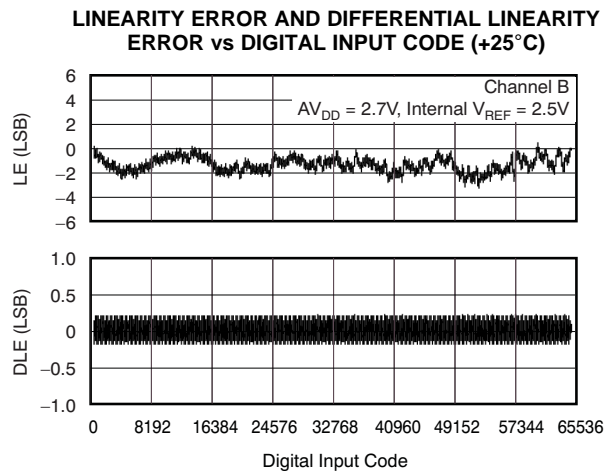

Figure 65.

**TYPICAL CHARACTERISTICS: DAC at  $V_{DD} = 2.7V$  (continued)**

At  $T_A = +25^\circ C$ , internal reference used, and DAC output not loaded, all DAC codes in straight binary data format, unless otherwise noted

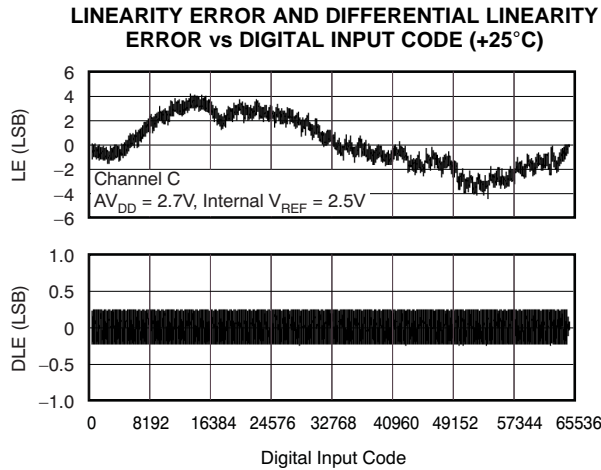

Figure 66.

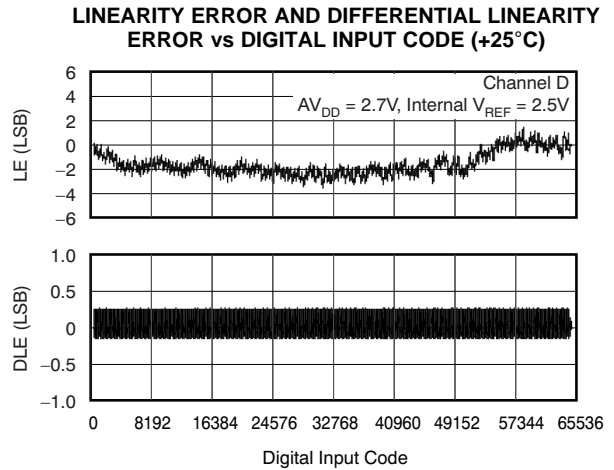

Figure 67.

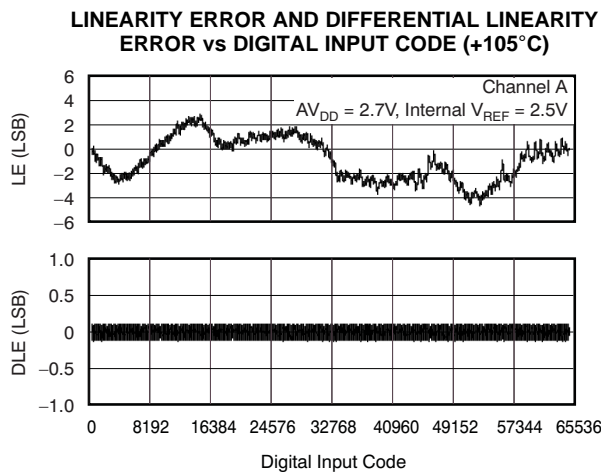

Figure 68.

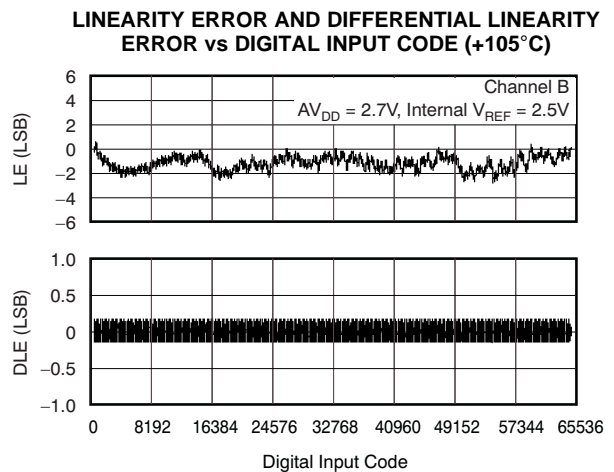

Figure 69.

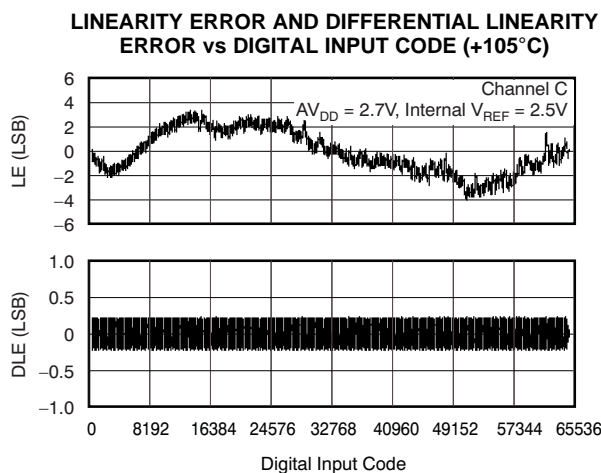

Figure 70.

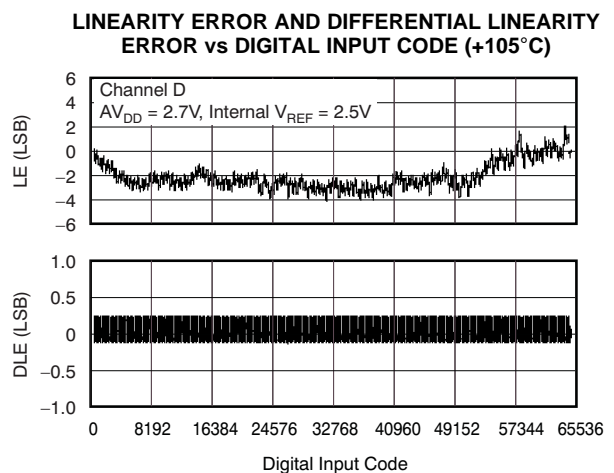

Figure 71.

**TYPICAL CHARACTERISTICS: DAC at  $V_{DD} = 2.7V$  (continued)**

At  $T_A = +25^\circ C$ , internal reference used, and DAC output not loaded, all DAC codes in straight binary data format, unless otherwise noted

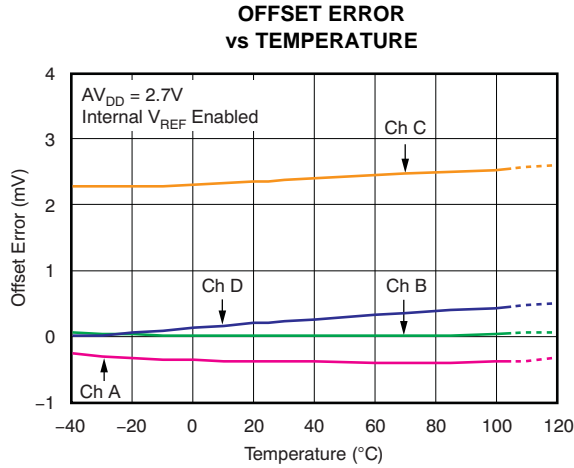

Figure 72.

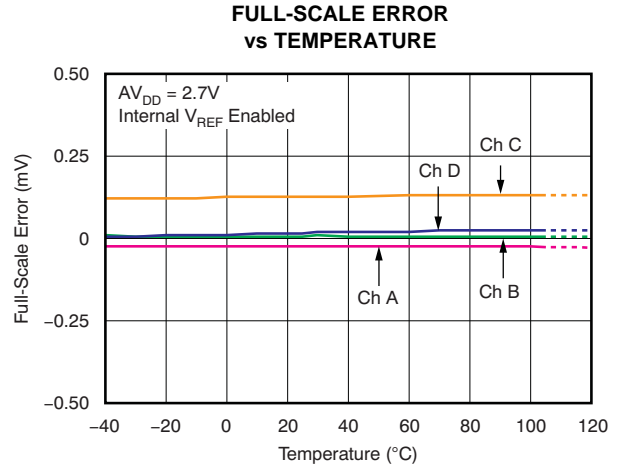

Figure 73.

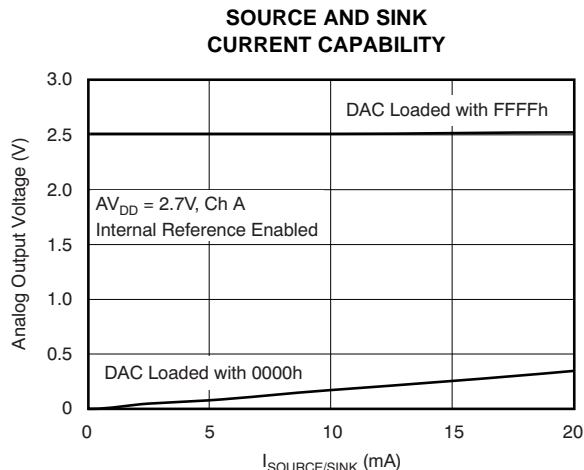

Figure 74.

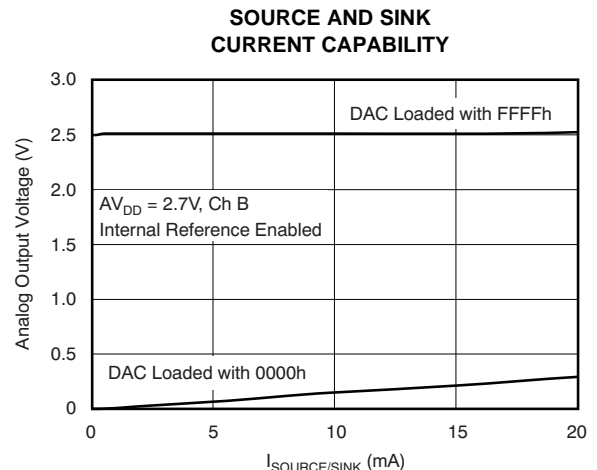

Figure 75.

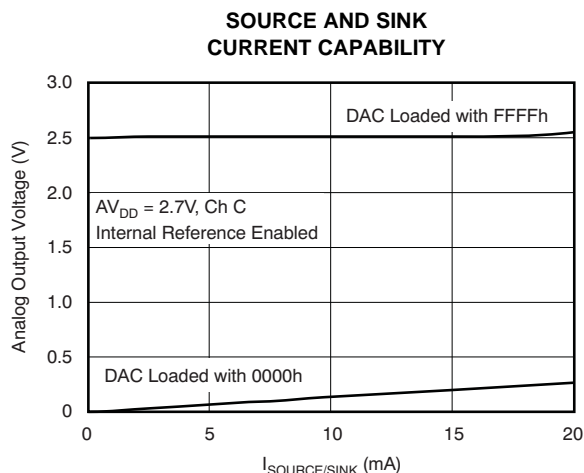

Figure 76.

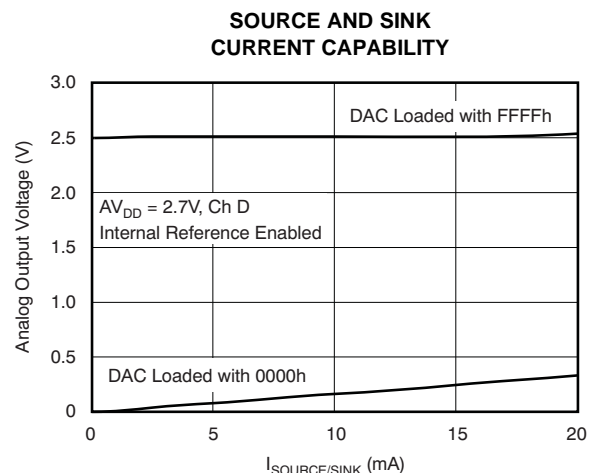
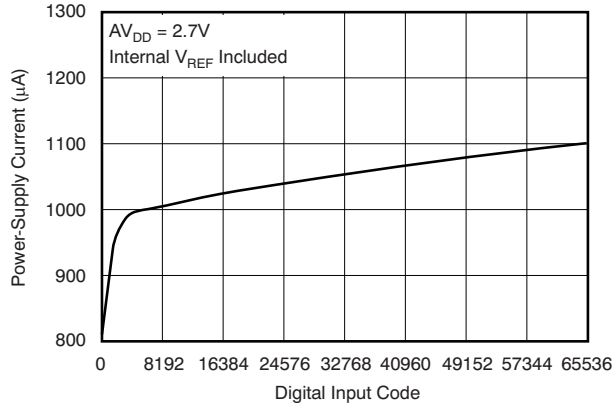

Figure 77.

**TYPICAL CHARACTERISTICS: DAC at AV<sub>DD</sub> = 2.7V (continued)**

At T<sub>A</sub> = +25°C, internal reference used, and DAC output not loaded, all DAC codes in straight binary data format, unless otherwise noted

**POWER-SUPPLY CURRENT vs DIGITAL INPUT CODE**



**Figure 78.**

**POWER-SUPPLY CURRENT vs LOGIC INPUT VOLTAGE**

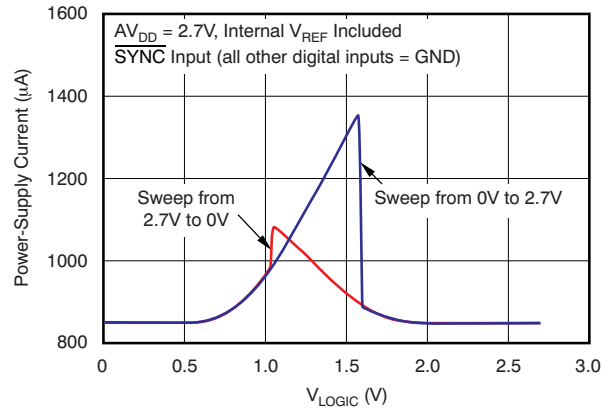

**Figure 79.**

**FULL-SCALE SETTLING TIME: 2.7V RISING EDGE**

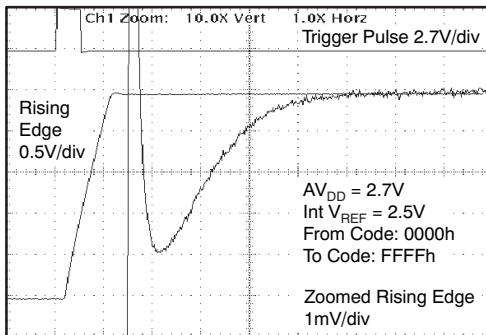

Time (2µs/div)

**Figure 80.**

**FULL-SCALE SETTLING TIME: 2.7V FALLING EDGE**

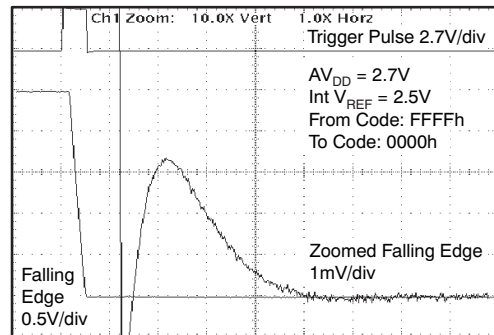

Time (2µs/div)

**Figure 81.**

**HALF-SCALE SETTLING TIME: 2.7V RISING EDGE**

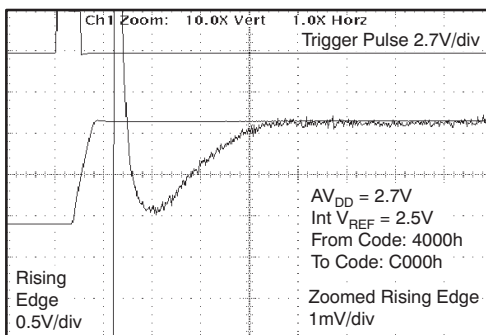

Time (2µs/div)

**Figure 82.**

**HALF-SCALE SETTLING TIME: 2.7V FALLING EDGE**

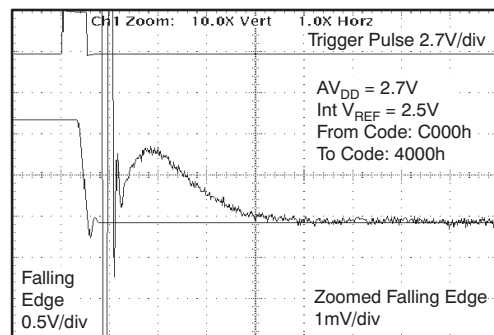

Time (2µs/div)

**Figure 83.**

**TYPICAL CHARACTERISTICS: DAC at  $V_{DD} = 2.7V$  (continued)**

At  $T_A = +25^\circ C$ , internal reference used, and DAC output not loaded, all DAC codes in straight binary data format, unless otherwise noted

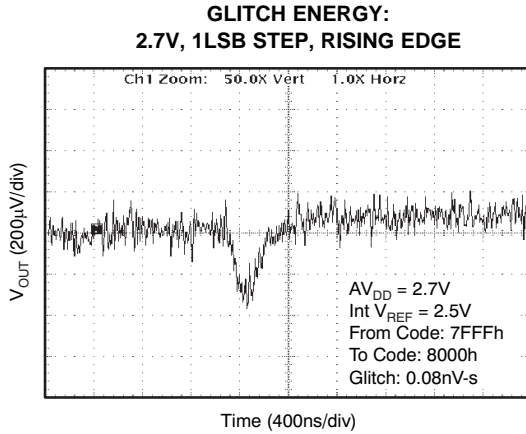

Figure 84.

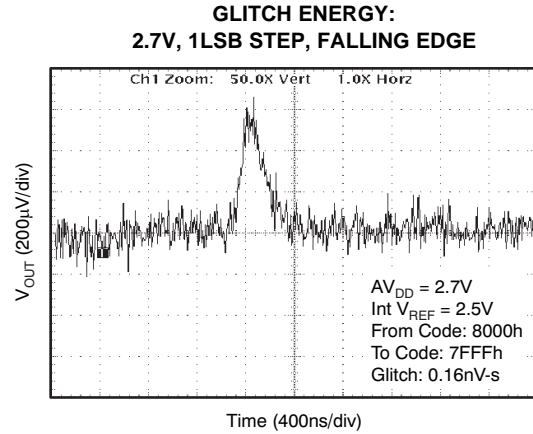

Figure 85.

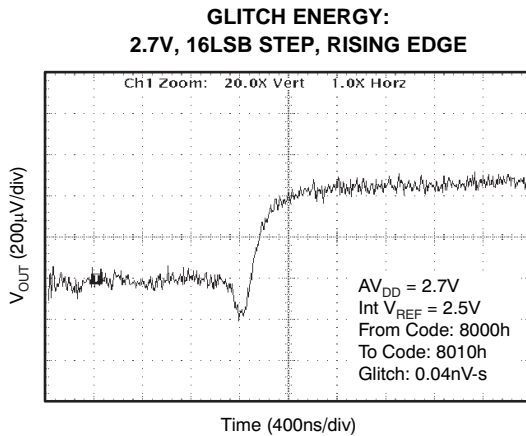

Figure 86.

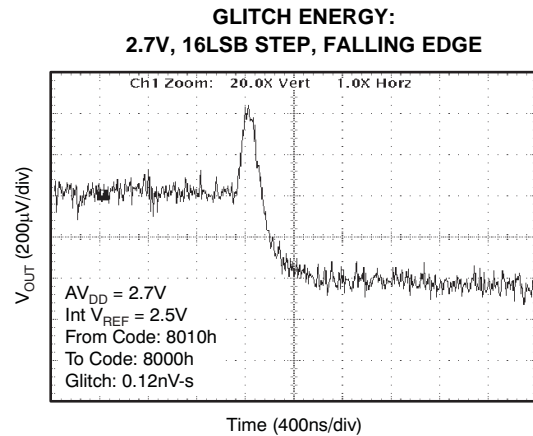

Figure 87.

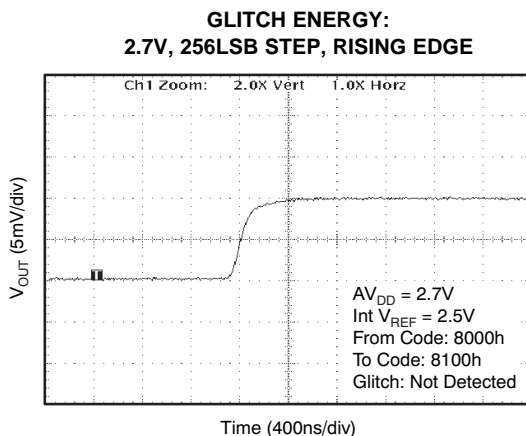

Figure 88.

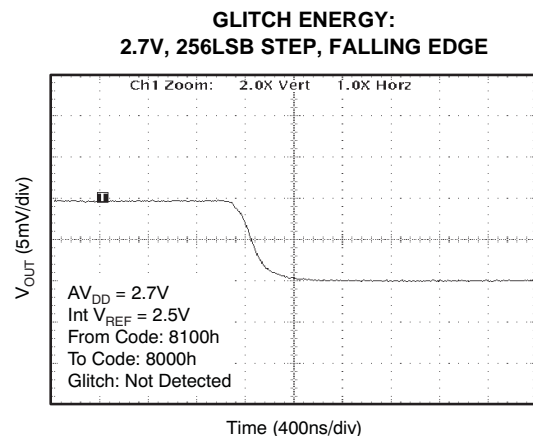
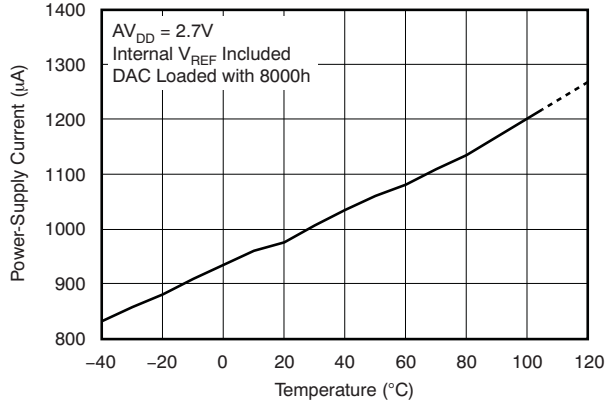

Figure 89.

**TYPICAL CHARACTERISTICS: DAC at  $V_{DD} = 2.7V$  (continued)**

At  $T_A = +25^\circ C$ , internal reference used, and DAC output not loaded, all DAC codes in straight binary data format, unless otherwise noted

**POWER-SUPPLY CURRENT vs TEMPERATURE**



**Figure 90.**

**POWER-DOWN CURRENT vs TEMPERATURE**

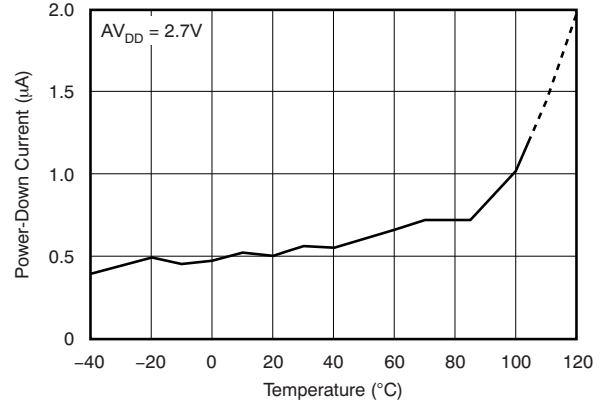
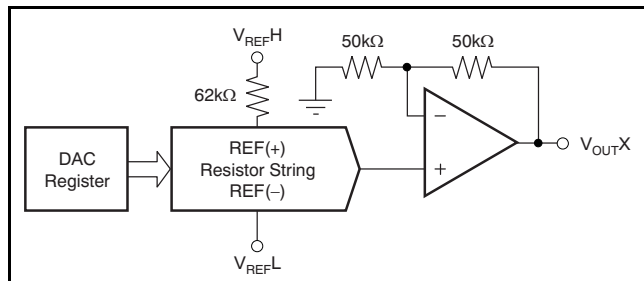

**Figure 91.**

## THEORY OF OPERATION

### DIGITAL-TO-ANALOG CONVERTER (DAC)

The DAC8565 architecture consists of a string DAC followed by an output buffer amplifier. Figure 92 shows a block diagram of the DAC architecture.



**Figure 92. DAC8565 Architecture**

The input coding to the DAC8565 can be straight binary or two's complement, so the ideal output voltage is given by Equation 1.

$$V_{OUTX} = 2 \times V_{REFL} + (V_{REFH} - V_{REFL}) \times \frac{D_{IN}}{65536} \quad (1)$$

where  $D_{IN}$  = decimal equivalent of the binary code that is loaded to the DAC register; it can range from 0 to 65535. X represents channel A, B, C, or D.

### DATA FORMAT

The data format can be straight binary or two's complement. Table 1 illustrates the differences between USB (unsigned straight binary) and BTC (binary two's complement) data formats.

**Table 1. USB and BTC Codes**

USB CODE	BTC CODE	DESCRIPTION
FFFFh	7FFFh	+Full-Scale – 1LSB
...		
8001h	0001h	Midscale + 1LSB
8000h	0000h	Midscale
7FFFh	FFFFh	Midscale – 1LSB
...		
0000h	8000h	Zero Scale

### RESISTOR STRING

The resistor string section is shown in Figure 93. It is simply a string of resistors, each of value  $R$ . The

code loaded into the DAC register determines at which node on the string the voltage is tapped off to be fed into the output amplifier by closing one of the switches connecting the string to the amplifier. It is monotonic because it is a string of resistors.

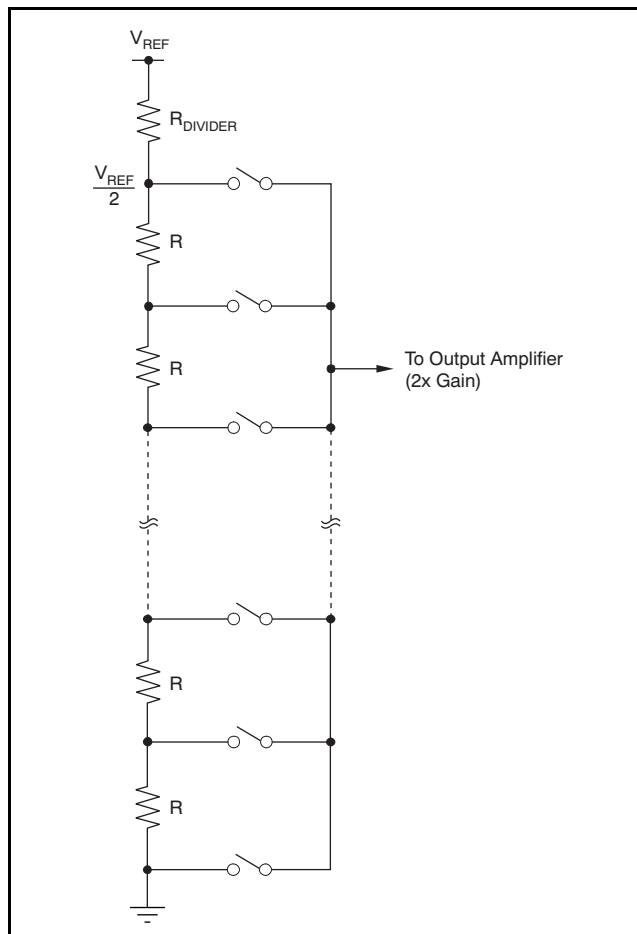

**Figure 93. Resistor String**

### OUTPUT AMPLIFIER

The output buffer amplifier is capable of generating rail-to-rail voltages on its output, giving an output range of 0V to  $AV_{DD}$ . It is capable of driving a load of  $2k\Omega$  in parallel with  $1000pF$  to GND. The source and sink capabilities of the output amplifier can be seen in the Typical Characteristics. The slew rate is  $2.2V/\mu s$ , with a full-scale settling time of  $8\mu s$  with the output unloaded.

### INTERNAL REFERENCE

The DAC8565 includes a 2.5V internal reference that is enabled by default. The internal reference is externally available at the  $V_{REFH}/V_{REFOUT}$  pin. A minimum 100nF capacitor is recommended between the reference output and GND for noise filtering.

The internal reference of the DAC8565 is a bipolar transistor-based, precision bandgap voltage reference. Figure 94 shows the basic bandgap topology. Transistors  $Q_1$  and  $Q_2$  are biased such that the current density of  $Q_1$  is greater than that of  $Q_2$ . The difference of the two base-emitter voltages ( $V_{BE1} - V_{BE2}$ ) has a positive temperature coefficient and is forced across resistor  $R_1$ . This voltage is gained up and added to the base-emitter voltage of  $Q_2$ , which has a negative temperature coefficient. The resulting output voltage is virtually independent of temperature. The short-circuit current is limited by design to approximately 100mA.

#### Enable/Disable Internal Reference

The internal reference in the DAC8565 is enabled by default and operates in automatic mode; however, the reference can be disabled for debugging, evaluation purposes, or when using an external reference. A serial command that requires a 24-bit write sequence (see the [Serial Interface](#) section) must be used to disable the internal reference, as shown in Table 2. During the time that the internal reference is disabled, the DAC functions normally using an external reference. At this point, the internal reference is disconnected from the  $V_{REFH}/V_{REFOUT}$  pin (3-state output). Do not attempt to drive the  $V_{REFH}/V_{REFOUT}$  pin externally and internally at the same time indefinitely.

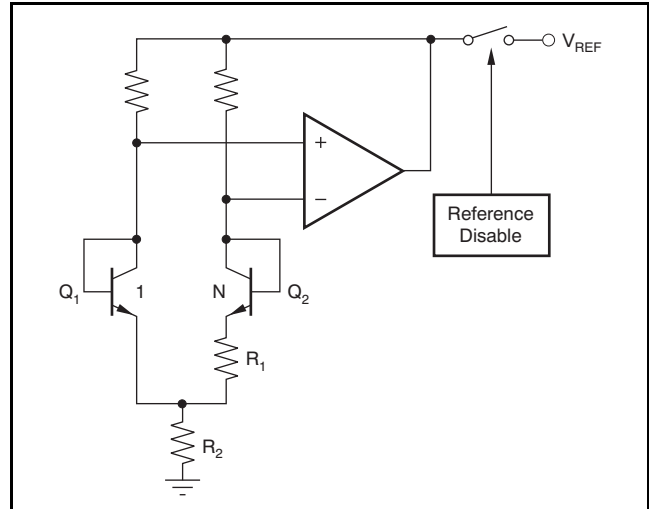

Figure 94. Simplified Schematic of the Bandgap Reference

To then enable the internal reference, either perform a power-cycle to reset the device, or write the 24-bit serial command shown in Table 3. These actions put the internal reference back into the default mode. In the default mode, the internal reference powers down automatically when all DACs power down in any of the power-down modes (see the [Power-Down Modes](#) section); the internal reference powers up automatically when any DAC is powered up.

The DAC8565 also provides the option of keeping the internal reference powered on all the time, regardless of the DAC(s) state (powered up or down). To keep the internal reference powered on, regardless of the DAC(s) state, write the 24-bit serial command shown in Table 4.

Table 2. Write Sequence for Disabling Internal Reference (internal reference always powered down—012000h)

DB23	DB16							DB13				DB0											
0	0	0	0	0	0	0	0	1	0	0	1	0	0	0	0	0	0	0	0	0	0	0	0
----- Data Bits -----																							

Table 3. Write Sequence for Enabling Internal Reference (internal reference powered up to default mode—010000h)

DB23	DB16							DB0																
0	0	0	0	0	0	0	0	1	0	0	0	0	0	0	0	0	0	0	0	0	0	0	0	0
----- Data Bits -----																								

Table 4. Write Sequence for Enabling Internal Reference (internal reference always powered up—011000h)

DB23	DB16							DB12				DB0												
0	0	0	0	0	0	0	0	1	0	0	0	1	0	0	0	0	0	0	0	0	0	0	0	0
----- Data Bits -----																								

## SERIAL INTERFACE

The DAC8565 has a 3-wire serial interface ( $\overline{\text{SYNC}}$ , SCLK, and  $D_{\text{IN}}$ ) compatible with SPI, QSPI, and Microwire interface standards, as well as most DSPs. See the [Serial Write Operation](#) timing diagram for an example of a typical write sequence.

The DAC8565 input shift register is 24 bits wide, consisting of eight control bits (DB23 to DB16) and 16 data bits (DB15 to DB0). All 24 bits of data are loaded into the DAC under the control of the serial clock input, SCLK. DB23 (MSB) is the first bit that is loaded into the DAC shift register, and is followed by the rest of the 24-bit word pattern, left-aligned. This configuration means that the first 24 bits of data are latched into the shift register and any further clocking of data is ignored. The DAC8565 receives all 24 bits of data and decodes the first eight bits to determine the DAC operating/control mode. The 16 bits of data that follow are decoded by the DAC to determine the equivalent analog output. The data format is straight binary with all '0's corresponding to 0V output and all '1's corresponding to full-scale output (that is,  $V_{\text{REF}} - 1$  LSB); see the [Data Format](#) section for more details.

The write sequence begins by bringing the  $\overline{\text{SYNC}}$  line low. Data from the  $D_{\text{IN}}$  line are clocked into the 24-bit shift register on each falling edge of SCLK. The serial clock frequency can be as high as 50MHz, making the DAC8565 compatible with high-speed DSPs. On the 24th falling edge of the serial clock, the last data bit is clocked into the shift register and the shift register locks. Further clocking does not change the shift register data. Once 24 bits are locked into the shift register, the eight MSBs are used as control bits and the 16 LSBs are used as data. After receiving the 24th falling clock edge, the DAC8565 decodes the eight control bits and 16 data bits to perform the required function, without waiting for a  $\overline{\text{SYNC}}$  rising edge. A new write sequence starts at the next falling edge of  $\overline{\text{SYNC}}$ . A rising edge of  $\overline{\text{SYNC}}$  before the 24-bit sequence is complete resets the SPI interface; no data transfer occurs. After the 24th falling edge of SCLK is received, the  $\overline{\text{SYNC}}$  line may be kept LOW or brought HIGH. In either case, the minimum delay time from the 24th falling SCLK edge to the next falling  $\overline{\text{SYNC}}$  edge must be met in order to properly begin the next cycle. To assure the lowest power

consumption of the device, care should be taken that the levels are as close to each rail as possible. Refer to the [Typical Characteristics](#) section for [Figure 36](#), [Figure 57](#), and [Figure 79](#) (*Supply Current vs Logic Input Voltage*).

## IOV<sub>DD</sub> AND VOLTAGE TRANSLATORS

The IOV<sub>DD</sub> pin powers the the digital input structures of the DAC8565. For single-supply operation, it can be tied to AV<sub>DD</sub>. For dual-supply operation, the IOV<sub>DD</sub> pin provides interface flexibility with various CMOS logic families and should be connected to the logic supply of the system. Analog circuits and internal logic of the DAC8565 use AV<sub>DD</sub> as the supply voltage. The external logic high inputs translate to AV<sub>DD</sub> by level shifters. These level shifters use the IOV<sub>DD</sub> voltage as a reference to shift the incoming logic HIGH levels to AV<sub>DD</sub>. IOV<sub>DD</sub> is ensured to operate from 2.7V to 5.5V regardless of the AV<sub>DD</sub> voltage, assuring compatibility with various logic families. Although specified down to 2.7V, IOV<sub>DD</sub> operates at as low as 1.8V with degraded timing and temperature performance. For lowest power consumption, logic V<sub>IH</sub> levels should be as close as possible to IOV<sub>DD</sub>, and logic V<sub>IL</sub> levels should be as close as possible to GND voltages.

## ASYNCHRONOUS RESET

The DAC8565 output is asynchronously set to zero-scale voltage or midscale voltage (depending on RSTSEL) immediately after the RST pin is brought low. The RST signal resets all internal registers, and therefore, behaves like the Power-On Reset. The RST pin must be brought back to high before a write sequence starts. If the RSTSEL pin is high, the RST signal going low resets all outputs to midscale. If the RSTSEL pin is low, the RST signal going low resets all outputs to zero-scale. RSTSEL should be set at power-up.

## INPUT SHIFT REGISTER

The input shift register (SR) of the DAC8565 is 24 bits wide, as shown in [Table 5](#). It consists of eight control bits (DB23 to DB16) and 16 data bits (DB15 to DB0). DB23 and DB22 should always be '0'.

**Table 5. DAC8565 Data Input Register Format**

DB23												DB12			
0	0	LD1	LD0	0	DAC Select 1	DAC Select 0	PD0	D15	D14	D13	D12				
DB11												DB0			
D11	D10	D9	D8	D7	D6	D5	D4	D3	D2	D1	D0				

LD1 (DB21) and LD0 (DB20) control the updating of each analog output with the specified 16-bit data value or power-down command. Bit DB19 must always be '0'. The DAC channel select bits (DB18, DB17) control the destination of the data (or power-down command) from DAC A to DAC D. The final control bit, PD0 (DB16), selects the power-down mode of the DAC8565 channels as well as the power-down mode of the internal reference.

The DAC8565 supports a number of different load commands. The load commands include broadcast commands to address all the DAC8565s on an SPI bus. The load commands are summarized as follows:

**DB21 = 0 and DB20 = 0: Single-channel store.** The temporary register (data buffer) corresponding to a DAC selected by DB18 and DB17 updates with the contents of SR data (or power-down).

**DB21 = 0 and DB20 = 1: Single-channel update.** The temporary register and DAC register corresponding to a DAC selected by DB18 and DB17 are updated with the contents of SR data (or power-down).

**DB21 = 1 and DB20 = 0: Simultaneous update.** A channel selected by DB18 and DB17 updates with the SR data; simultaneously, all the other channels update with previously stored data (or power-down) from temporary registers.

**DB21 = 1 and DB20 = 1: Broadcast update.** If DB18 = 0, then SR data are ignored and all channels are updated with previously stored data (or power-down). If DB18 = 1, then SR data (or power-down) updates all channels. Refer to [Table 6](#) for more information.

**Table 6. Control Matrix for the DAC8565**

DB23	DB22	DB21	DB20	DB19	DB18	DB17	DB16	DB15	DB14	DB13-DB0	DESCRIPTION
0	0	LD 1	LD 0	0	DAC Sel 1	DAC Sel 0	PD0	MSB	MSB-1	MSB-2...LSB	
		0	0	0	0	0	0	Data			Write to buffer A with data
		0	0	0	0	1	0	Data			Write to buffer B with data
		0	0	0	1	0	0	Data			Write to buffer C with data
		0	0	0	1	1	0	Data			Write to buffer D with data
		0	0	0	(00, 01, 10, or 11)		1	See <a href="#">Table 7</a>		0	Write to buffer (selected by DB17 and DB18) with power-down command
		0	1	0	(00, 01, 10, or 11)		0	Data			Write to buffer with data and load DAC (selected by DB17 and DB18)
		0	1	0	(00, 01, 10, or 11)		1	See <a href="#">Table 7</a>		0	Write to buffer with power-down command and load DAC (selected by DB17 and DB18)
		1	0	0	(00, 01, 10, or 11)		0	Data			Write to buffer with data (selected by DB17 and DB18) and then load all DACs simultaneously from their corresponding buffers
		1	0	0	(00, 01, 10, or 11)		1	See <a href="#">Table 7</a>		0	Write to buffer with power-down command (selected by DB17 and DB18) and then load all DACs simultaneously from their corresponding buffers
<b>Broadcast Modes</b>											
X	X	1	1	0	0	X	X	X			Simultaneously update all channels of DAC8565 with data stored in each channels temporary register
X	X	1	1	0	1	X	0	Data			Write to all channels and load all DACs with SR data
X	X	1	1	0	1	X	1	See <a href="#">Table 7</a>		0	Write to all channels and load all DACs with power-down command in SR

## SYNC INTERRUPT

In a normal write sequence, the  $\overline{\text{SYNC}}$  line stays low for at least 24 falling edges of SCLK and the addressed DAC register updates on the 24th falling edge. However, if  $\overline{\text{SYNC}}$  is brought high before the 24th falling edge, it acts as an interrupt to the write sequence; the shift register resets and the write sequence is discarded. Neither an update of the data buffer contents, DAC register contents, nor a change in the operating mode occurs (as shown in Figure 95).

## POWER-ON RESET TO ZERO-SCALE OR MIDSCALE

The DAC8565 contains a power-on reset circuit that controls the output voltage during power-up. Depending on the RSTSEL signal, on power-up, the DAC registers are reset and the output voltages are set to zero-scale (RSTSEL = 0) or midscale (RSTSEL = 1); they remain that way until a valid write sequence and load command are made to the respective DAC channel. The power-on reset is useful in applications where it is important to know the state of the output of each DAC while the device is in the process of powering up.

No device pin should be brought high before power is applied to the device. The internal reference is powered on by default and remains that way until a valid reference-change command is executed.

## LDAC FUNCTIONALITY

The DAC8565 offer both a software and hardware simultaneous update function. The DAC double-buffered architecture has been designed so that new data can be entered for each DAC without disturbing the analog outputs.

DAC8565 data updates are *synchronized* with the falling edge of the 24th SCLK cycle, which follows a falling edge of  $\overline{\text{SYNC}}$ . For such *synchronous* updates, the LDAC pin is not required and it must be connected to GND permanently. The LDAC pin is used as a positive edge triggered timing signal for *asynchronous* DAC updates. To do an LDAC operation, single-channel store(s) should be done (loading DAC buffers) by setting LD0 and LD1 to '0'. Multiple single-channel updates can be done in order to set different channel buffers to desired values and then make a rising edge on LDAC. Data buffers of all channels must be loaded with desired data before an LDAC rising edge. After a low-to-high LDAC transition, all DACs are simultaneously updated with the contents of the corresponding data buffers. If the contents of a data buffer are not changed by the serial interface, the corresponding DAC output remains unchanged after the LDAC trigger.

## ENABLE PIN

For normal operation, the enable pin must be driven to a logic low. If the enable pin is driven high, the DAC8565 stops listening to the serial port. However, SCLK,  $\overline{\text{SYNC}}$ , and  $D_{\text{IN}}$  must not be kept floating, but must be at some logic level. This feature can be useful for applications that share the same serial port.

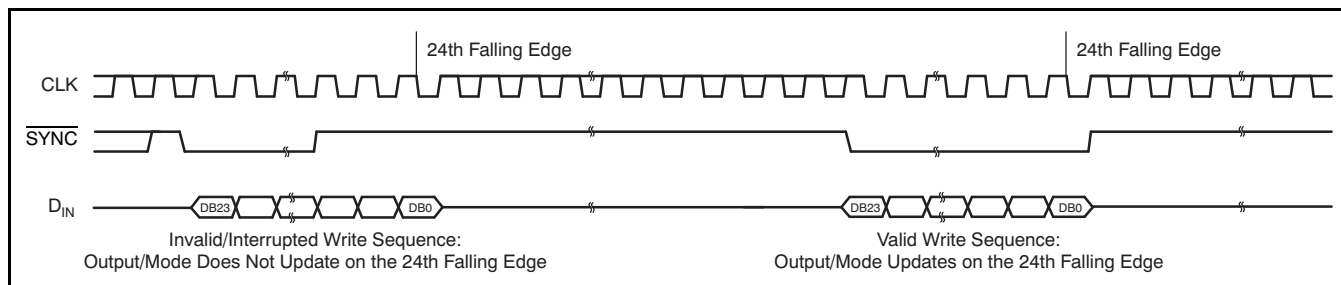

Figure 95.  $\overline{\text{SYNC}}$  Interrupt Facility

## POWER-DOWN MODES

The DAC8565 has two separate sets of power-down commands. One set is for the DAC channels and the other set is for the internal reference. For more information on powering down the reference, see the [Enable/Disable Internal Reference](#) section.

### DAC Power-Down Commands

The DAC8565 use four modes of operation. These modes are accessed by setting three bits (PD2, PD1, and PD0) in the shift register. [Table 7](#) shows how to control the operating mode with data bits PD0 (DB16), PD1 (DB15), and PD2 (DB14).

**Table 7. DAC Operating Modes**

PD0 (DB16)	PD1 (DB15)	PD2 (DB14)	DAC OPERATING MODES
0	X	X	Normal operation
1	0	1	Output typically 1kΩ to GND
1	1	0	Output typically 100 kΩ to GND
1	1	1	Output high-impedance

The DAC8565 treats the power-down condition as data; all the operational modes are still valid for power-down. It is possible to broadcast a power-down condition to all the DAC8565s in a system; it is also possible to simultaneously power-down a channel while updating data on other channels.

When the PD0 bit is set to '0', the device works normally with its typical current consumption of 1mA at 5.5V with an input code = 32768. The reference current is included with the operation of all four

DACs. However, for the three power-down modes, the supply current falls to 1.3μA at 5.5V (0.5μA at 3.6V). Not only does the supply current fall, but the output stage also switches internally from the output of the amplifier to a resistor network of known values.

The advantage of this switching is that the output impedance of the device is known while it is in power-down mode. As described in [Table 7](#), there are three different power-down options.  $V_{OUT}$  can be connected internally to GND through a 1kΩ resistor, a 100kΩ resistor, or open circuited (High-Z). The output stage is shown in [Figure 96](#). In other words, DB16, DB15, and DB14 = '111' represent a power-down condition with Hi-Z output impedance for a selected channel. '101' represents a power-down condition with 1kΩ output impedance, and '110' represents a power-down condition with 100kΩ output impedance.

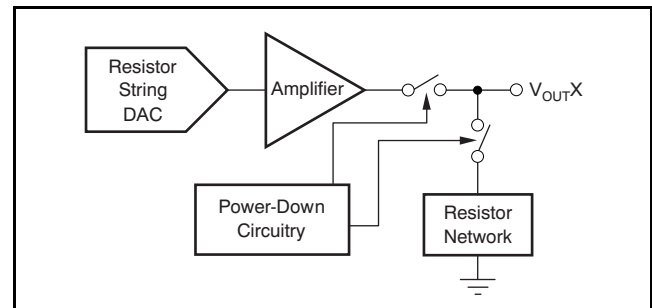

**Figure 96. Output Stage During Power-Down**

All analog channel circuitries are shut down when the power-down mode is exercised. However, the contents of the DAC register are unaffected when in power down. The time required to exit power-down is typically 2.5μs for  $V_{DD} = 5V$ , and 5μs for  $V_{DD} = 3V$ . See the [Typical Characteristics](#) for more information.

**OPERATING EXAMPLES: DAC8565**

For the following examples, X = *don't care*. Value can be either '0' or '1'.

**Example 1: Write to Data Buffer A Through Buffer D; Load DAC A Through DAC D Simultaneously**

- 1st: Write to data buffer A:

DB23	DB22	DB21 (LD1)	DB20 (LD0)	DB19	DB18 (DAC Sel 1)	DB17 (DAC Sel 0)	DB16 (PD0)	DB15	DB14	DB13	DB12	DB11–DB0
0	0	0	0	0	0	0	0	D15	D14	D13	D12	D11–D0

- 2nd: Write to data buffer B:

DB23	DB22	DB21 (LD1)	DB20 (LD0)	DB19	DB18 (DAC Sel 1)	DB17 (DAC Sel 0)	DB16 (PD0)	DB15	DB14	DB13	DB12	DB11–DB0
0	0	0	0	0	0	1	0	D15	D14	D13	D12	D11–D0

- 3rd: Write to data buffer C:

DB23	DB22	DB21 (LD1)	DB20 (LD0)	DB19	DB18 (DAC Sel 1)	DB17 (DAC Sel 0)	DB16 (PD0)	DB15	DB14	DB13	DB12	DB11–DB0
0	0	0	0	0	1	0	0	D15	D14	D13	D12	D11–D0

- 4th: Write to data buffer D and simultaneously update all DACs:

DB23	DB22	DB21 (LD1)	DB20 (LD0)	DB19	DB18 (DAC Sel 1)	DB17 (DAC Sel 0)	DB16 (PD0)	DB15	DB14	DB13	DB12	DB11–DB0
0	0	1	0	0	1	1	0	D15	D14	D13	D12	D11–D0

The DAC A, DAC B, DAC C, and DAC D analog outputs simultaneously settle to the specified values upon completion of the 4th write sequence. (The DAC voltages update simultaneously after the 24th SCLK falling edge of the fourth write cycle).

**Example 2: Load New Data to DAC A Through DAC D Sequentially**

- 1st: Write to data buffer A and load DAC A: DAC A output settles to specified value upon completion:

DB23	DB22	DB21 (LD1)	DB20 (LD0)	DB19	DB18 (DAC Sel 1)	DB17 (DAC Sel 0)	DB16 (PD0)	DB15	DB14	DB13	DB12	DB11–DB0
0	0	0	1	0	0	0	0	D15	D14	D13	D12	D11–D0

- 2nd: Write to data buffer B and load DAC B: DAC B output settles to specified value upon completion:

DB23	DB22	DB21 (LD1)	DB20 (LD0)	DB19	DB18 (DAC Sel 1)	DB17 (DAC Sel 0)	DB16 (PD0)	DB15	DB14	DB13	DB12	DB11–DB0
0	0	0	1	0	0	1	0	D15	D14	D13	D12	D11–D0

- 3rd: Write to data buffer C and load DAC C: DAC C output settles to specified value upon completion:

DB23	DB22	DB21 (LD1)	DB20 (LD0)	DB19	DB18 (DAC Sel 1)	DB17 (DAC Sel 0)	DB16 (PD0)	DB15	DB14	DB13	DB12	DB11–DB0
0	0	0	1	0	1	0	0	D15	D14	D13	D12	D11–D0

- 4th: Write to data buffer D and load DAC D: DAC D output settles to specified value upon completion:

DB23	DB22	DB21 (LD1)	DB20 (LD0)	DB19	DB18 (DAC Sel 1)	DB17 (DAC Sel 0)	DB16 (PD0)	DB15	DB14	DB13	DB12	DB11–DB0
0	0	0	1	0	1	1	0	D15	D14	D13	D12	D11–D0

After completion of each write cycle, DAC analog output settles to the voltage specified.

**Example 3: Power-Down DAC A and DAC B to 1kΩ and Power-Down DAC C and DAC D to 100kΩ Simultaneously**

- 1st: Write power-down command to data buffer A: DAC A to 1kΩ.

DB23	DB22	DB21 (LD1)	DB20 (LD0)	DB19	DB18 (DAC Sel 1)	DB17 (DAC Sel 0)	DB16 (PD0)	DB15	DB14	DB13	DB12	DB11–DB0
0	0	0	0	0	0	0	1	0	1	X	X	X

- 2nd: Write power-down command to data buffer B: DAC B to 1kΩ.

DB23	DB22	DB21 (LD1)	DB20 (LD0)	DB19	DB18 (DAC Sel 1)	DB17 (DAC Sel 0)	DB16 (PD0)	DB15	DB14	DB13	DB12	DB11–DB0
0	0	0	0	0	0	1	1	0	1	X	X	X

- 3rd: Write power-down command to data buffer C: DAC C to 100kΩ.

DB23	DB22	DB21 (LD1)	DB20 (LD0)	DB19	DB18 (DAC Sel 1)	DB17 (DAC Sel 0)	DB16 (PD0)	DB15	DB14	DB13	DB12	DB11–DB0
0	0	0	0	0	1	0	1	1	0	X	X	X

- 4th: Write power-down command to data buffer D: DAC D to 100kΩ and simultaneously update all DACs.

DB23	DB22	DB21 (LD1)	DB20 (LD0)	DB19	DB18 (DAC Sel 1)	DB17 (DAC Sel 0)	DB16 (PD0)	DB15	DB14	DB13	DB12	DB11–DB0
0	0	1	0	0	1	1	1	1	0	X	X	X

The DAC A, DAC B, DAC C, and DAC D analog outputs simultaneously power-down to each respective specified mode upon completion of the fourth write sequence.

**Example 4: Power-Down DAC A Through DAC D to High-Impedance Sequentially**

- 1st: Write power-down command to data buffer A and load DAC A: DAC A output = Hi-Z:

DB23	DB22	DB21 (LD1)	DB20 (LD0)	DB19	DB18 (DAC Sel 1)	DB17 (DAC Sel 0)	DB16 (PD0)	DB15	DB14	DB13	DB12	DB11–DB0
0	0	0	1	0	0	0	1	1	1	X	X	X

- 2nd: Write power-down command to data buffer B and load DAC B: DAC B output = Hi-Z:

DB23	DB22	DB21 (LD1)	DB20 (LD0)	DB19	DB18 (DAC Sel 1)	DB17 (DAC Sel 0)	DB16 (PD0)	DB15	DB14	DB13	DB12	DB11–DB0
0	0	0	1	0	0	1	1	1	1	X	X	X

- 3rd: Write power-down command to data buffer C and load DAC C: DAC C output = Hi-Z:

DB23	DB22	DB21 (LD1)	DB20 (LD0)	DB19	DB18 (DAC Sel 1)	DB17 (DAC Sel 0)	DB16 (PD0)	DB15	DB14	DB13	DB12	DB11–DB0
0	0	0	1	0	1	0	1	1	1	X	X	X

- 4th: Write power-down command to data buffer D and load DAC D: DAC D output = Hi-Z:

DB23	DB22	DB21 (LD1)	DB20 (LD0)	DB19	DB18 (DAC Sel 1)	DB17 (DAC Sel 0)	DB16 (PD0)	DB15	DB14	DB13	DB12	DB11–DB0
0	0	0	1	0	1	1	1	1	1	X	X	X

The DAC A, DAC B, DAC C, and DAC D analog outputs sequentially power-down to high-impedance upon completion of the first, second, third, and fourth write sequences, respectively.

**Example 5: Power-Down All Channels Simultaneously while Reference is Always Powered Up**

- 1st: Write sequence for enabling the DAC8565 internal reference all the time:

DB23	DB22	DB21 (LD1)	DB20 (LD0)	DB19	DB18 (DAC Sel 1)	DB17 (DAC Sel 0)	DB16 (PD0)	DB15	DB14	DB13	DB12	DB11–DB0
0	0	0	0	0	0	0	1	0	0	0	1	X

- 2nd: Write sequence to power-down all DACs to high-impedance:

DB23	DB22	DB21 (LD1)	DB20 (LD0)	DB19	DB18 (DAC Sel 1)	DB17 (DAC Sel 0)	DB16 (PD0)	DB15	DB14	DB13	DB12	DB11–DB0
0	0	1	1	0	1	0	1	1	1	X	X	X

The DAC A, DAC B, DAC C, and DAC D analog outputs sequentially power-down to high-impedance upon completion of the first and second write sequences, respectively.

**Example 6: Write a Specific Value to All DACs while Reference is Always Powered Down**

- 1st: Write sequence for disabling the DAC8565 internal reference all the time (after this sequence, the DAC8565 requires an external reference source to function):

DB23	DB22	DB21 (LD1)	DB20 (LD0)	DB19	DB18 (DAC Sel 1)	DB17 (DAC Sel 0)	DB16 (PD0)	DB15	DB14	DB13	DB12	DB11–DB0
0	0	0	0	0	0	0	1	0	0	1	0	X

- 2nd: Write sequence to write specified data to all DACs:

DB23	DB22	DB21 (LD1)	DB20 (LD0)	DB19	DB18 (DAC Sel 1)	DB17 (DAC Sel 0)	DB16 (PD0)	DB15	DB14	DB13	DB12	DB11–DB0
0	0	1	1	0	1	0	0	D15	D14	D13	D12	D11–D0

The DAC A, DAC B, DAC C, and DAC D analog outputs simultaneously settle to the specified values upon completion of the fourth write sequence. (The DAC voltages update simultaneously after the 24th SCLK falling edge of the fourth write cycle). Reference is always powered-down.

**Example 7: Write a Specific Value to DAC A, while Reference is Placed in Default Mode and All Other DACs are Powered Down to High-Impedance**

- 1st: Write sequence for placing the DAC8565 internal reference into default mode. Alternately, this step can be replaced by performing a power-on reset (see the [Power-On Reset](#) section):

DB23	DB22	DB21 (LD1)	DB20 (LD0)	DB19	DB18 (DAC Sel 1)	DB17 (DAC Sel 0)	DB16 (PD0)	DB15	DB14	DB13	DB12	DB11–DB0
0	0	0	0	0	0	0	1	0	0	0	0	X

- 2nd: Write sequence to power-down all DACs to high-impedance (after this sequence, the DAC8565 internal reference powers down automatically):

DB23	DB22	DB21 (LD1)	DB20 (LD0)	DB19	DB18 (DAC Sel 1)	DB17 (DAC Sel 0)	DB16 (PD0)	DB15	DB14	DB13	DB12	DB11–DB0
0	0	1	1	0	1	0	1	1	1	X	X	X

- 3rd: Write sequence to power-up DAC A to a specified value (after this sequence, the DAC8565 internal reference powers up automatically):

DB23	DB22	DB21 (LD1)	DB20 (LD0)	DB19	DB18 (DAC Sel 1)	DB17 (DAC Sel 0)	DB16 (PD0)	DB15	DB14	DB13	DB12	DB11–DB0
0	0	0	1	0	0	0	0	D15	D14	D13	D12	D11–D0

The DAC B, DAC C, and DAC D analog outputs simultaneously power-down to high-impedance, and DAC A settles to the specified value upon completion.

## APPLICATION INFORMATION

### INTERNAL REFERENCE

The internal reference of the DAC8565 does not require an external load capacitor for stability because it is stable with any capacitive load. However, for improved noise performance, an external load capacitor of 150nF or larger connected to the  $V_{REFH}/V_{REFOUT}$  output is recommended. [Figure 97](#) shows the typical connections required for operation of the DAC8565 internal reference. A supply bypass capacitor at the  $AV_{DD}$  input is also recommended.

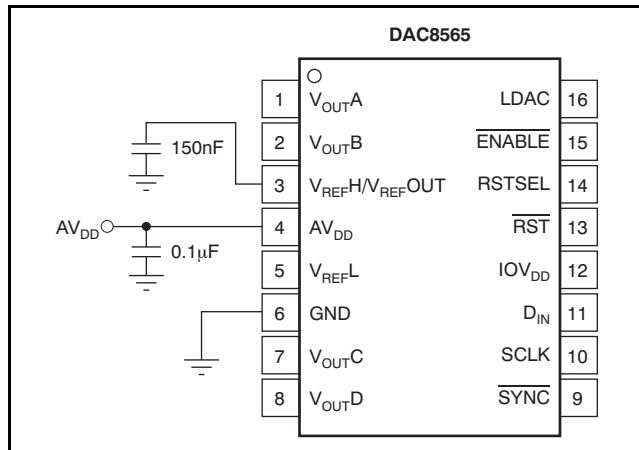

**Figure 97. Typical Connections for Operating the DAC8565 Internal Reference**

### Supply Voltage

The internal reference features an extremely low dropout voltage. It can be operated with a supply of only 5mV above the reference output voltage in an unloaded condition. For loaded conditions, refer to the [Load Regulation](#) section. The stability of the internal reference with variations in supply voltage (line regulation, dc PSRR) is also exceptional. Within the specified supply voltage range of 2.7V to 5.5V, the variation at  $V_{REFH}/V_{REFOUT}$  is less than 10µV/V; see the [Typical Characteristics](#).

### Temperature Drift

The internal reference is designed to exhibit minimal drift error, defined as the change in reference output voltage over varying temperature. The drift is calculated using the *box* method described by [Equation 2](#):

$$\text{Drift Error} = \left( \frac{V_{REF\_MAX} - V_{REF\_MIN}}{V_{REF} \times T_{RANGE}} \right) \times 10^6 \text{ (ppm/}^\circ\text{C)} \quad (2)$$

Where:

$V_{REF\_MAX}$  = maximum reference voltage observed within temperature range  $T_{RANGE}$ .

$V_{REF\_MIN}$  = minimum reference voltage observed within temperature range  $T_{RANGE}$ .

$V_{REF}$  = 2.5V, target value for reference output voltage.

The internal reference (grades C and D) features an exceptional typical drift coefficient of 2ppm/ $^\circ$ C from  $-40^\circ\text{C}$  to  $+120^\circ\text{C}$ . Characterizing a large number of units, a maximum drift coefficient of 5ppm/ $^\circ$ C (grades C and D) is observed. Temperature drift results are summarized in the [Typical Characteristics](#).

### Noise Performance

Typical 0.1Hz to 10Hz voltage noise can be seen in [Figure 8, Internal Reference Noise](#). Additional filtering can be used to improve output noise levels, although care should be taken to ensure the output impedance does not degrade the ac performance. The output noise spectrum at  $V_{REFH}/V_{REFOUT}$  without any external components is depicted in [Figure 7, Internal Reference Noise Density vs Frequency](#). Another noise density spectrum is also shown in [Figure 7](#). This spectrum was obtained using a 4.8µF load capacitor at  $V_{REFH}/V_{REFOUT}$  for noise filtering. Internal reference noise impacts the DAC output noise; see the [DAC Noise Performance](#) section for more details.

## Load Regulation

Load regulation is defined as the change in reference output voltage as a result of changes in load current. The load regulation of the internal reference is measured using force and sense contacts as shown in [Figure 98](#). The force and sense lines reduce the impact of contact and trace resistance, resulting in accurate measurement of the load regulation contributed solely by the internal reference. Measurement results are summarized in the [Typical Characteristics](#). Force and sense lines should be used for applications that require improved load regulation.

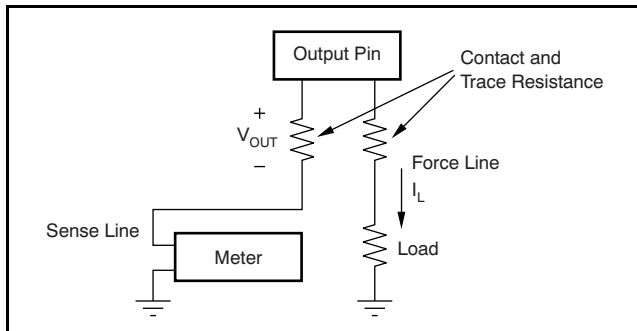

**Figure 98. Accurate Load Regulation of the DAC8565 Internal Reference**

## Long-Term Stability

Long-term stability/aging refers to the change of the output voltage of a reference over a period of months or years. This effect lessens as time progresses (see [Figure 6](#), the typical long-term stability curve). The typical drift value for the internal reference is 50ppm from 0 hours to 1900 hours. This parameter is characterized by powering-up and measuring 20 units at regular intervals for a period of 1900 hours.

## Thermal Hysteresis

Thermal hysteresis for a reference is defined as the change in output voltage after operating the device at +25°C, cycling the device through the operating temperature range, and returning to +25°C. Hysteresis is expressed by [Equation 3](#):

$$V_{\text{HYST}} = \left[ \frac{|V_{\text{REF\_PRE}} - V_{\text{REF\_POST}}|}{V_{\text{REF\_NOM}}} \right] \times 10^6 \text{ (ppm/}^\circ\text{C)} \quad (3)$$

Where:

$V_{\text{HYST}}$  = thermal hysteresis.

$V_{\text{REF\_PRE}}$  = output voltage measured at +25°C pre-temperature cycling.

$V_{\text{REF\_POST}}$  = output voltage measured after the device cycles through the temperature range of –40°C to +120°C, and returns to +25°C.

## DAC NOISE PERFORMANCE

Typical noise performance for the DAC8565 with the internal reference enabled is shown in [Figure 54](#) to [Figure 56](#). Output noise spectral density at the  $V_{\text{OUT}}$  pin versus frequency is depicted in [Figure 54](#) for full-scale, midscale, and zero-scale input codes. The typical noise density for midscale code is  $120\text{nV}/\sqrt{\text{Hz}}$  at 1kHz and  $100\text{nV}/\sqrt{\text{Hz}}$  at 1MHz. High-frequency noise can be improved by filtering the reference noise as shown in [Figure 55](#), where a 4.8µF load capacitor is connected to the  $V_{\text{REFH}}/V_{\text{REFOUT}}$  pin and compared to the no-load condition. Integrated output noise between 0.1Hz and 10Hz is close to  $6\mu\text{V}_{\text{PP}}$  (midscale), as shown in [Figure 56](#).

## BIPOLAR OPERATION USING THE DAC8565

The DAC8565 is designed for single-supply operation, but a bipolar output range is also possible using the circuit in either [Figure 99](#) or [Figure 100](#). The circuit shown gives an output voltage range of  $\pm V_{REF}$ . Rail-to-rail operation at the amplifier output is achievable using an [OPA703](#) as the output amplifier.

The output voltage for any input code can be calculated with [Equation 4](#):

$$V_O = \left[ V_{REF} \times \left( \frac{D}{65536} \right) \times \left( \frac{R_1 + R_2}{R_1} \right) - V_{REF} \times \left( \frac{R_2}{R_1} \right) \right] \quad (4)$$

where  $D$  represents the input code in decimal (0–65535).

With  $V_{REFH} = 5V$ ,  $R_1 = R_2 = 10k\Omega$ .

$$V_O = \left[ \frac{10 \times D}{65536} \right] - 5V \quad (5)$$

This result has an output voltage range of  $\pm 5V$  with 0000h corresponding to a  $-5V$  output and FFFFh corresponding to a  $+5V$  output, as shown in [Figure 99](#). Similarly, using the internal reference, a  $\pm 2.5V$  output voltage range can be achieved, as [Figure 100](#) shows.

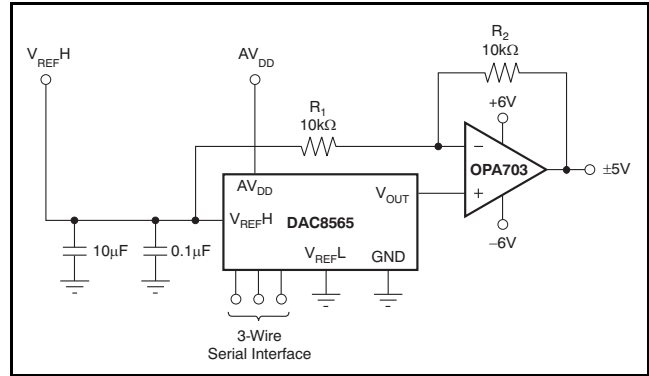

**Figure 99. Bipolar Output Range Using External Reference at 5V**

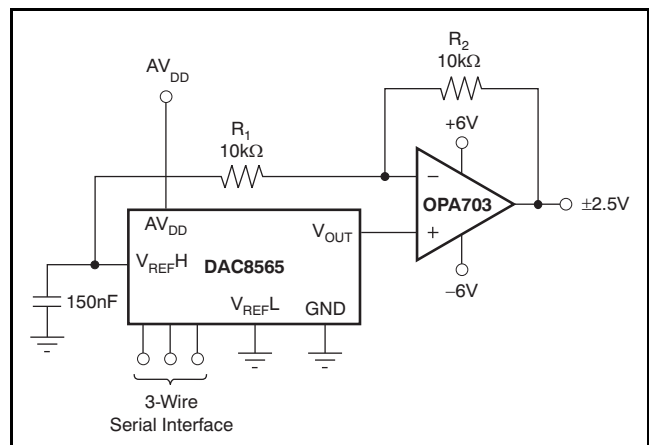

**Figure 100. Bipolar Output Range Using Internal Reference**

## MICROPROCESSOR INTERFACING

### DAC SPI Interfacing

Care must be taken with the digital control signals that are applied directly to the DAC, especially with the  $\overline{\text{SYNC}}$  pin. The  $\overline{\text{SYNC}}$  pin must not be toggled without having a full SCLK pulse in between. If this condition is violated, the SPI interface locks up in an erroneous state, causing the DAC to behave incorrectly and have errors. The DAC can be recovered from this faulty state by writing a valid SPI command or using the  $\overline{\text{SYNC}}$  pin correctly; communication will then be restored. Avoid glitches and transients on the  $\overline{\text{SYNC}}$  line to ensure proper operation.

### DAC8565 to an 8051 Interface

Figure 101 shows a serial interface between the DAC8565 and a typical 8051-type microcontroller. The setup for the interface is as follows: TXD of the 8051 drives SCLK of the DAC8565, while RXD drives the serial data line of the device. The  $\overline{\text{SYNC}}$  signal is derived from a bit-programmable pin on the port of the 8051; in this case, port line P3.3 is used. When data are to be transmitted to the DAC8565, P3.3 is taken low. The 8051 transmits data in 8-bit bytes; thus, only eight falling clock edges occur in the transmit cycle. To load data to the DAC, P3.3 is left low after the first eight bits are transmitted; then, a second write cycle is initiated to transmit the second byte of data. P3.3 is taken high following the completion of the third write cycle. The 8051 outputs the serial data in a format that has the LSB first. The DAC8565 requires its data with the MSB as the first bit received. The 8051 transmit routine must therefore take this requirement into account, and *mirror* the data as needed.

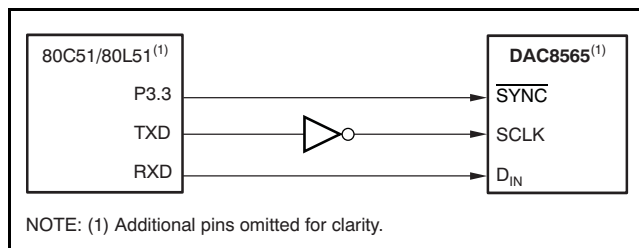

**Figure 101. DAC8565 to 80C51/80L51 Interface**

### DAC8565 to Microwire Interface

Figure 102 shows an interface between the DAC8565 and any Microwire-compatible device. Serial data are shifted out on the falling edge of the serial clock and are clocked into the DAC8565 on the rising edge of the SK signal.

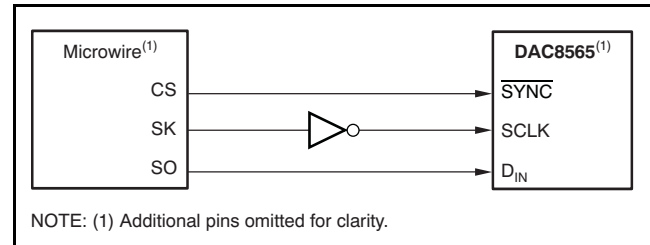

**Figure 102. DAC8565 to Microwire Interface**

### DAC8565 to 68HC11 Interface

Figure 103 shows a serial interface between the DAC8565 and the 68HC11 microcontroller. SCK of the 68HC11 drives the SCLK of the DAC8565, while the MOSI output drives the serial data line of the DAC. The  $\overline{\text{SYNC}}$  signal derives from a port line (PC7), similar to the 8051 diagram.

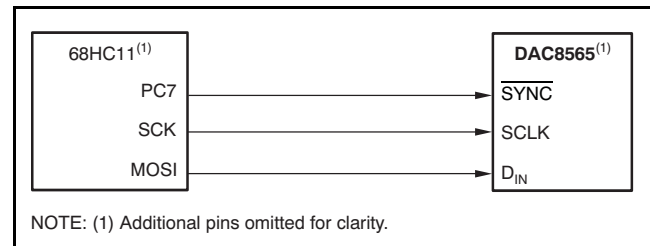

**Figure 103. DAC8565 to 68HC11 Interface**

The 68HC11 should be configured so that its CPOL bit is '0' and its CPHA bit is '1'. This configuration causes data appearing on the MOSI output to be valid on the falling edge of SCK. When data are being transmitted to the DAC, the  $\overline{\text{SYNC}}$  line is held low (PC7). Serial data from the 68HC11 are transmitted in 8-bit bytes with only eight falling clock edges occurring in the transmit cycle. (Data are transmitted MSB first.) In order to load data to the DAC8565, PC7 is left low after the first eight bits are transferred; then, a second and third serial write operation are performed to the DAC. PC7 is taken high at the end of this procedure.

## LAYOUT

A precision analog component requires careful layout, adequate bypassing, and clean, well-regulated power supplies.

The DAC8565 offers single-supply operation, and is often used in close proximity with digital logic, microcontrollers, microprocessors, and digital signal processors. The more digital logic present in the design and the higher the switching speed, the more difficult it is to keep digital noise from appearing at the output.

As a result of the single ground pin of the DAC8565, all return currents (including digital and analog return currents for the DAC) must flow through a single point. Ideally, GND would be connected directly to an analog ground plane. This plane would be separate from the ground connection for the digital components until they were connected at the power-entry point of the system.

The power applied to  $V_{DD}$  should be well-regulated and low noise. Switching power supplies and dc/dc converters often have high-frequency glitches or spikes riding on the output voltage. In addition, digital components can create similar high-frequency spikes as their internal logic switches states. This noise can easily couple into the DAC output voltage through various paths between the power connections and analog output.

As with the GND connection,  $V_{DD}$  should be connected to a power-supply plane or trace that is separate from the connection for digital logic until they are connected at the power-entry point. In addition, a 1 $\mu$ F to 10 $\mu$ F capacitor and 0.1 $\mu$ F bypass capacitor are strongly recommended. In some situations, additional bypassing may be required, such as a 100 $\mu$ F electrolytic capacitor or even a *Pi* filter made up of inductors and capacitors—all designed to essentially low-pass filter the supply and remove the high-frequency noise.

## PARAMETER DEFINITIONS

With the increased complexity of many different specifications listed in product data sheets, this section summarizes selected specifications related to digital-to-analog converters.

### STATIC PERFORMANCE

Static performance parameters are specifications such as differential nonlinearity (DNL) or integral nonlinearity (INL). These are dc specifications and provide information on the accuracy of the DAC. They are most important in applications where the signal changes slowly and accuracy is required.

#### Resolution

Generally, the DAC resolution can be expressed in different forms. Specifications such as IEC 60748-4 recognize the numerical, analog, and relative resolution. The numerical resolution is defined as the number of digits in the chosen numbering system necessary to express the total number of steps of the transfer characteristic, where a step represents both a digital input code and the corresponding discrete analogue output value. The most commonly-used definition of resolution provided in data sheets is the numerical resolution expressed in bits.

#### Least Significant Bit (LSB)

The least significant bit (LSB) is defined as the smallest value in a binary coded system. The value of the LSB can be calculated by dividing the full-scale output voltage by  $2^n$ , where  $n$  is the resolution of the converter.

#### Most Significant Bit (MSB)

The most significant bit (MSB) is defined as the largest value in a binary coded system. The value of the MSB can be calculated by dividing the full-scale output voltage by 2. Its value is one-half of full-scale.

#### Relative Accuracy or Integral Nonlinearity (INL)

Relative accuracy or integral nonlinearity (INL) is defined as the maximum deviation between the real transfer function and a straight line passing through the endpoints of the ideal DAC transfer function. DNL is measured in LSBs.

#### Differential Nonlinearity (DNL)

Differential nonlinearity (DNL) is defined as the maximum deviation of the real LSB step from the ideal 1LSB step. Ideally, any two adjacent digital codes correspond to output analog voltages that are exactly one LSB apart. If the DNL is less than 1LSB, the DAC is said to be monotonic.

#### Full-Scale Error

Full-scale error is defined as the deviation of the real full-scale output voltage from the ideal output voltage while the DAC register is loaded with the full-scale code (0xFFFF). Ideally, the output should be  $V_{DD} - 1$  LSB. The full-scale error is expressed in percent of full-scale range (%FSR).

#### Offset Error

The offset error is defined as the difference between actual output voltage and the ideal output voltage in the linear region of the transfer function. This difference is calculated by using a straight line defined by two codes (code 485 and 64714). Since the offset error is defined by a straight line, it can have a negative or positive value. Offset error is measured in mV.

#### Zero-Code Error

The zero-code error is defined as the DAC output voltage, when all '0's are loaded into the DAC register. Zero-scale error is a measure of the difference between actual output voltage and ideal output voltage (0V). It is expressed in mV. It is primarily caused by offsets in the output amplifier.

#### Gain Error

Gain error is defined as the deviation in the slope of the real DAC transfer characteristic from the ideal transfer function. Gain error is expressed as a percentage of full-scale range (%FSR).

#### Full-Scale Error Drift

Full-scale error drift is defined as the change in full-scale error with a change in temperature. Full-scale error drift is expressed in units of %FSR/°C.

#### Offset Error Drift

Offset error drift is defined as the change in offset error with a change in temperature. Offset error drift is expressed in  $\mu\text{V}/^\circ\text{C}$ .

#### Zero-Code Error Drift

Zero-code error drift is defined as the change in zero-code error with a change in temperature. Zero-code error drift is expressed in  $\mu\text{V}/^\circ\text{C}$ .

#### Gain Temperature Coefficient

The gain temperature coefficient is defined as the change in gain error with changes in temperature. The gain temperature coefficient is expressed in ppm of FSR/°C.

### Power-Supply Rejection Ratio (PSRR)

Power-supply rejection ratio (PSRR) is defined as the ratio of change in output voltage to a change in supply voltage for a full-scale output of the DAC. The PSRR of a device indicates how the output of the DAC is affected by changes in the supply voltage. PSRR is measured in decibels (dB).

### Monotonicity

Monotonicity is defined as a slope whose sign does not change. If a DAC is monotonic, the output changes in the same direction or remains at least constant for each step increase (or decrease) in the input code.

## DYNAMIC PERFORMANCE

Dynamic performance parameters are specifications such as settling time or slew rate, which are important in applications where the signal rapidly changes and/or high frequency signals are present.

### Slew Rate

The output slew-rate (SR) of an amplifier or other electronic circuit is defined as the maximum rate of change of the output voltage for all possible input signals.

$$SR = \max \left( \left| \frac{\Delta V_{OUT}(t)}{\Delta t} \right| \right)$$

Where  $\Delta V_{OUT}(t)$  is the output produced by the amplifier as a function of time  $t$ .

### Output Voltage Settling Time

Settling time is the total time (including slew time) for the DAC output to settle within an error band around its final value after a change in input. Settling times are specified to within  $\pm 0.003\%$  (or whatever value is specified) of full-scale range (FSR).

### Code Change/Digital-to-Analog Glitch Energy

Digital-to-analog glitch impulse is the impulse injected into the analog output when the input code in the DAC register changes state. It is normally specified as the area of the glitch in nanovolts-second (nV-s), and is measured when the digital input code changes by 1LSB at the major carry transition.

### Digital Feedthrough

Digital feedthrough is defined as impulse seen at the output of the DAC from the digital inputs of the DAC. It is measured when the DAC output is not updated. It is specified in nV-s, and measured with a full-scale code change on the data bus; that is, from all '0's to all '1's and vice versa.

### Channel-to-Channel DC Crosstalk

Channel-to-channel dc crosstalk is defined as the dc change in the output level of one DAC channel in response to a change in the output of another DAC channel. It is measured with a full-scale output change on one DAC channel while monitoring another DAC channel remains at midscale. It is expressed in LSB.

### Channel-to-Channel AC Crosstalk

AC crosstalk in a multi-channel DAC is defined as the amount of ac interference experienced on the output of a channel at a frequency ( $f$ ) (and its harmonics), when the output of an adjacent channel changes its value at the rate of frequency ( $f$ ). It is measured with one channel output oscillating with a sine wave of 1kHz frequency, while monitoring the amplitude of 1kHz harmonics on an adjacent DAC channel output (kept at zero scale). It is expressed in dB.

### Signal-to-Noise Ratio (SNR)

Signal-to-noise ratio (SNR) is defined as the ratio of the root mean-squared (RMS) value of the output signal divided by the RMS values of the sum of all other spectral components below one-half the output frequency, not including harmonics or dc. SNR is measured in dB.

### Total Harmonic Distortion (THD)

Total harmonic distortion + noise is defined as the ratio of the RMS values of the harmonics and noise to the value of the fundamental frequency. It is expressed in a percentage of the fundamental frequency amplitude at sampling rate  $f_s$ .

### Spurious-Free Dynamic Range (SFDR)

Spurious-free dynamic range (SFDR) is the usable dynamic range of a DAC before spurious noise interferes or distorts the fundamental signal. SFDR is the measure of the difference in amplitude between the fundamental and the largest harmonically or non-harmonically related spur from dc to the full Nyquist bandwidth (half the DAC sampling rate, or  $f_s/2$ ). A spur is any frequency bin on a spectrum analyzer, or from a Fourier transform, of the analog output of the DAC. SFDR is specified in decibels relative to the carrier (dBc).

### Signal-to-Noise plus Distortion (SINAD)

SINAD includes all the harmonic and outstanding spurious components in the definition of output noise power in addition to quantizing any internal random noise power. SINAD is expressed in dB at a specified input frequency and sampling rate,  $f_s$ .

### DAC Output Noise Density

Output noise density is defined as internally-generated random noise. Random noise is characterized as a spectral density ( $nV/\sqrt{Hz}$ ). It is measured by loading the DAC to midscale and measuring noise at the output.

### DAC Output Noise

DAC output noise is defined as any voltage deviation of DAC output from the desired value (within a particular frequency band). It is measured with a DAC channel kept at midscale while filtering the output voltage within a band of 0.1Hz to 10Hz and measuring its amplitude peaks. It is expressed in terms of peak-to-peak voltage ( $V_{pp}$ ).

### Full-Scale Range (FSR)

Full-scale range (FSR) is the difference between the maximum and minimum analog output values that the DAC is specified to provide; typically, the maximum and minimum values are also specified. For an  $n$ -bit DAC, these values are usually given as the values matching with code 0 and  $2^n$ .

## REVISION HISTORY

NOTE: Page numbers for previous revisions may differ from page numbers in the current version.

Changes from Revision B (March 2008) to Revision C	Page
• Changed Output Voltage parameter min/max values from 2.4995 and 2.5005 to 2.4975 and 2.5025, respectively .....	4
• Changed Initial Accuracy parameter min/max values from –0.02 and 0.02 to –0.1 and 0.1, respectively .....	4
• Changed $t_2$ minimum values from 10 and 20 to 20 and 10, respectively .....	7
• Added missing arrow to <a href="#">Figure 94</a> .....	26
• Added new <i>DAC SPI Interfacing</i> subsection .....	37

**PACKAGING INFORMATION**

Orderable Device	Status (1)	Package Type	Package Drawing	Pins	Package Qty	Eco Plan (2)	Lead/Ball Finish (6)	MSL Peak Temp (3)	Op Temp (°C)	Device Marking (4/5)	Samples
DAC8565IAPW	ACTIVE	TSSOP	PW	16	90	Green (RoHS & no Sb/Br)	CU NIPDAU	Level-1-260C-UNLIM	-40 to 105	DAC 8565	<a href="#">Samples</a>
DAC8565IAPWR	ACTIVE	TSSOP	PW	16	2000	Green (RoHS & no Sb/Br)	CU NIPDAU	Level-1-260C-UNLIM	-40 to 105	DAC 8565	<a href="#">Samples</a>
DAC8565IBPW	ACTIVE	TSSOP	PW	16	90	Green (RoHS & no Sb/Br)	CU NIPDAU	Level-1-260C-UNLIM	-40 to 105	DAC 8565 B	<a href="#">Samples</a>
DAC8565IBPWR	ACTIVE	TSSOP	PW	16	2000	Green (RoHS & no Sb/Br)	CU NIPDAU	Level-1-260C-UNLIM	-40 to 105	DAC 8565 B	<a href="#">Samples</a>
DAC8565IBPWRG4	ACTIVE	TSSOP	PW	16	2000	Green (RoHS & no Sb/Br)	CU NIPDAU	Level-1-260C-UNLIM	-40 to 105	DAC 8565 B	<a href="#">Samples</a>
DAC8565ICPW	ACTIVE	TSSOP	PW	16	90	Green (RoHS & no Sb/Br)	CU NIPDAU	Level-1-260C-UNLIM	-40 to 105	DAC 8565	<a href="#">Samples</a>
DAC8565ICPWR	ACTIVE	TSSOP	PW	16	2000	Green (RoHS & no Sb/Br)	CU NIPDAU	Level-1-260C-UNLIM	-40 to 105	DAC 8565	<a href="#">Samples</a>
DAC8565IDPW	ACTIVE	TSSOP	PW	16	90	Green (RoHS & no Sb/Br)	CU NIPDAU	Level-1-260C-UNLIM	-40 to 105	DAC 8565 D	<a href="#">Samples</a>
DAC8565IDPWR	ACTIVE	TSSOP	PW	16	2000	Green (RoHS & no Sb/Br)	CU NIPDAU	Level-1-260C-UNLIM	-40 to 105	DAC 8565 D	<a href="#">Samples</a>

(1) The marketing status values are defined as follows:

**ACTIVE:** Product device recommended for new designs.

**LIFEBUY:** TI has announced that the device will be discontinued, and a lifetime-buy period is in effect.

**NRND:** Not recommended for new designs. Device is in production to support existing customers, but TI does not recommend using this part in a new design.

**PREVIEW:** Device has been announced but is not in production. Samples may or may not be available.

**OBSOLETE:** TI has discontinued the production of the device.

(2) **RoHS:** TI defines "RoHS" to mean semiconductor products that are compliant with the current EU RoHS requirements for all 10 RoHS substances, including the requirement that RoHS substance do not exceed 0.1% by weight in homogeneous materials. Where designed to be soldered at high temperatures, "RoHS" products are suitable for use in specified lead-free processes. TI may reference these types of products as "Pb-Free".

**RoHS Exempt:** TI defines "RoHS Exempt" to mean products that contain lead but are compliant with EU RoHS pursuant to a specific EU RoHS exemption.

**Green:** TI defines "Green" to mean the content of Chlorine (Cl) and Bromine (Br) based flame retardants meet JS709B low halogen requirements of <=1000ppm threshold. Antimony trioxide based flame retardants must also meet the <=1000ppm threshold requirement.

- (3) MSL, Peak Temp. - The Moisture Sensitivity Level rating according to the JEDEC industry standard classifications, and peak solder temperature.
- (4) There may be additional marking, which relates to the logo, the lot trace code information, or the environmental category on the device.
- (5) Multiple Device Markings will be inside parentheses. Only one Device Marking contained in parentheses and separated by a "~" will appear on a device. If a line is indented then it is a continuation of the previous line and the two combined represent the entire Device Marking for that device.
- (6) Lead/Ball Finish - Orderable Devices may have multiple material finish options. Finish options are separated by a vertical ruled line. Lead/Ball Finish values may wrap to two lines if the finish value exceeds the maximum column width.

**Important Information and Disclaimer:**The information provided on this page represents TI's knowledge and belief as of the date that it is provided. TI bases its knowledge and belief on information provided by third parties, and makes no representation or warranty as to the accuracy of such information. Efforts are underway to better integrate information from third parties. TI has taken and continues to take reasonable steps to provide representative and accurate information but may not have conducted destructive testing or chemical analysis on incoming materials and chemicals. TI and TI suppliers consider certain information to be proprietary, and thus CAS numbers and other limited information may not be available for release.

In no event shall TI's liability arising out of such information exceed the total purchase price of the TI part(s) at issue in this document sold by TI to Customer on an annual basis.

**TAPE AND REEL INFORMATION**

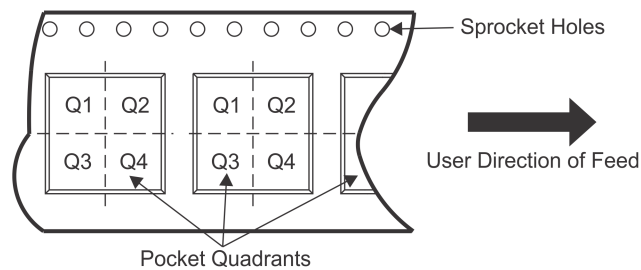
**QUADRANT ASSIGNMENTS FOR PIN 1 ORIENTATION IN TAPE**

\*All dimensions are nominal

Device	Package Type	Package Drawing	Pins	SPQ	Reel Diameter (mm)	Reel Width W1 (mm)	A0 (mm)	B0 (mm)	K0 (mm)	P1 (mm)	W (mm)	Pin1 Quadrant
DAC8565IAPWR	TSSOP	PW	16	2000	330.0	12.4	6.9	5.6	1.6	8.0	12.0	Q1
DAC8565IBPWR	TSSOP	PW	16	2000	330.0	12.4	6.9	5.6	1.6	8.0	12.0	Q1
DAC8565ICPWR	TSSOP	PW	16	2000	330.0	12.4	6.9	5.6	1.6	8.0	12.0	Q1
DAC8565IDPWR	TSSOP	PW	16	2000	330.0	12.4	6.9	5.6	1.6	8.0	12.0	Q1

**TAPE AND REEL BOX DIMENSIONS**

\*All dimensions are nominal

Device	Package Type	Package Drawing	Pins	SPQ	Length (mm)	Width (mm)	Height (mm)
DAC8565IAPWR	TSSOP	PW	16	2000	350.0	350.0	43.0
DAC8565IBPWR	TSSOP	PW	16	2000	350.0	350.0	43.0
DAC8565ICPWR	TSSOP	PW	16	2000	350.0	350.0	43.0
DAC8565IDPWR	TSSOP	PW	16	2000	350.0	350.0	43.0

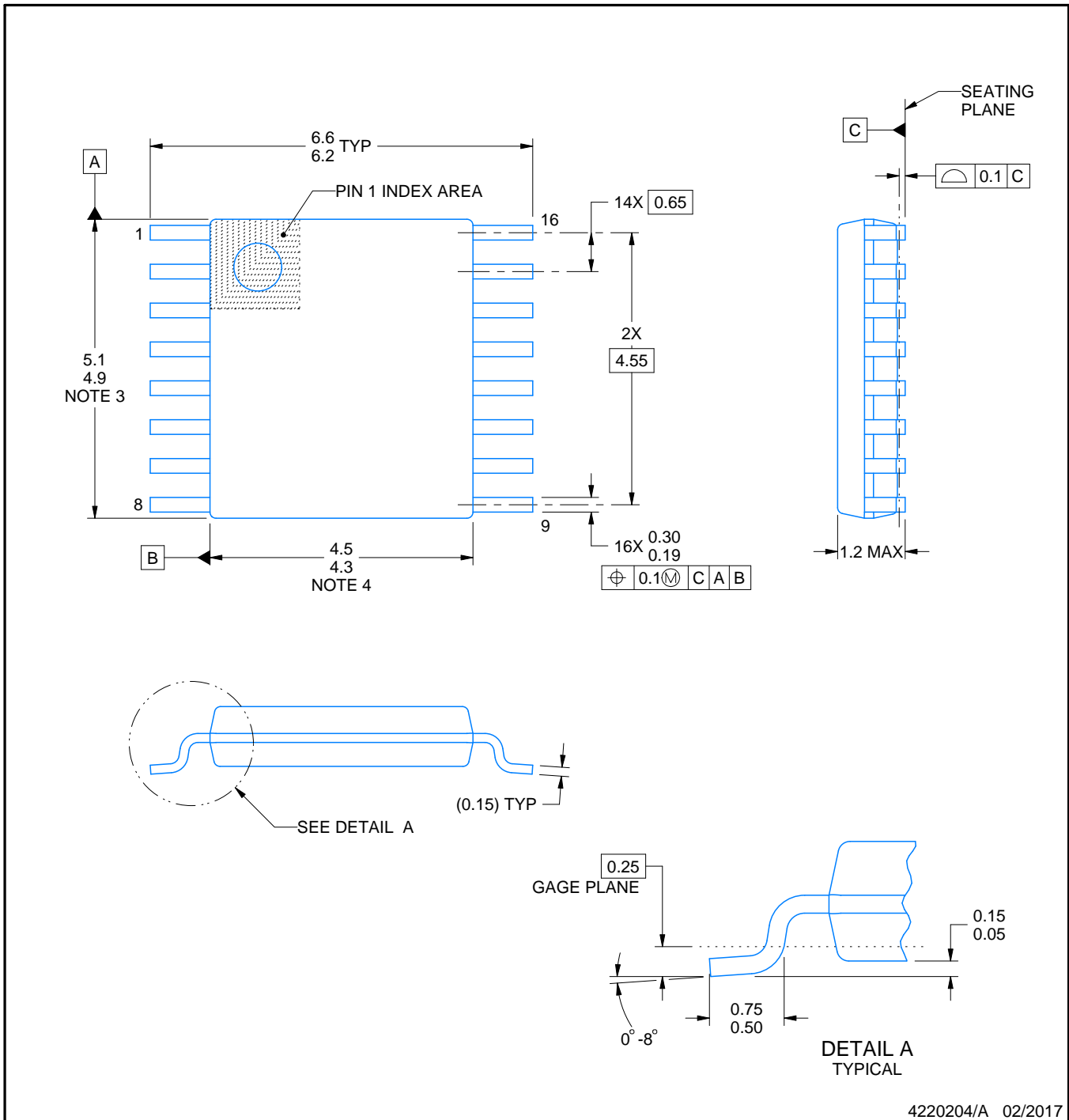

4220204/A 02/2017

**NOTES:**

1. All linear dimensions are in millimeters. Any dimensions in parenthesis are for reference only. Dimensioning and tolerancing per ASME Y14.5M.
2. This drawing is subject to change without notice.
3. This dimension does not include mold flash, protrusions, or gate burrs. Mold flash, protrusions, or gate burrs shall not exceed 0.15 mm per side.
4. This dimension does not include interlead flash. Interlead flash shall not exceed 0.25 mm per side.
5. Reference JEDEC registration MO-153.

# EXAMPLE BOARD LAYOUT

PW0016A

TSSOP - 1.2 mm max height

SMALL OUTLINE PACKAGE



LAND PATTERN EXAMPLE  
EXPOSED METAL SHOWN  
SCALE: 10X



SOLDER MASK DETAILS

4220204/A 02/2017

NOTES: (continued)

- 6. Publication IPC-7351 may have alternate designs.
- 7. Solder mask tolerances between and around signal pads can vary based on board fabrication site.

# EXAMPLE STENCIL DESIGN

PW0016A

TSSOP - 1.2 mm max height

SMALL OUTLINE PACKAGE



SOLDER PASTE EXAMPLE  
BASED ON 0.125 mm THICK STENCIL  
SCALE: 10X

4220204/A 02/2017

NOTES: (continued)

8. Laser cutting apertures with trapezoidal walls and rounded corners may offer better paste release. IPC-7525 may have alternate design recommendations.
9. Board assembly site may have different recommendations for stencil design.

## IMPORTANT NOTICE AND DISCLAIMER

TI PROVIDES TECHNICAL AND RELIABILITY DATA (INCLUDING DATASHEETS), DESIGN RESOURCES (INCLUDING REFERENCE DESIGNS), APPLICATION OR OTHER DESIGN ADVICE, WEB TOOLS, SAFETY INFORMATION, AND OTHER RESOURCES "AS IS" AND WITH ALL FAULTS, AND DISCLAIMS ALL WARRANTIES, EXPRESS AND IMPLIED, INCLUDING WITHOUT LIMITATION ANY IMPLIED WARRANTIES OF MERCHANTABILITY, FITNESS FOR A PARTICULAR PURPOSE OR NON-INFRINGEMENT OF THIRD PARTY INTELLECTUAL PROPERTY RIGHTS.

These resources are intended for skilled developers designing with TI products. You are solely responsible for (1) selecting the appropriate TI products for your application, (2) designing, validating and testing your application, and (3) ensuring your application meets applicable standards, and any other safety, security, or other requirements. These resources are subject to change without notice. TI grants you permission to use these resources only for development of an application that uses the TI products described in the resource. Other reproduction and display of these resources is prohibited. No license is granted to any other TI intellectual property right or to any third party intellectual property right. TI disclaims responsibility for, and you will fully indemnify TI and its representatives against, any claims, damages, costs, losses, and liabilities arising out of your use of these resources.

TI's products are provided subject to TI's Terms of Sale ([www.ti.com/legal/termsofsale.html](http://www.ti.com/legal/termsofsale.html)) or other applicable terms available either on [ti.com](http://ti.com) or provided in conjunction with such TI products. TI's provision of these resources does not expand or otherwise alter TI's applicable warranties or warranty disclaimers for TI products.

Mailing Address: Texas Instruments, Post Office Box 655303, Dallas, Texas 75265  
Copyright © 2019, Texas Instruments Incorporated

## Looking for pricing, stock, or lifecycle information?

Click below to explore more details on WIN SOURCE:

 [View DAC8565IAPW](#) on WIN SOURCE

 [Texas Instruments](#) Information

## Optimize Your Supply Chain with WIN SOURCE Solutions

-  Global Sourcing Solution
-  Obsolete Management
-  Cost Control Management
-  Shortage Management
-  Alternative Solution
-  Excess Inventory Management