



# THE DATASHEET OF DAC7744EB





**DAC7744**



For most current data sheet and other product information, visit [www.burr-brown.com](http://www.burr-brown.com)

## 16-Bit, Quad Voltage Output DIGITAL-TO-ANALOG CONVERTER

### FEATURES

- **LOW POWER: 200mW**
- **UNIPOLAR OR BIPOLAR OPERATION**
- **SINGLE-SUPPLY OUTPUT RANGE: +10V**
- **DUAL SUPPLY OUTPUT RANGE:  $\pm 10V$**
- **SETTLING TIME: 10 $\mu$ s to 0.003%**
- **16-BIT MONOTONICITY:  $-40^{\circ}C$  to  $+85^{\circ}C$**
- **PROGRAMMABLE RESET TO MID-SCALE OR ZERO-SCALE**
- **DATA READBACK**
- **DOUBLE-BUFFERED DATA INPUTS**

### APPLICATIONS

- **PROCESS CONTROL**
- **ATE PIN ELECTRONICS**
- **CLOSED-LOOP SERVO-CONTROL**
- **MOTOR CONTROL**
- **DATA ACQUISITION SYSTEMS**
- **DAC-PER-PIN PROGRAMMERS**

### DESCRIPTION

The DAC7744 is a 16-bit, quad voltage output digital-to-analog converter with guaranteed 16-bit monotonic performance over the specified temperature range. It accepts 16-bit parallel input data, has double-buffered DAC input logic (allowing simultaneous update of all DACs), and provides a readback mode of the internal input registers. Programmable asynchronous reset clears all registers to a mid-scale code of 8000<sub>H</sub> or to a zero-scale of 0000<sub>H</sub>. The DAC7744 operates from either a single +15V supply or from a +15V, -15V, and +5V supply.

Low power and small size per DAC make the DAC7744 ideal for automatic test equipment, DAC-per-pin programmers, data acquisition systems, and closed-loop servo-control. The DAC7744 is available in a 48-lead SSOP package, and offers guaranteed specifications over the  $-40^{\circ}C$  to  $+85^{\circ}C$  temperature range.

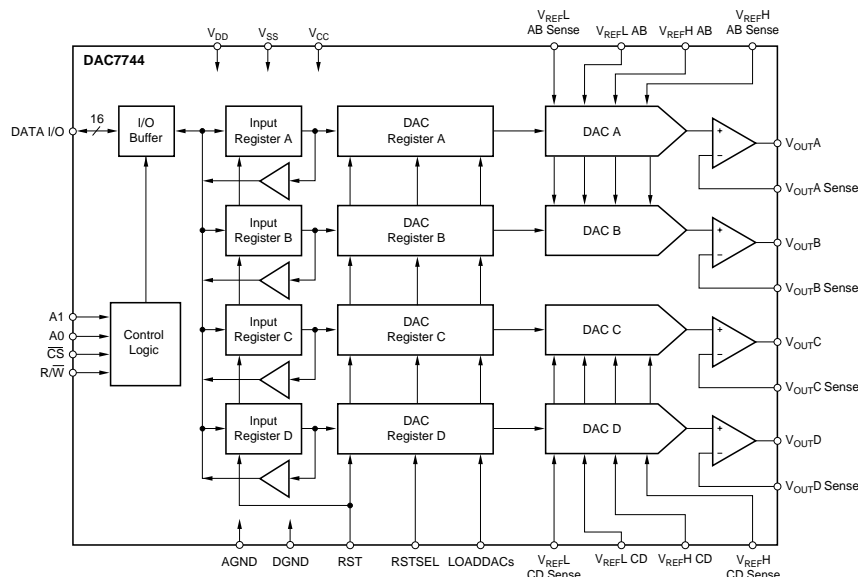

International Airport Industrial Park • Mailing Address: PO Box 11400, Tucson, AZ 85734 • Street Address: 6730 S. Tucson Blvd., Tucson, AZ 85706 • Tel: (520) 746-1111  
 Twx: 910-952-1111 • Internet: <http://www.burr-brown.com/> • Cable: BBRCORP • Telex: 066-6491 • FAX: (520) 889-1510 • Immediate Product Info: (800) 548-6132

# SPECIFICATIONS (Dual Supply)

At  $T_A = T_{MIN}$  to  $T_{MAX}$ ,  $V_{CC} = +15V$ ,  $V_{DD} = +5V$ ,  $V_{SS} = -15V$ ,  $V_{REFH} = +10V$ , and  $V_{REFL} = -10V$ , unless otherwise noted.

PARAMETER	CONDITIONS	DAC7744E			DAC7744EB			DAC7744EC			UNITS
		MIN	TYP	MAX	MIN	TYP	MAX	MIN	TYP	MAX	
<b>ACCURACY</b>											
Linearity Error $T_{MIN}$ to $T_{MAX}$	$T = 25^{\circ}C$			$\pm 3$ $\pm 4$			*			$\pm 2$ $\pm 3$	LSB LSB
Linearity Match			$\pm 4$			*			$\pm 2$		LSB
Differential Linearity Error $T_{MIN}$ to $T_{MAX}$	$T = 25^{\circ}C$			$\pm 3$ $\pm 3$					$\pm 2$ $\pm 2$		LSB LSB
Monotonicity, $T_{MIN}$ to $T_{MAX}$		14			15			16			Bits
Bipolar Zero Error	$T = 25^{\circ}C$		$\pm 0.01$	$\pm 0.025$			*			*	% of FSR
Bipolar Zero Error, $T_{MIN}$ to $T_{MAX}$				$\pm 0.05$			*			*	% of FSR
Full-Scale Error	$T = 25^{\circ}C$			$\pm 0.025$			*			*	% of FSR
Full-Scale Error, $T_{MIN}$ to $T_{MAX}$				$\pm 0.05$			*			*	% of FSR
Bipolar Zero Matching	Channel-to-Channel Matching			$\pm 0.024$			*			*	% of FSR
Full-Scale Matching	Channel-to-Channel Matching			$\pm 0.024$			*			*	% of FSR
Power Supply Rejection Ratio (PSRR)	At Full Scale			25			*			*	ppm/V
<b>ANALOG OUTPUT</b>											
Voltage Output		$V_{REFL}$		$V_{REFH}$	*		*	*		*	V
Output Current		$\pm 5$			*		*	*		*	mA
Maximum Load Capacitance			500			*			*		pF
Short-Circuit Current			$\pm 20$			*			*		mA
Short-Circuit Duration	To $V_{SS}$ , $V_{DD}$ or GND		Indefinite			*			*		
<b>REFERENCE INPUT</b>											
Ref High Input Voltage Range		$V_{REFL} + 1.25$		+10	*		*	*		*	V
Ref Low Input Voltage Range		-10		$V_{REFH} - 1.25$	*		*	*		*	V
Ref High Input Current		-0.3		2.6		*			*		mA
Ref Low Input Current		-3.2		-0.3		*			*		mA
<b>DYNAMIC PERFORMANCE</b>											
Settling Time	To $\pm 0.003\%$ , 20V Output Step See Figure 5		9	11		*	*		*	*	$\mu s$
Channel-to-Channel Crosstalk			0.5			*			*		LSB
Digital Feedthrough			2			*			*		nV-s
Output Noise Voltage	$f = 10kHz$		60			*			*		$nV/\sqrt{Hz}$
<b>DIGITAL INPUT</b>											
$V_{IH}$		$0.7 \cdot V_{DD}$		$V_{DD}$	*			*			V
$V_{IL}$		0		$0.3 \cdot V_{DD}$			*				V
$I_{IH}$				$\pm 10$			*				$\mu A$
$I_{IL}$				$\pm 10$			*				$\mu A$
<b>DIGITAL OUTPUT</b>											
$V_{OH}$	$I_{OH} = -0.8mA$	3.6	4.5		*	*		*	*		V
$V_{OL}$	$I_{OL} = 1.6mA$		0.3	0.4		*	*		*		V
<b>POWER SUPPLY</b>											
$V_{DD}$		+4.75	+5.0	+5.25	*	*	*	*	*	*	V
$V_{CC}$		+14.25	+15.0	+15.75	*	*	*	*	*	*	V
$V_{SS}$		-14.25	-15.0	-15.75	*	*	*	*	*	*	V
$I_{DD}$			50			*			*		$\mu A$
$I_{CC}$			6			*			*		mA
$I_{SS}$			-5			*			*		mA
Power			170	200		*			*		mW
<b>TEMPERATURE RANGE</b>											
Specified Performance		-40		+85	*		*	*		*	$^{\circ}C$

\* Specifications same as grade to the left.

The information provided herein is believed to be reliable; however, BURR-BROWN assumes no responsibility for inaccuracies or omissions. BURR-BROWN assumes no responsibility for the use of this information, and all use of such information shall be entirely at the user's own risk. Prices and specifications are subject to change without notice. No patent rights or licenses to any of the circuits described herein are implied or granted to any third party. BURR-BROWN does not authorize or warrant any BURR-BROWN product for use in life support devices and/or systems.

# SPECIFICATIONS (Single Supply)

At  $T_A = T_{MIN}$  to  $T_{MAX}$ ,  $V_{CC} = +15V$ ,  $V_{DD} = +5V$ ,  $V_{SS} = GND$ ,  $V_{REFH} = +10V$ , and  $V_{REFL} = +50mV$ , unless otherwise noted.

PARAMETER	CONDITIONS	DAC7744E			DAC7744EB			DAC7744EC			UNITS
		MIN	TYP	MAX	MIN	TYP	MAX	MIN	TYP	MAX	
<b>ACCURACY</b>											
Linearity Error <sup>(1)</sup> $T_{MIN}$ to $T_{MAX}$	$T = 25^{\circ}C$			$\pm 3$ $\pm 4$			*			$\pm 2$ $\pm 3$	LSB LSB
Linearity Match			$\pm 4$			*			$\pm 2$		LSB
Differential Linearity Error $T_{MIN}$ to $T_{MAX}$	$T = 25^{\circ}C$			$\pm 3$ $\pm 3$			$\pm 2$ $\pm 2$			$\pm 1$ $\pm 1$	LSB LSB
Monotonicity, $T_{MIN}$ to $T_{MAX}$	$T = 25^{\circ}C$	14	$\pm 0.01$	$\pm 0.025$	15		*			*	Bits
Unipolar Zero	$T = 25^{\circ}C$			$\pm 0.05$			*			*	% of FSR
Unipolar Zero Error, $T_{MIN}$ to $T_{MAX}$				$\pm 0.025$			*			*	% of FSR
Full-Scale Error	$T = 25^{\circ}C$			$\pm 0.025$			*			*	% of FSR
Full-Scale Error, $T_{MIN}$ to $T_{MAX}$				$\pm 0.05$			*			*	% of FSR
Unipolar Zero Matching	Channel-to-Channel Matching			$\pm 0.024$			*			*	% of FSR
Full-Scale Matching	Channel-to-Channel Matching			$\pm 0.024$			*			*	% of FSR
Power Supply Rejection Ratio (PSRR)	At Full Scale			25			*			*	ppm/V
<b>ANALOG OUTPUT</b>											
Voltage Output	$V_{REFL} = 0V$ , $V_{SS} = 0V$ $R = 10k\Omega$	0		$V_{REFH}$	*		*	*		*	V
Output Current		$\pm 5$			*			*		*	mA
Maximum Load Capacitance			500			*		*	*	*	pF
Short-Circuit Current			$\pm 20$			*		*	*	*	mA
Short-Circuit Duration	To $V_{SS}$ , $V_{CC}$ or GND		Indefinite			*		*	*	*	
<b>REFERENCE INPUT</b>											
Ref High Input Voltage Range		$V_{REFL} + 1.25$		+10	*		*	*		*	V
Ref Low Input Voltage Range		0		$V_{REFH} - 1.25$	*		*	*		*	V
Ref High Input Current		-0.3		1.0		*		*	*	*	mA
Ref Low Input Current		-1.5		-0.3		*		*	*	*	mA
<b>DYNAMIC PERFORMANCE</b>											
Settling Time	To $\pm 0.003\%$ , 10V Output Step See Figure 6		8	10		*	*		*	*	$\mu s$
Channel-to-Channel Crosstalk			0.5			*			*	*	LSB
Digital Feedthrough			2			*			*	*	nV-s
Output Noise Voltage	$f = 10kHz$		60			*			*	*	$nV/\sqrt{Hz}$
<b>DIGITAL INPUT</b>											
$V_{IH}$		$0.7 \cdot V_{DD}$		$V_{DD}$	*			*		*	V
$V_{IL}$		0		$0.3 \cdot V_{DD}$			*		*	*	V
$I_{IH}$				$\pm 10$			*		*	*	$\mu A$
$I_{IL}$				$\pm 10$			*		*	*	$\mu A$
<b>DIGITAL OUTPUT</b>											
$V_{OH}$	$I_{OH} = -0.8mA$	3.6	4.5		*	*		*	*	*	V
$V_{OL}$	$I_{OL} = 1.6mA$		0.3	0.4		*	*		*	*	V
<b>POWER SUPPLY</b>											
$V_{DD}$		+4.75	+5.0	+5.25	*	*	*	*	*	*	V
$V_{CC}$		+14.25	+15.0	+15.75	*	*	*	*	*	*	V
$V_{SS}$			0			*		*	*	*	V
$I_{DD}$			50			*		*	*	*	$\mu A$
$I_{CC}$			3.5			*		*	*	*	mA
Power			50	70		*		*	*	*	mW
<b>TEMPERATURE RANGE</b>											
Specified Performance		-40		+85	*		*	*		*	$^{\circ}C$

\* Specifications same as grade to the left.

NOTE: (1) If  $V_{SS} = 0V$ , the specification applies at code 0021<sub>H</sub> and above, due to possible negative zero scale error.

## ABSOLUTE MAXIMUM RATINGS<sup>(1)</sup>

$V_{CC}$ to $V_{SS}$ .....	-0.3V to +32V
$V_{CC}$ to AGND .....	-0.3V to +16V
$V_{SS}$ to AGND .....	+0.3V to -16V
AGND to DGND .....	-0.3V to +0.3V
$V_{REFH}$ to AGND .....	-9V to +11V
$V_{REFL}$ to AGND .....	-11V to +9V
$V_{DD}$ to GND .....	-0.3V to +6V
$V_{REFH}$ to $V_{REFL}$ .....	-1V to 22V
Digital Input Voltage to GND .....	-0.3V to $V_{DD} + 0.3V$
Digital Output Voltage to GND .....	-0.3V to $V_{DD} + 0.3V$
Maximum Junction Temperature .....	+150°C
Operating Temperature Range .....	-40°C to +85°C
Storage Temperature Range .....	-65°C to +150°C
Lead Temperature (soldering, 10s) .....	+300°C

NOTE: (1) Stresses above those listed under "Absolute Maximum Ratings" may cause permanent damage to the device. Exposure to absolute maximum conditions for extended periods may affect device reliability.



## ELECTROSTATIC DISCHARGE SENSITIVITY

This integrated circuit can be damaged by ESD. Burr-Brown recommends that all integrated circuits be handled with appropriate precautions. Failure to observe proper handling and installation procedures can cause damage.

ESD damage can range from subtle performance degradation to complete device failure. Precision integrated circuits may be more susceptible to damage because very small parametric changes could cause the device not to meet its published specifications.

## PACKAGE/ORDERING INFORMATION

PRODUCT	LINEARITY ERROR (LSB)	DIFFERENTIAL NONLINEARITY (LSB)	PACKAGE	PACKAGE DRAWING NUMBER	SPECIFICATION TEMPERATURE RANGE	ORDERING NUMBER <sup>(1)</sup>	TRANSPORT MEDIA
DAC7744E	±4	±3	48-Lead SSOP	333	-40°C to +85°C	DAC7744E	Rails
"	"	"	"	"	"	DAC7744E/1K	Tape and Reel
DAC7744EB	±4	±2	48-Lead SSOP	333	-40°C to +85°C	DAC7744EB	Rails
"	"	"	"	"	"	DAC7744EB/1K	Tape and Reel
DAC7744EC	±3	±1	48-Lead SSOP	333	-40°C to +85°C	DAC7744EC	Rails
"	"	"	"	"	"	DAC7744EC/1K	Tape and Reel

NOTE: (1) Models with a slash (/) are available only in Tape and Reel in the quantities indicated (e.g., /1K indicates 1000 devices per reel). Ordering 1000 pieces of "DAC7744E/1K" will get a single 1000-piece Tape and Reel.

## ESD PROTECTION CIRCUITS

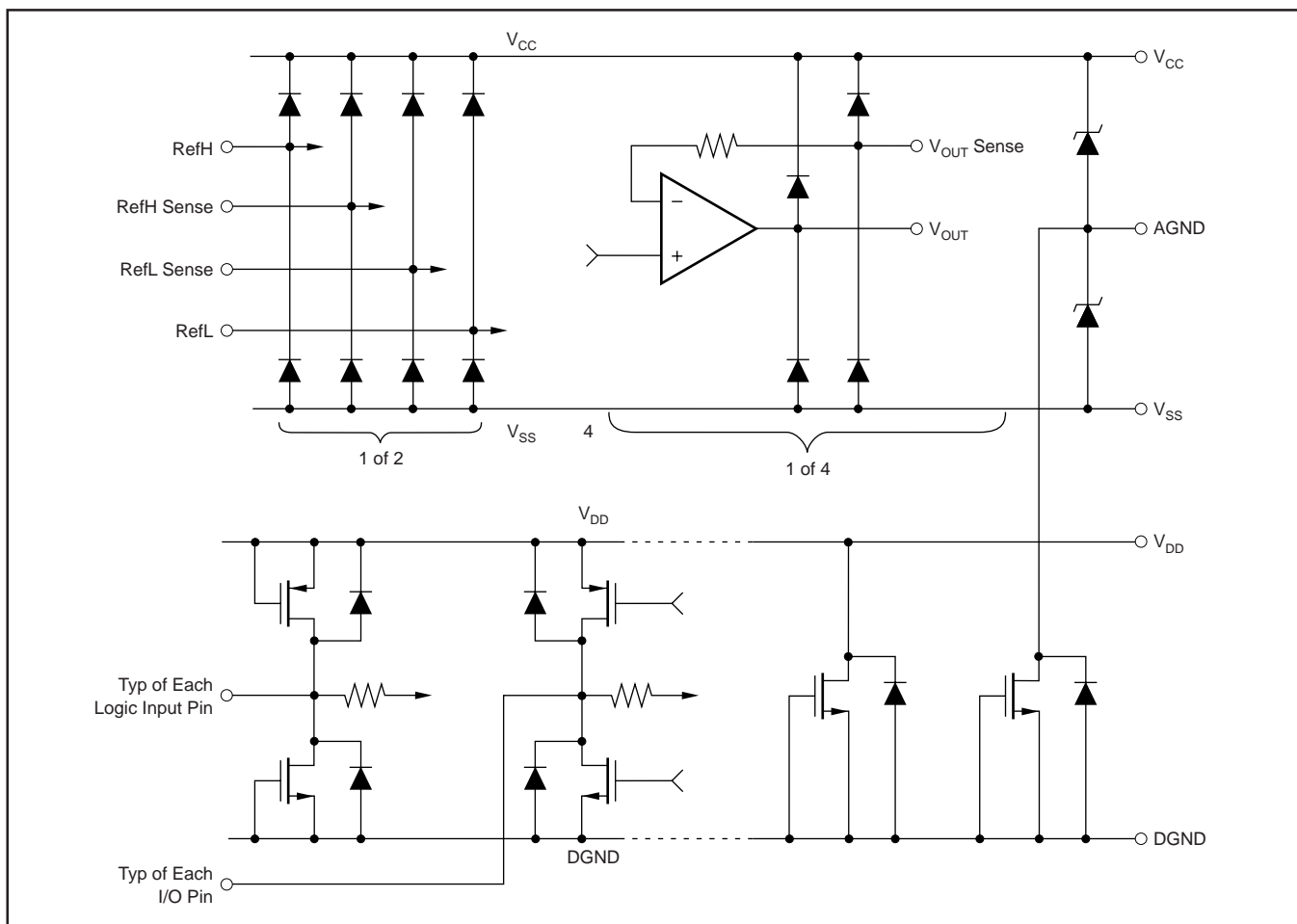



# TYPICAL PERFORMANCE CURVES: $V_{SS} = 0V$

At  $T_A = +25^\circ C$ ,  $V_{DD} = +5V$ ,  $V_{CC} = +15V$ ,  $V_{SS} = 0$ ,  $V_{REFH} = +10V$ , and  $V_{REFL} = 0V$ , representative unit, unless otherwise specified.

## +25°C

LINEARITY ERROR AND  
DIFFERENTIAL LINEARITY ERROR vs CODE  
(DAC A, +25°C)

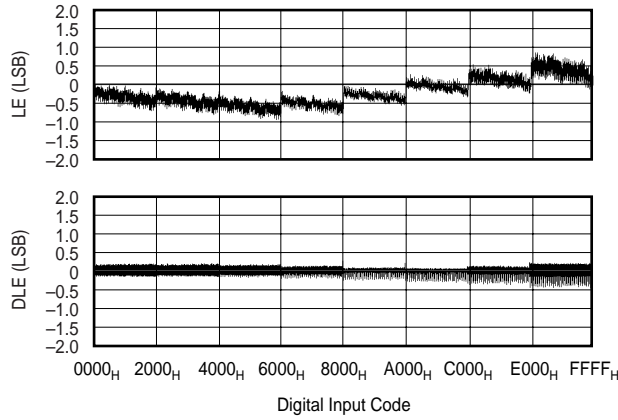

LINEARITY ERROR AND  
DIFFERENTIAL LINEARITY ERROR vs CODE  
(DAC B, +25°C)

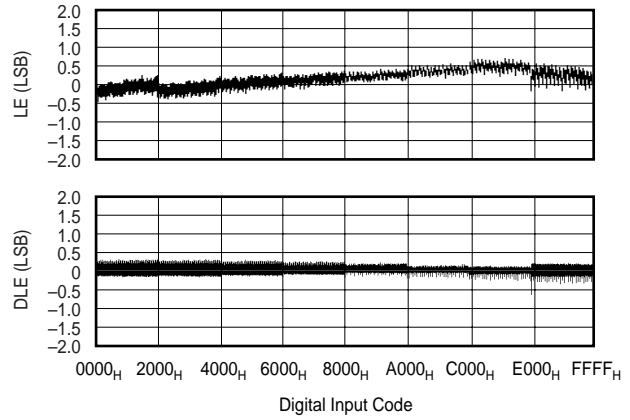

LINEARITY ERROR AND  
DIFFERENTIAL LINEARITY ERROR vs CODE  
(DAC C, +25°C)

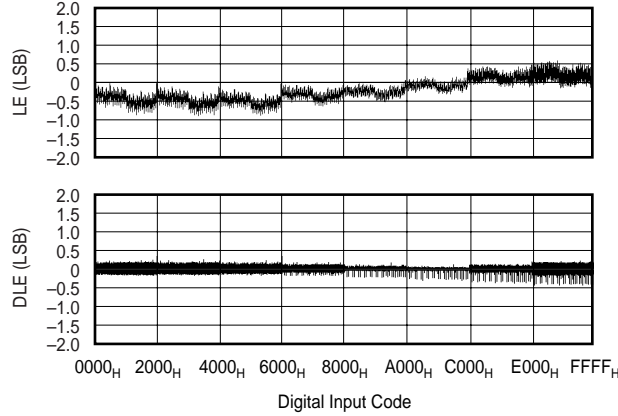

LINEARITY ERROR AND  
DIFFERENTIAL LINEARITY ERROR vs CODE  
(DAC D, +25°C)

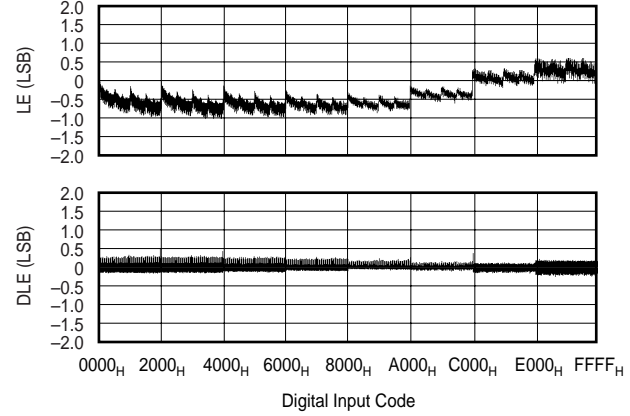

## +85°C

LINEARITY ERROR AND  
DIFFERENTIAL LINEARITY ERROR vs CODE  
(DAC A, +85°C)

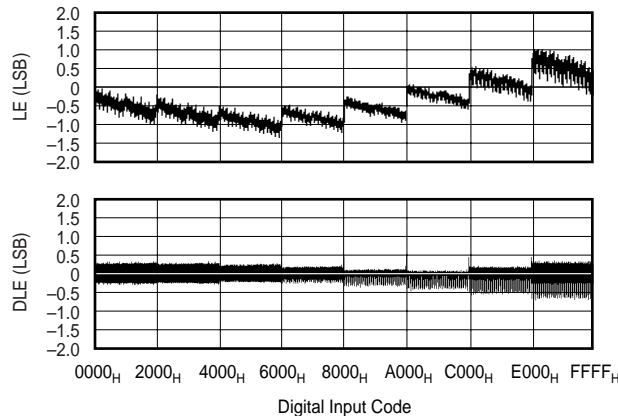

LINEARITY ERROR AND  
DIFFERENTIAL LINEARITY ERROR vs CODE  
(DAC B, +85°C)

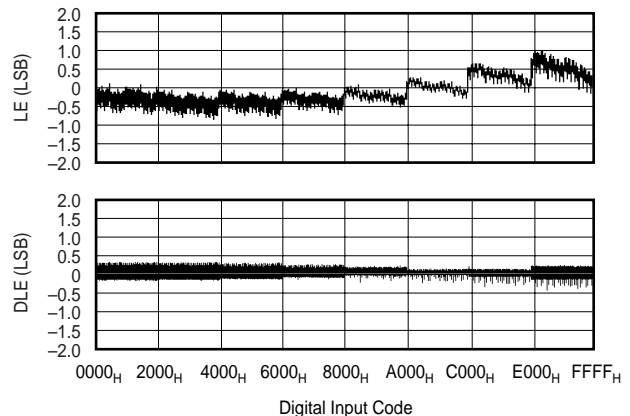

# TYPICAL PERFORMANCE CURVES: $V_{SS} = 0V$ (Cont.)

At  $T_A = +25^\circ C$ ,  $V_{DD} = +5V$ ,  $V_{CC} = +15V$ ,  $V_{SS} = 0$ ,  $V_{REFH} = +10V$ , and  $V_{REFL} = 0V$ , representative unit, unless otherwise specified.

**+85°C (cont.)**

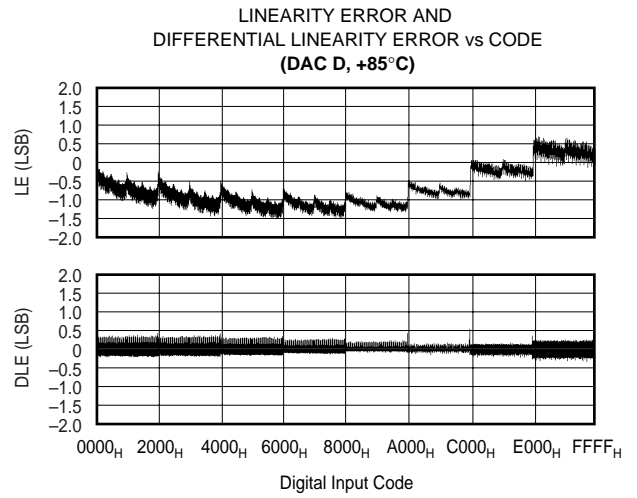
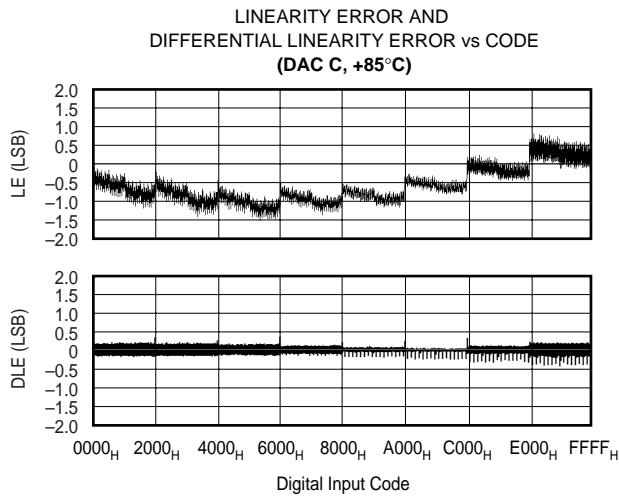

**-40°C**

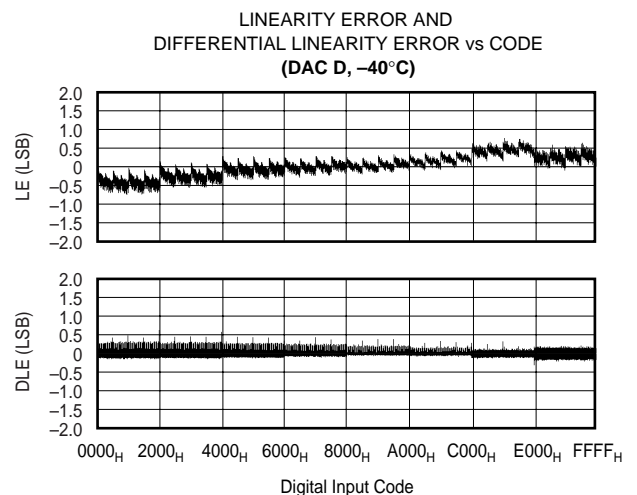
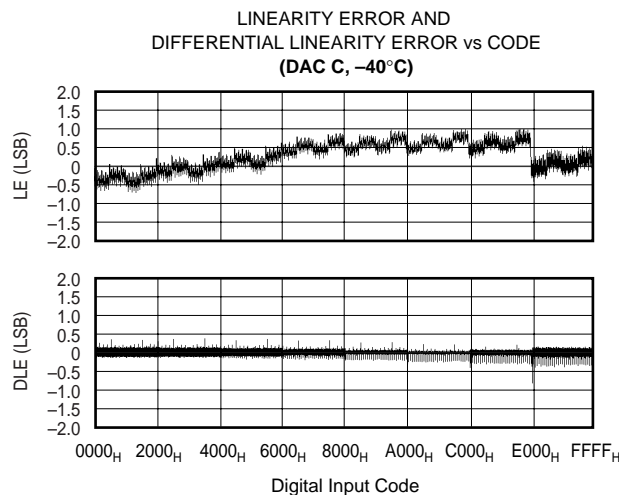
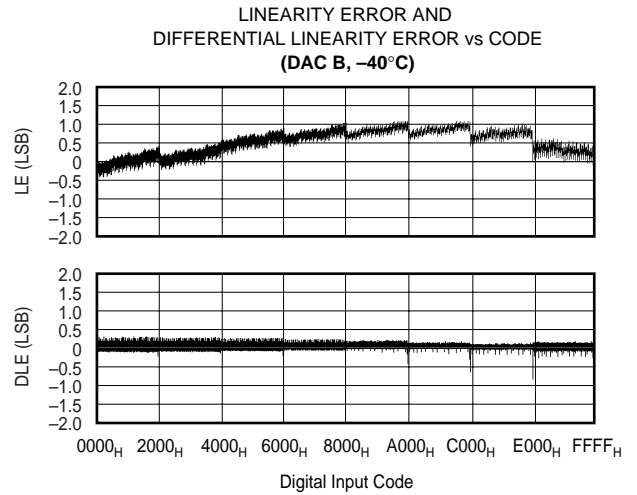
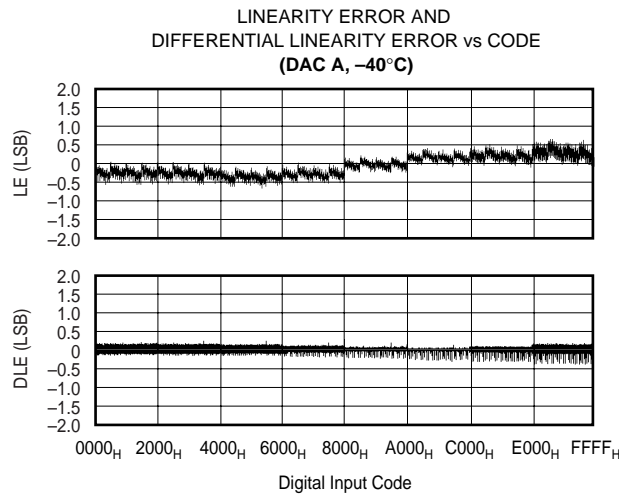

# TYPICAL PERFORMANCE CURVES: $V_{SS} = 0V$ (Cont.)

At  $T_A = +25^\circ C$ ,  $V_{DD} = +5V$ ,  $V_{CC} = +15V$ ,  $V_{SS} = 0$ ,  $V_{REFH} = +10V$ , and  $V_{REFL} = 0V$ , representative unit, unless otherwise specified.

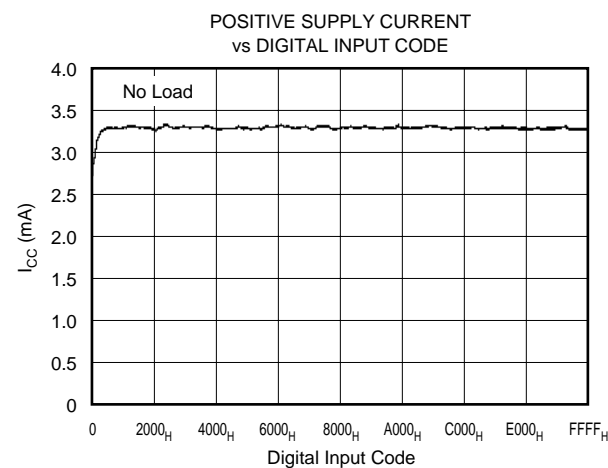
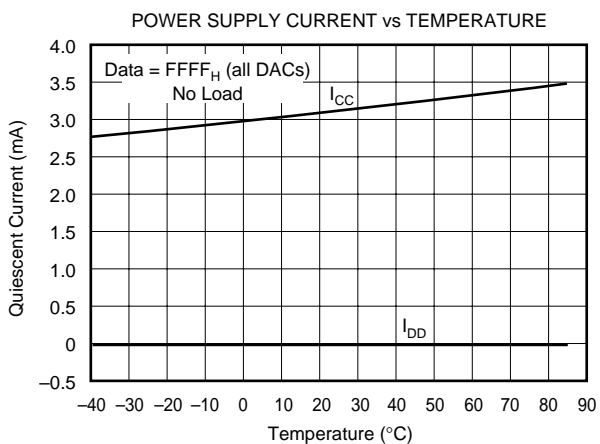
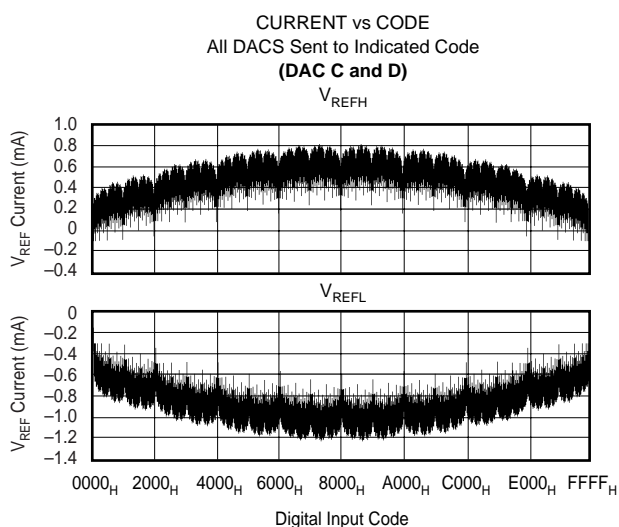
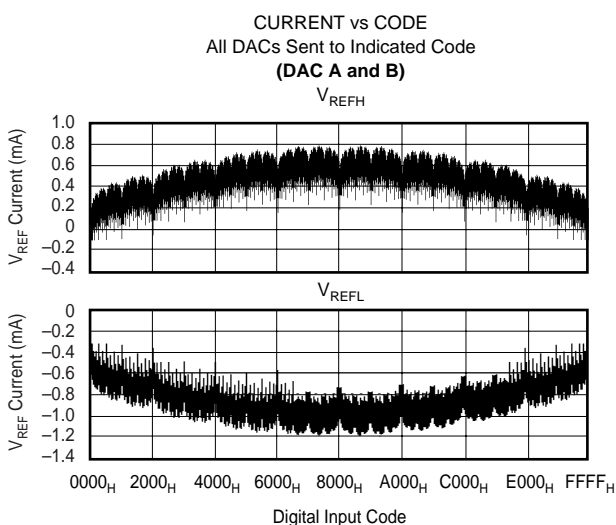
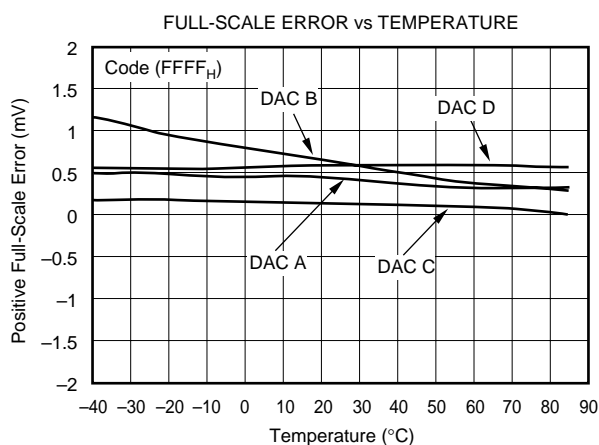
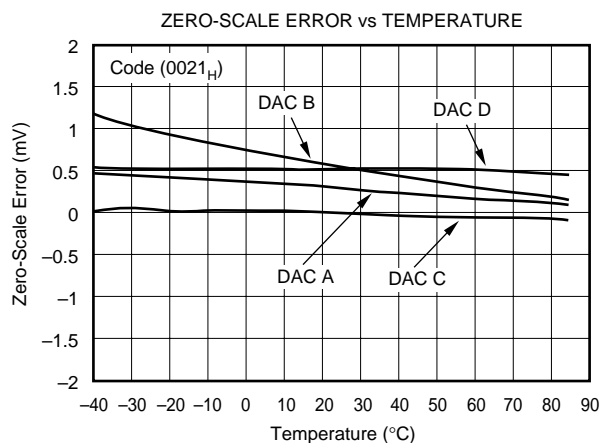

# TYPICAL PERFORMANCE CURVES: $V_{SS} = 0V$ (Cont.)

At  $T_A = +25^\circ C$ ,  $V_{DD} = +5V$ ,  $V_{CC} = +15V$ ,  $V_{SS} = 0$ ,  $V_{REFH} = +10V$ , and  $V_{REFL} = 0V$ , representative unit, unless otherwise specified.

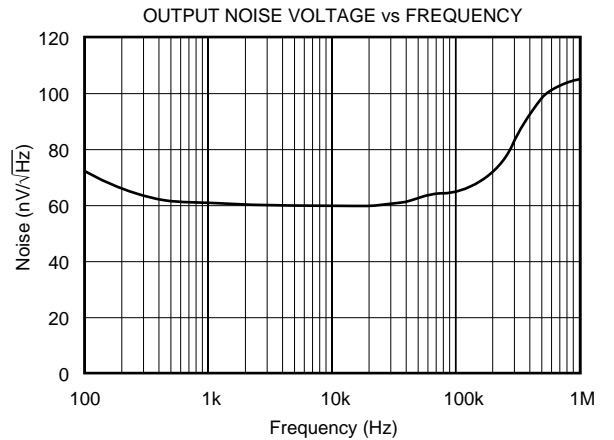
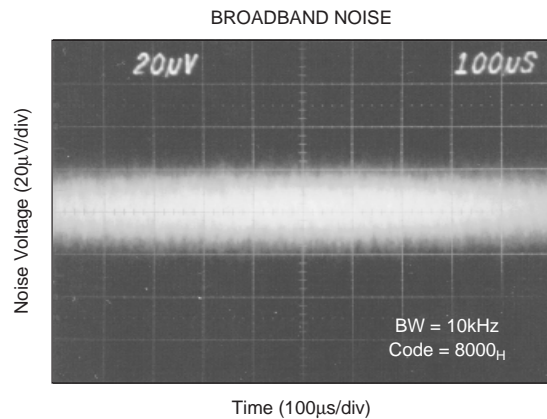
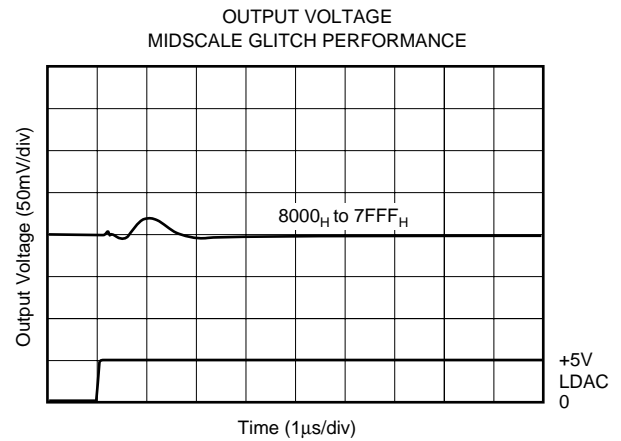
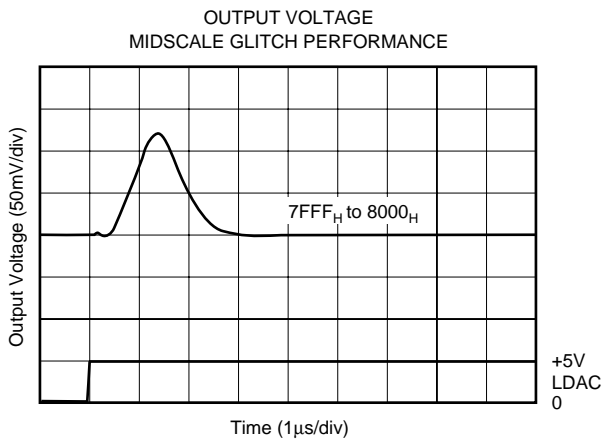
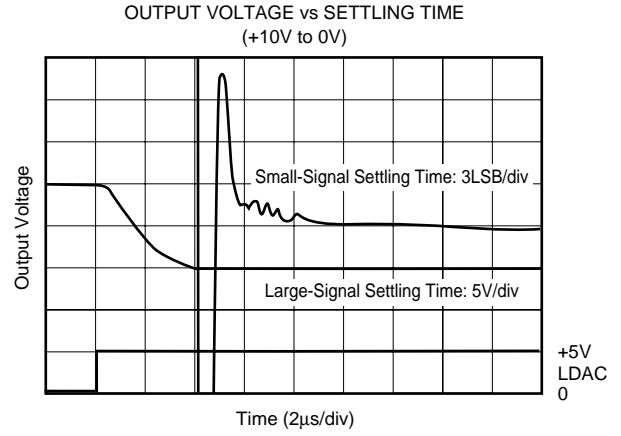
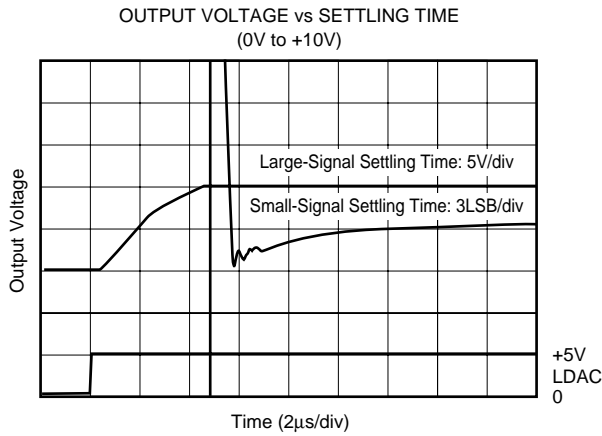

# TYPICAL PERFORMANCE CURVES: $V_{SS} = 0V$ (Cont.)

At  $T_A = +25^\circ C$ ,  $V_{DD} = +5V$ ,  $V_{CC} = +15V$ ,  $V_{SS} = 0$ ,  $V_{REFH} = +10V$ , and  $V_{REFL} = 0V$ , representative unit, unless otherwise specified.

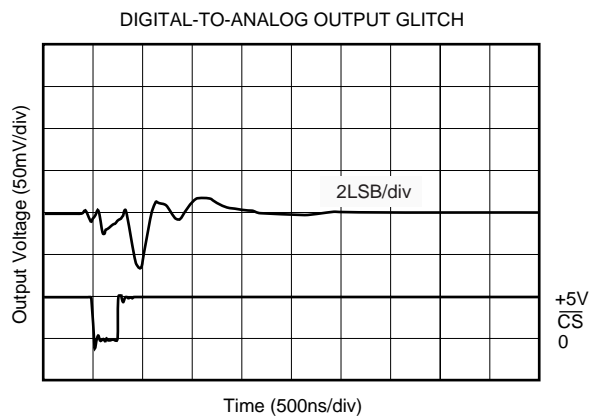
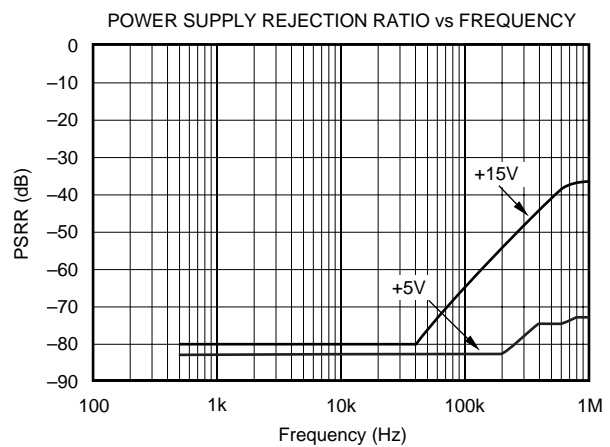
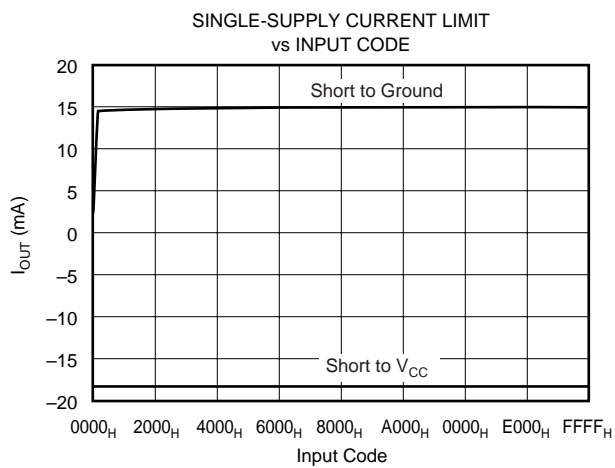
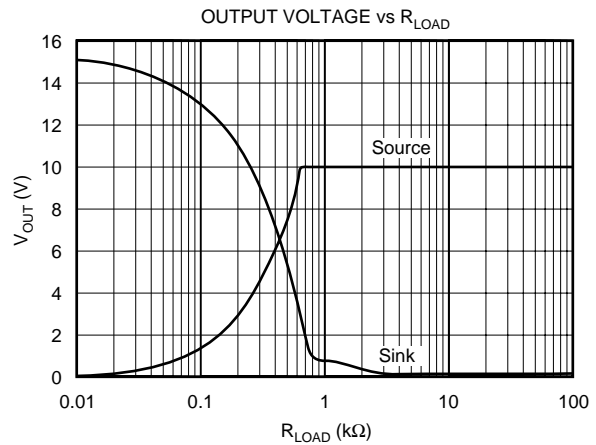
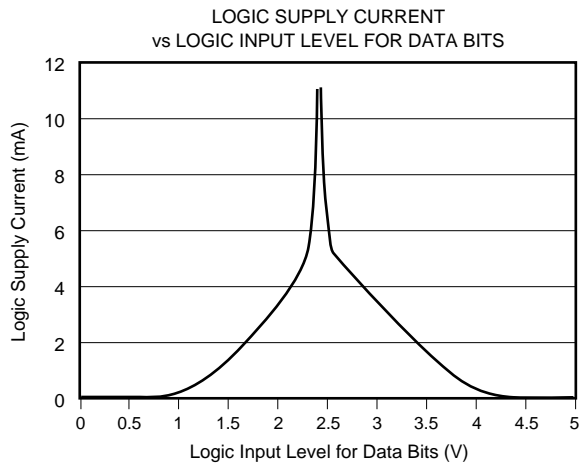

# TYPICAL PERFORMANCE CURVES: $V_{SS} = -15V$

At  $T_A = +25^\circ C$ ,  $V_{DD} = +5V$ ,  $V_{CC} = +15V$ ,  $V_{SS} = -15V$ ,  $V_{REFH} = +10V$ , and  $V_{REFL} = -10V$ , representative unit, unless otherwise specified.

## +25°C

LINEARITY ERROR AND  
DIFFERENTIAL LINEARITY ERROR vs CODE  
(DAC A, +25°C)

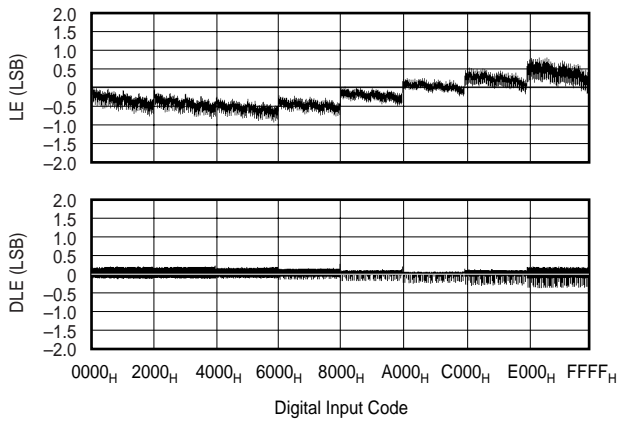

LINEARITY ERROR AND  
DIFFERENTIAL LINEARITY ERROR vs CODE  
(DAC B, +25°C)

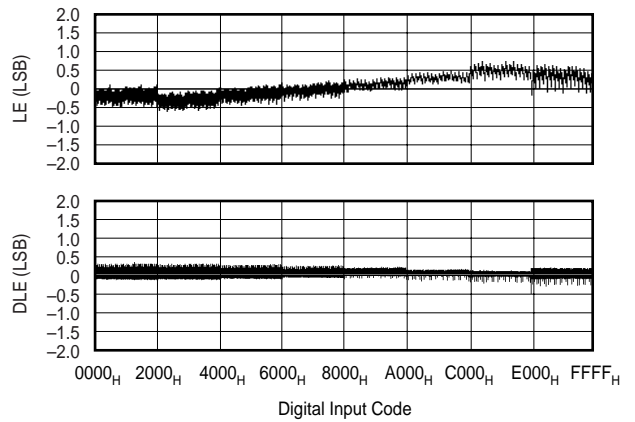

LINEARITY ERROR AND  
DIFFERENTIAL LINEARITY ERROR vs CODE  
(DAC C, +25°C)

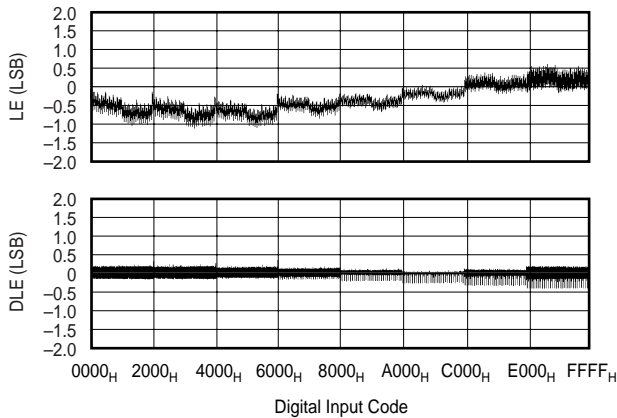

LINEARITY ERROR AND  
DIFFERENTIAL LINEARITY ERROR vs CODE  
(DAC D, +25°C)

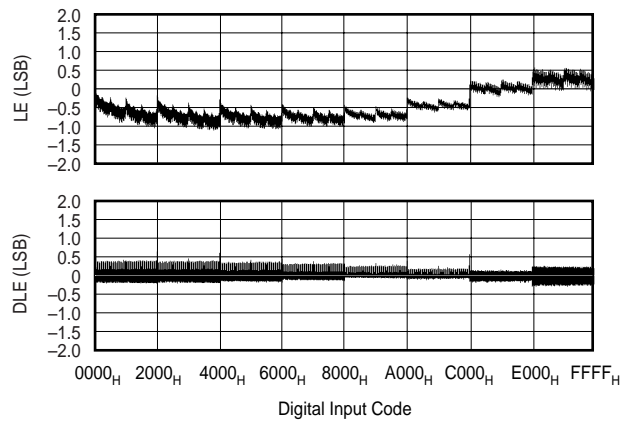

## +85°C

LINEARITY ERROR AND  
DIFFERENTIAL LINEARITY ERROR vs CODE  
(DAC A, +85°C)

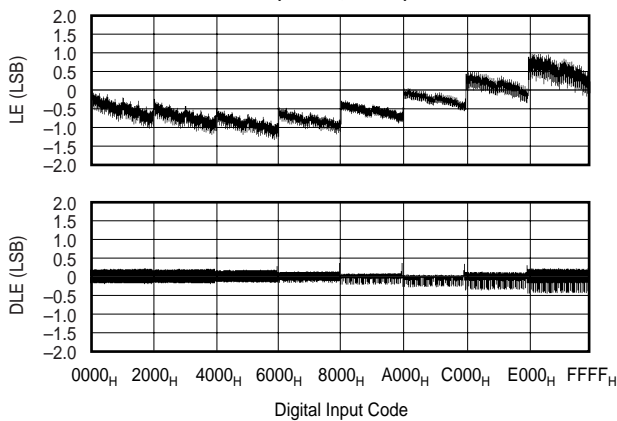

LINEARITY ERROR AND  
DIFFERENTIAL LINEARITY ERROR vs CODE  
(DAC B, +85°C)

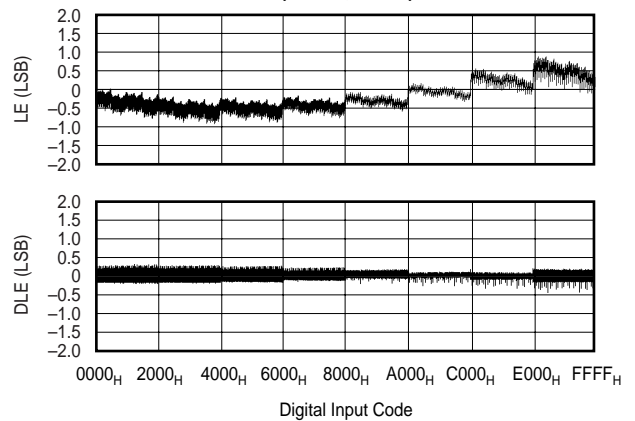

# TYPICAL PERFORMANCE CURVES: $V_{SS} = -15V$ (Cont.)

At  $T_A = +25^\circ C$ ,  $V_{DD} = +5V$ ,  $V_{CC} = +15V$ ,  $V_{SS} = -15V$ ,  $V_{REFH} = +10V$ , and  $V_{REFL} = -10V$ , representative unit, unless otherwise specified.

## +85°C (cont.)

LINEARITY ERROR AND  
DIFFERENTIAL LINEARITY ERROR vs CODE  
(DAC C, +85°C)

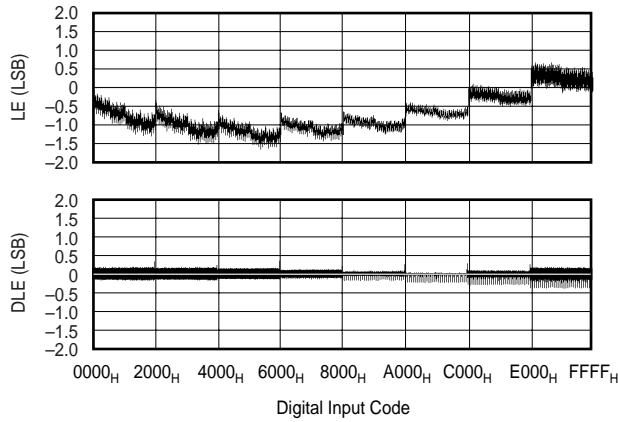

LINEARITY ERROR AND  
DIFFERENTIAL LINEARITY ERROR vs CODE  
(DAC D, +85°C)

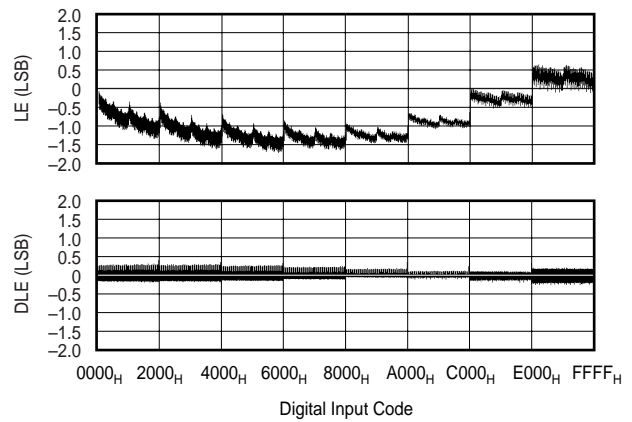

## -40°C

LINEARITY ERROR AND  
DIFFERENTIAL LINEARITY ERROR vs CODE  
(DAC A, -40°C)

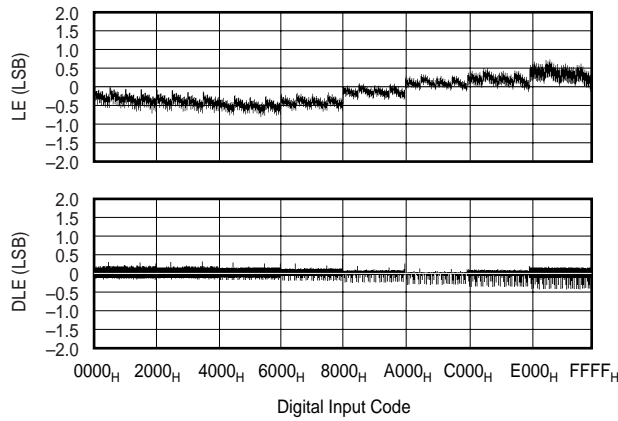

LINEARITY ERROR AND  
DIFFERENTIAL LINEARITY ERROR vs CODE  
(DAC B, -40°C)

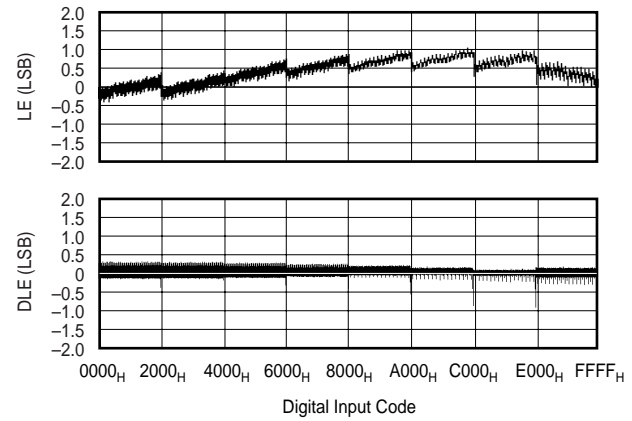

LINEARITY ERROR AND  
DIFFERENTIAL LINEARITY ERROR vs CODE  
(DAC C, -40°C)

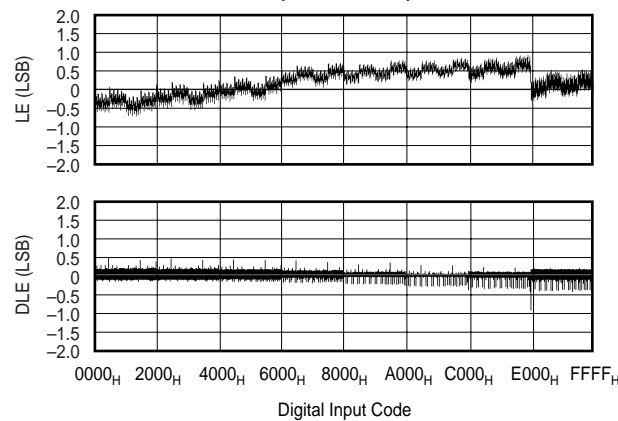

LINEARITY ERROR AND  
DIFFERENTIAL LINEARITY ERROR vs CODE  
(DAC D, -40°C)

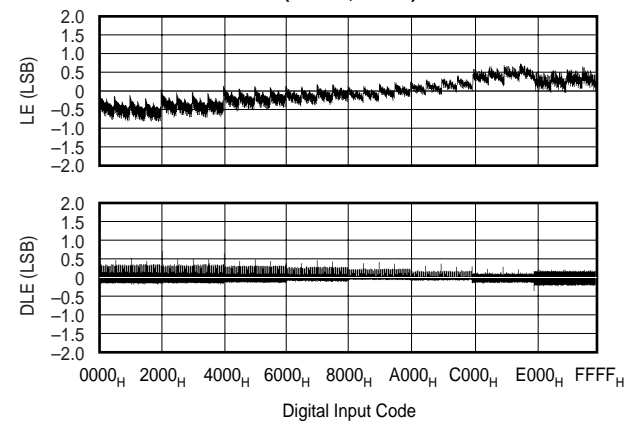

# TYPICAL PERFORMANCE CURVES: $V_{SS} = -15V$ (Cont.)

At  $T_A = +25^\circ C$ ,  $V_{DD} = +5V$ ,  $V_{CC} = +15V$ ,  $V_{SS} = -15V$ ,  $V_{REFH} = +10V$ , and  $V_{REFL} = -10V$ , representative unit, unless otherwise specified.

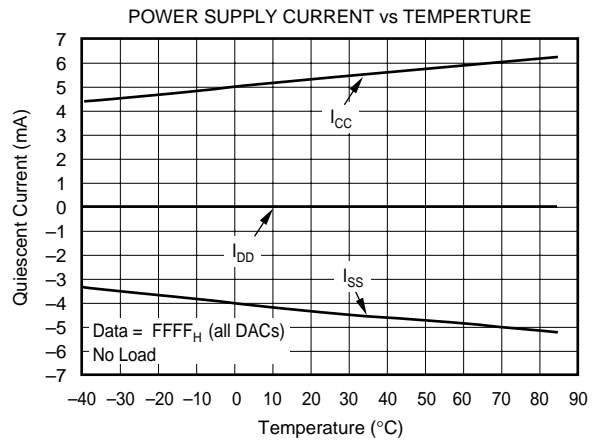
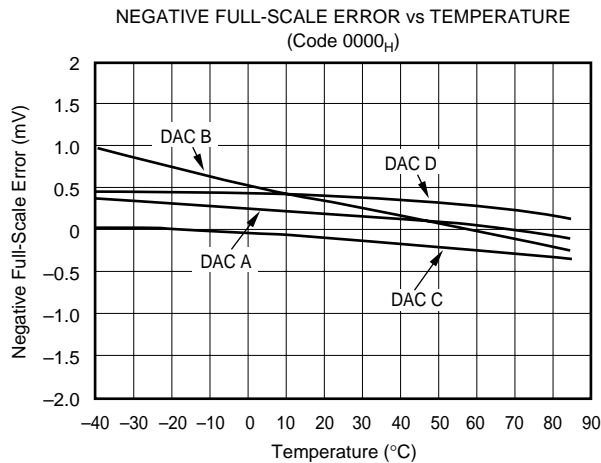
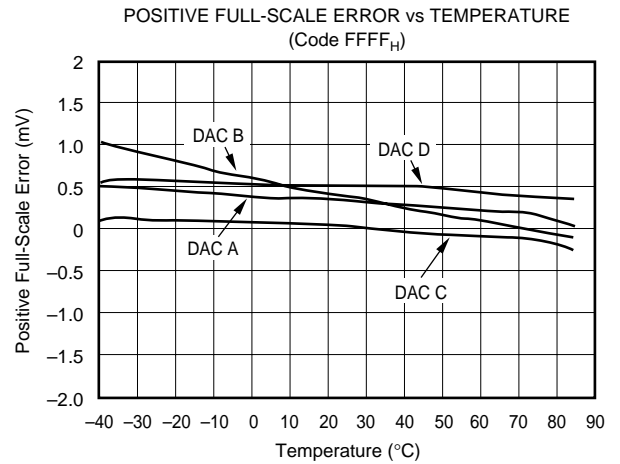
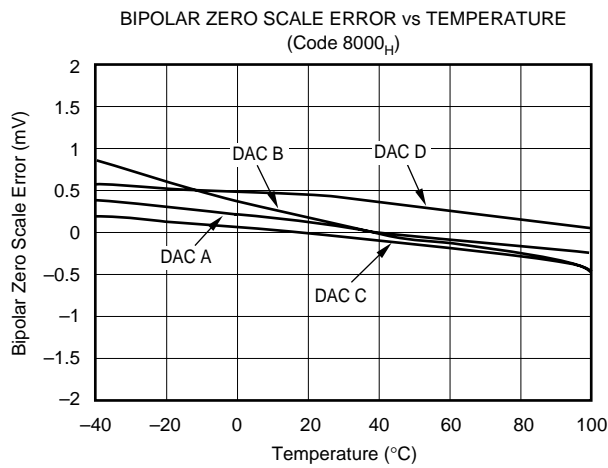
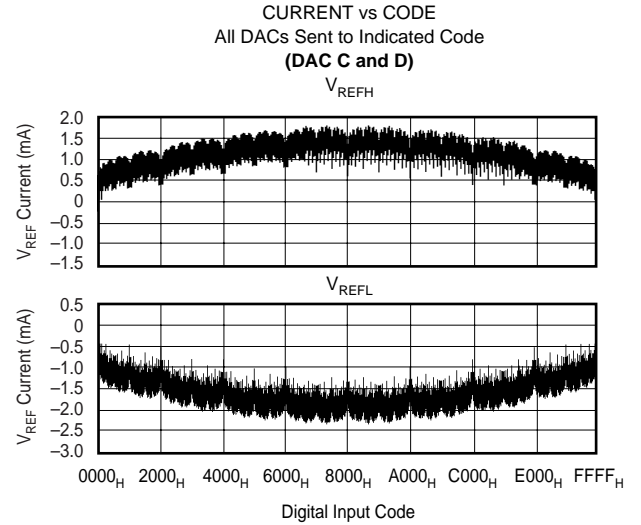
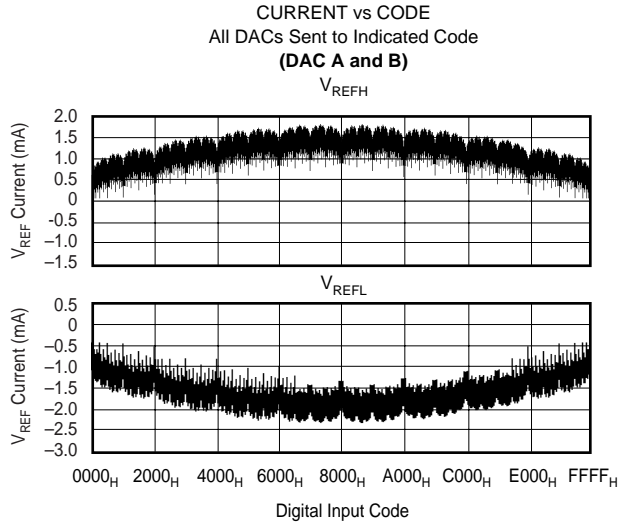

# TYPICAL PERFORMANCE CURVES: $V_{SS} = -15V$ (Cont.)

At  $T_A = +25^\circ C$ ,  $V_{DD} = +5V$ ,  $V_{CC} = +15V$ ,  $V_{SS} = -15V$ ,  $V_{REFH} = +10V$ , and  $V_{REFL} = -10V$ , representative unit, unless otherwise specified.

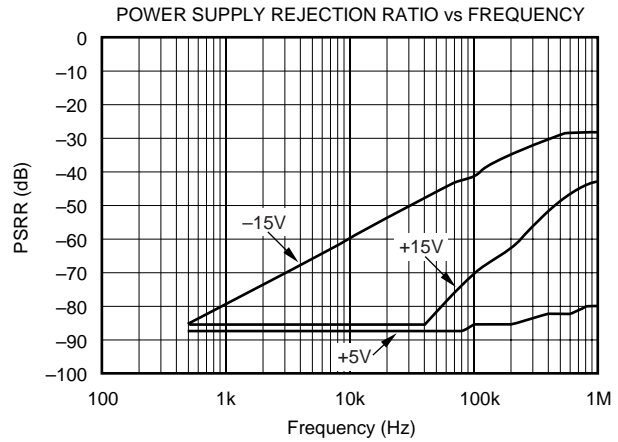
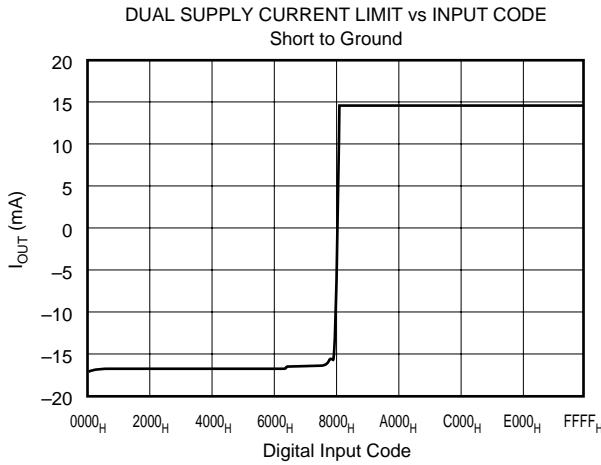
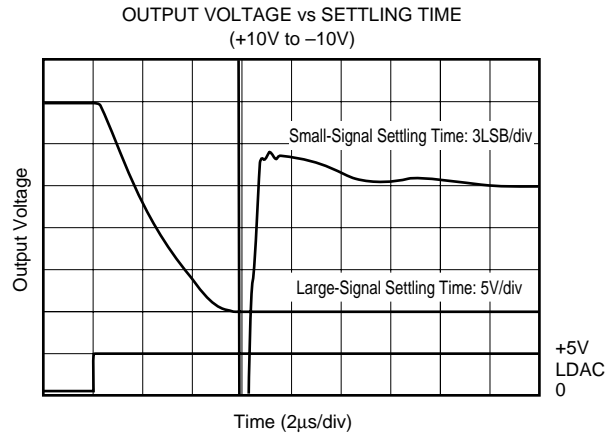
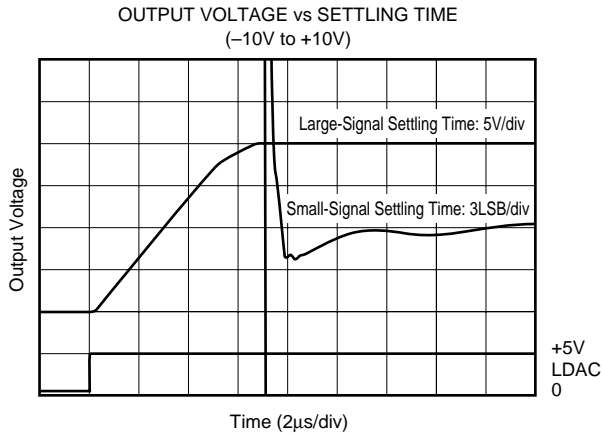
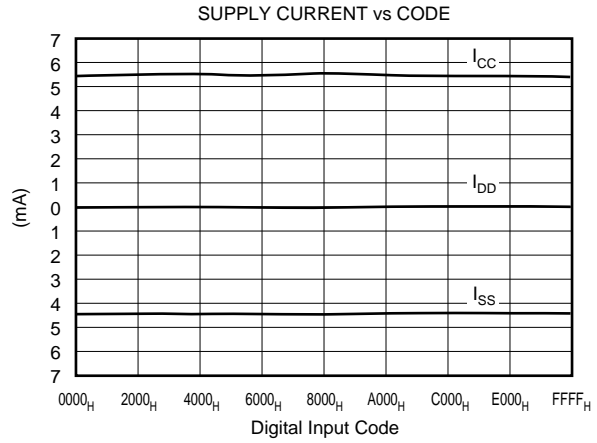
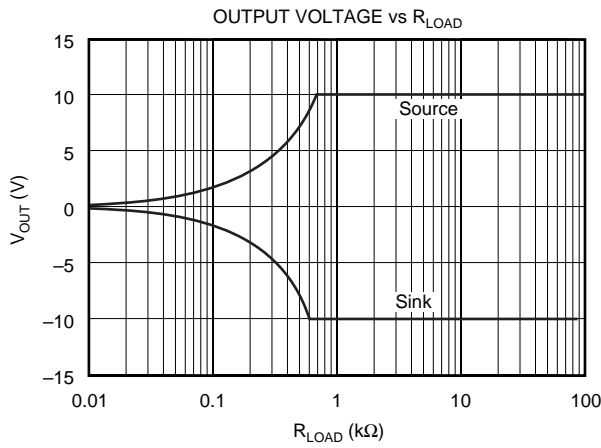

# TYPICAL PERFORMANCE CURVES: $V_{SS} = -15V$ (Cont.)

At  $T_A = +25^\circ C$ ,  $V_{DD} = +5V$ ,  $V_{CC} = +15V$ ,  $V_{SS} = -15V$ ,  $V_{REFH} = +10V$ , and  $V_{REFL} = -10V$ , representative unit, unless otherwise specified.

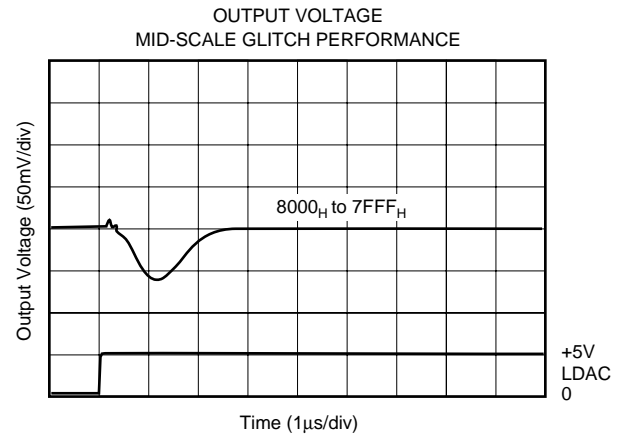
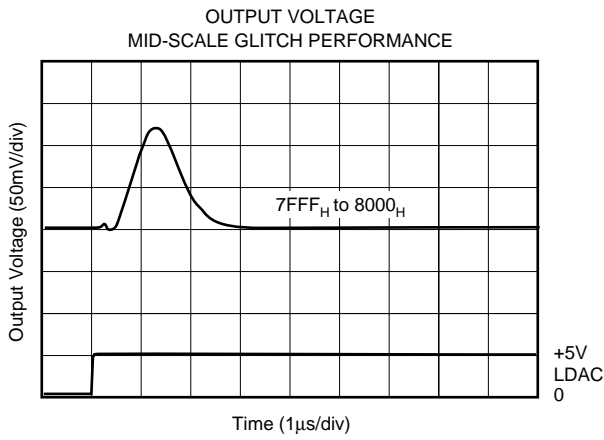

# THEORY OF OPERATION

The DAC7744 is a quad voltage output, 16-bit digital-to-analog converter (DAC). The architecture is an R-2R ladder configuration with the three MSB's segmented followed by an operational amplifier that serves as a buffer. Each DAC has its own R-2R ladder network, segmented MSBs and output op amp (see Figure 1). The minimum voltage output (zero scale) and maximum voltage output (full scale) are set

by the external voltage references ( $V_{REFL}$  and  $V_{REFH}$ , respectively). The digital input is a 16-bit parallel word and the DAC input registers offer a readback capability. The converters can be powered from either a single +15V supply or a dual  $\pm 15V$  supply. The device offers a reset function which immediately sets all DAC output voltages and DAC registers to mid-scale code 8000<sub>H</sub> or to zero scale, code 0000<sub>H</sub>. See Figures 2 and 3 for the basic operation of the DAC7744.

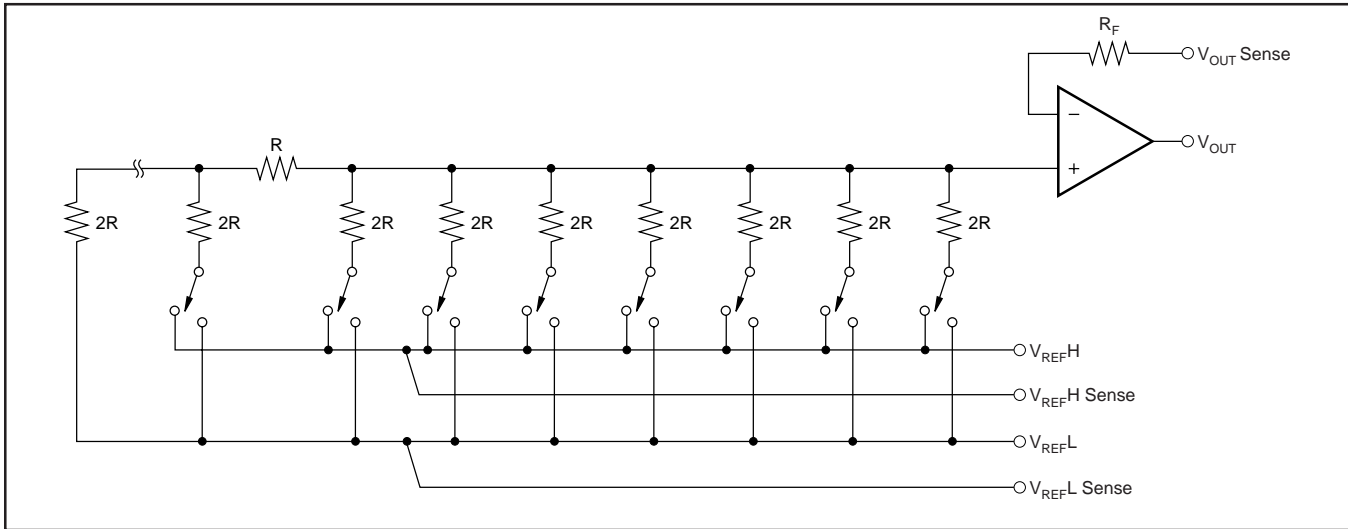

FIGURE 1. DAC7744 Architecture.

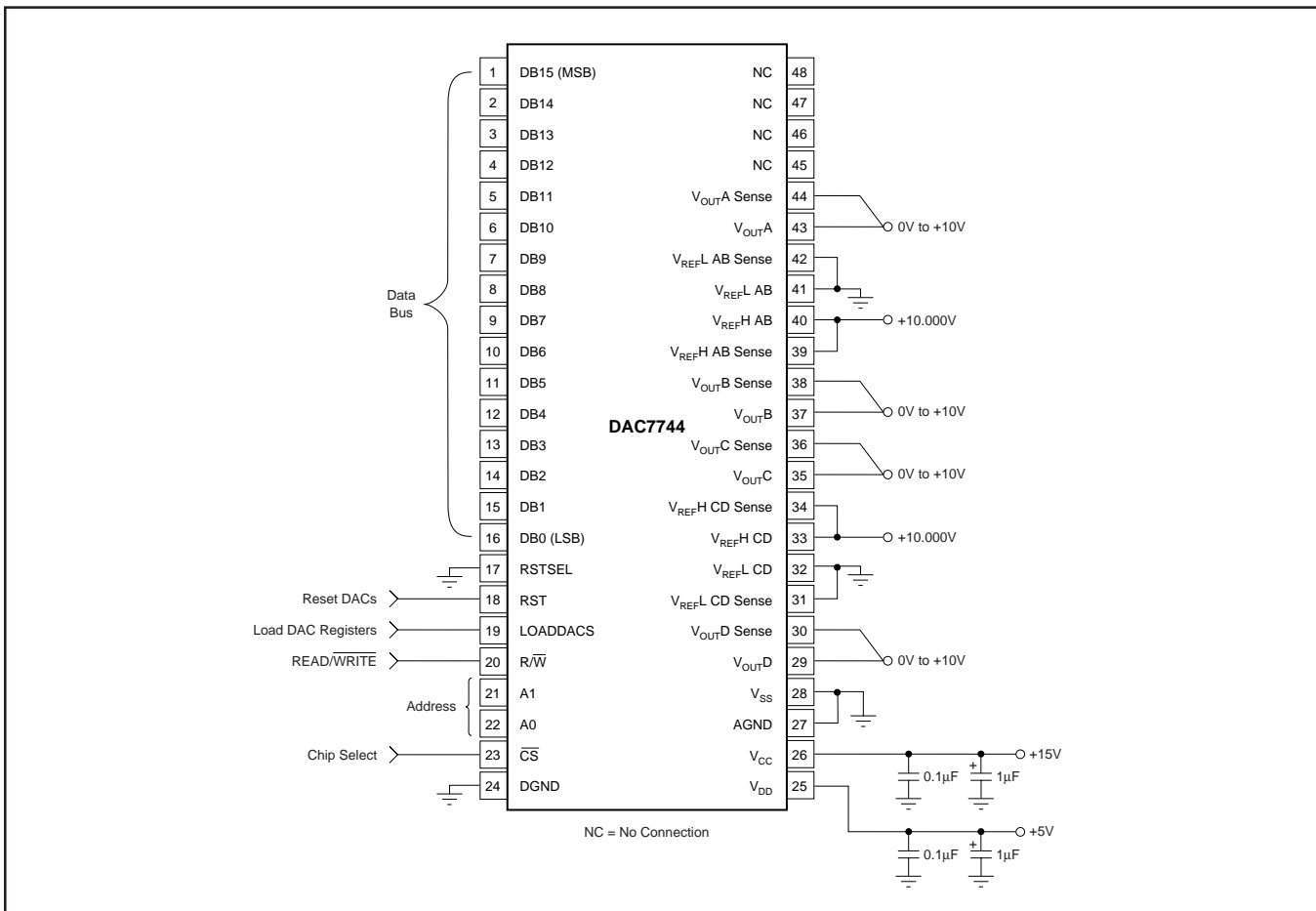

FIGURE 2. Basic Single-Supply Operation of the DAC7744.



## REFERENCE INPUTS

The reference inputs,  $V_{REFL}$  and  $V_{REFH}$ , can be any voltage between  $V_{SS} + 4V$  and  $V_{CC} - 4V$ , provided that  $V_{REFH}$  is at least 1.25V greater than  $V_{REFL}$ . The minimum output of each DAC is equal to  $V_{REFL}$  plus a small offset voltage (essentially, the offset of the output op amp). The maximum output is equal to  $V_{REFH}$  plus a similar offset voltage. Note that  $V_{SS}$  (the negative power supply) must either be connected to ground or must be in the range of  $-14.25V$  to  $-15.75V$ . The voltage on  $V_{SS}$  sets several bias points within the converter. If  $V_{SS}$  is not in one of these two configurations, the bias values may be in error and proper operation of the device is not guaranteed.

The current into the  $V_{REFH}$  input and out of  $V_{REFL}$  depends on the DAC output voltages and can vary from a few

microamps to approximately 2.0mA. The reference input appears as a varying load to the reference. If the reference can sink or source the required current, a reference buffer is not required. The DAC7744 features a reference drive and sense connection such that the internal errors caused by the changing reference current and the circuit impedances can be minimized. Figures 5 through 12 show different reference configurations and the effect on the linearity and differential linearity.

The analog supplies (or the analog supplies and the reference power supplies) have to come up first. If the power supplies for the reference come up first, then the  $V_{CC}$  and  $V_{SS}$  supplies will be “powered from the reference via the ESD protection diode”, see page 4.

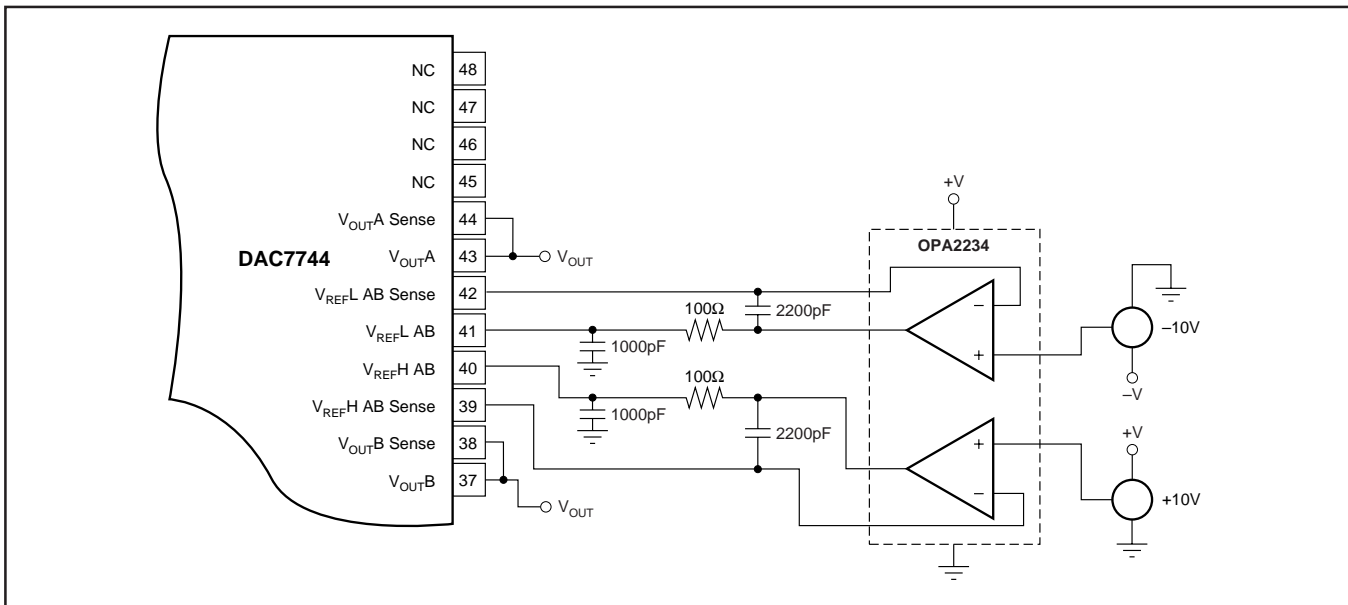

FIGURE 5. Dual Supply Configuration-Buffered References, used for Dual Supply Performance Curves (1/2 DAC7744).

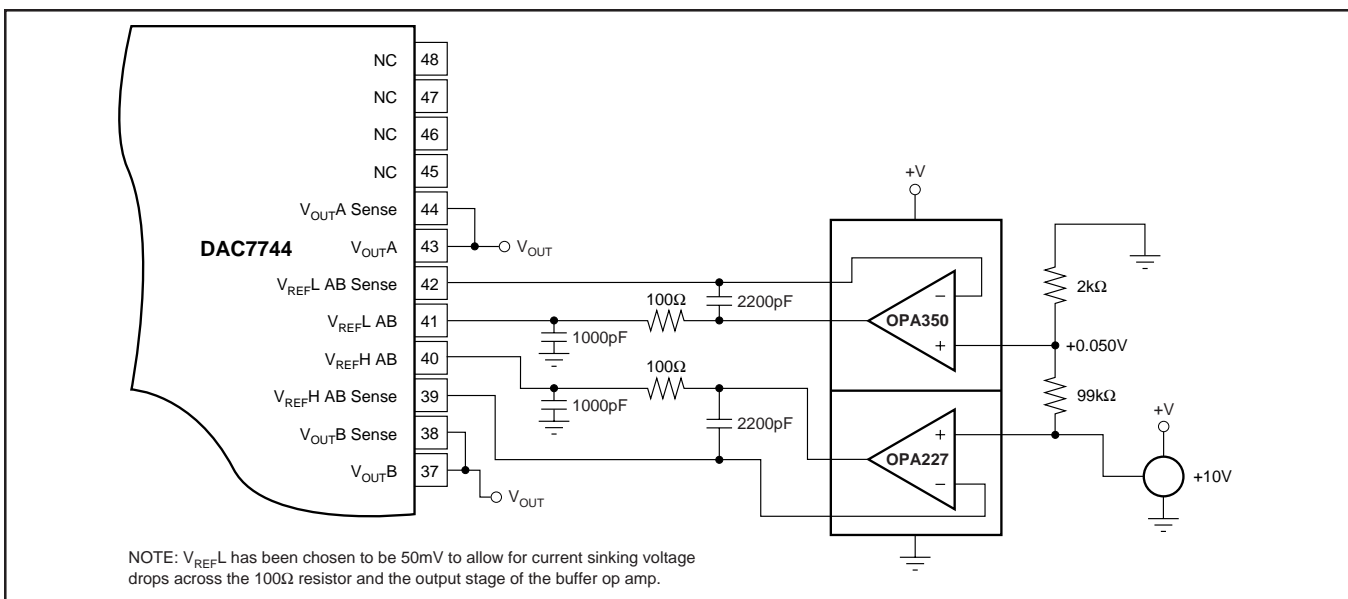

FIGURE 6. Single-Supply Buffered Reference with a Reference Low of 50mV Used for Single-Supply Performance Curves (1/2 DAC7744).



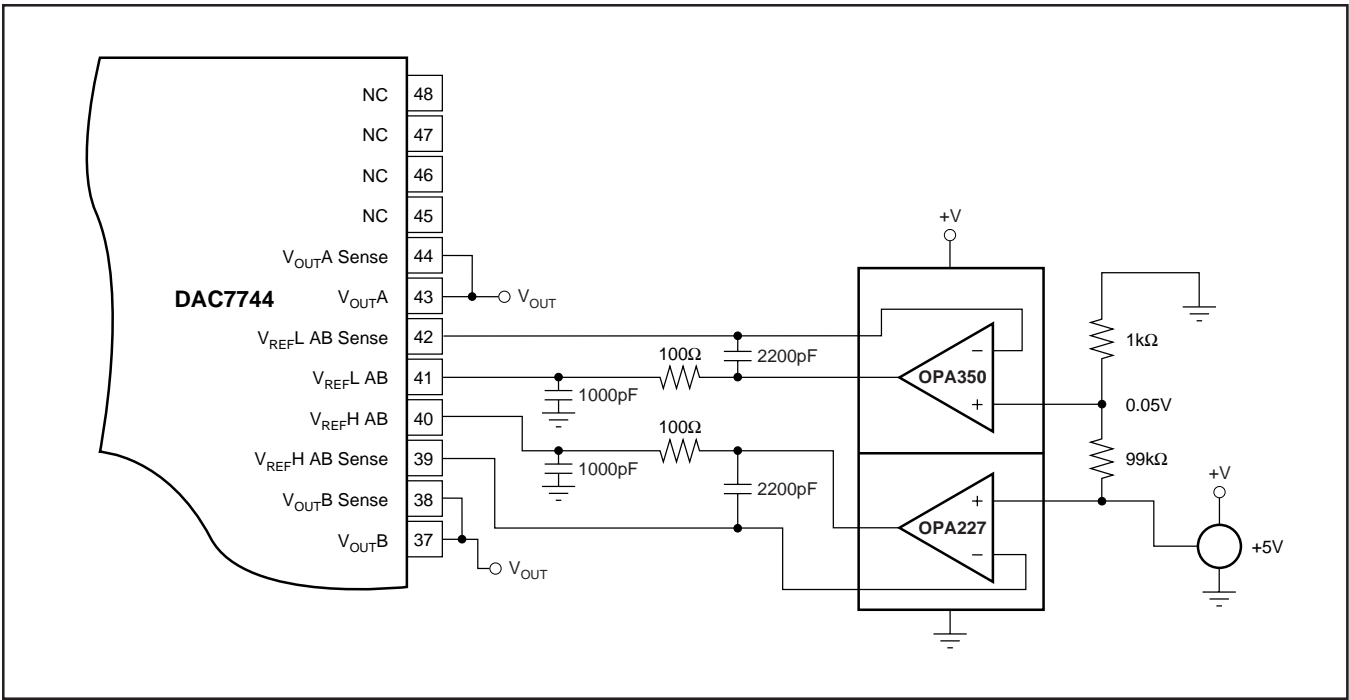

FIGURE 9. Single-Supply Buffered Reference with a Reference Low of 50mV and Reference High of +5V.

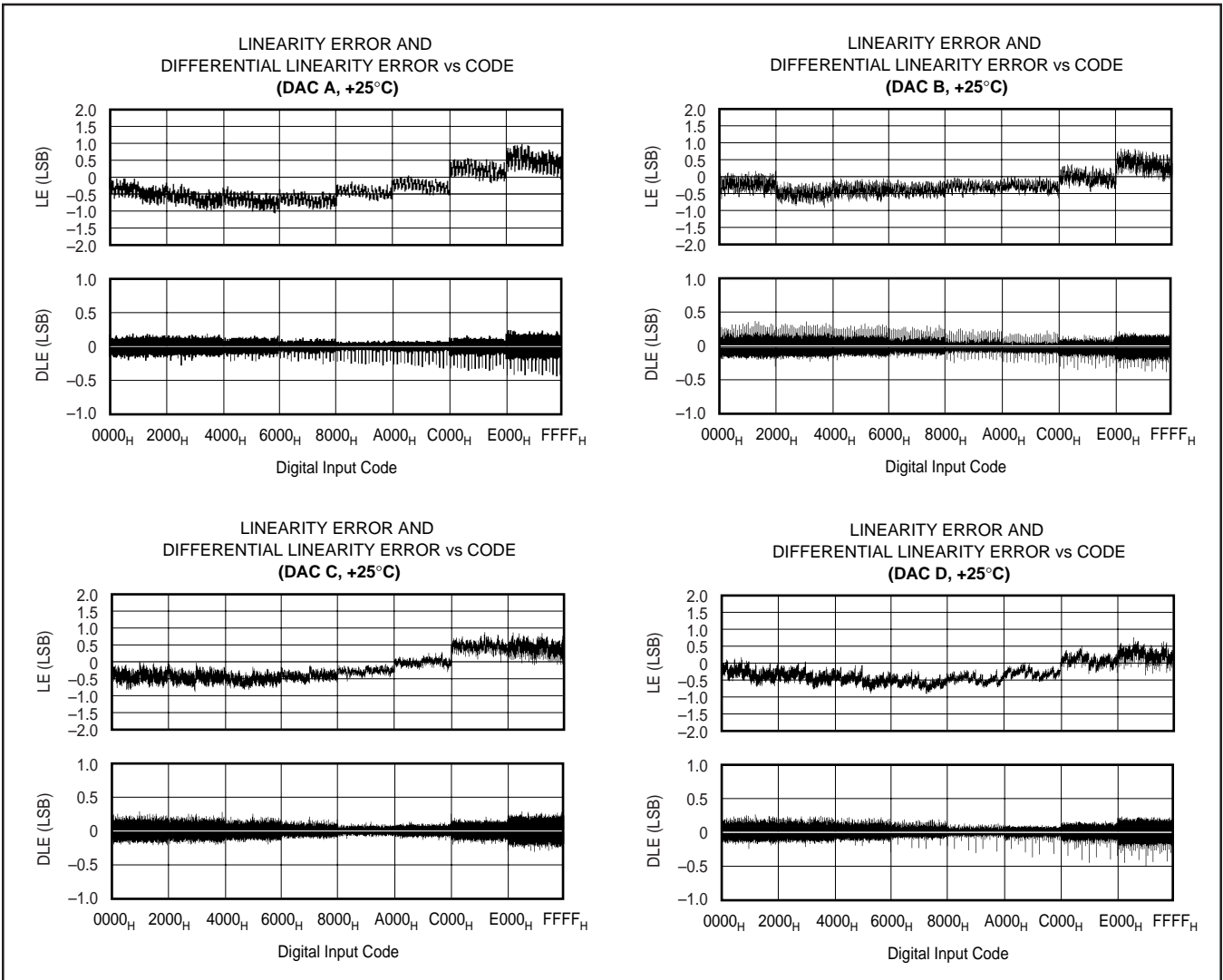

FIGURE 10. Integral Linearity and Differential Linearity Error Curves for Figure 9.

A1	A0	R/W	$\overline{CS}$	RST	RSTSEL	LOADDACS	INPUT REGISTER	DAC REGISTER	MODE	DAC
L	L	L	L	X	X	X	Write	Hold	Write Input	A
L	H	L	L	X	X	X	Write	Hold	Write Input	B
H	L	L	L	X	X	X	Write	Hold	Write Input	C
H	H	L	L	X	X	X	Write	Hold	Write Input	D
L	L	H	L	X	X	X	Read	Hold	Read Input	A
L	H	H	L	X	X	X	Read	Hold	Read Input	B
H	L	H	L	X	X	X	Read	Hold	Read Input	C
H	H	H	L	X	X	X	Read	Hold	Read Input	D
X	X	X	H	X	X	↑	Hold	Write	Update	All
X	X	X	H	X	X	H	Hold	Hold	Hold	All
X	X	X	X	↑	L	X		Reset to Zero	Reset to Zero	All
X	X	X	X	↑	H	X		Reset to Midscale	Reset to Midscale	All

TABLE I. DAC7744 Logic Truth Table.

## DIGITAL INTERFACE

Table I shows the basic control logic for the DAC7744. Note that each DAC register is edge triggered and not level triggered. When the LOADDACS signal is transitioned to HIGH, the digital word currently in the DAC register is latched. The first set of registers (the input registers) are triggered via the A0, A1, R/W, and  $\overline{CS}$  inputs. Only one of these registers is transparent at any given time.

The double-buffered architecture is designed mainly so that each DAC input register can be written to at any time and then all DAC voltages updated simultaneously by the rising edge of LOADDACS. It also allows a DAC input register to be written to at any point then the DAC output voltages can be synchronously changed via a trigger signal connected to LOADDACS.

## DIGITAL TIMING

Figure 11 and Table II provide detailed timing for the digital interface of the DAC7744.

## DIGITAL INPUT CODING

The DAC7744 input data is in Straight Binary format. The output voltage is given by Equation 1.

$$V_{OUT} = V_{REFL} + \frac{(V_{REFH} - V_{REFL}) \cdot N}{65,536} \quad (1)$$

where N is the digital input code. This equation does not include the effects of offset (zero scale) or gain (full scale) errors.

## DIGITALLY-PROGRAMMABLE CURRENT SOURCE

The DAC7744 offers a unique set of features that allows a wide range of flexibility in designing applications circuits such as programmable current sources. The DAC7744 offers both a differential reference input as well as an open-loop configuration around the output amplifier. The open-loop configuration around the output amplifier allows transistor to be placed within the loop to implement a digitally-programmable, uni-directional current source. The availability of a differential reference also allows programmability for both the full-scale and zero-scale currents. The output current is calculated as:

$$I_{OUT} = \left( \left( \frac{V_{REFH} - V_{REFL}}{R_{SENSE}} \right) \cdot \left( \frac{N}{65,536} \right) \right) + (V_{REFL} / R_{SENSE}) \quad (2)$$

Figure 12 shows a DAC7744 in a 4-to-20mA current output configuration. The output current can be determined by Equation 3:

$$I_{OUT} = \left( \left( \frac{5V - 1V}{250\Omega} \right) \cdot \left( \frac{N}{65,536} \right) \right) + \left( \frac{1V}{250\Omega} \right) \quad (3)$$

At full scale, the output current is 16mA plus the 4mA for the zero current. At zero scale, the output current is the offset current of 4mA (1V/250Ω).

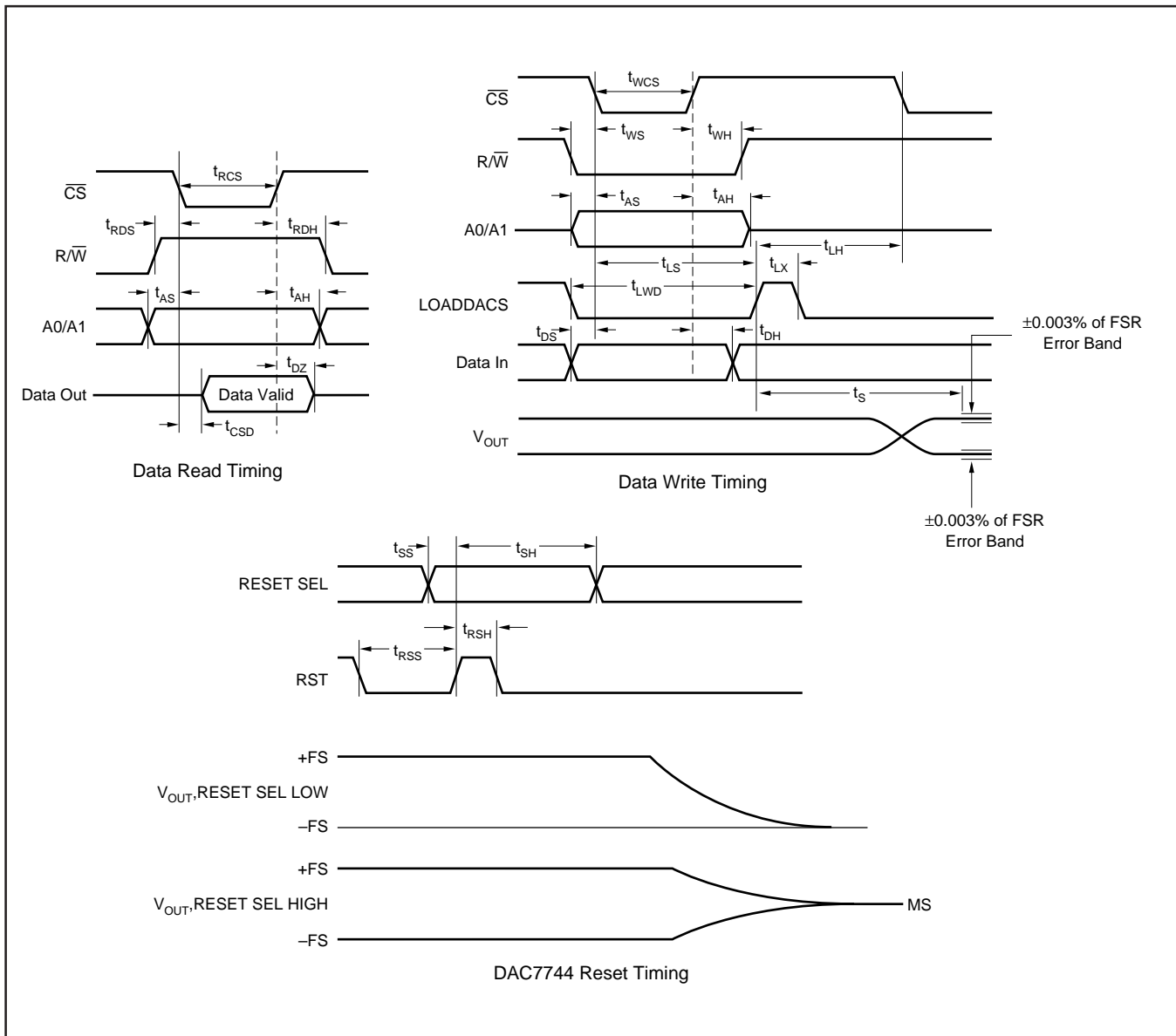

FIGURE 11. Digital Input and Output Timing.

SYMBOL	DESCRIPTION	MIN	TYP	MAX	UNITS
$t_{RCS}$	$\overline{CS}$ LOW for Read	100			ns
$t_{RDS}$	$R/\overline{W}$ HIGH to $\overline{CS}$ LOW	10			ns
$t_{RDH}$	$R/\overline{W}$ HIGH after $\overline{CS}$ HIGH	10			ns
$t_{DZ}$	$\overline{CS}$ HIGH to Data Bus in High Impedance	10		70	ns
$t_{CSD}$	$\overline{CS}$ LOW to Data Bus Valid		85	130	ns
$t_{WCS}$	$\overline{CS}$ LOW for Write	40			ns
$t_{WS}$	$R/\overline{W}$ LOW to $\overline{CS}$ LOW	0			ns
$t_{WH}$	$R/\overline{W}$ LOW after $\overline{CS}$ HIGH	10			ns
$t_{AS}$	Address Valid to $\overline{CS}$ LOW	0			ns
$t_{AH}$	Address Valid after $\overline{CS}$ HIGH	15			ns
$t_{LS}$	$\overline{CS}$ LOW to LOADDACS HIGH	40			ns
$t_{LH}$	$\overline{CS}$ LOW after LOADDACS HIGH	80			ns
$t_{LX}$	LOADDACS HIGH	40			ns
$t_{DS}$	Data Valid to $\overline{CS}$ LOW	0			ns
$t_{DH}$	Data Valid after $\overline{CS}$ HIGH	15			ns
$t_{LWD}$	LOADDACS LOW	40			ns
$t_{SS}$	RSTSEL Valid Before RESET HIGH	0			ns
$t_{SH}$	RSTSEL Valid After RESET HIGH	120			ns
$t_{RSS}$	RESET LOW Before RESET HIGH	10			ns
$t_{RSH}$	RESET LOW After RESET HIGH	10			ns
$t_S$	Settling Time			11	$\mu$ s

TABLE II. Timing Specifications ( $T_A = -40^\circ\text{C}$  to  $+85^\circ\text{C}$ ).

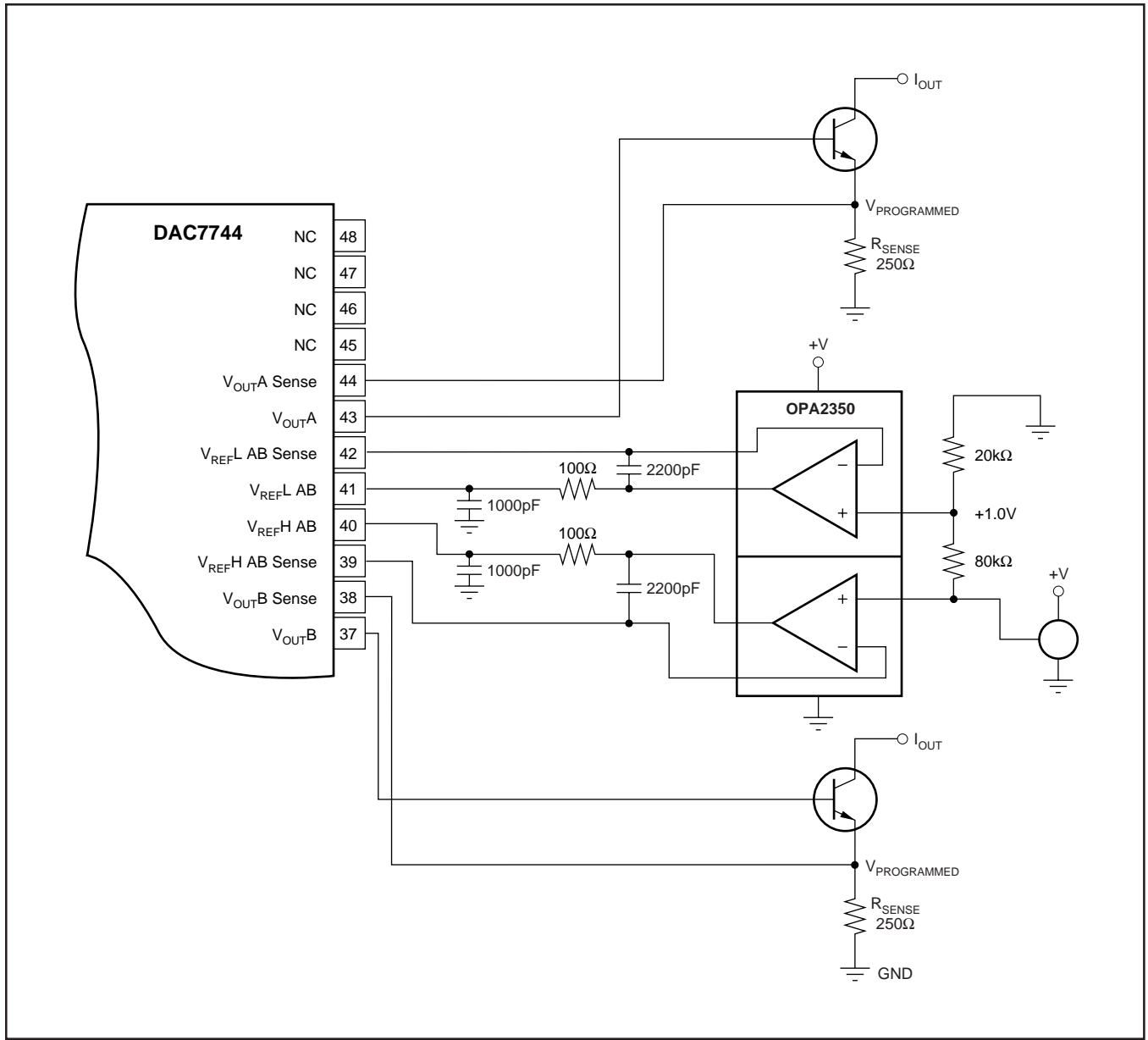

FIGURE 12. 4-to-20mA Digitally-Controlled Current Source (1/2 DAC7744).

**PACKAGING INFORMATION**

Orderable Device	Status (1)	Package Type	Package Drawing	Pins	Package Qty	Eco Plan (2)	Lead/Ball Finish (6)	MSL Peak Temp (3)	Op Temp (°C)	Device Marking (4/5)	Samples
DAC7744E	ACTIVE	SSOP	DL	48	25	Green (RoHS & no Sb/Br)	CU NIPDAU	Level-3-260C-168 HR	-40 to 85	DAC7744E	<a href="#">Samples</a>
DAC7744E/1K	ACTIVE	SSOP	DL	48	1000	Green (RoHS & no Sb/Br)	CU NIPDAU	Level-3-260C-168 HR	-40 to 85	DAC7744E	<a href="#">Samples</a>
DAC7744E/1KG4	ACTIVE	SSOP	DL	48	1000	Green (RoHS & no Sb/Br)	CU NIPDAU	Level-3-260C-168 HR	-40 to 85	DAC7744E	<a href="#">Samples</a>
DAC7744EB	ACTIVE	SSOP	DL	48	25	Green (RoHS & no Sb/Br)	CU NIPDAU	Level-3-260C-168 HR	-40 to 85	DAC7744E B	<a href="#">Samples</a>
DAC7744EB/1K	ACTIVE	SSOP	DL	48	1000	Green (RoHS & no Sb/Br)	CU NIPDAU	Level-3-260C-168 HR	-40 to 85	DAC7744E B	<a href="#">Samples</a>
DAC7744EC	ACTIVE	SSOP	DL	48	25	Green (RoHS & no Sb/Br)	CU NIPDAU	Level-3-260C-168 HR	-40 to 85	DAC7744E C	<a href="#">Samples</a>
DAC7744EC/1K	ACTIVE	SSOP	DL	48	1000	Green (RoHS & no Sb/Br)	CU NIPDAU	Level-3-260C-168 HR	-40 to 85	DAC7744E C	<a href="#">Samples</a>
DAC7744ECG4	ACTIVE	SSOP	DL	48	25	Green (RoHS & no Sb/Br)	CU NIPDAU	Level-3-260C-168 HR	-40 to 85	DAC7744E C	<a href="#">Samples</a>

(1) The marketing status values are defined as follows:

**ACTIVE:** Product device recommended for new designs.

**LIFEBUY:** TI has announced that the device will be discontinued, and a lifetime-buy period is in effect.

**NRND:** Not recommended for new designs. Device is in production to support existing customers, but TI does not recommend using this part in a new design.

**PREVIEW:** Device has been announced but is not in production. Samples may or may not be available.

**OBsolete:** TI has discontinued the production of the device.

(2) **RoHS:** TI defines "RoHS" to mean semiconductor products that are compliant with the current EU RoHS requirements for all 10 RoHS substances, including the requirement that RoHS substance do not exceed 0.1% by weight in homogeneous materials. Where designed to be soldered at high temperatures, "RoHS" products are suitable for use in specified lead-free processes. TI may reference these types of products as "Pb-Free".

**RoHS Exempt:** TI defines "RoHS Exempt" to mean products that contain lead but are compliant with EU RoHS pursuant to a specific EU RoHS exemption.

**Green:** TI defines "Green" to mean the content of Chlorine (Cl) and Bromine (Br) based flame retardants meet JS709B low halogen requirements of <=100ppm threshold. Antimony trioxide based flame retardants must also meet the <=1000ppm threshold requirement.

(3) MSL, Peak Temp. - The Moisture Sensitivity Level rating according to the JEDEC industry standard classifications, and peak solder temperature.

(4) There may be additional marking, which relates to the logo, the lot trace code information, or the environmental category on the device.

<sup>(5)</sup> Multiple Device Markings will be inside parentheses. Only one Device Marking contained in parentheses and separated by a "-" will appear on a device. If a line is indented then it is a continuation of the previous line and the two combined represent the entire Device Marking for that device.

<sup>(6)</sup> Lead/Ball Finish - Orderable Devices may have multiple material finish options. Finish options are separated by a vertical ruled line. Lead/Ball Finish values may wrap to two lines if the finish value exceeds the maximum column width.

**Important Information and Disclaimer:**The information provided on this page represents TI's knowledge and belief as of the date that it is provided. TI bases its knowledge and belief on information provided by third parties, and makes no representation or warranty as to the accuracy of such information. Efforts are underway to better integrate information from third parties. TI has taken and continues to take reasonable steps to provide representative and accurate information but may not have conducted destructive testing or chemical analysis on incoming materials and chemicals. TI and TI suppliers consider certain information to be proprietary, and thus CAS numbers and other limited information may not be available for release.

In no event shall TI's liability arising out of such information exceed the total purchase price of the TI part(s) at issue in this document sold by TI to Customer on an annual basis.

## TAPE AND REEL INFORMATION



### QUADRANT ASSIGNMENTS FOR PIN 1 ORIENTATION IN TAPE



\*All dimensions are nominal

Device	Package Type	Package Drawing	Pins	SPQ	Reel Diameter (mm)	Reel Width W1 (mm)	A0 (mm)	B0 (mm)	K0 (mm)	P1 (mm)	W (mm)	Pin1 Quadrant
DAC7744E/1K	SSOP	DL	48	1000	330.0	32.4	11.35	16.2	3.1	16.0	32.0	Q1
DAC7744EB/1K	SSOP	DL	48	1000	330.0	32.4	11.35	16.2	3.1	16.0	32.0	Q1
DAC7744EC/1K	SSOP	DL	48	1000	330.0	32.4	11.35	16.2	3.1	16.0	32.0	Q1

**TAPE AND REEL BOX DIMENSIONS**

\*All dimensions are nominal

Device	Package Type	Package Drawing	Pins	SPQ	Length (mm)	Width (mm)	Height (mm)
DAC7744E/1K	SSOP	DL	48	1000	367.0	367.0	55.0
DAC7744EB/1K	SSOP	DL	48	1000	367.0	367.0	55.0
DAC7744EC/1K	SSOP	DL	48	1000	367.0	367.0	55.0

## IMPORTANT NOTICE

Texas Instruments Incorporated (TI) reserves the right to make corrections, enhancements, improvements and other changes to its semiconductor products and services per JESD46, latest issue, and to discontinue any product or service per JESD48, latest issue. Buyers should obtain the latest relevant information before placing orders and should verify that such information is current and complete.

TI's published terms of sale for semiconductor products (<http://www.ti.com/sc/docs/stdterms.htm>) apply to the sale of packaged integrated circuit products that TI has qualified and released to market. Additional terms may apply to the use or sale of other types of TI products and services.

Reproduction of significant portions of TI information in TI data sheets is permissible only if reproduction is without alteration and is accompanied by all associated warranties, conditions, limitations, and notices. TI is not responsible or liable for such reproduced documentation. Information of third parties may be subject to additional restrictions. Resale of TI products or services with statements different from or beyond the parameters stated by TI for that product or service voids all express and any implied warranties for the associated TI product or service and is an unfair and deceptive business practice. TI is not responsible or liable for any such statements.

Buyers and others who are developing systems that incorporate TI products (collectively, "Designers") understand and agree that Designers remain responsible for using their independent analysis, evaluation and judgment in designing their applications and that Designers have full and exclusive responsibility to assure the safety of Designers' applications and compliance of their applications (and of all TI products used in or for Designers' applications) with all applicable regulations, laws and other applicable requirements. Designer represents that, with respect to their applications, Designer has all the necessary expertise to create and implement safeguards that (1) anticipate dangerous consequences of failures, (2) monitor failures and their consequences, and (3) lessen the likelihood of failures that might cause harm and take appropriate actions. Designer agrees that prior to using or distributing any applications that include TI products, Designer will thoroughly test such applications and the functionality of such TI products as used in such applications.

TI's provision of technical, application or other design advice, quality characterization, reliability data or other services or information, including, but not limited to, reference designs and materials relating to evaluation modules, (collectively, "TI Resources") are intended to assist designers who are developing applications that incorporate TI products; by downloading, accessing or using TI Resources in any way, Designer (individually or, if Designer is acting on behalf of a company, Designer's company) agrees to use any particular TI Resource solely for this purpose and subject to the terms of this Notice.

TI's provision of TI Resources does not expand or otherwise alter TI's applicable published warranties or warranty disclaimers for TI products, and no additional obligations or liabilities arise from TI providing such TI Resources. TI reserves the right to make corrections, enhancements, improvements and other changes to its TI Resources. TI has not conducted any testing other than that specifically described in the published documentation for a particular TI Resource.

Designer is authorized to use, copy and modify any individual TI Resource only in connection with the development of applications that include the TI product(s) identified in such TI Resource. NO OTHER LICENSE, EXPRESS OR IMPLIED, BY ESTOPPEL OR OTHERWISE TO ANY OTHER TI INTELLECTUAL PROPERTY RIGHT, AND NO LICENSE TO ANY TECHNOLOGY OR INTELLECTUAL PROPERTY RIGHT OF TI OR ANY THIRD PARTY IS GRANTED HEREIN, including but not limited to any patent right, copyright, mask work right, or other intellectual property right relating to any combination, machine, or process in which TI products or services are used. Information regarding or referencing third-party products or services does not constitute a license to use such products or services, or a warranty or endorsement thereof. Use of TI Resources may require a license from a third party under the patents or other intellectual property of the third party, or a license from TI under the patents or other intellectual property of TI.

TI RESOURCES ARE PROVIDED "AS IS" AND WITH ALL FAULTS. TI DISCLAIMS ALL OTHER WARRANTIES OR REPRESENTATIONS, EXPRESS OR IMPLIED, REGARDING RESOURCES OR USE THEREOF, INCLUDING BUT NOT LIMITED TO ACCURACY OR COMPLETENESS, TITLE, ANY EPIDEMIC FAILURE WARRANTY AND ANY IMPLIED WARRANTIES OF MERCHANTABILITY, FITNESS FOR A PARTICULAR PURPOSE, AND NON-INFRINGEMENT OF ANY THIRD PARTY INTELLECTUAL PROPERTY RIGHTS. TI SHALL NOT BE LIABLE FOR AND SHALL NOT DEFEND OR INDEMNIFY DESIGNER AGAINST ANY CLAIM, INCLUDING BUT NOT LIMITED TO ANY INFRINGEMENT CLAIM THAT RELATES TO OR IS BASED ON ANY COMBINATION OF PRODUCTS EVEN IF DESCRIBED IN TI RESOURCES OR OTHERWISE. IN NO EVENT SHALL TI BE LIABLE FOR ANY ACTUAL, DIRECT, SPECIAL, COLLATERAL, INDIRECT, PUNITIVE, INCIDENTAL, CONSEQUENTIAL OR EXEMPLARY DAMAGES IN CONNECTION WITH OR ARISING OUT OF TI RESOURCES OR USE THEREOF, AND REGARDLESS OF WHETHER TI HAS BEEN ADVISED OF THE POSSIBILITY OF SUCH DAMAGES.

Unless TI has explicitly designated an individual product as meeting the requirements of a particular industry standard (e.g., ISO/TS 16949 and ISO 26262), TI is not responsible for any failure to meet such industry standard requirements.

Where TI specifically promotes products as facilitating functional safety or as compliant with industry functional safety standards, such products are intended to help enable customers to design and create their own applications that meet applicable functional safety standards and requirements. Using products in an application does not by itself establish any safety features in the application. Designers must ensure compliance with safety-related requirements and standards applicable to their applications. Designer may not use any TI products in life-critical medical equipment unless authorized officers of the parties have executed a special contract specifically governing such use. Life-critical medical equipment is medical equipment where failure of such equipment would cause serious bodily injury or death (e.g., life support, pacemakers, defibrillators, heart pumps, neurostimulators, and implantables). Such equipment includes, without limitation, all medical devices identified by the U.S. Food and Drug Administration as Class III devices and equivalent classifications outside the U.S.

TI may expressly designate certain products as completing a particular qualification (e.g., Q100, Military Grade, or Enhanced Product). Designers agree that it has the necessary expertise to select the product with the appropriate qualification designation for their applications and that proper product selection is at Designers' own risk. Designers are solely responsible for compliance with all legal and regulatory requirements in connection with such selection.

Designer will fully indemnify TI and its representatives against any damages, costs, losses, and/or liabilities arising out of Designer's non-compliance with the terms and provisions of this Notice.

## Looking for pricing, stock, or lifecycle information?

Click below to explore more details on WIN SOURCE:

 [View DAC7744EB](#) on WIN SOURCE

 [Texas Instruments](#) Information

## Optimize Your Supply Chain with WIN SOURCE Solutions

-  Global Sourcing Solution
-  Obsolete Management
-  Cost Control Management
-  Shortage Management
-  Alternative Solution
-  Excess Inventory Management