



**THE DATASHEET OF
NX5P3290UKZ**



NX5P3290

USB PD and Type-C current-limited power switch

Rev. 1.2 — 7 June 2019

Product data sheet

1. General description

The NX5P3290 is a precision adjustable current-limited power switch for USB PD application. The device includes under voltage lockout, over-temperature protection, and reverse current protection circuits to automatically isolate the switch terminals when a fault condition occurs. The 29 V tolerance on VBUS pin ensures the device is able to work on a USB PD port; a current limit input (ILIM) pin defines the overcurrent limit threshold; an open-drain fault output ($\overline{\text{FLT}}$) indicates when a fault condition has occurred.

The overcurrent limit threshold can be programmed from 400 mA to 3.3 A, using an external resistor between the ILIM pin and GND pin. In the overcurrent condition, the device will clamp the output current to the value set by ILIM and keep the switch on while asserting the $\overline{\text{FLT}}$ flag.

To minimize current surges during normal turn on, the device has built in soft start by limiting the power switch turn on slew rate. However, user can disable the soft start and request a fast output by pulling FO pin HIGH.

A fast RCP recovery circuit has been added to the switch to prevent any reverse current flowing back to power source at all times. When exiting from reverse current protection state, the power MOSFET will turn on within 50 μs . The fast RCP recovery ensures the voltage on VBUS doesn't drop too much in a power source swap application.

NX5P3290 is offered in a 2.05 x 2.05 mm, 16 bump WLCSP package.

2. Features and benefits

- VIN supply voltage range from 4.0 V to 5.5 V
- All time reverse current protection with ultra fast RCP recovery
- Adjustable current limit from 400 mA to 3.3 A
- Clamped current output in overcurrent condition
- 29 V high voltage tolerance on VBUS pin
- Low ON resistance of the power FETs: 35 m Ω (typical) in total
- Over temperature protection
- Safety approvals
 - ◆ UL 62368-1, 2nd edition, file no. 20161017-E470128
 - ◆ IEC 62368-1, 2nd edition, file no. DK-57975-UL
- ESD protection
 - ◆ IEC61000-4-2 contact discharge exceeds 8 kV on VBUS
 - ◆ HBM ANSI/ESDA/JEDEC JS-001 Class 2 exceeds 2 kV
 - ◆ CDM AEC standard Q100-01 (JESD22-C101E) exceeds 500 V
- Specified from $-40\text{ }^{\circ}\text{C}$ to $+85\text{ }^{\circ}\text{C}$ ambient temperature



3. Applications

- Notebook, ultrabook and desktop
- USB PD and Type C port/hubs
- Tablet and smart phone

4. Ordering information

Table 1. Ordering information

Type number	Topside marking	Package		
		Name	Description	Version
NX5P3290UK	X5PT4	WLCSP16	wafer level chip-scale package; 16 bumps; 2.05 x 2.05 mm x 0.555 mm (Backside coating included)	SOT1394-2

4.1 Ordering options

Table 2. Ordering options

Type number	Orderable part number	Package	Packing method	Minimum order quantity	Temperature
NX5P3290UK	NX5P3290UKZ	WLCSP16	REEL 7" Q1/T1 *SPECIAL MARK CHIPS DP	3000	T _{amb} = -40 °C to +85 °C

5. Marking

Table 3. Marking

Line	Marking	Description
A	X5PT4	basic type name
B	mmmmmmnn	wafer lot code (mmmmmm) and wafer number (nn)
C	XtDYYWW	manufacturing code: X = foundry location t = assembly location D = RoHS code (dark green) YY = assembly year code WW = assembly week code

6. Functional diagram

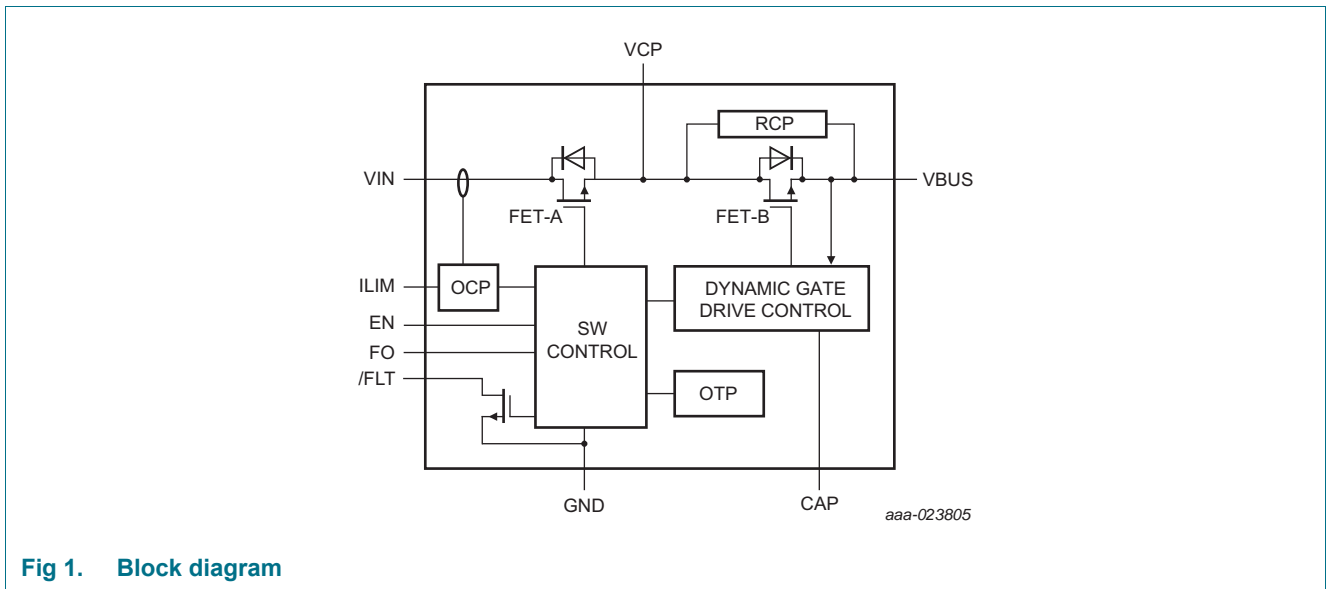

Fig 1. Block diagram

7. Pinning information

7.1 Pinning

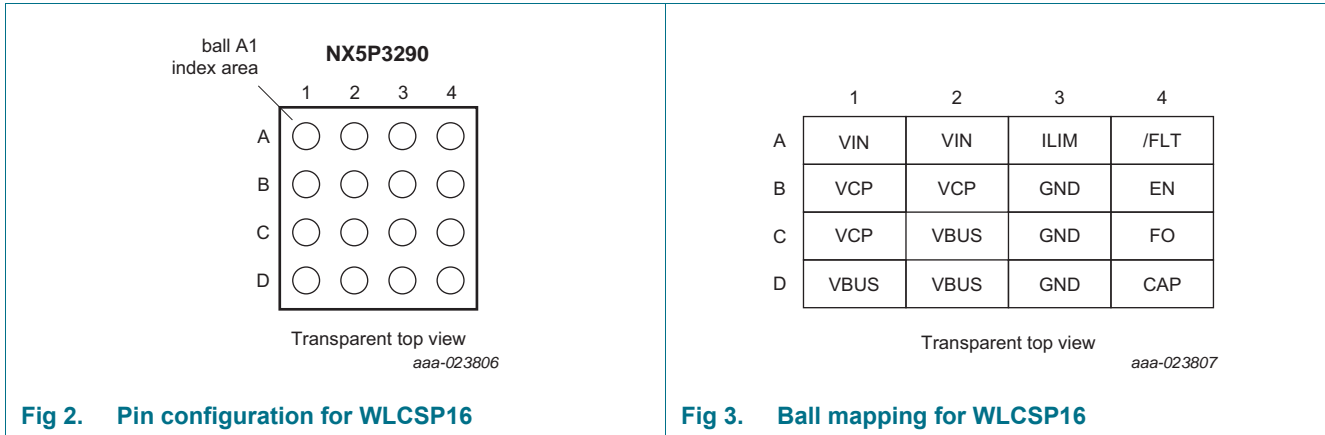

Fig 2. Pin configuration for WLCSP16

Fig 3. Ball mapping for WLCSP16

7.2 Pin description

Table 4. Pin description

Symbol	Pin	Description
VIN	A1, A2	input voltage
VCP	B1, B2, C1	Central point of two power MOSFETs.
VBUS	C2, D1, D2	output voltage
ILIM	A3	current limiter. connect a resistor to GND to adjust the current limit level
$\overline{\text{FLT}}$	A4	fault condition indicator (open-drain output)
EN	B4	enable input (active HIGH with internal 1 M Ω pull down resistor)
GND	B3, C3, D3	ground (0 V)
FO	C4	Fast turn on. Pull this pin HIGH to enable fast turn-on feature. 1 M Ω pull down resistor integrated.
CAP	D4	connect a capacitor to GND

8. Functional description

Table 5. Function table^[1]

EN	FO	VIN	FLT	Main Power Switch
X	X	< 4.0 V	Z	under voltage lockout, Switch open
L	X	4.0 V to 5.5 V	Z	disabled; switch open
H	L	4.0 V to 5.5 V	Z	enabled; switch turns on with slew rate control
H	H	4.0 V to 5.5 V	Z	enabled; switch turns on without slew rate control; fast turn on
H	X	4.0 V to 5.5 V	L	In current limit condition or over temperature protection
X	X	4.0 V to 5.5 V and VIN ≤ VBUS	Z	Reverse protection; switch open

[1] H = HIGH voltage level; L = LOW voltage level.

8.1 EN input

When the EN is set LOW, all the FETs will be disabled, the device will enter low-power mode disabling all protection circuits and setting the FLT output high impedance. When EN is set HIGH, all protection circuits will be enabled and then, if no fault condition exists, the main power MOSFETs will be turn on.

8.2 Fast recovery Reverse-Current Protection (RCP)

NX5P3290 uses dynamic gate drive control loop to implement reverse-current protection. During normal operation, device will always try to regulate the VBUS output voltage to be VIN - 70 mV.

When the load current produces a drop voltage greater than 70 mV, the gate control loop will drive the power MOS to lower its R_{ds(on)} to try to achieve the 70 mV. In the heavy load condition, the gate control loop will keep increasing the gate driving current of the MOSFET until it is fully on and will remain fully on if the voltage drop at that time still exceeds 70 mV.

In light load condition, when the drop voltage is below 70 mV, the gate control loop will reduce the gate driving current to increase the R_{ds(on)} to try to achieve the 70 mV drop voltage, which leads to the complete shutdown of the power MOSFET in reverse voltage condition.

If VBUS voltage is higher than VIN when enabling the device, the power MOSFET will never turn on. The device will always do pre-check before switching on the power MOSFETs.

In the RCP state, EN is HIGH; when the VBUS drops below VIN, the device will exit the RCP state and turn on the power FET again within 50 μs. The fast recovery of the power MOSFET is assisted by the external boost capacitor at CAP pin. The boost capacitor will be charged whenever EN is pulled HIGH.

The RCP circuit, together with dynamic gate drive control circuit, act like an “ideal diode” that protects any reverse current when VBUS rise slew rate is slower than 30mV/us according to USB PD spec. If the VBUS rise slew rate is faster than 30mV/us, there may be reverse current; the current value depends on different slew rate and voltage level.

The input voltage level of FO pin has nothing to do with RCP recovery time.

8.3 Fast Turn ON

In order to reduce the power on inrush current, NX5P3290 has deployed slew rate control for normal turn on; there will be around 2 ms rising time. However, in the quick-swap application, fast turn on is requested. A customer can achieve this by pulling FO pin HIGH. By doing this, rise time will be reduced to the 100 us level. There is an internal 1 M Ω pull-down resistor on this pin.

To support the Fast role swap, the user shall pull up FO pin first, then enable the EN pin of NX5P3290 when the FRS is requested. Depending on the voltage on VBUS, there will be two scenarios:

- $V(\text{VBUS}) > V(\text{VIN})$

The switch will enter RCP mode. Once the voltage on VBUS drops below VIN voltage, switch will be immediately turn on within 50 us.

- $V(\text{VBUS}) \leq V(\text{VIN})$

The switch will perform a fast turn ON as the FO is HIGH; the turn on time is 150 us.

8.4 Under-voltage lock-out

Independently of the logic level on the EN pin, the under-voltage lockout (UVLO) circuit disables the N-channel MOSFET and enters low power mode until the input voltage reaches the UVLO turn-on threshold VUVLO.

8.5 ILIM

The overcurrent protection circuit's (OCP) trigger value I_{OCP} can be set using an external resistor R_{ILIM} connected between ILIM pin and GND pin. When EN is set HIGH and the ILIM pin is grounded, the N-channel MOSFET will be disabled and the $\overline{\text{FLT}}$ output set LOW. The I_{OCP} setting is given in [Table 12](#).

8.6 Main Power FET Overcurrent protection (OCP)

The device offer overcurrent protection when enabled, three possible overcurrent conditions can occur. These conditions are:

- Overcurrent at start-up, $I_{\text{SW}} > I_{\text{OCP}}$ when enabling the N-channel MOSFET.
- Overcurrent when enabled, $I_{\text{SW}} > I_{\text{OCP}}$ when the N-channel MOSFET is enabled.
- Short circuit when enabled, $I_{\text{SW}} > 10 \text{ A}$ (typical).

In the overcurrent condition, because the device clamps the output current rather than completely shut down the switch, the power dissipation on the device might be increased which could lead to over temperature protection (see [Section 8.8](#)).

8.6.1 Overcurrent at start-up

If the device senses a VBUS short to GND or overcurrent while enabling the N-channel MOSFET, $\overline{\text{OCP}}$ is triggered. It limits the output current to I_{OCP} and after the de-glitch time sets the $\overline{\text{FLT}}$ output LOW.

8.6.2 Overcurrent when enabled

If the device senses $I_{\text{SW}} > I_{\text{OCP}}$ when enabled, $\overline{\text{OCP}}$ is triggered. It limits the output current to I_{OCP} and after the de-glitch time sets the $\overline{\text{FLT}}$ output LOW. As a consequence, limiting the output current will reduce $V_{\text{O(VBUS)}}$.

8.6.3 Short circuit when enabled

If the device senses $I_{\text{SW}} > 10 \text{ A}$ when enabled, a short circuit is detected. The device disables the N-channel MOSFET immediately. It then enables the N-channel MOSFET again, output current is limited to I_{OCP} and after the de-glitch time the $\overline{\text{FLT}}$ output is set LOW. Thermal protection will be triggered due to the big power consumption on the device.

8.7 $\overline{\text{FLT}}$ output

The $\overline{\text{FLT}}$ output is an open-drain output that requires an external pull-up resistor. The $\overline{\text{FLT}}$ output will be set LOW to indicate an OCP or OTP condition has occurred. The $\overline{\text{FLT}}$ output will return to the high impedance state automatically once the fault condition is removed. An internal 8 ms de-glitch circuit for the overcurrent protection is used when entering fault conditions. Over-temperature condition doesn't have de-glitch time, the $\overline{\text{FLT}}$ signal will be asserted immediately. The RCP circuit won't trigger $\overline{\text{FLT}}$ signal.

8.8 Over-temperature protection

If the device temperature exceeds 140 °C when EN is set HIGH, the over-temperature protection (OTP) circuit will disable the Power MOSFET and indicate a fault condition by setting the $\overline{\text{FLT}}$ pin LOW. Any transition on the EN pin will have no effect. Once the device temperature decreases to below 115 °C the device will return to the defined state.

In the overcurrent limiting condition, the increased power dissipation on the device will result the OTP, especially in the output-short-to-GND error.

9. Application diagram

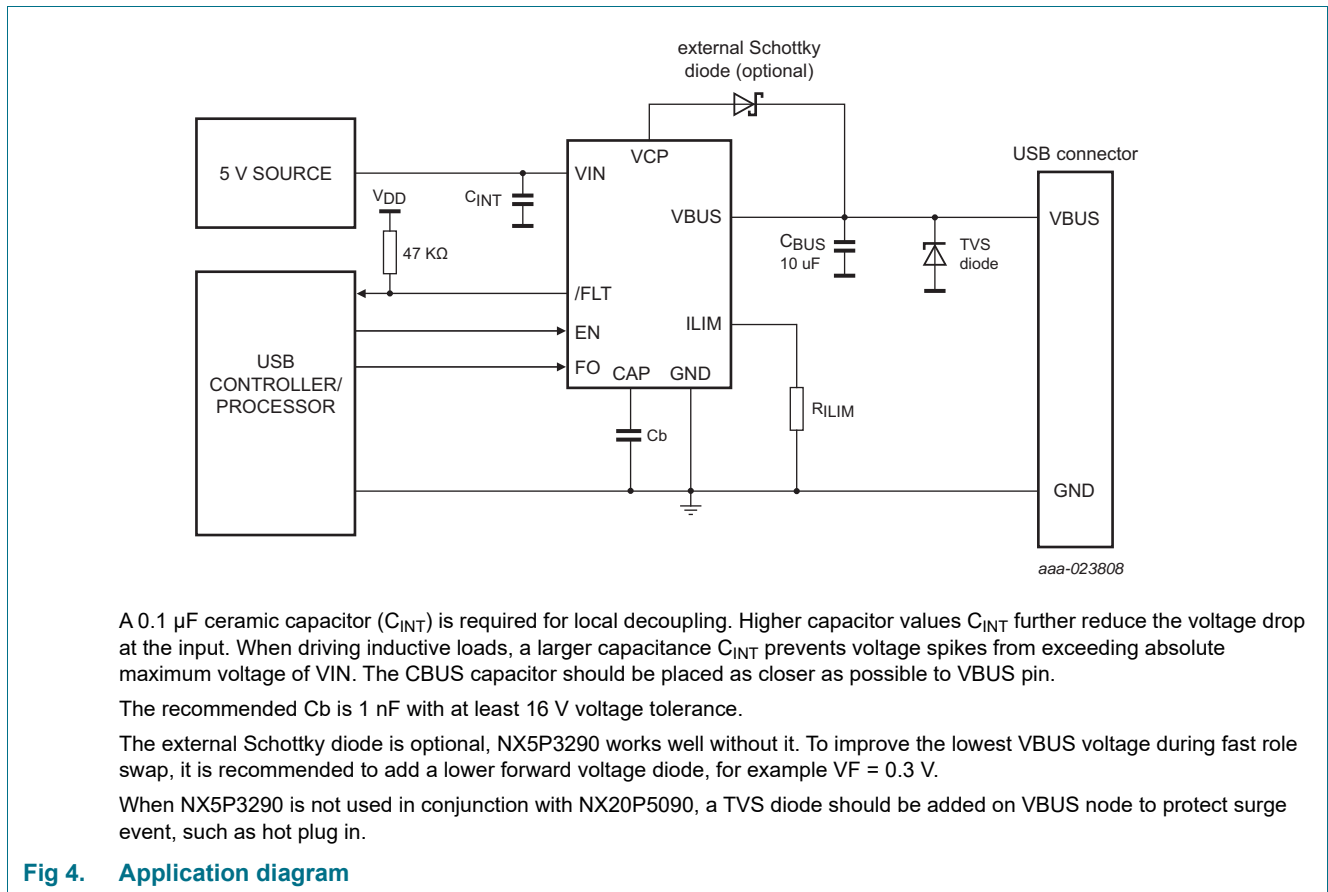

10. Limiting values

Table 6. Limiting values

In accordance with the Absolute Maximum Rating System (IEC 60134). Voltages are referenced to GND (ground = 0 V).

Symbol	Parameter	Conditions	Min	Max	Unit	
V _I	input voltage	VBUS	[1]	-0.5	+29	V
		VIN; VCP; ILIM; EN; FO	[1]	-0.5	+6	V
		CAP	[1]	-0.5	+12	V
V _O	output voltage	$\overline{\text{FLT}}$	[1]	-0.5	+6	V
I _{IK}	input clamping current	input EN: V _{I(EN)} < -0.5 V	-50	-	mA	
I _{I(source)}	input source current	input ILIM	-	1	mA	
I _{SK}	switch clamping current	input VIN: V _{I(VIN)} < -0.5 V	-50	-	mA	
		output VOUT: V _{O(VBUS)} < -0.5 V	-50	-	mA	
I _{SW}	Main Power switch continuous current	V _{SW} > -0.5 V	[2]	-	3.6	A
T _{j(max)}	maximum junction temperature		-40	+125	°C	
T _{stg}	storage temperature		-65	+150	°C	
P _{tot}	total power dissipation		[3]	-	1.7	W

[1] The minimum input voltage rating may be exceeded if the input current rating is observed.

[2] Internally limited.

[3] The (absolute) maximum power dissipation depends on the junction temperature T_j. Higher power dissipation is allowed in conjunction with lower ambient temperatures. The conditions to determine the specified values are T_{amb} = 25 °C and the use of a two layer PCB.

11. Recommended operating conditions

Table 7. Recommended operating conditions

Symbol	Parameter	Conditions	Min	Max	Unit
V _I	input voltage	VIN	4.0	5.5	V
		EN; FO	0	5.5	V
		VBUS (OFF state)	0	23	V
V _O	Output voltage	VBUS; $\overline{\text{FLT}}$	0	5	V
I _{SW}	switch current	T _{amb} = -40 °C to +85 °C	0	3	A
I _{O(sink)}	output sink current	$\overline{\text{FLT}}$	0	10	mA
R _{ILIM}	current limit resistance	ILIM pin to GND	16	140	kΩ
C _{Bus}	VBUS output capacitance	VBUS to GND	10	100	μF
T _{amb}	ambient temperature		-40	+85	°C

12. Thermal characteristics

Table 8. Thermal characteristics

Symbol	Parameter	Conditions	Typ	Unit
$R_{th(j-a)}$	thermal resistance from junction to ambient		[1] 58.4	K/W

[1] $R_{th(j-a)}$ is dependent upon board layout. To minimize $R_{th(j-a)}$, ensure all pins have a solid connection to larger copper layer areas. In multi-layer PCBs, the second layer should be used to create a large heat spreader area below the device. Avoid using solder-stop varnish under the device.

13. Static characteristics

Table 9. Static characteristics

At recommended operating conditions; $V_{I(VIN)} = V_{I(EN)}$, $R_{FAULT} = 10\text{ k}\Omega$ unless otherwise specified; Voltages are referenced to GND (ground = 0 V). See [Figure 9](#)

Symbol	Parameter	Conditions	Min	Typ[1]	Max	Unit
V_{IH}	HIGH-level input voltage	EN; FO; $V_{I(VIN)} = 4.0\text{ V to }5.5\text{ V}$;	1.2	-	-	V
V_{IL}	LOW-level input voltage	EN; FO; $V_{I(VIN)} = 4.0\text{ V to }5.5\text{ V}$;	-	-	0.4	V
I_I	input leakage current	EN; FO; $V_{I(VIN)} = 5.0\text{ V}$;	-	-	7	μA
$I_{(VIN)}$	supply current	VBUS open; $V_{I(VIN)} = 5.0\text{ V}$				
		EN = GND (low power mode);	-	3	55	μA
		EN = $V_{I(VIN)}$; $R_{ILIM} = 33\text{ k}\Omega$	-	1.3	1.65	mA
		EN = $V_{I(VIN)}$; $R_{ILIM} = 16\text{ k}\Omega$	-	1.35	1.65	mA
$I_{S(OFF)}$	VBUS OFF-State leakage current	$V_{I(VIN)} = 5.0\text{ V}$; $V_{I(VBUS)} = 0\text{ V}$; EN = LOW [2]	-5	0.1	-	μA
		$V_{I(VBUS)} = 5.0\text{ V}$; $V_{I(VIN)} = 0\text{ V}$; EN = LOW [2]	-2	0.1	-	μA
		$V_{I(VBUS)} = 20\text{ V}$; $V_{I(VIN)} = 0\text{ V}$; EN = LOW [2]	-2	0.1	-	μA
$I_{S(ON)}$	FET-B leakage current in RCP	$V_{I(VIN)} = 5\text{ V}$; $V_{I(VBUS)} = 20\text{ V}$; EN = 5 V [2] [3]	-2	0.1	-	μA
R_{pd}	Pull-down resistance	EN; FO; $V_{I(VIN)} = 5\text{ V}$	-	1	-	M Ω
V_{UVLO}	under voltage lockout voltage	VIN pin	-	3.6	3.8	V
$V_{hys(UVLO)}$	under voltage lockout hysteresis voltage		-	100	-	mV
V_{OL}	LOW-level output voltage	$\overline{\text{FLT}}$; $I_O = 4\text{ mA}$	-	-	0.3	V
$C_{I(EN)}$	EN pin		-	3	-	pF
$C_{I(FO)}$	FO pin		-	4	-	pF

[1] Typical values are measured at $T_j = 25\text{ }^\circ\text{C}$.

[2] Currents are defined with respect to conventional current flow into the respective terminal. Negative value means the current flows out of the respective terminal of the chip.

[3] Guaranteed by design

13.1 Graphs

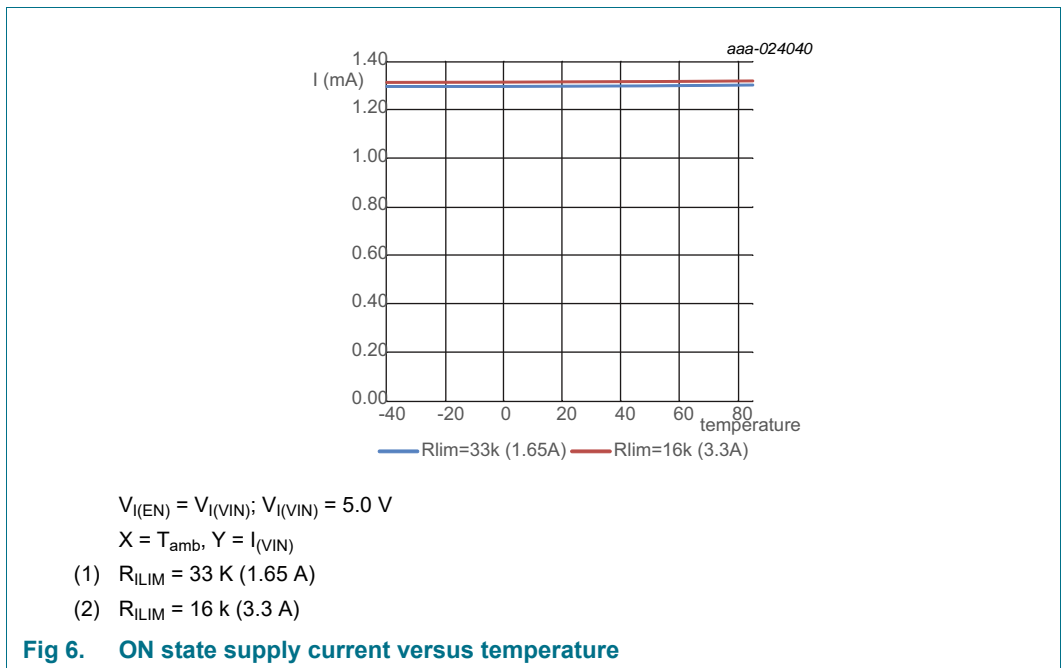
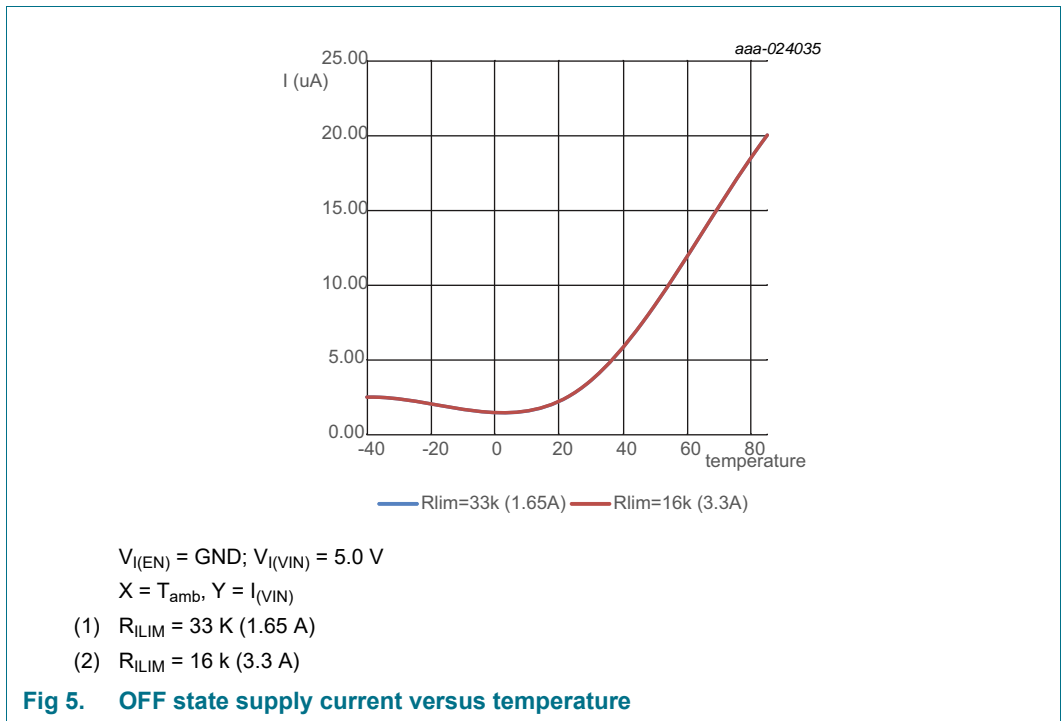

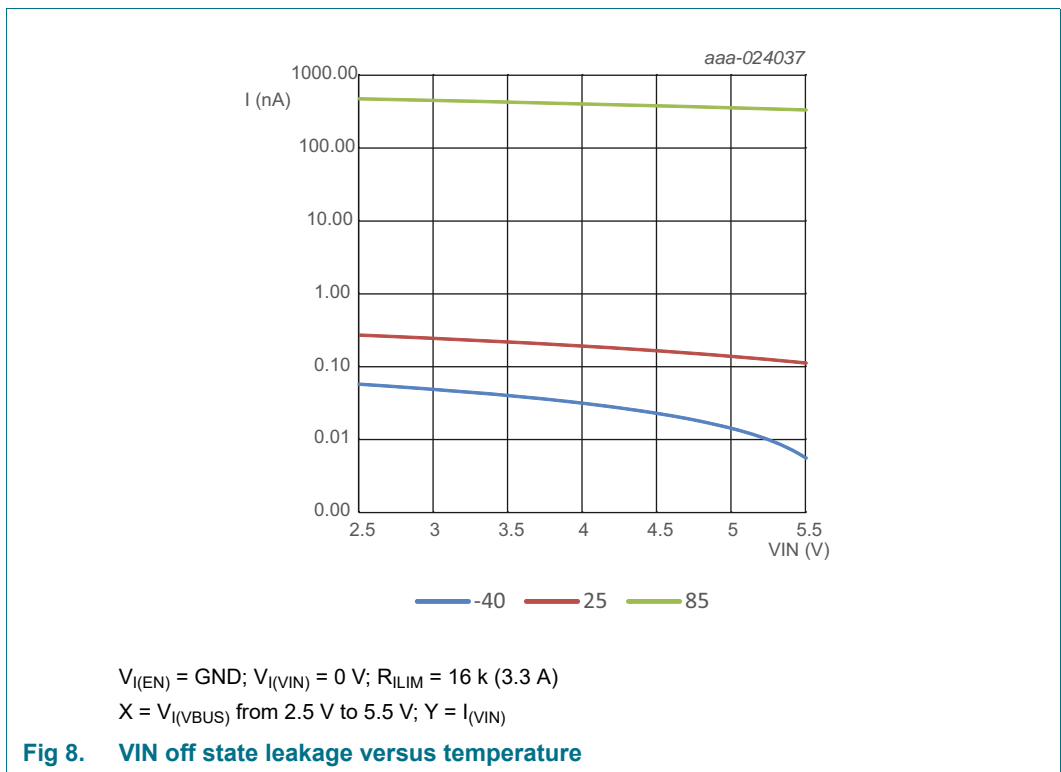
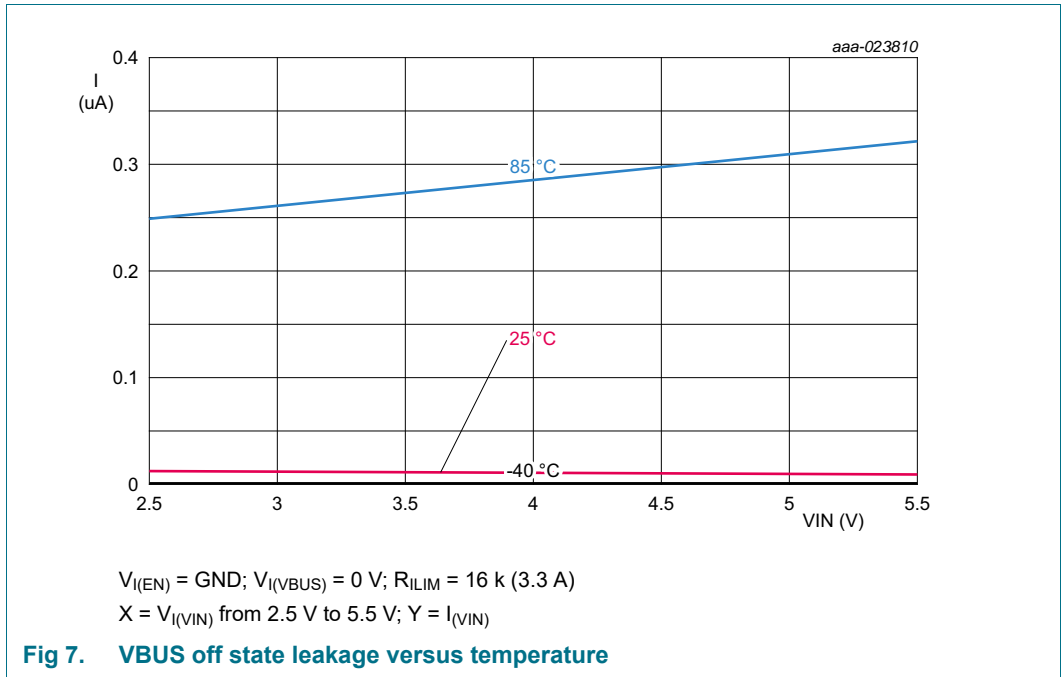

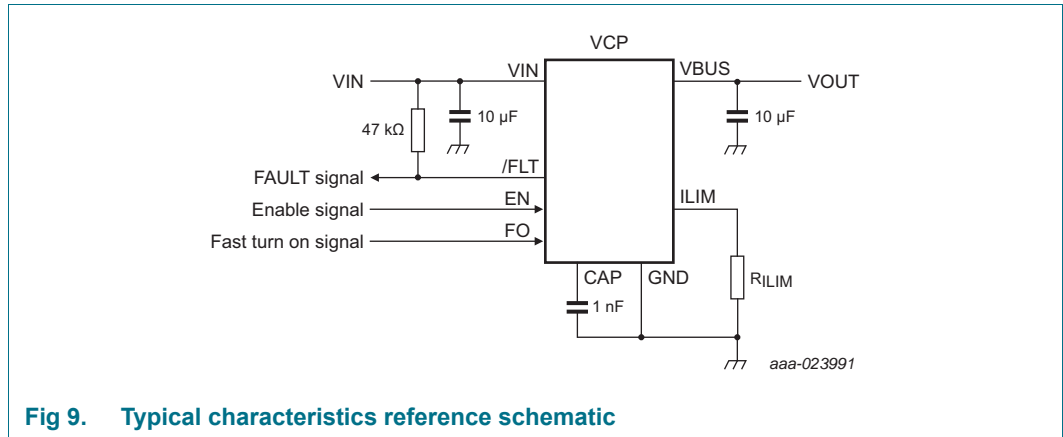

Fig 9. Typical characteristics reference schematic

13.2 Thermal shutdown

Table 10. Thermal shutdown

$V_{I(VIN)} = V_{I(EN)}$, $R_{FAULT} = 10\text{ k}\Omega$ unless otherwise specified; Voltages are referenced to GND (ground = 0 V).

Symbol	Parameter	Conditions	Min	Typ	Max	Unit
$T_{th(ots)}$	over temperature shutdown threshold temperature	$V_{I(VIN)} = 4.0\text{ V to }5.5\text{ V}$	-	140	-	°C
$T_{th(otp)hys}$	hysteresis of over temperature protection threshold temperature	$V_{I(VIN)} = 4.0\text{ V to }5.5\text{ V}$	-	25	-	°C

13.3 ON resistance

Table 11. ON resistance

$V_{I(VIN)} = V_{I(EN)}$, $R_{FAULT} = 10\text{ k}\Omega$ unless otherwise specified; Voltages are referenced to GND (ground = 0 V). See [Figure 9](#)

Symbol	Parameter	Conditions	Min	Typ	Max	Unit
R _{ON}	ON resistance	$R_{FETA} + R_{FETB}$; $V_{I(VIN)} = 4.0$ to 5.5 V ; see Figure 10				
		$T_{amb} = 25\text{ }^\circ\text{C}$	-	35	42	m Ω
		$T_{amb} = -40\text{ }^\circ\text{C}$ to $+85\text{ }^\circ\text{C}$	-	-	49	m Ω

13.4 ON resistance graphs

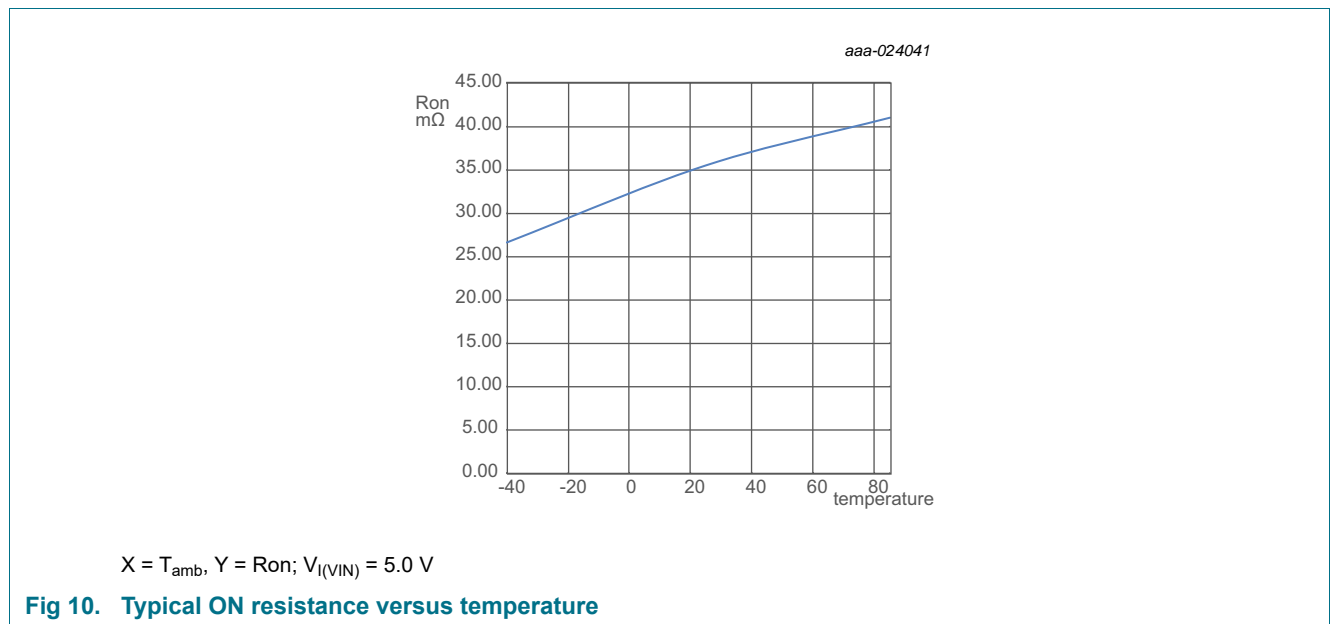

13.5 Current limit

Table 12. Current limit

$V_{I(VIN)} = V_{I(EN)}$, $R_{FAULT} = 10\text{ k}\Omega$ unless otherwise specified; Voltages are referenced to GND (ground = 0 V). See [Figure 9](#)

Symbol	Parameter	Conditions	Min	Typ ^[1]	Max	Unit
I _{OCP}	overcurrent protection current	$V_{I(VIN)} = 4.0\text{ to }5.5\text{ V}$; $T_{amb} = -40\text{ }^{\circ}\text{C to }+85\text{ }^{\circ}\text{C}$; see Figure 11 ,				
		$R_{ILIM} = 140\text{ k}\Omega$	330	400	465	mA
		$R_{ILIM} = 100\text{ k}\Omega$	480	550	625	mA
		$R_{ILIM} = 54\text{ k}\Omega$	915	1013	1107	mA
		$R_{ILIM} = 33\text{ k}\Omega$	1505	1650	1780	mA
		$R_{ILIM} = 24.5\text{ k}\Omega$	2024	2220	2398	mA
		$R_{ILIM} = 20\text{ k}\Omega$	2450	2640	2820	mA
		$R_{ILIM} = 16\text{ k}\Omega$	3100	3300	3531	mA
	ILIM shorted to VIN	168	210	273	mA	

[1] 1% tolerance resistor is recommend for R_{ILIM}

13.6 Current limit graphs

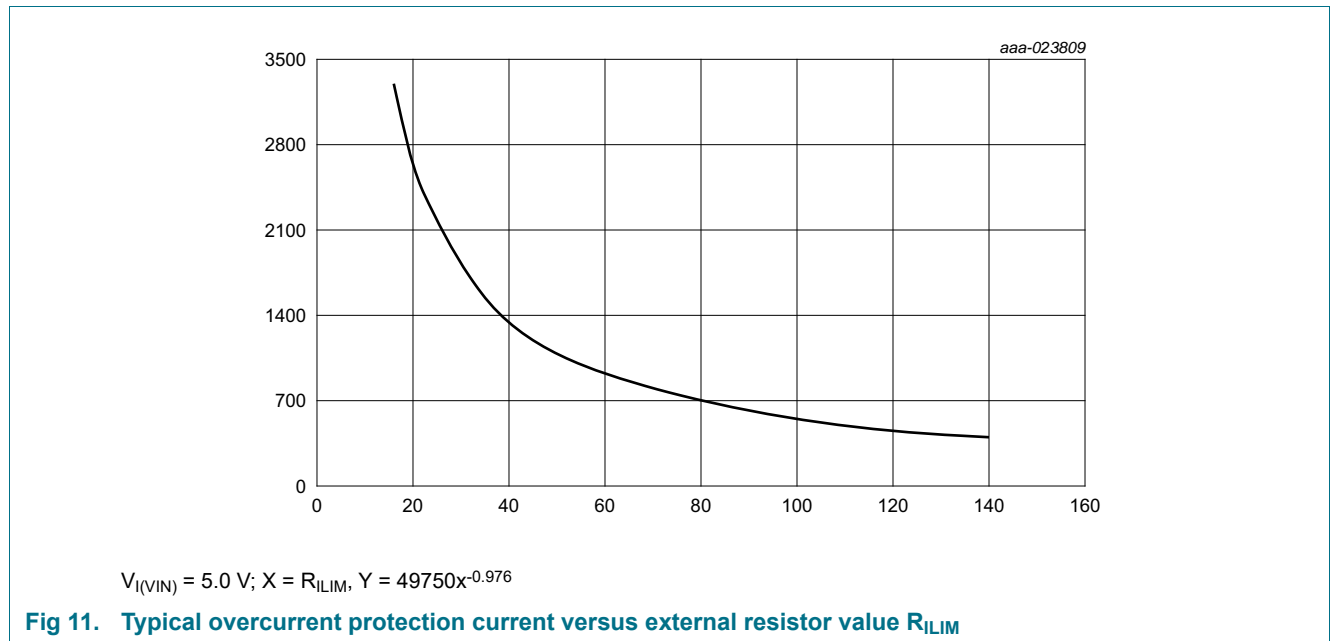

14. Dynamic characteristics

Table 13. Dynamic characteristics

At recommended operating conditions; $V_{I(VIN)} = V_{I(EN)}$, $R_{FAULT} = 10\text{ k}\Omega$ unless otherwise specified; voltages are referenced to GND (ground = 0 V).

Symbol	Parameter	Conditions	Min	Typ ^[1]	Max	Unit
t_{TLH}	LOW to HIGH output transition time	$VBUS$; $V_{I(VIN)} = 5.0\text{ V}$; $C_L = 10\text{ }\mu\text{F}$; $R_L = 100\text{ }\Omega$; see Figure 12 and Figure 13				
		$V_{I(FO)} = \text{GND}$	-	2	-	ms
		$V_{I(FO)} = 5.0\text{ V}$	-	50	100	μs
t_{THL}	HIGH to LOW output transition time	V_{OUT} ; $C_L = 10\text{ }\mu\text{F}$; $R_L = 100\text{ }\Omega$; see Figure 12 and Figure 13				
		$V_{I(VIN)} = 5.0\text{ V}$	-	2.2	-	ms
t_{en}	enable time	EN to V_{OUT} ; $C_L = 10\text{ }\mu\text{F}$; $R_L = 100\text{ }\Omega$; see Figure 14 and Figure 15				
		$V_{I(VIN)} = 5.0\text{ V}$; $V_{I(FO)} = \text{GND}$	-	0.75	-	ms
		$V_{I(VIN)} = 5.0\text{ V}$; $V_{I(FO)} = 5.0\text{ V}$	-	60	-	μs
t_{dis}	disable time	EN to V_{OUT} ; $V_{I(VIN)} = 5.0\text{ V}$; $C_L = 10\text{ }\mu\text{F}$; $R_L = 100\text{ }\Omega$; see Figure 16 and Figure 17	-	70	-	μs
$t_{on(RCP)}$	RCP recovery time	$V_{I(VIN)} = 5.0\text{ V}$; EN = HIGH; From $VBUS$ drops below V_{IN} to FET-B ON; $C_L = 10\text{ }\mu\text{F}$	-	30	50	μs
$t_{dis(RCP)}$	RCP turn off time	FET-B RCP turn OFF time ^[2]	-	10	-	μs
t_{degl}	de-glitch time	FLT in OCP; $V_{I(VIN)} = 5\text{ V}$; see Figure 20 to Figure 21	-	8	-	ms

[1] Typical values are measured at $T_j = 25\text{ }^\circ\text{C}$.

[2] Guaranteed by design

14.1 Waveform and test circuits

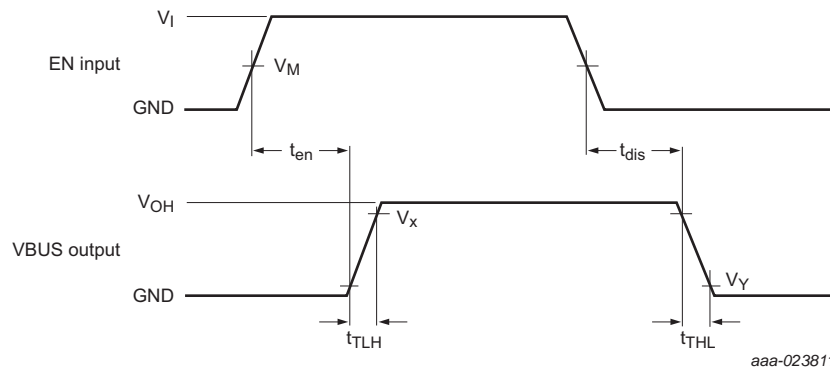

Measurement points are given in [Table 14](#).

Logic level: V_{OH} is the typical output voltage that occurs with the output load.

Fig 12. Switching times and rise and fall times

Table 14. Measurement points

Supply voltage	EN Input	Output	
$V_{I(VIN)}$	V_M	V_X	V_Y
5.0 V	$0.5 \times V_{I(EN)}$	$0.9 \times V_{OH}$	$0.1 \times V_{OH}$

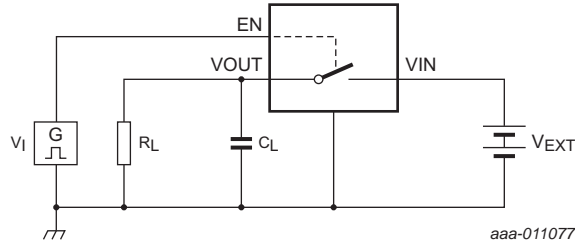

Test data is given in [Table 15](#).

Definitions test circuit:

R_L = Load resistance.

C_L = Load capacitance including jig and probe capacitance.

V_{EXT} = External voltage for measuring switching times.

Fig 13. Test circuit for measuring switching times

Table 15. Test data

Supply voltage	EN Input	Load	
V_{EXT}	$V_{I(EN)}$	C_L	R_L
5.0 V	0 to $V_{I(VIN)}$	10 μ F	100 Ω

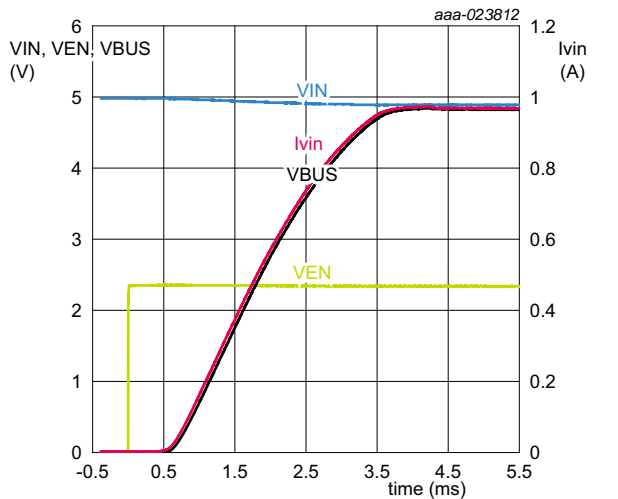

$V_{I(VIN)} = 5\text{ V}; R_L = 5\ \Omega; C_L = 10\ \mu\text{F}; R_{LIM} = 33\ \text{k}\Omega (1.5\ \text{A})$

Fig 14. Typical 10 uF enable time versus inrush current

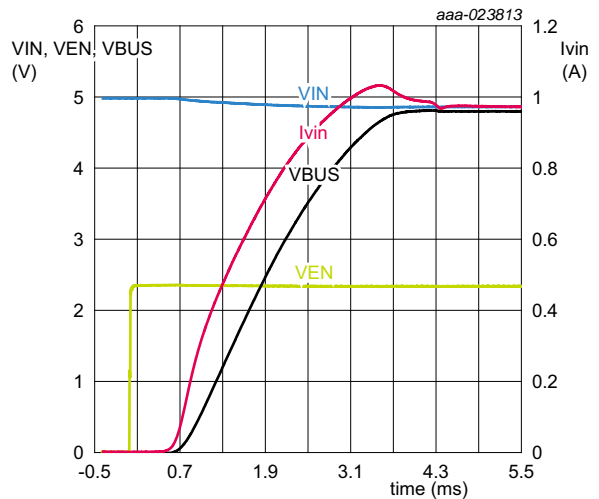

$V_{I(VIN)} = 5\text{ V}; R_L = 5\ \Omega; C_L = 100\ \mu\text{F}; R_{LIM} = 33\ \text{k}\Omega (1.5\ \text{A})$

Fig 15. Typical 100 uF enable time versus inrush current

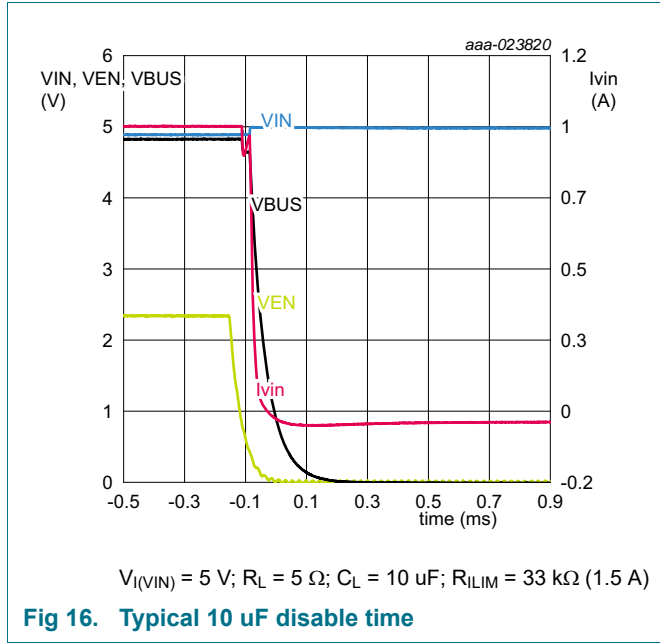

Fig 16. Typical 10 uF disable time

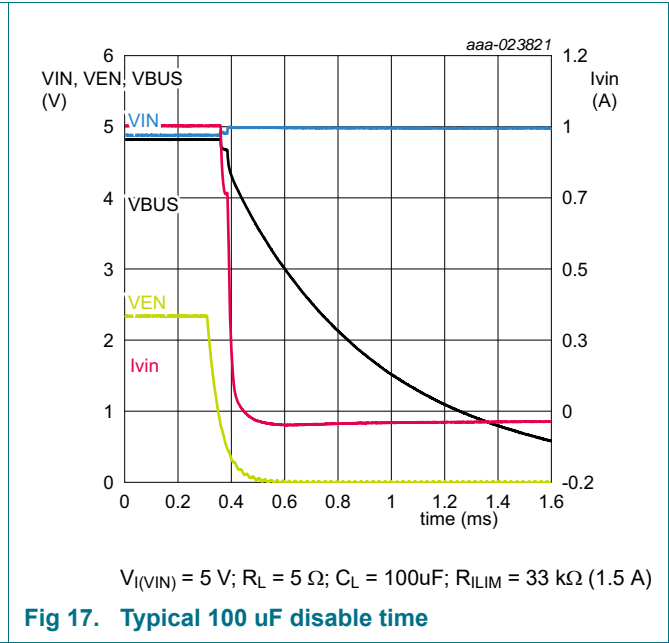

Fig 17. Typical 100 uF disable time

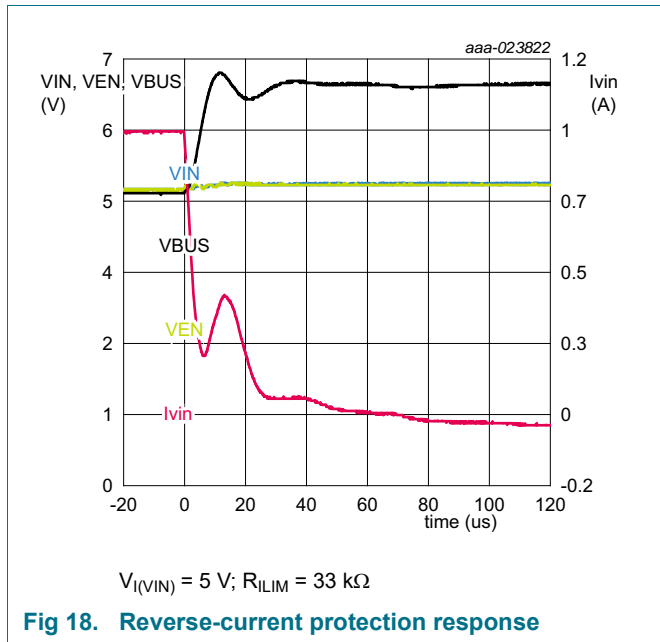

Fig 18. Reverse-current protection response

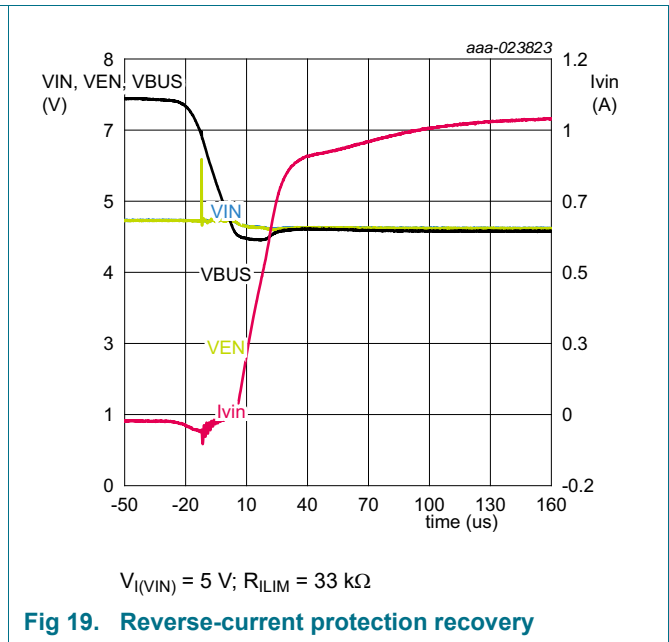
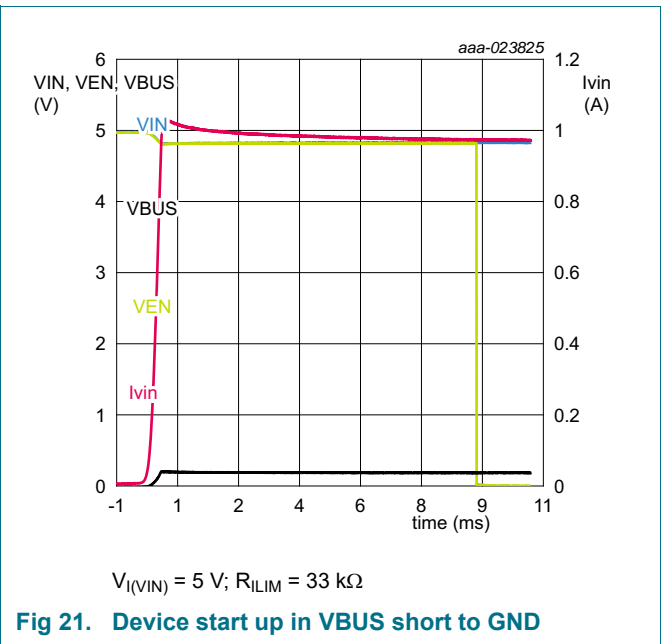
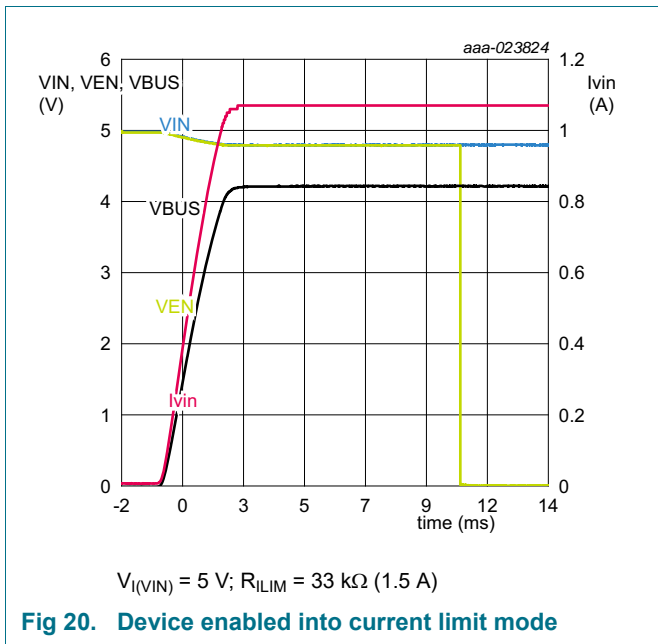

Fig 19. Reverse-current protection recovery



15. Package outline

WLCSP16: wafer level chip-scale package; 16 bumps; 2.05 x 2.05 x 0.555 mm (Backside coating included)

SOT1394-2

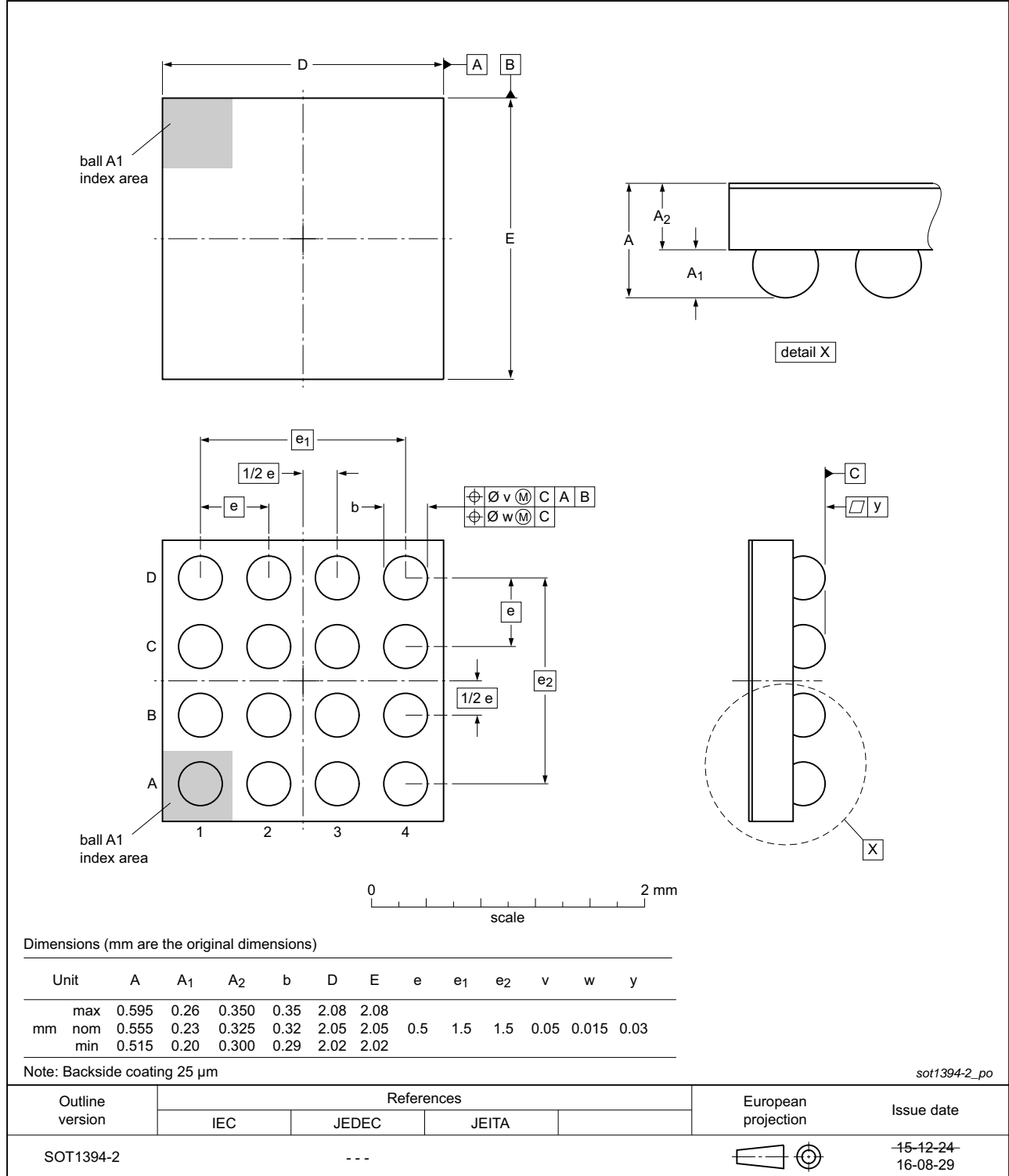

Fig 22. Package outline SOT1394-2 (WLCSP16)

16. Abbreviations

Table 16. Abbreviations

Acronym	Description
ESD	ElectroStatic Discharge
CDM	Charged Device Model
HBM	Human Body Model
USB	Universal Serial Bus
VOIP	Voice over Internet Protocol

17. Revision history

Table 17. Revision history

Document ID	Release date	Data sheet status	Change notice	Supersedes
NX5P3290 v.1.2	20190607	Product data sheet	-	NX5P3290 v.1.1
Modifications:	<ul style="list-style-type: none"> Table 6 "Limiting values", V_I: Created separate row for pin CAP 			
NX5P3290 v.1.1	20170613	Product data sheet	-	NX5P3290 v.1
Modifications:	<ul style="list-style-type: none"> Table 7 "Recommended operating conditions", V_I: Created separate row for pins EN and FO 			
NX5P3290 v.1	20161101	Product data sheet	-	-

18. Legal information

18.1 Data sheet status

Document status ^{[1][2]}	Product status ^[3]	Definition
Objective [short] data sheet	Development	This document contains data from the objective specification for product development.
Preliminary [short] data sheet	Qualification	This document contains data from the preliminary specification.
Product [short] data sheet	Production	This document contains the product specification.

[1] Please consult the most recently issued document before initiating or completing a design.

[2] The term 'short data sheet' is explained in section "Definitions".

[3] The product status of device(s) described in this document may have changed since this document was published and may differ in case of multiple devices. The latest product status information is available on the Internet at URL <http://www.nxp.com>.

18.2 Definitions

Draft — The document is a draft version only. The content is still under internal review and subject to formal approval, which may result in modifications or additions. NXP Semiconductors does not give any representations or warranties as to the accuracy or completeness of information included herein and shall have no liability for the consequences of use of such information.

Short data sheet — A short data sheet is an extract from a full data sheet with the same product type number(s) and title. A short data sheet is intended for quick reference only and should not be relied upon to contain detailed and full information. For detailed and full information see the relevant full data sheet, which is available on request via the local NXP Semiconductors sales office. In case of any inconsistency or conflict with the short data sheet, the full data sheet shall prevail.

Product specification — The information and data provided in a Product data sheet shall define the specification of the product as agreed between NXP Semiconductors and its customer, unless NXP Semiconductors and customer have explicitly agreed otherwise in writing. In no event however, shall an agreement be valid in which the NXP Semiconductors product is deemed to offer functions and qualities beyond those described in the Product data sheet.

18.3 Disclaimers

Limited warranty and liability — Information in this document is believed to be accurate and reliable. However, NXP Semiconductors does not give any representations or warranties, expressed or implied, as to the accuracy or completeness of such information and shall have no liability for the consequences of use of such information. NXP Semiconductors takes no responsibility for the content in this document if provided by an information source outside of NXP Semiconductors.

In no event shall NXP Semiconductors be liable for any indirect, incidental, punitive, special or consequential damages (including - without limitation - lost profits, lost savings, business interruption, costs related to the removal or replacement of any products or rework charges) whether or not such damages are based on tort (including negligence), warranty, breach of contract or any other legal theory.

Notwithstanding any damages that customer might incur for any reason whatsoever, NXP Semiconductors' aggregate and cumulative liability towards customer for the products described herein shall be limited in accordance with the *Terms and conditions of commercial sale* of NXP Semiconductors.

Right to make changes — NXP Semiconductors reserves the right to make changes to information published in this document, including without limitation specifications and product descriptions, at any time and without notice. This document supersedes and replaces all information supplied prior to the publication hereof.

Suitability for use — NXP Semiconductors products are not designed, authorized or warranted to be suitable for use in life support, life-critical or safety-critical systems or equipment, nor in applications where failure or malfunction of an NXP Semiconductors product can reasonably be expected to result in personal injury, death or severe property or environmental damage. NXP Semiconductors and its suppliers accept no liability for inclusion and/or use of NXP Semiconductors products in such equipment or applications and therefore such inclusion and/or use is at the customer's own risk.

Applications — Applications that are described herein for any of these products are for illustrative purposes only. NXP Semiconductors makes no representation or warranty that such applications will be suitable for the specified use without further testing or modification.

Customers are responsible for the design and operation of their applications and products using NXP Semiconductors products, and NXP Semiconductors accepts no liability for any assistance with applications or customer product design. It is customer's sole responsibility to determine whether the NXP Semiconductors product is suitable and fit for the customer's applications and products planned, as well as for the planned application and use of customer's third party customer(s). Customers should provide appropriate design and operating safeguards to minimize the risks associated with their applications and products.

NXP Semiconductors does not accept any liability related to any default, damage, costs or problem which is based on any weakness or default in the customer's applications or products, or the application or use by customer's third party customer(s). Customer is responsible for doing all necessary testing for the customer's applications and products using NXP Semiconductors products in order to avoid a default of the applications and the products or of the application or use by customer's third party customer(s). NXP does not accept any liability in this respect.

Limiting values — Stress above one or more limiting values (as defined in the Absolute Maximum Ratings System of IEC 60134) will cause permanent damage to the device. Limiting values are stress ratings only and (proper) operation of the device at these or any other conditions above those given in the Recommended operating conditions section (if present) or the Characteristics sections of this document is not warranted. Constant or repeated exposure to limiting values will permanently and irreversibly affect the quality and reliability of the device.

Terms and conditions of commercial sale — NXP Semiconductors products are sold subject to the general terms and conditions of commercial sale, as published at <http://www.nxp.com/profile/terms>, unless otherwise agreed in a valid written individual agreement. In case an individual agreement is concluded only the terms and conditions of the respective agreement shall apply. NXP Semiconductors hereby expressly objects to applying the customer's general terms and conditions with regard to the purchase of NXP Semiconductors products by customer.

No offer to sell or license — Nothing in this document may be interpreted or construed as an offer to sell products that is open for acceptance or the grant, conveyance or implication of any license under any copyrights, patents or other industrial or intellectual property rights.

Export control — This document as well as the item(s) described herein may be subject to export control regulations. Export might require a prior authorization from competent authorities.

Non-automotive qualified products — Unless this data sheet expressly states that this specific NXP Semiconductors product is automotive qualified, the product is not suitable for automotive use. It is neither qualified nor tested in accordance with automotive testing or application requirements. NXP Semiconductors accepts no liability for inclusion and/or use of non-automotive qualified products in automotive equipment or applications.

In the event that customer uses the product for design-in and use in automotive applications to automotive specifications and standards, customer (a) shall use the product without NXP Semiconductors' warranty of the product for such automotive applications, use and specifications, and (b) whenever customer uses the product for automotive applications beyond

NXP Semiconductors' specifications such use shall be solely at customer's own risk, and (c) customer fully indemnifies NXP Semiconductors for any liability, damages or failed product claims resulting from customer design and use of the product for automotive applications beyond NXP Semiconductors' standard warranty and NXP Semiconductors' product specifications.

Translations — A non-English (translated) version of a document is for reference only. The English version shall prevail in case of any discrepancy between the translated and English versions.

18.4 Trademarks

Notice: All referenced brands, product names, service names and trademarks are the property of their respective owners.

19. Contact information

For more information, please visit: <http://www.nxp.com>

For sales office addresses, please send an email to: salesaddresses@nxp.com

20. Contents

1	General description	1	19	Contact information	23
2	Features and benefits	1	20	Contents	24
3	Applications	2			
4	Ordering information	2			
4.1	Ordering options	2			
5	Marking	2			
6	Functional diagram	3			
7	Pinning information	4			
7.1	Pinning	4			
7.2	Pin description	4			
8	Functional description	5			
8.1	EN input	5			
8.2	Fast recovery Reverse-Current Protection (RCP)	5			
8.3	Fast Turn ON	6			
8.4	Under-voltage lock-out	6			
8.5	ILIM	6			
8.6	Main Power FET Overcurrent protection (OCP)	6			
8.6.1	Overcurrent at start-up	7			
8.6.2	Overcurrent when enabled	7			
8.6.3	Short circuit when enabled	7			
8.7	FLT output	7			
8.8	Over-temperature protection	7			
9	Application diagram	8			
10	Limiting values	9			
11	Recommended operating conditions	9			
12	Thermal characteristics	10			
13	Static characteristics	10			
13.1	Graphs	11			
13.2	Thermal shutdown	13			
13.3	ON resistance	14			
13.4	ON resistance graphs	14			
13.5	Current limit	15			
13.6	Current limit graphs	15			
14	Dynamic characteristics	16			
14.1	Waveform and test circuits	16			
15	Package outline	20			
16	Abbreviations	21			
17	Revision history	21			
18	Legal information	22			
18.1	Data sheet status	22			
18.2	Definitions	22			
18.3	Disclaimers	22			
18.4	Trademarks	23			

Please be aware that important notices concerning this document and the product(s) described herein, have been included in section 'Legal information'.

© NXP B.V. 2019.

All rights reserved.

For more information, please visit: <http://www.nxp.com>

For sales office addresses, please send an email to: salesaddresses@nxp.com

Date of release: 7 June 2019

Document identifier: NX5P3290

Looking for pricing, stock, or lifecycle information?

Click below to explore more details on WIN SOURCE:

 [View NX5P3290UKZ on WIN SOURCE](#)

 [NXP / Nexperia Information](#)

Optimize Your Supply Chain with WIN SOURCE Solutions

-  Global Sourcing Solution
-  Obsolete Management
-  Cost Control Management
-  Shortage Management
-  Alternative Solution
-  Excess Inventory Management