

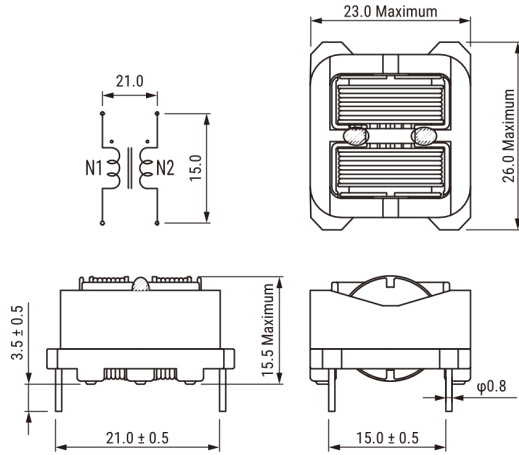

**THE DATASHEET OF
SSHB21H-R07700**





Click [here](#) for the 3D model.

Dimensions

L	26mm MAX
T	23mm MAX
H	15.5mm MAX
LL	3.5mm +/-0.5mm
S	21mm +/-0.5mm
S1	15mm NOM
Wire Size	0.28mm

Packaging Specifications

Packaging	Tray
Packaging Quantity	360
Typical Component Weight	14 g

General Information

Series	SSHB21H
Style	Through-Hole
RoHS	Yes
Notes	Marking: R07 Lot No.
Miscellaneous	Temperature Rise Maximum: 60 K.
Core	Mn-Zn Ferrite

Specifications

Voltage AC	250 VAC, 320 VAC (IEC60664-1)
Inductance	70 mH (10 kHz)
Current	700 mA
Temperature Range	-40/+120°C
DC Resistance	1.16 Ohms (Per Line)

Looking for pricing, stock, or lifecycle information?

Click below to explore more details on WIN SOURCE:

 [View SSHB21H-R07700 on WIN SOURCE](#)

 [Kemet Information](#)

Optimize Your Supply Chain with WIN SOURCE Solutions

-  Global Sourcing Solution
-  Obsolete Management
-  Cost Control Management
-  Shortage Management
-  Alternative Solution
-  Excess Inventory Management