

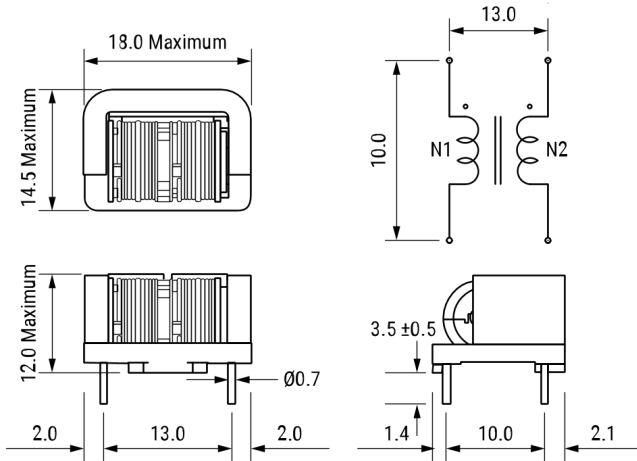

**THE DATASHEET OF
SSRH7HS-M17023**





Click [here](#) for the 3D model.

General Information

Series	SSRH7HS-M
Style	Through-Hole
RoHS	Yes
Notes	M17 Lot No.
Miscellaneous	Temperature Rise Maximum: 50 K.
Core	Mn-Zn Ferrite

Specifications

Voltage AC	250 VAC
Inductance	2.3 mH (10 kHz)
Current	1.7 A
Temperature Range	-40/+120°C
DC Resistance	0.1 Ohms (Per Line)

Dimensions

L	18mm MAX
T	14.5mm MAX
H	12mm MAX
LL	3.5mm +/-0.5mm
S	13mm NOM
SI	10mm NOM
Wire Size	0.7mm

Packaging Specifications

Packaging	Tray
Packaging Quantity	600
Typical Component Weight	4.9 g

Looking for pricing, stock, or lifecycle information?

Click below to explore more details on WIN SOURCE:

 [View SSRH7HS-M17023 on WIN SOURCE](#)

 [Kemet Information](#)

Optimize Your Supply Chain with WIN SOURCE Solutions

-  Global Sourcing Solution
-  Obsolete Management
-  Cost Control Management
-  Shortage Management
-  Alternative Solution
-  Excess Inventory Management