

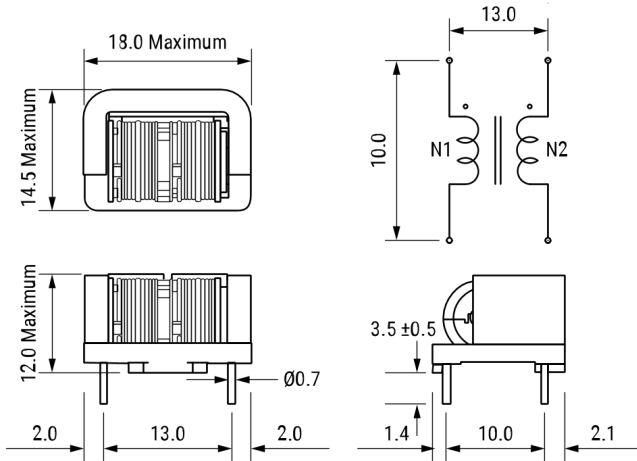

**THE DATASHEET OF
SSRH7HS-M05324**





Click [here](#) for the 3D model.

General Information

Series	SSRH7HS-M
Style	Through-Hole
RoHS	Yes
Notes	M05 Lot No.
Miscellaneous	Temperature Rise Maximum: 50 K.
Core	Mn-Zn Ferrite

Specifications

Voltage AC	250 VAC
Inductance	32.4 mH (10 kHz)
Current	500 mA
Temperature Range	-40/+120°C
DC Resistance	1.21 Ohms (Per Line)

Dimensions

L	18mm MAX
T	14.5mm MAX
H	12mm MAX
LL	3.5mm +/-0.5mm
S	13mm NOM
SI	10mm NOM
Wire Size	0.7mm

Packaging Specifications

Packaging	Tray
Packaging Quantity	600
Typical Component Weight	5.1g

Looking for pricing, stock, or lifecycle information?

Click below to explore more details on WIN SOURCE:

 [View SSRH7HS-M05324 on WIN SOURCE](#)

 [Kemet Information](#)

Optimize Your Supply Chain with WIN SOURCE Solutions

-  Global Sourcing Solution
-  Obsolete Management
-  Cost Control Management
-  Shortage Management
-  Alternative Solution
-  Excess Inventory Management