

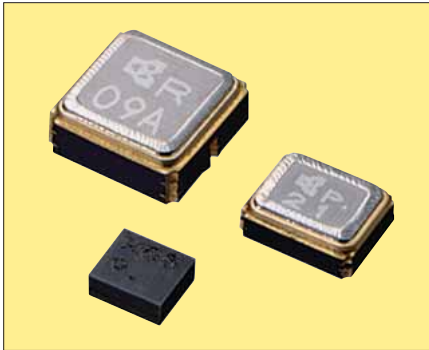

**THE DATASHEET OF
SF25-0881M5UB02**





Pb Free

RoHS Comforming

Features

- Small and low profile
- Low insertion loss
- High Selectivity
- Withstanding High Voltage

Applications

- PCS
- GPS

How to Order

SF 16 - 1575 F 4 UU 01
① ② ③ ④ ⑤ ⑥ ⑦

- ① Series
- ② Package Size
- ③ Frequency
- ④ Application
- ⑤ Terminals
- ⑥ Input/Output Condition
- ⑦ Custom Specification

Dimensions

(Unit : mm)

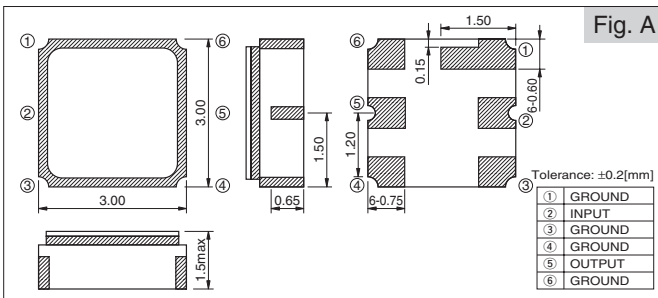

(Unit : mm)

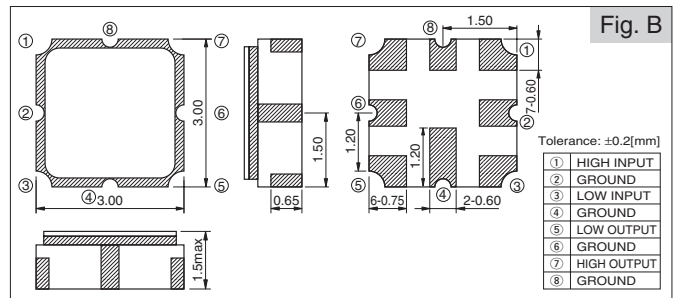

(Unit : mm)

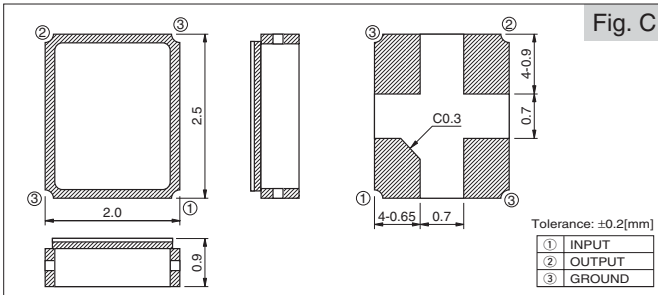

(Unit : mm)

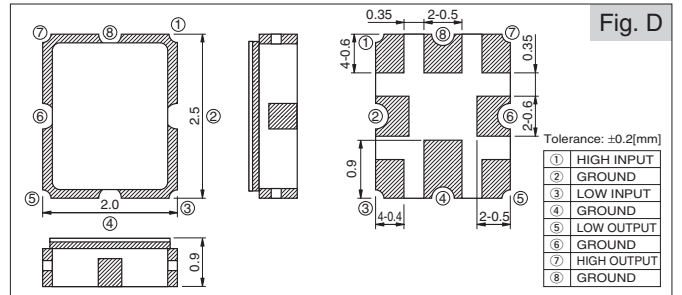

(Unit : mm)

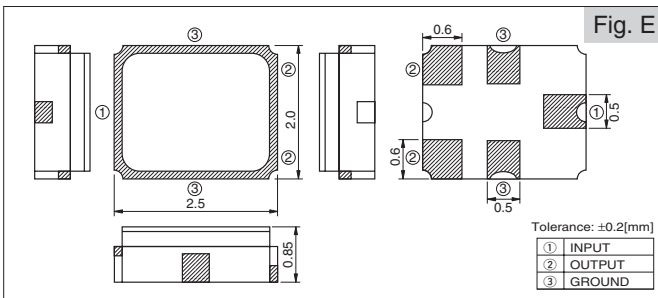

(Unit : mm)

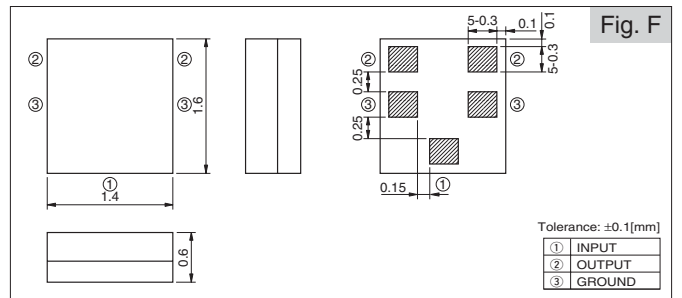

(Unit : mm)

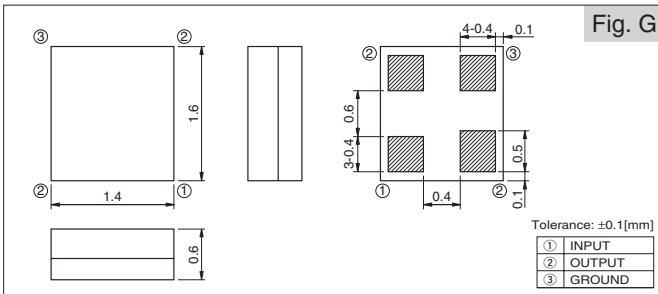

Recommended Land Pattern

(Unit : mm)

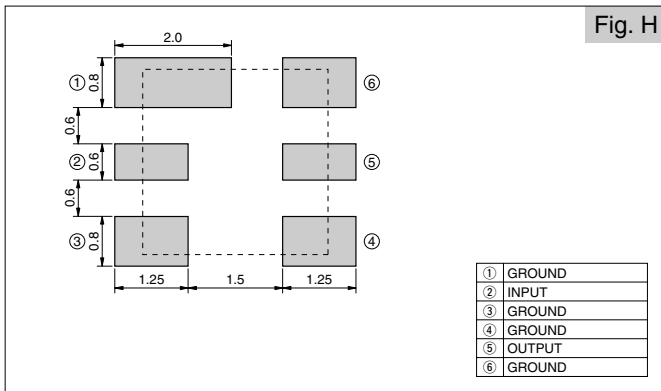

(Unit : mm)

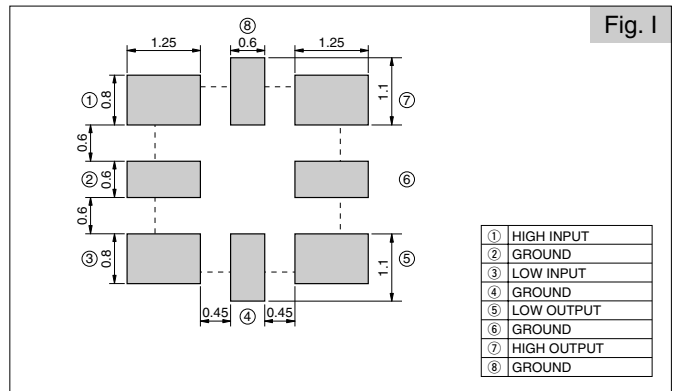

(Unit : mm)

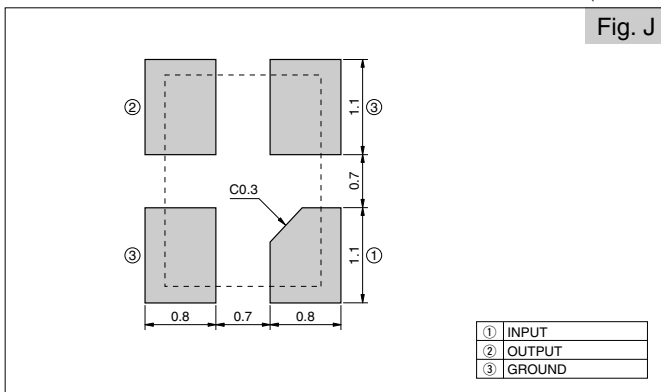

(Unit : mm)

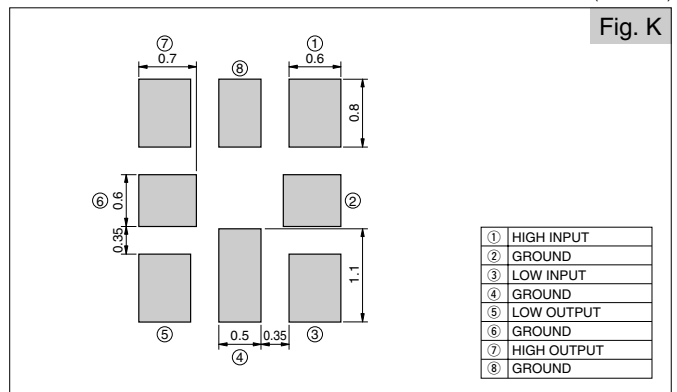

(Unit : mm)

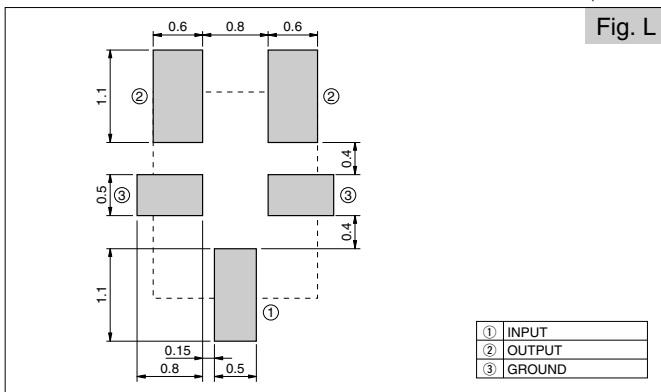

(Unit : mm)

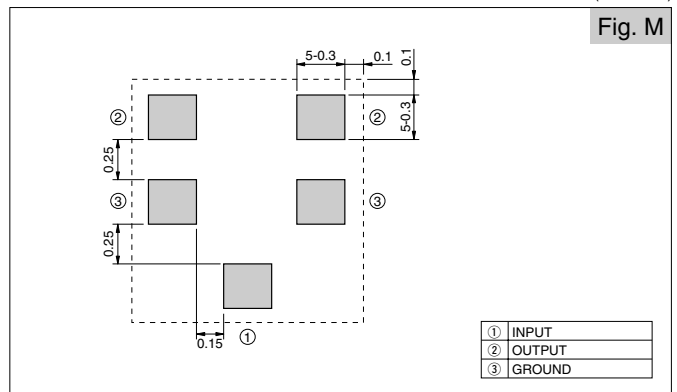

(Unit : mm)

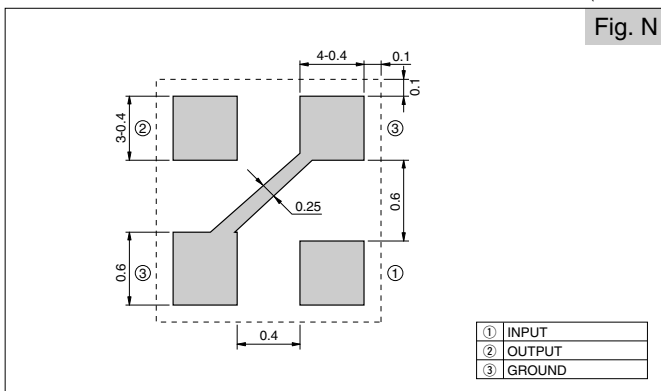

Specifications

Parts No.	Application		Pass Band Frequency	Pass Band Insertion Loss	Pass Band Variation	Pass Band VSWR	Absolute Rejection						Operating Temperature	Storage Temperature	Dimensions	Test Circuit	Recommended Land Pattern	Taping Dimensions				
							0MHz	824MHz	915MHz	960MHz												
SF16-0881M5UB01	Cellular	Differential	869MHz 894MHz	3.0dB max	1.5dB max	2.5 max	0MHz	824MHz	915MHz	960MHz			-30 to +85 °C	-40 to +85 °C	Fig. F	Fig. R	Fig. M	Dimensions 4				
							824MHz	849MHz	960MHz	3000MHz												
							35dB min	30dB min	23dB min	40dB min												
SF16-1575F4UU01	GPS	Front End	1573.92MHz 1576.92MHz	1.8dB max	1.0dB max	2.0 max	810MHz	1429MHz	1893MHz			-30 to +85 °C	-40 to +85 °C	Fig. G	Fig. Q	Fig. N	Dimensions 4					
							960MHz	1501MHz	2170MHz													
							27dB min	37dB min	35dB min													
SF16-1575M4UU01	GPS	Inter Stage	1573.92MHz 1576.92MHz	1.8dB max	1.0dB max	2.5 max	810MHz	1208.22MHz	1207MHz	1522.42MHz	1628.42MHz	1850MHz	-30 to +85 °C	-40 to +85 °C	Fig. G	Fig. Q	Fig. N	Dimensions 4				
							960MHz	1210MHz	1210MHz													
							35dB min	45dB min	45dB min	25dB min	35dB min	30dB min										
SF16-1960M5UB01	PCS	Differential	1930MHz 1990MHz	4.1dB max	2.0dB max	2.5 max	0MHz	1850MHz	2040MHz	2200MHz	2800MHz	3400MHz	-30 to +85 °C	-40 to +85 °C	Fig. F	Fig. R	Fig. M	Dimensions 4				
							1850MHz	1910MHz	2200MHz	2800MHz	3400MHz	6000MHz										
							30dB min	15dB min	25dB min	30dB min	30dB min	20dB min										
SF25-0881M5UB02	Cellular	Differential	869MHz 894MHz	3.0dB max	1.5dB max	2.5 max	0MHz	824MHz	915MHz	960MHz			-30 to +85 °C	-40 to +85 °C	Fig. E	Fig. R	Fig. L	Dimensions 3				
							824MHz	849MHz	960MHz	3000MHz												
							35dB min	30dB min	23dB min	40dB min												
SF25-1575F4UU01	GPS Single	Front End	1573.92MHz 1576.92MHz	1.8dB max	1.0dB max	2.0 max	810MHz	1429MHz	1893MHz			-30 to +85 °C	-40 to +85 °C	Fig. C	Fig. Q	Fig. J	Dimensions 3					
							960MHz	1501MHz	2170MHz													
							27dB min	37dB min	35dB min													
SF25-1575M5UB01	GPS	Differential	1573.92MHz 1576.92MHz	1.8dB max	0.7dB max	2.5 max	0MHz	1475MHz	1625MHz	1675MHz	3155MHz		-30 to +85 °C	-40 to +85 °C	Fig. E	Fig. R	Fig. L	Dimensions 3				
							1475MHz	1525MHz	1675MHz	3155MHz	6000MHz											
							30dB min	10dB min	10dB min	30dB min	20dB min											
SF25-1575S4UU01	GPS Single	Inter Stage	1573.92MHz 1576.92MHz	3.0dB max	1.0dB max	2.0 max	810MHz	1429MHz	1895MHz			-30 to +85 °C	-40 to +85 °C	Fig. C	Fig. Q	Fig. J	Dimensions 3					
							960MHz	1501MHz	1916MHz													
							45dB min	40dB min	35dB min													
SF25-1880H8UU00	PCS (Half)	Tx(Low)	1850MHz 1880MHz	2.2dB max	1.5dB max	2.0 max	0MHz	1700MHz	1770MHz	1930MHz	2040MHz	2100MHz	-30 to +85 °C	-40 to +85 °C	Fig. D	Fig. P	Fig. K	Dimensions 3				
		Tx(High)	1880MHz 1910MHz	2.2dB max	1.5dB max	2.0 max	0MHz	1700MHz	1800MHz	1960MHz	2040MHz	2100MHz										
SF25-1960M5UB01	PCS	Differential	1930MHz 1990MHz	4.1dB max	2.0dB max	2.5 max	0MHz	1850MHz	2040MHz	2200MHz	2800MHz	3400MHz	-30 to +85 °C	-40 to +85 °C	Fig. E	Fig. R	Fig. L	Dimensions 3				
							1850MHz	1910MHz	2200MHz	2800MHz	3400MHz	6000MHz										
							30dB min	15dB min	25dB min	30dB min	30dB min	20dB min										
SF30-1575F6UU03	GPS Single	Front End	1573.92MHz 1576.92MHz	1.8dB max	1.0dB max	2.0 max	810MHz	1429MHz	1687MHz	1893MHz	1920MHz	2450MHz	-30 to +85 °C	-40 to +85 °C	Fig. A	Fig. O	Fig. H	Dimensions 1				
							958MHz	1501MHz	25dB min	25dB min	25dB min	18dB min										
							25dB min	25dB min	25dB min	25dB min	25dB min	18dB min										
SF30-1575S6UU03	GPS Single	Inter Stage	1573.92MHz 1576.92MHz	3.0dB max	1.0dB max	2.0 max	DC	810MHz	1429MHz	1701MHz	1893MHz	1920MHz	-30 to +85 °C	-40 to +85 °C	Fig. A	Fig. O	Fig. H	Dimensions 1				
								810MHz	958MHz	1501MHz	1920MHz	3000MHz										
							25dB min	45dB min	40dB min	45dB min	40dB min	30dB min										
SF30-1880M6UU00	PCS	Tx	1850MHz 1910MHz	4.5dB max	2.8dB max	2.5 max	1590MHz	1720MHz	1930MHz	3400MHz			-30 to +85 °C	-40 to +85 °C	Fig. A	Fig. O	Fig. H	Dimensions 1				
							1650MHz	1780MHz	1990MHz	4800MHz												
							20dB min	20dB min	7dB min	15dB min												
SF30-1880H8UU00	PCS (Half)	Tx(Low)	1850MHz 1880MHz	3.0dB max	1.7dB max	2.3 max	0	1700MHz	1930MHz	2200MHz	2700MHz		-30 to +85 °C	-40 to +85 °C	Fig. B	Fig. P	Fig. I	Dimensions 1				
		Tx(High)	1880MHz 1910MHz	3.0dB max	1.7dB max	2.3 max	0	1700MHz	1960MHz	2200MHz	2700MHz											
SF30-1960M6UU00	PCS	Rx	1930MHz 1990MHz	4.0dB max	2.8dB max	2.0 max	1509MHz	1850MHz	2100MHz	3400MHz			-30 to +85 °C	-40 to +85 °C	Fig. A	Fig. O	Fig. H	Dimensions 1				
							1780MHz	1910MHz	2375MHz	4350MHz												
							20dB min	10dB min	24dB min	10dB min												

Characteristics

<GPS Single Front End>Parts No. : SF16-1575F4UU01

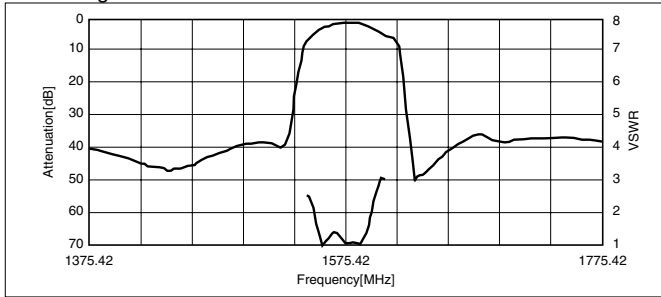

Pass Band Characteristics

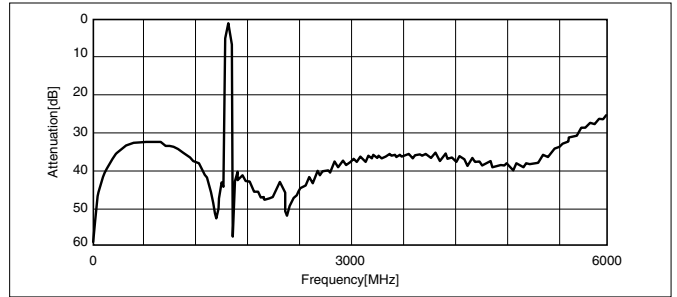

Spurious Characteristics

<GPS Single Inter Stage>Parts No. : SF16-1575M4UU01

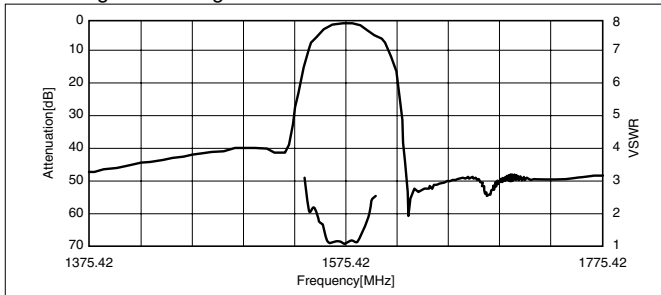

Pass Band Characteristics

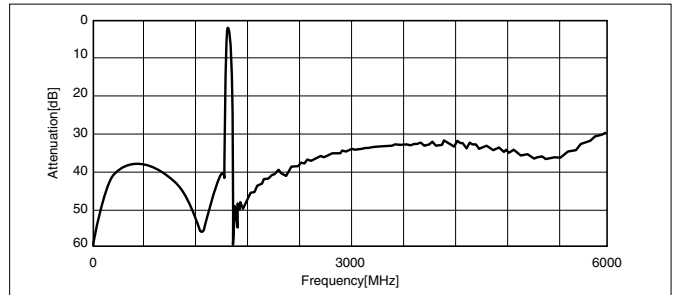

Spurious Characteristics

<GPS Single Front End>Parts No. : SF25-1575F4UU00

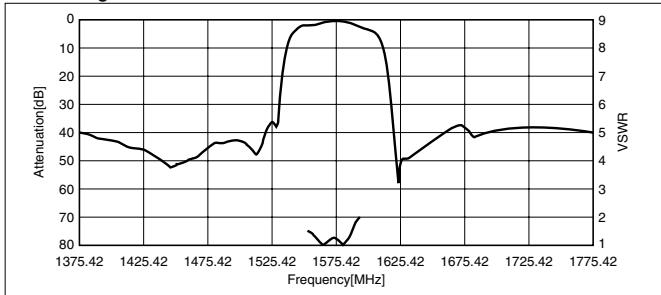

Pass Band Characteristics

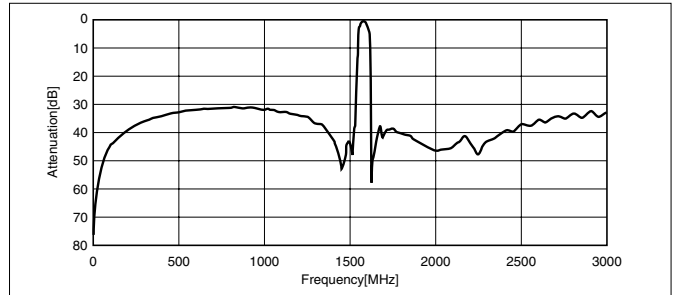

Spurious Characteristics

<GPS Single Inter Stage>Parts No. : SF25-1575S4UU00

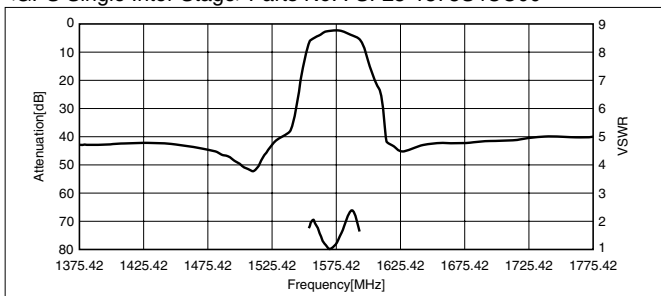

Pass Band Characteristics

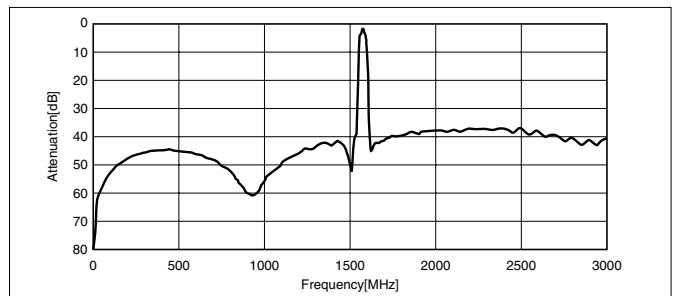

Spurious Characteristics

Characteristics

<Cellular Rx>Parts No. : SF16-0881M5UB01

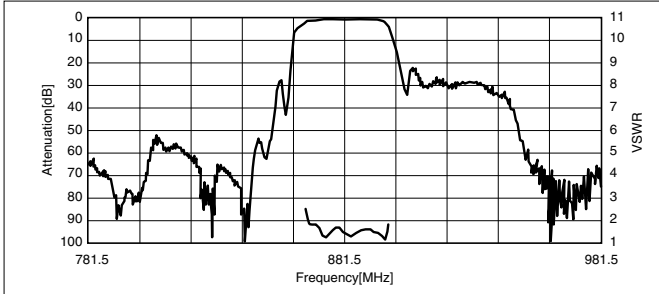

Pass Band Characteristics

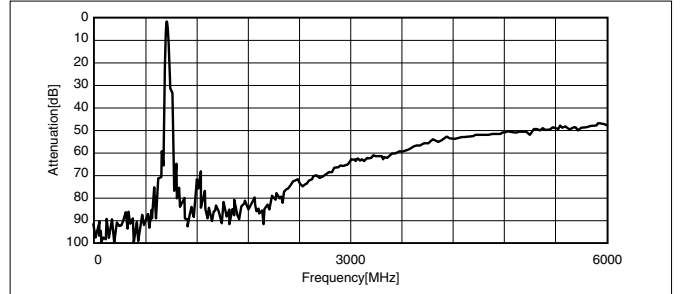

Spurious Characteristics

<PCS Rx>Parts No. : SF16-1960M5UB01

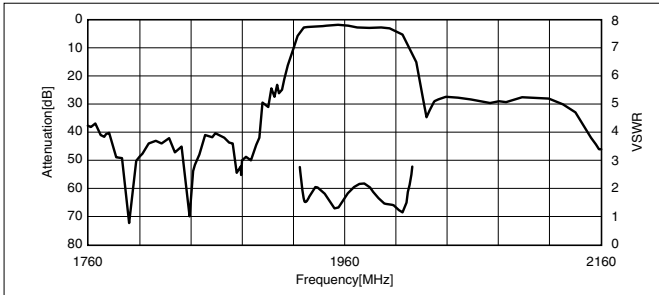

Pass Band Characteristics

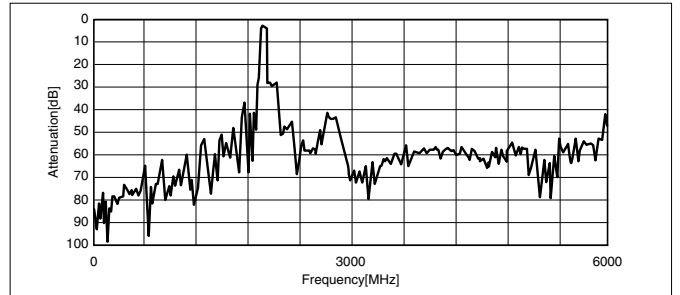

Spurious Characteristics

Test Circuit

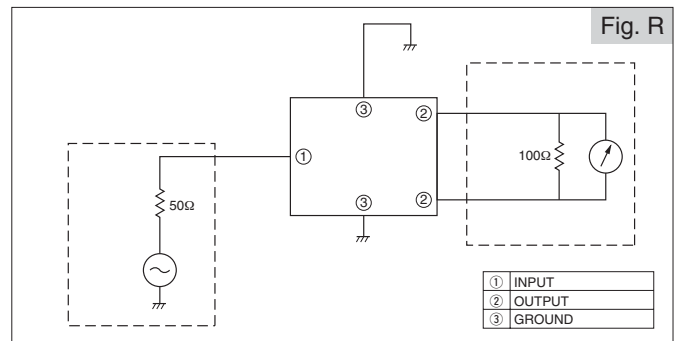
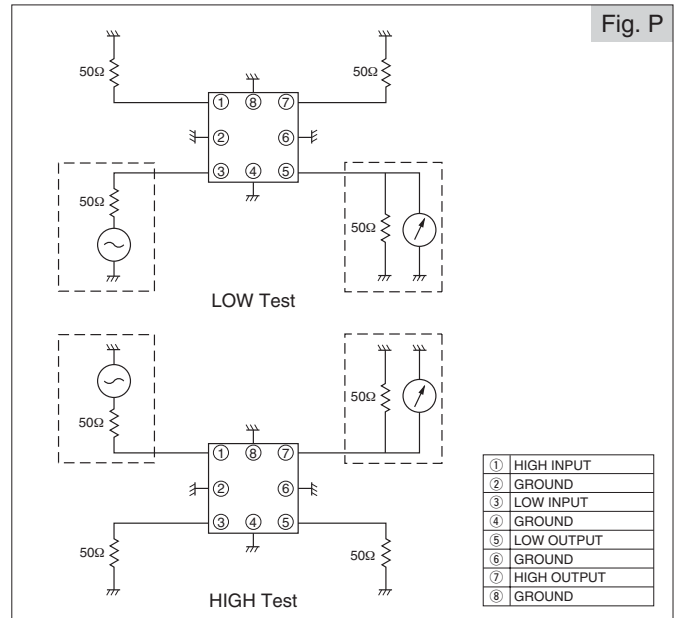
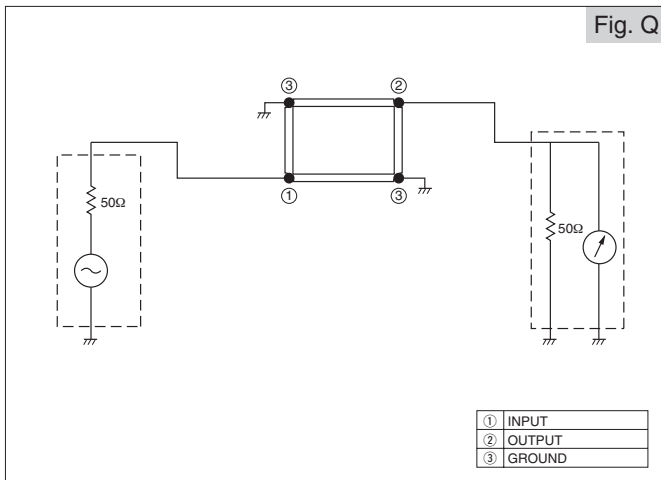
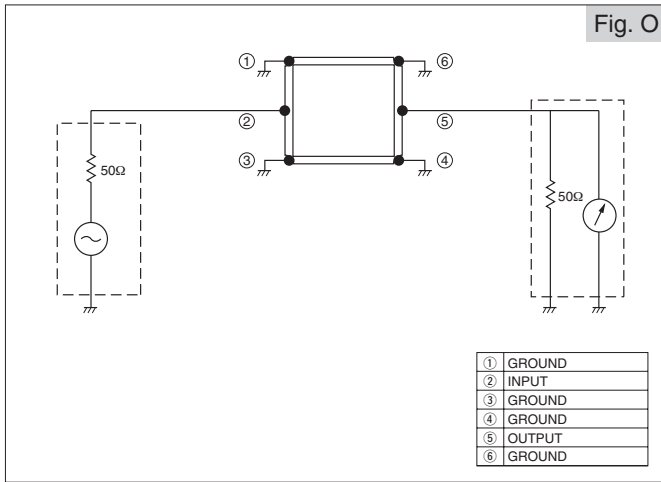

Recommended Temperature Profile IR Reflow

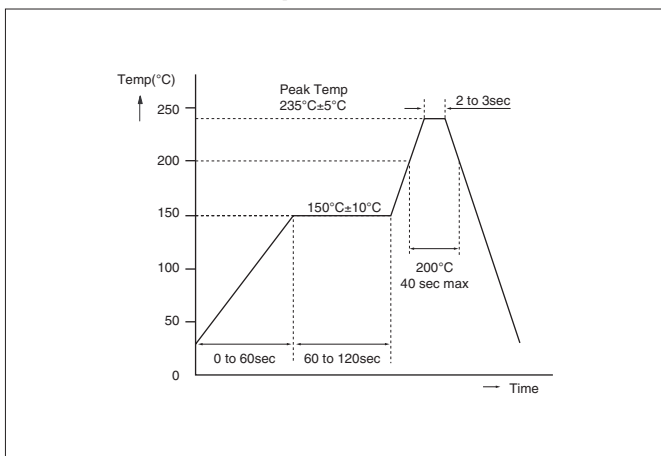

Taping Dimensions

(Unit : mm)

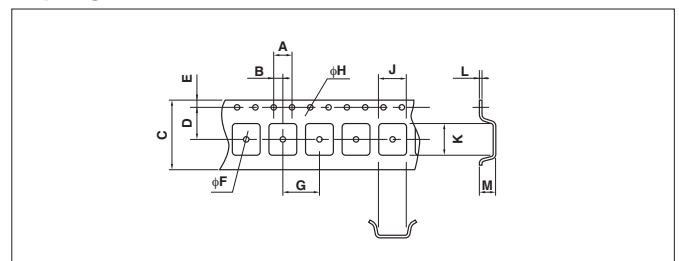

Code	A	B	C	D	F	G	H	J	K	L	M
Dimensions1	4.0	2.0	12.0	5.5	1.55	8.0	1.55	3.3	3.3	0.3	1.85
Dimensions2	4.0	2.0	12.0	5.5	1.55	8.0	1.55	4.0	4.0	0.3	1.40
Dimensions3	4.0	2.0	12.0	5.5	1.10	4.0	1.55	2.4	2.9	0.3	1.20
Dimensions4	4.0	2.0	8.0	3.5	1.10	4.0	1.50	1.7	1.8	0.25	0.85

Characteristic diagram and terms of crystal filters

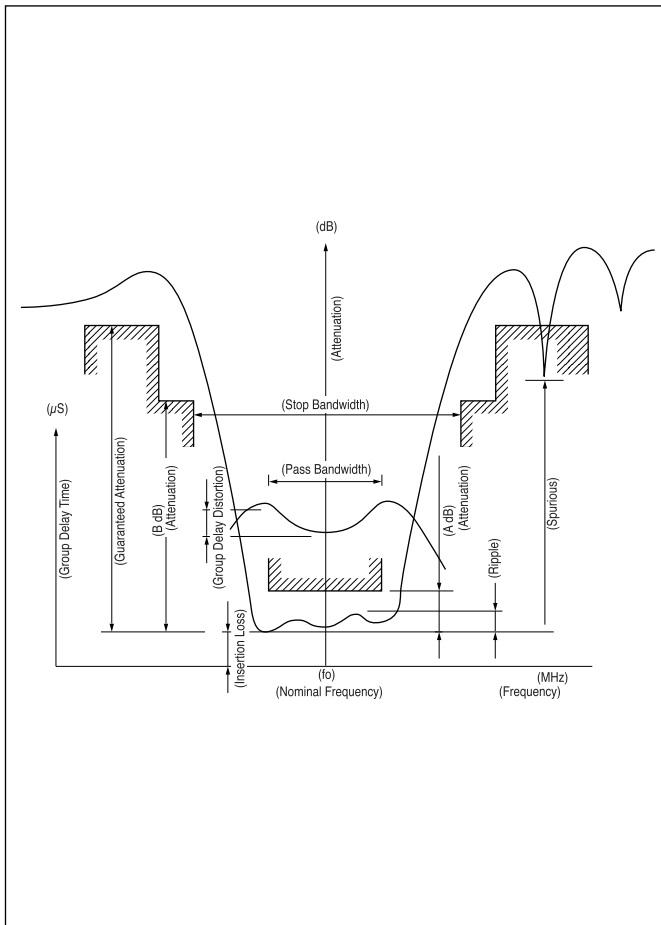

■Nominal Frequency

This is the nominal value of the center frequency (f_0) and is used as the reference frequency of related standards.

■Pass Bandwidth

This is the frequency interval in which the relative attenuation (the attenuation from the minimum insertion loss) is equal to the specified value "A dB" (Usually 3dB).

■Insertion Loss

This is the difference of attenuation when a filter is and isn't inserted. The minimum insertion loss is the minimum value of insertion loss and becomes as the reference level of attenuation characteristics specification. The constant loss is the insertion loss at the nominal frequency.

■Ripple

This is the maximum value of the difference between the peak value of attenuation in the pass band and the minimum insertion loss.

■Stop Bandwidth

This is the frequency interval in which the relative attenuation is equal to the specified value "B dB".

■Guaranteed Attenuation

This is the relative attenuation guaranteed in the specified range within attenuation band scope.

■Spurious Response

This is the value of relative attenuation generated by the secondary vibration in the specified range within attenuation band scope.

■Group Delay Time

This is the difference between the maximum and the minimum value of the group delay in the specified range of the pass band.

■Terminating Impedance

This is the impedance value terminated to the input and the output side of filter and is indicated by the resistance portion and the parallel capacity portion including the floating capacity.

ORDERING FORMAT for CRYSTAL FILTERS

Please specify the following items when ordering crystal filters.

I. Standard product in catalog Indicate type name.

for example : MXF10.7-6A

II. Indicate following items in specification if you order special type.

1. Electrical Characteristics

- | | |
|---------------------------|-------------------------------------|
| (1)Nominal Frequency | _____MHz |
| (2)Pass Bandwidth | at_____dB ±_____kHz MIN. |
| (3)Stop Bandwidth | at_____dB ±_____kHz MAX. |
| (4)Guaranteed Attenuation | _____dB MINn. ($f_0 \pm$ _____kHz) |
| (5)Spurious Response | _____dB MIN. |
| (6)Ripple | _____dB MAX. |
| (7)Insertion Loss | _____dB MAX. |
| (8)Terminating Impedance | _____Ω//_____pF |

2. Environmental Condition

- (1)Operating Temperature Range _____°C ~ _____°C

3. Dimensions _____

4. Application _____

Tape & Reel Specifications

SAW FILTERS / MCFs

		SAW FILTERS			
		SF16	SF25	SF30	
T A P E	A	2.0±0.05	2.0±0.05	2.0±0.05	
	B	4.0±0.1	4.0±0.1	4.0±0.1	
	C	φ1.5±0.1	φ1.55±0.1/-0	φ1.55±0.1/-0	
	D	4.0±0.1	4.0±0.1	8.0±0.1	
	E	3.5±0.05	5.5±0.05	5.5±0.05	
	F	1.75±0.1	1.75±0.1	1.75±0.1	
	G	8.0±0.2	12.0±0.2	12.0±0.2	
	H	φ1.1±0.1	φ1.1±0.1	φ1.55±0.1	
	J	1.9±0.1	2.9±0.1	3.3±0.1	
	L	1.85±0.1	2.4±0.1	3.3±0.1	
	N	0.95±0.1	1.2±0.1	1.85±0.1	
	O	0.25±0.05	0.3±0.05	0.3±0.05	
	R E E L	P	φ178±2	φ330±2	φ330±2
		Q	φ80±2	φ100±2	φ100±2
R		φ13±0.2	φ13±0.2	φ13±0.2	
S		φ21±0.8	φ21±0.8	φ21±0.8	
U		2±0.5	2±0.5	2±0.5	
W		13.5±1	13.5±1	13.5±1	
Qty		3000	3000	3000	

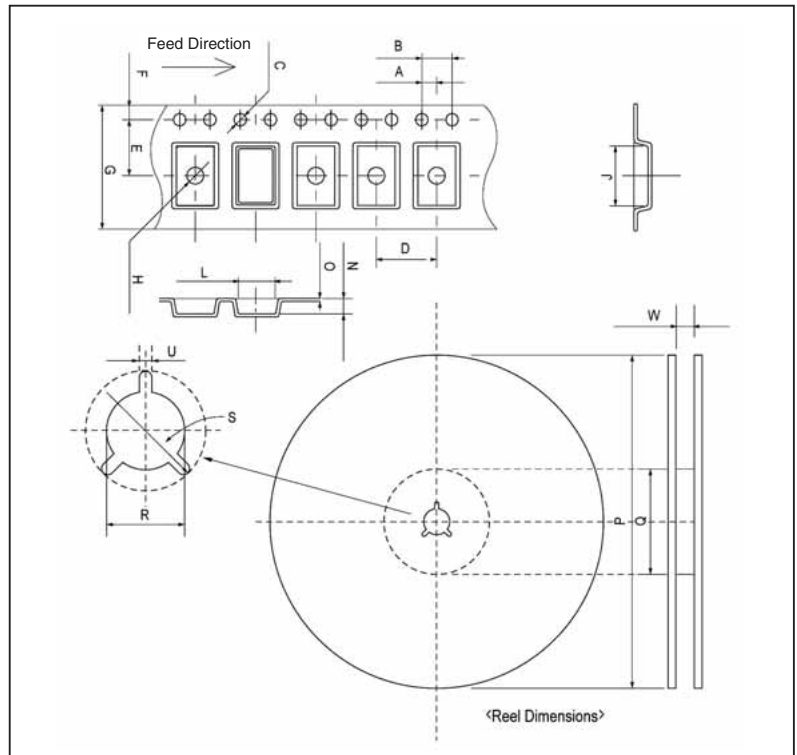

		SAW FILTERS								MCF	
		PAFA	PAFC243B	PAFC433.92A	B54	B22 B43	B19 B25	C12 C30	B44	FP2 FP4	
T A P E	A	2.0±0.05	2.0±0.05	2.0±0.05	2.0±0.10	2.0±0.10	2.0±0.05	2.0±0.10	2.0±0.10	2.0±0.1	
	B	4.0±0.1	4.0±0.1	4.0±0.1	4.0±0.1	4.0±0.1	4.0±0.1	4.0±0.1	4.0±0.1	4.0±0.1	
	C	φ1.55±0.05	φ1.5±0.1/-0	φ1.5±0.1/-0	φ1.55±0.05	φ1.55±0.05	φ1.55±0.05	φ1.55±0.05	φ1.55±0.05	φ1.55±0.05	
	D	8.0±0.1	8.0±0.1	8.0±0.1	8.0±0.1	8.0±0.1	8.0±0.1	8.0±0.1	8.0±0.1	8.0±0.1	
	E	5.5±0.05	5.5±0.05	5.5±0.05	5.5±0.1	7.5±0.1	5.5±0.05	7.5±0.1	5.5±0.05	7.5±0.1	
	F	1.75±0.1	1.75±0.1	1.75±0.1	1.75±0.1	1.75±0.1	1.75±0.1	1.75±0.1	1.75±0.1	1.75±0.1	
	G	12.0±0.2	12.0±0.2	12.0±0.3	12.0±0.3	16.0±0.3	12.0±0.15	16.0±0.3	12.0±0.2	16.0±0.3	
	H	φ1.55±0.05	φ1.55±0.1	φ1.55±0.1	φ1.5±0.05/-0	φ1.55±0.05	φ1.55±0.05	φ1.55±0.05	φ1.55±0.05	φ1.55±0.05	
	J	3.3±0.1	4.3±0.1	5.3±0.1	5.25±0.1	9.4±0.1	4.2±0.1	7.6±0.1	3.95±0.2	7.5±0.1	
	L	3.3±0.1	4.3±0.1	5.3±0.1	3.45±0.1	5.1±0.1	4.2±0.1	5.6±0.1	3.95±0.2	5.5±0.1	
	N	1.85±0.1	2.05±0.1	2.1±0.1	1.5±0.1/-0	2.0±0.1	1.8±0.1	1.94±0.1	1.35±0.1	1.8±0.1	
	O	0.3±0.05	0.3±0.05	0.3±0.05	0.3±0.1	0.3±0.05	0.3±0.05	0.3±0.05	0.2±0.05	0.3±0.05	
	R E E L	P	φ255±2	φ255±2	φ255±2	φ330±1	φ330±1	φ178±2	φ330±1	φ178±2	φ178±2
		Q	φ100±2	φ80±2	φ80±2	φ100±1	φ100±1	φ80±1	φ100±1	φ80±1	φ80±2
R		φ13±0.2	φ13±0.2	φ13±0.2	φ13±0.3	φ13±0.3	φ13±0.5	φ13±0.3	φ13±0.5	φ13±0.5	
S		φ21±0.8	φ21±0.8	φ21±0.8	φ21±0.5	φ21±0.5	φ21±0.5	φ21±0.5	φ21±0.5	φ21±0.8	
U		2±0.5	2±0.5	2±0.5	2±0.5	2±0.5	2±0.5	2±0.5	2±0.5	2±0.5	
W		13.5±1	13.5±1	13.5±1	12.4±2/-0	16.4±0.5	13.5±2/-0	16.4±0.5	13.5±2/-0	17.5±1/-0.5	
Qty		2000	2000	2000	3000	3000	1000	3000	1000	1000	

Looking for pricing, stock, or lifecycle information?

Click below to explore more details on WIN SOURCE:

-  [View SF25-0881M5UB02 on WIN SOURCE](#)
-  [AVX Corp/Kyocera Corp Information](#)

Optimize Your Supply Chain with WIN SOURCE Solutions

-  Global Sourcing Solution
-  Obsolete Management
-  Cost Control Management
-  Shortage Management
-  Alternative Solution
-  Excess Inventory Management