



**THE DATASHEET OF  
SF2176E**



- Low-loss RF SAW Filter
- Surface-mount 3.0 x 3.0 x 1.3 mm Package
- Complies with Directive 2002/95/EC (RoHS)
- Complies with AEC-Q200



**Absolute Maximum Ratings**

Rating	Value	Units
Input Power Level	10	dBm
DC Voltage on any Non-ground Terminal	3	V
Operating Temperature Range	-40 to +105	°C
Storage Temperature Range in Tape and Reel	-40 to +85	°C
Usable Temperature Range	-40 to 125	°C
Solder Reflow Temperature, 10 seconds, 5 cycles maximum	260	°C

**SF2176E**

**433.92 MHz  
SAW Filter**

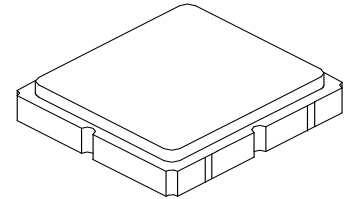

**SM3030-6**

**Electrical Characteristics -40 to +85°C**

Characteristic	Sym	Notes	Min	Typ	Max	Units
Center Frequency	$F_C$			433.92		MHz
Maximum Insertion Loss, 433.12 to 434.72 MHz	$IL_{MAX}$			2.2	2.9	dB
Amplitude Ripple, 433.12 to 434.72 MHz				0.4	1.0	dB <sub>P-P</sub>
VSWR, 433.12 to 434.72 MHz				1.6	2.0	
Attenuation Referenced to 0 dB:						
10.00 to 380.00 MHz			58	61		dB
380.00 to 423.42MHz			46	50		
443.42 to 453.42 MHz			25	30		
453.42 to 460.00 MHz			35	40		
460.00 to 700.00 MHz			50	54		
700.00 to 1000.00 MHz			42	46		
Source Impedance	$Z_S$			50		Ω
Load Impedance	$Z_L$			50		
Case Style	SM3030-6 3.0 x 3.0 mm Nominal Footprint					
Lid Symbolization (Y=year, WW=week, S=shift) dot=pin 1 indicator	A09, YWWS					
Standard Reel Quantity	Reel Size 7 Inch					500 Pieces/Reel
	Reel Size 13 Inch					3000 Pieces/Reel



**CAUTION: Electrostatic Sensitive Device. Observe precautions for handling.**

**NOTES:**

1. Unless noted otherwise, all specifications apply over the operating temperature range with filter soldered to the specified demonstration board with impedance matching to 50 Ω and measured with 50 Ω network analyzer.
2. Unless noted otherwise, all frequency specifications are referenced to the nominal center frequency,  $f_c$ .
3. Rejection is measured as attenuation below the minimum IL point in the passband. Rejection in final user application is dependent on PCB layout and external impedance matching design. See Application Note No. 42 for details.
4. "LRIP" or "L" after the part number indicates "low rate initial production" and "ENG" or "E" indicates "engineering prototypes."
5. The design, manufacturing process, and specifications of this filter are subject to change.
6. Either Port 1 or Port 2 may be used for either input or output in the design. However, impedances and impedance matching may vary between Port 1 and Port 2, so that the filter must always be installed in one direction per the circuit design.
7. US and international patents may apply.
8. Murata, stylized Murata logo, and Murata N.A., Inc. are registered trademarks of Murata Manufacturing Co., Ltd.

**Electrical Characteristics**      **-40 to +105°C**

Characteristic	Sym	Notes	Min	Typ	Max	Units
Center Frequency	$F_C$			433.92		MHz
Maximum Insertion Loss, 433.12 to 434.72 MHz	$IL_{MAX}$			2.2	3.2	dB
Amplitude Ripple, 433.12 to 434.72 MHz				0.4	1.4	dB <sub>P-P</sub>
VSWR, S11 S22				1.6	2.0	
Attenuation Referenced to 0 dB:						
10.00 to 380.00 MHz			58	61		dB
380.00 to 423.42MHz			46	50		
443.42 to 453.42 MHz			12	30		
453.42 to 460.00 MHz			35	40		
460.00 to 700.00 MHz			50	54		
700.00 to 1000.00 MHz			42	46		
Source Impedance	$Z_S$			50		$\Omega$
Load Impedance	$Z_L$			50		
Case Style	SM3030-6 3.0 x 3.0 mm Nominal Footprint					
Lid Symbolization (Y=year, WW=week, S=shift) dot=pin 1 indicator	A09, YWWS					
Standard Reel Quantity	Reel Size 7 Inch					500 Pieces/Reel
	Reel Size 13 Inch					3000 Pieces/Reel



**CAUTION: Electrostatic Sensitive Device. Observe precautions for handling.**

**Notes:**

1. Unless noted otherwise, all specifications apply over the operating temperature range with filter soldered to the specified demonstration board with impedance matching to 50  $\Omega$  and measured with 50  $\Omega$  network analyzer.
2. Unless noted otherwise, all frequency specifications are referenced to the nominal center frequency, fc.
3. Rejection is measured as attenuation below the minimum IL point in the passband. Rejection in final user application is dependent on PCB layout and external impedance matching design. See Application Note No. 42 for details.
4. "LRIP" or "L" after the part number indicates "low rate initial production" and "ENG" or "E" indicates "engineering prototypes."
5. The design, manufacturing process, and specifications of this filter are subject to change.
6. Either Port 1 or Port 2 may be used for either input or output in the design. However, impedances and impedance matching may vary between Port 1 and Port 2, so that the filter must always be installed in one direction per the circuit design.
7. US and international patents may apply.
8. RFM, stylized RFM logo, and RF Monolithics, Inc. are registered trademarks of RF Monolithics, Inc

**Filter Test Circuit**

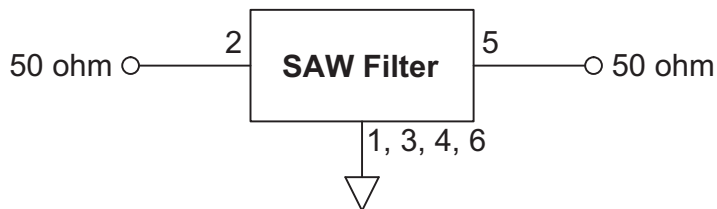

Connection	Terminals
Input	2
Output	5
Ground	All Others

# Filter Response Plots

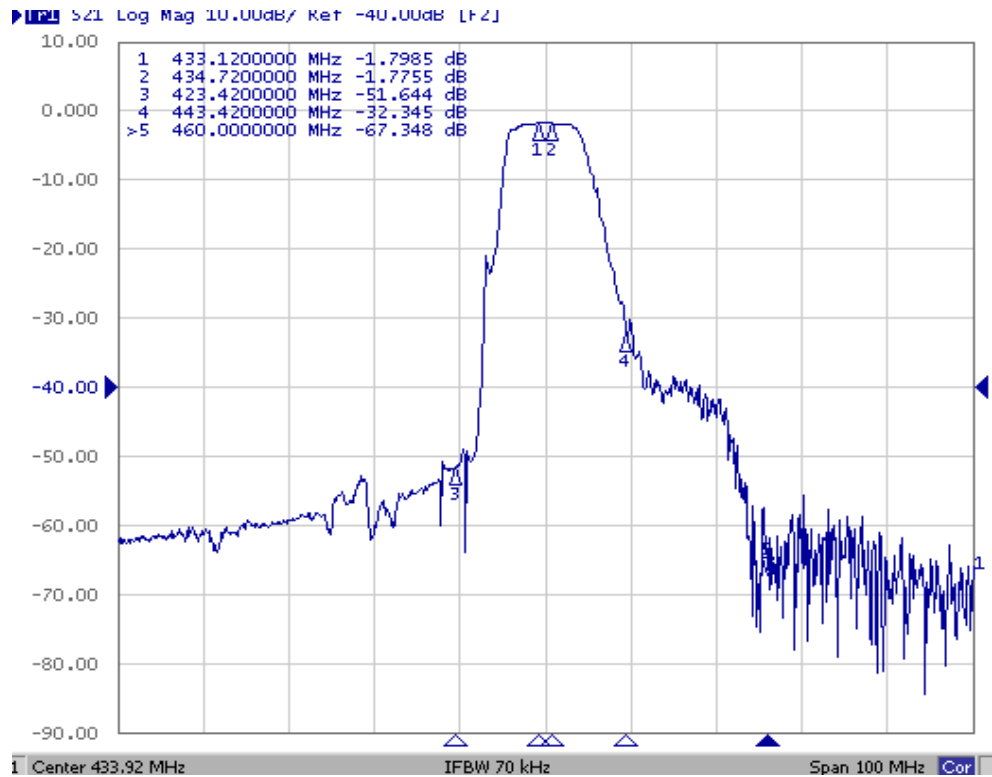
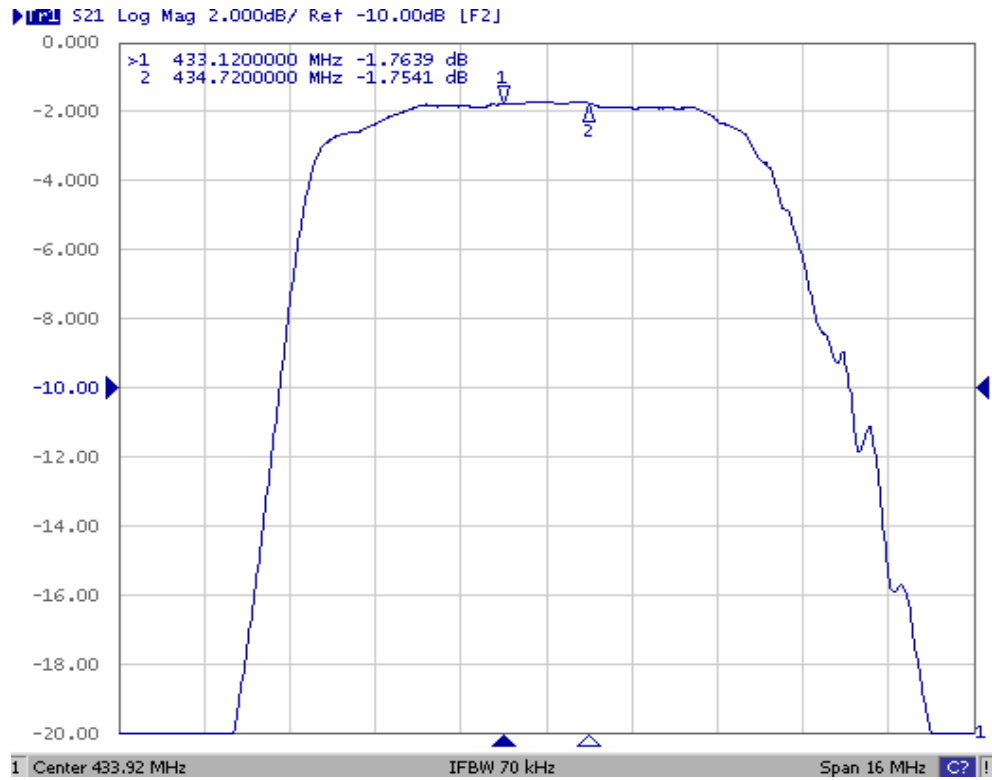

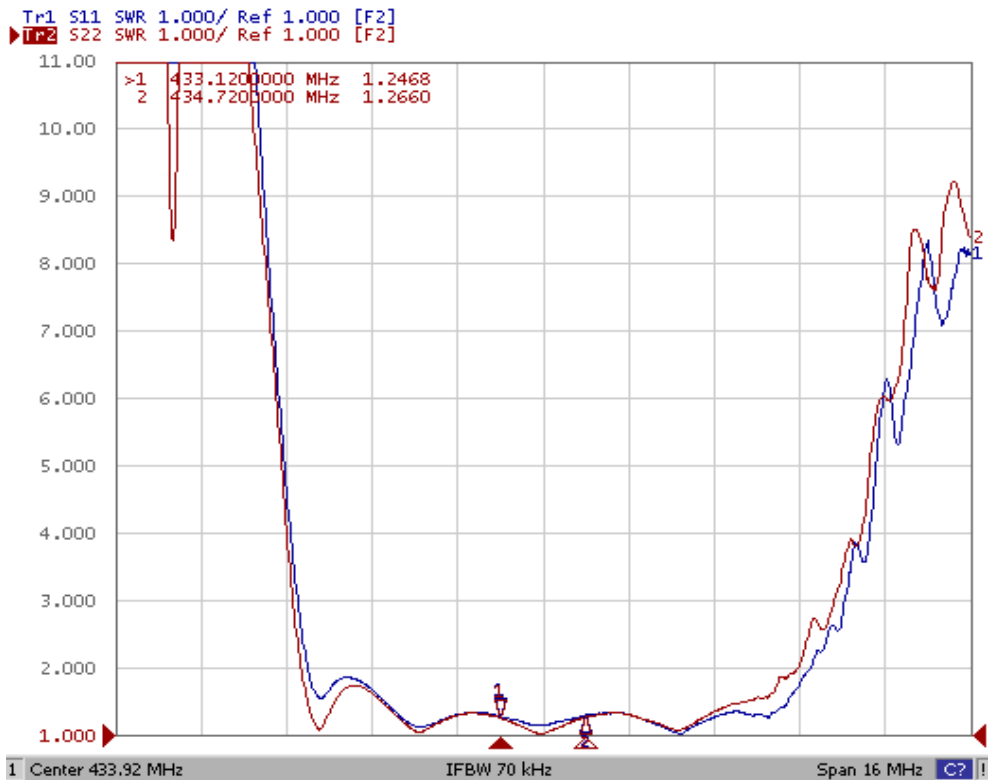
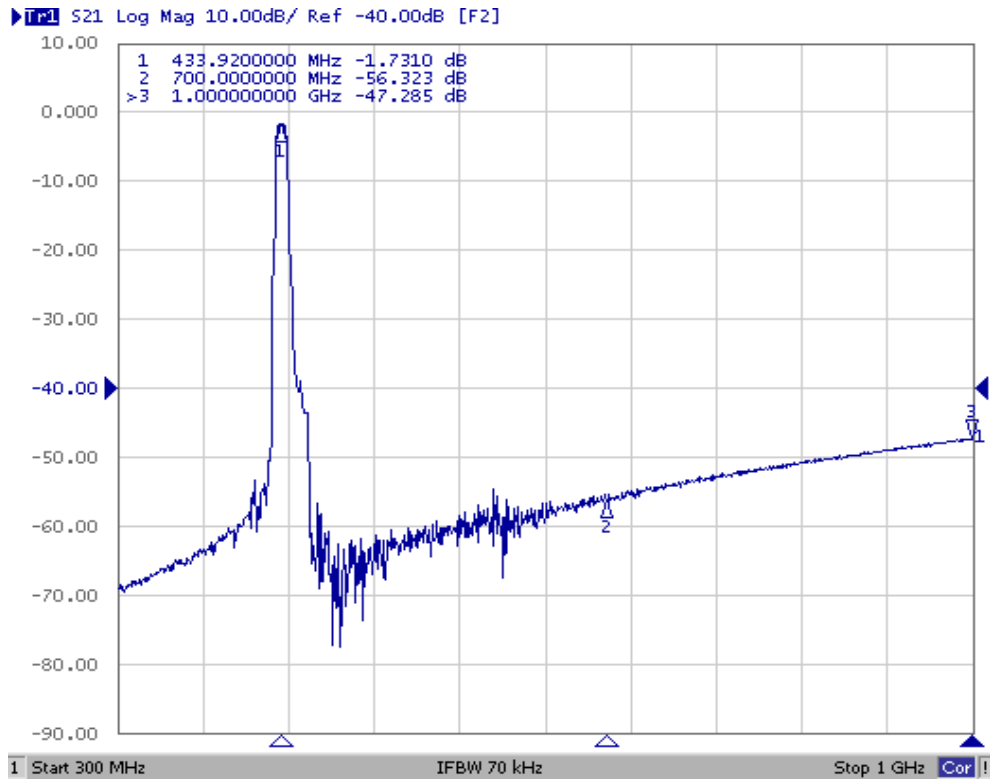

# SM3030-6 Case

## 6-Terminal Ceramic Surface-Mount Case 3.0 X 3.0 mm Nominal Footprint

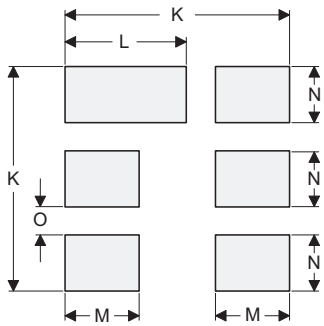
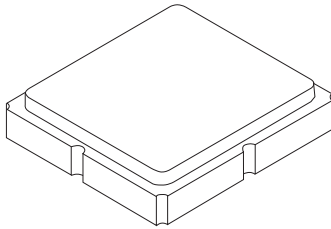

PCB Footprint Top View

### Case and PCB Footprint Dimensions

Dimension	mm			Inches		
	Min	Nom	Max	Min	Nom	Max
A	2.87	3.00	3.13	0.113	0.118	0.123
B	2.87	3.00	3.13	0.113	0.118	0.123
C	1.12	1.25	1.38	0.044	0.049	0.054
D	0.77	0.90	1.03	0.030	0.035	0.040
E	2.67	2.80	2.93	0.105	0.110	0.115
F	1.47	1.60	1.73	0.058	0.063	0.068
G	0.72	0.85	0.98	0.028	0.033	0.038
H	1.37	1.50	1.63	0.054	0.059	0.064
I	0.47	0.60	0.73	0.019	0.024	0.029
J	1.17	1.30	1.43	0.046	0.051	0.056
K		3.20			0.126	
L		1.70			0.067	
M		1.05			0.041	
N		0.81			0.032	
O		0.38			0.015	

### Case Materials

Materials	
Solder Pad Plating	0.3 to 1.0 $\mu\text{m}$ Gold over 1.27 to 8.89 $\mu\text{m}$ Nickel
Lid Plating	2.0 to 3.0 $\mu\text{m}$ Nickel
Body	$\text{Al}_2\text{O}_3$ Ceramic
Pb Free	

### TOP VIEW

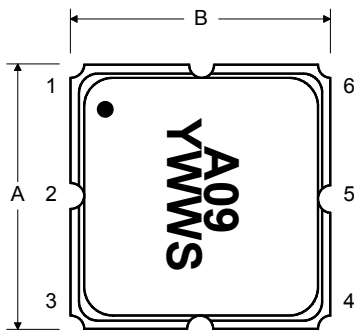

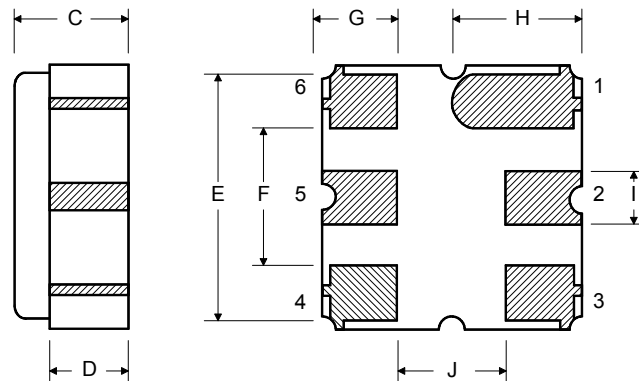

### BOTTOM VIEW





## Looking for pricing, stock, or lifecycle information?

Click below to explore more details on WIN SOURCE:

-  [View SF2176E on WIN SOURCE](#)
-  [Murata Electronics North America Information](#)

## Optimize Your Supply Chain with WIN SOURCE Solutions

-  Global Sourcing Solution
-  Obsolete Management
-  Cost Control Management
-  Shortage Management
-  Alternative Solution
-  Excess Inventory Management