



**THE DATASHEET OF
SF2163E**



- SAW Filter for Digital Television
- Complies with Directive 2002/95/EC (RoHS)
- Moisture Sensitivity Level: 1

Characteristics :

Balance-to-Balanced Operation

Terminating Source/Load Impedance : $Z_S = 150 \Omega$

Maximum Rating

Rating	Value	Units
Input Power Level	0	dBm
DC Voltage on any Non-ground Terminal	3	V
Operable Temperature Range	-45 to +125	°C
Specification Temperature Range	-40 to +85	°C
Storage Temperature Range in Tape and Reel	-40 to +85	°C
Maximum Soldering Profile, 5 cycles/ 10 seconds maximum	265	°C

SF2163E

**1076.06 MHz
SAW Filter**

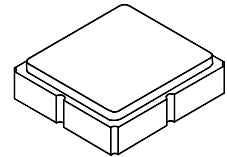

SM3030-8

Electrical Characteristics

Characteristic	Sym	Notes	Min	Typ	Max	Units
Center Frequency	f_C			1076.06		MHz
Maximum Insertion Loss, 1056.06 to 1096.06 MHz	IL_{MAX}			3.5	5.5	dB
1.5 dB Bandwidth				52		MHz
Amplitude Ripple, 1056.06 to 1096.06 MHz				1.0	2.2	dB
Attenuation, Referenced to IL_{MAX}						
50 to 994.04 MHz			45	53		dB
1158.20 to 3150 MHz			40	50		
3150 to 6000 MHz			18	20		
Group Delay Ripple, 1056.06 to 1096.06 MHz				15	40	nSp-p

Case Style	SM3030-8 3.0 x 3.0 mm Nominal Footprint
Lid Symbolization (Y=year, WW=week, S=shift) dot=pin 1 indicator	859, YWWS

Electrical Connection

	Connection	Terminals
Port 1	Balanced Input	1,2
Port 2	Balanced Output	5,6
	Ground	All Others

Dot Indicates Pin 1

 **CAUTION: Electrostatic Sensitive Device. Observe precautions for handling.**

NOTES:

1. The design, manufacturing process, and specifications of this device are subject to change.
2. US or International patents may apply.
3. RoHS compliant from the first date of manufacture.

Filter S_{11} , S_{22} and S_{21} Plots

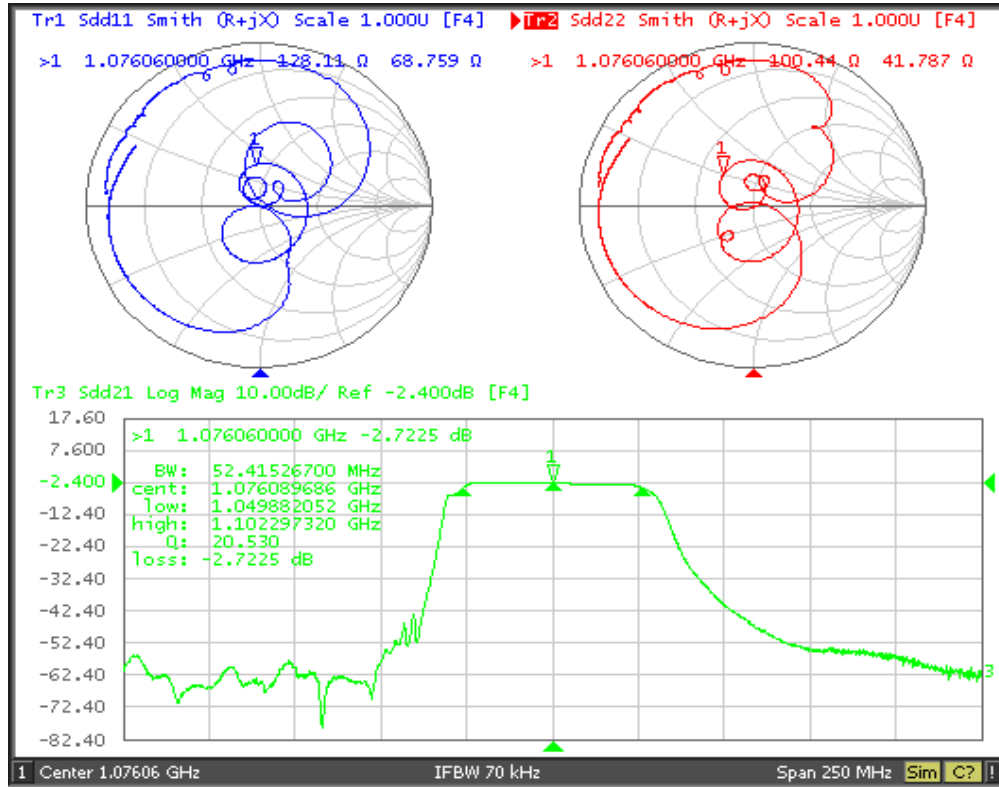

Filter Near-in Rejection

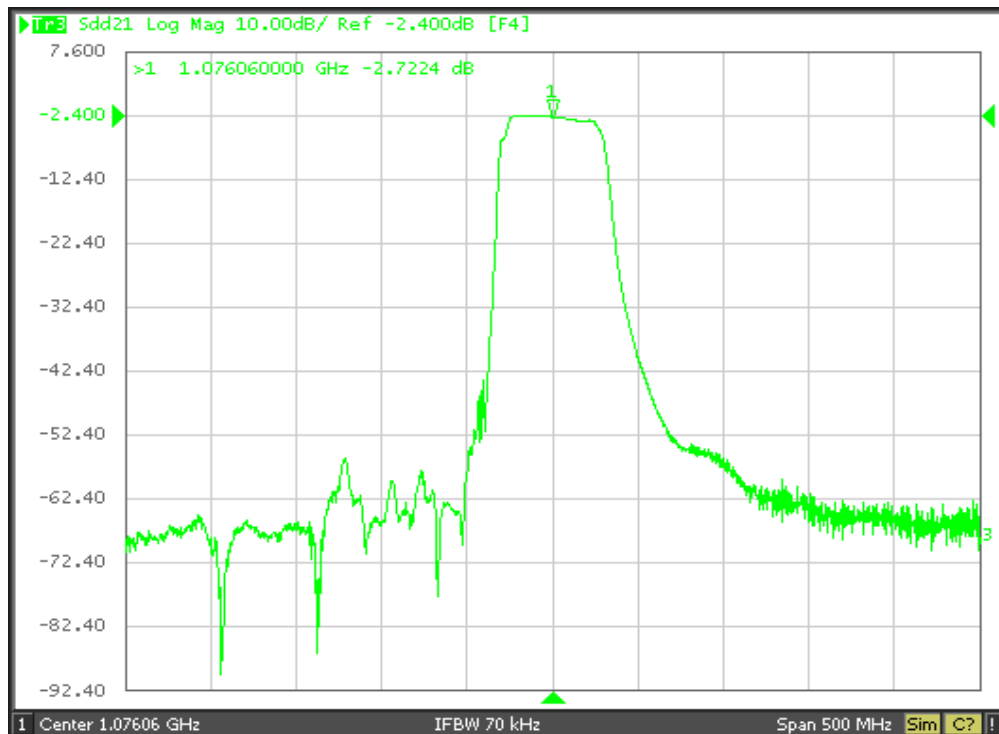

Filter Broadband Rejection

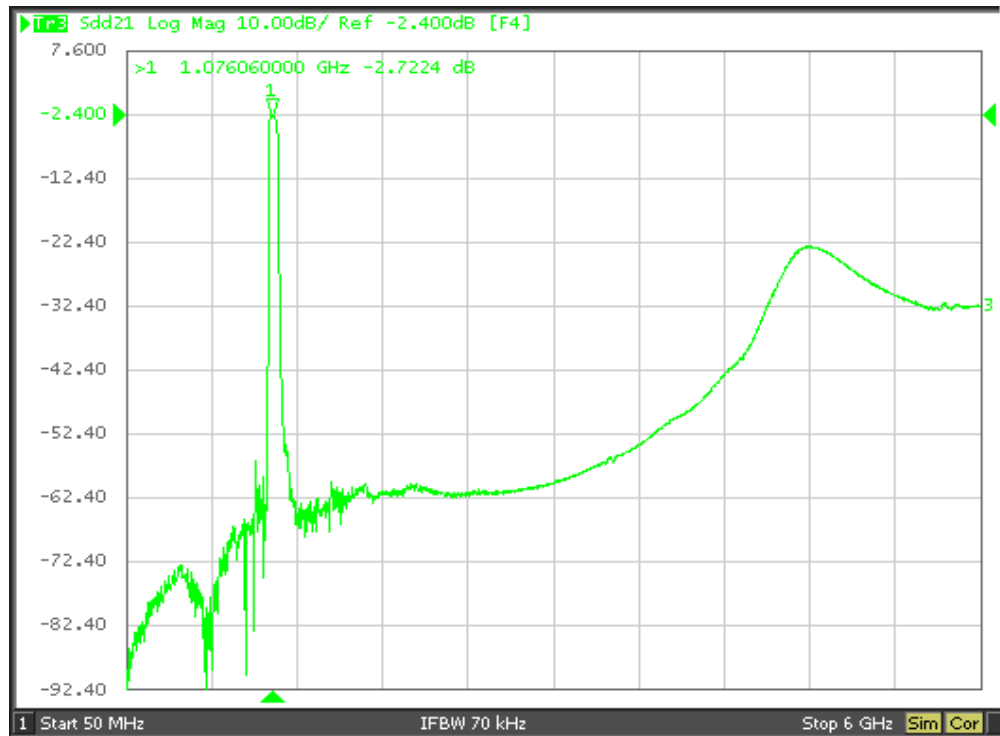

Filter Passband Amplitude and Group Delay Detail

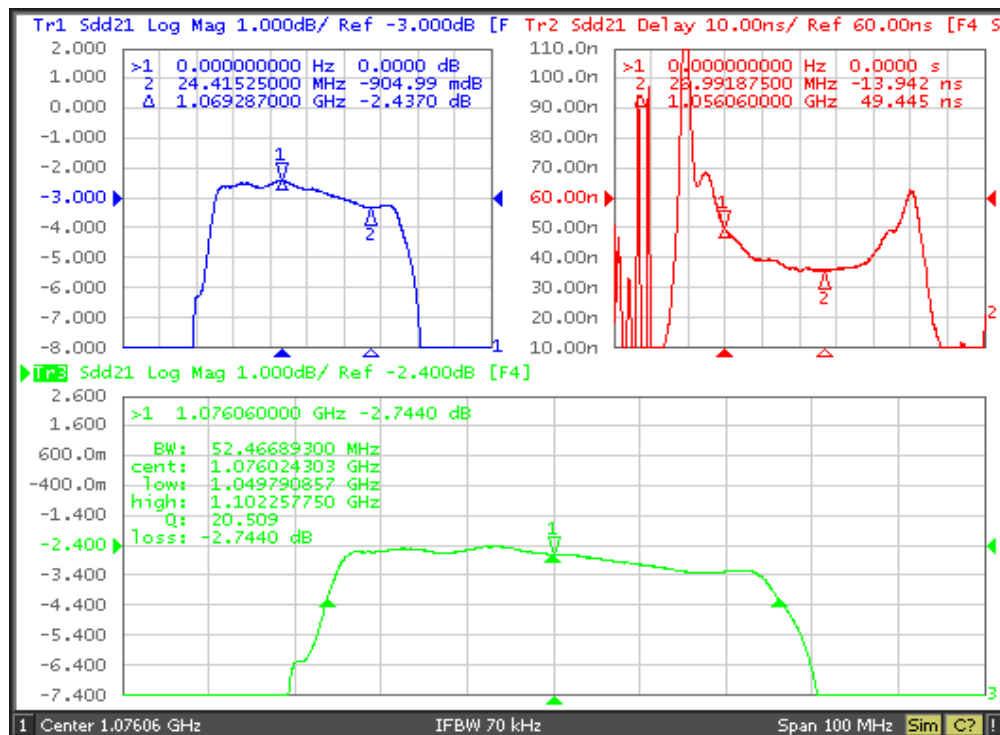

Tuning Network, 150 ohm Balanced Source/Load

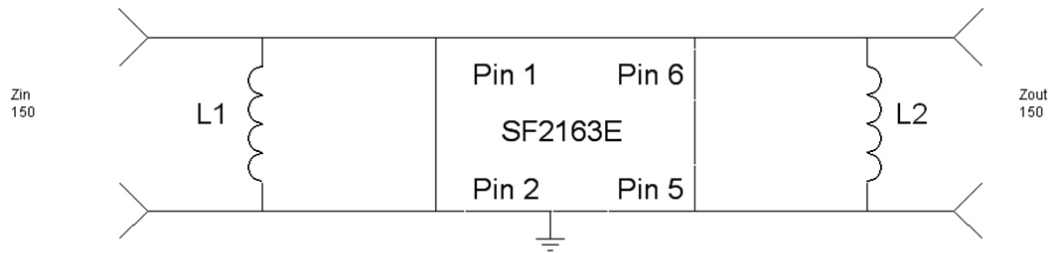

All other pins grounded

L1 **22 nH**
L2 **24 nH**

8-Terminal Ceramic Surface-Mount Case 3.0 X 3.0 mm Nominal Footprint

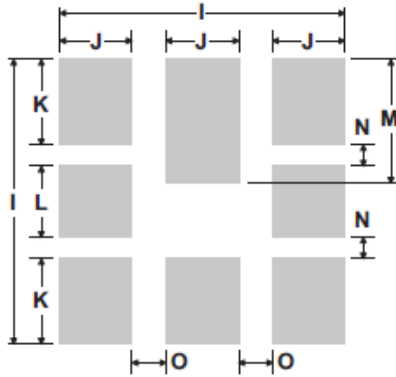
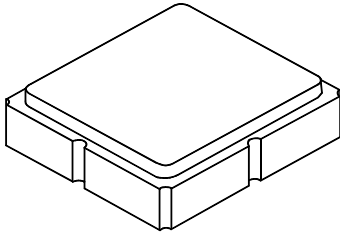

PCB Footprint Top View

Case and PCB Footprint Dimensions

Dimension	mm			Inches		
	Min	Nom	Max	Min	Nom	Max
A	2.87	3.0	3.13	0.113	0.118	0.123
B	2.87	3.0	3.13	0.113	0.118	0.123
C	1.14	1.27	1.40	0.045	0.050	0.055
D	0.79	0.92	1.05	0.031	0.036	0.041
E	0.62	0.75	0.88	0.024	0.029	0.034
F	0.47	0.60	0.73	0.018	0.024	0.029
G	0.47	0.60	0.73	0.018	0.024	0.029
H	1.07	1.20	1.33	0.042	0.047	0.052
I		3.19			0.126	
J		0.81			0.032	
K		0.96			0.038	
L		0.81			0.032	
M		1.39			0.055	
N		0.23			0.009	
O		0.38			0.015	

Case Materials

Materials	
Solder Pad Plating	0.3 to 1.0 μm Gold over 1.27 to 8.89 μm Nickel
Lid Plating	2.0 to 3.0 μm Nickel
Body	Al_2O_3 Ceramic

TOP VIEW

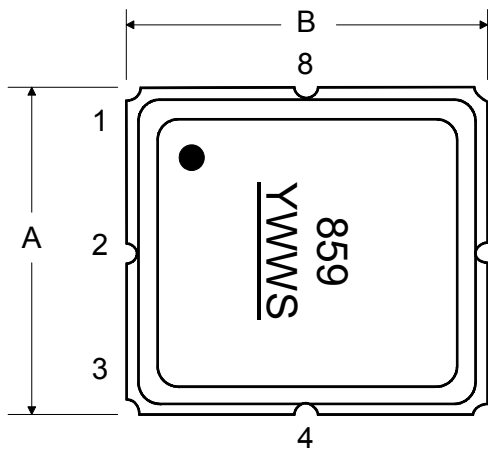

BOTTOM VIEW

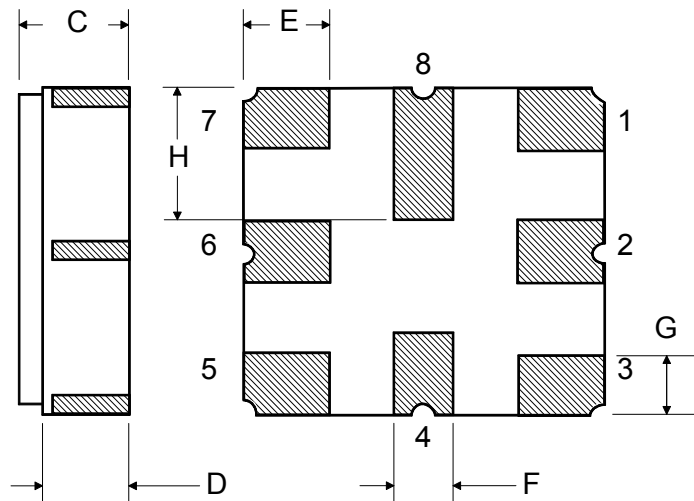

Tape and Reel Specifications

Tape and Reel Standard per ANSI/EIA481

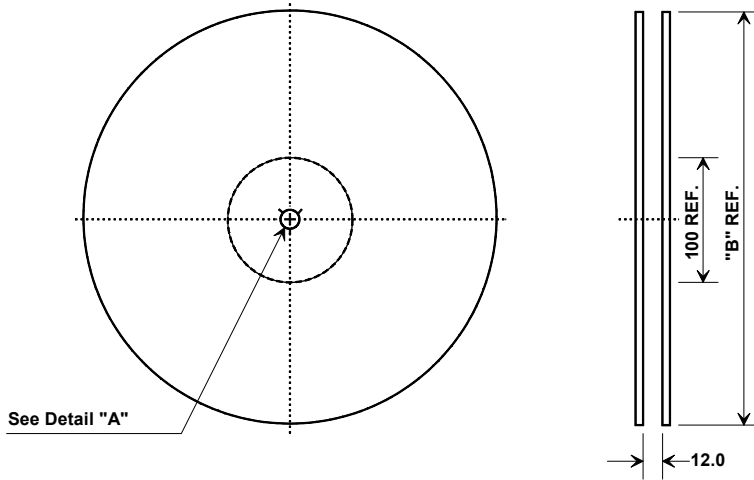

"B"		Quantity Per Reel
Inches	millimeters	
7	178	500
13	330	3000

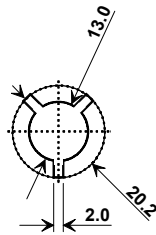

COMPONENT ORIENTATION and DIMENSIONS

Carrier Tape Dimensions	
Ao	3.35 mm
Bo	3.35 mm
Ko	1.40 mm
Pitch	8.0 mm
W	12.0 mm

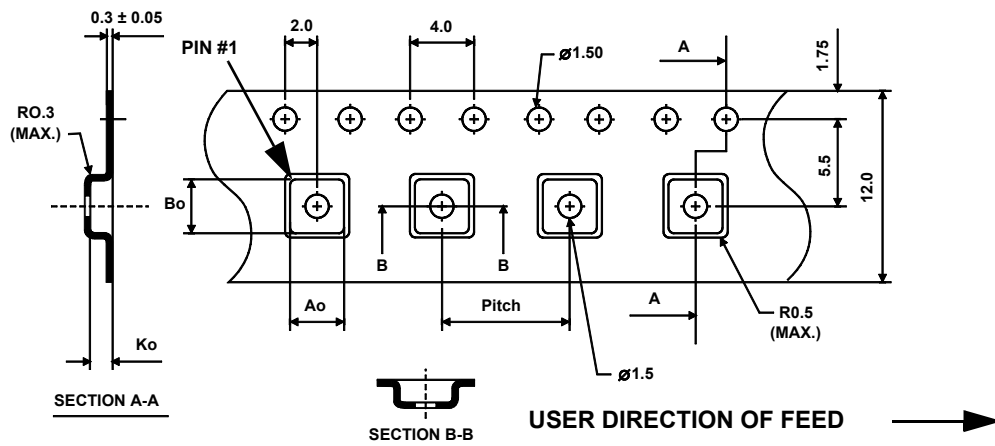

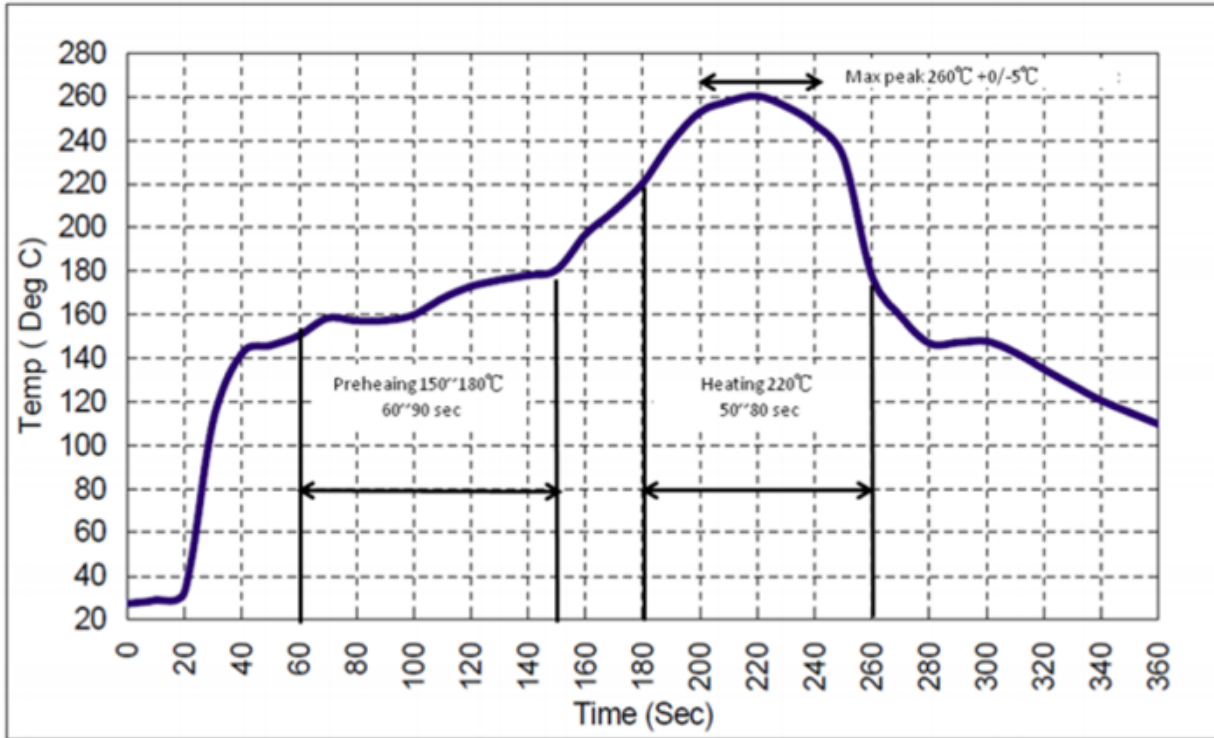

Recommended Reflow Profile

1. Preheating shall be fixed at 150~180° for 60~90 seconds.
2. Ascending time to preheating temperature 150° shall be 30 seconds min.
3. Heating shall be fixed at 220°C for 50~80 seconds and at 260°C peak (10 seconds.)
4. Time: 5 times maximum



Looking for pricing, stock, or lifecycle information?

Click below to explore more details on WIN SOURCE:

-  [View SF2163E on WIN SOURCE](#)
-  [RF Monolithics, Inc Information](#)

Optimize Your Supply Chain with WIN SOURCE Solutions

-  Global Sourcing Solution
-  Obsolete Management
-  Cost Control Management
-  Shortage Management
-  Alternative Solution
-  Excess Inventory Management