



**THE DATASHEET OF
SF1186E-2**



- **Designed for Front-end GPS Applications**
- **Low Insertion Loss**
- **3.0 x 3.0 x 1.3 mm Surface-mount Case**
- **No Matching Circuit Required**
- **Complies with Directive 2002/95/EC (RoHS)**
- **Moisture Sensitivity Level: 1**

Maximum Ratings at +25 °C Unless Stated Otherwise

Rating	Symbol	Value	Units
Maximum Input Signal Level		+10	dBm
DC Voltage on any Non-ground Terminal	WVdc	4	Volts
Operating Temperature Range	T _A	-40 to +95	°C
Storage Temperature Range on Tape and Reel	T _{STG}	-40 to +85	°C
Lead Soldering Temperature for 10 Seconds	T _{WAVE}	260	°C
Peak Reflow Solder Temp for 40 Seconds	T _{Reflow}	235	°C
Suitable for lead-free soldering - Max Soldering Temperature		260°C for 30 s	

SF1186E-2

**1575.42 MHz
SAW Filter**

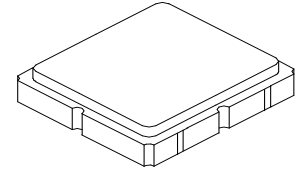

SM3030-6

Electrical Characteristics

Characteristic	Sym	Notes	Min	Typ	Max	Units
Center Frequency	f _O		1575.42			MHz
1 dB Bandwidth			2.046	15.3		MHz
Passband Amplitude Ripple, f _O ±2.0 MHz				0.1	2.0	dB _{P-P}
Passband VSWR				1.4	2.0	
Insertion Loss				2.68	3.5	dB
Attenuation Referenced to 0 dB:						
850 MHz			45	51.2		dB
1500 MHz			40	52.7		
1535.42 MHz			20	38.9		
1615.42 MHz			20	58.8		
1640 MHz			45	59.1		
1700 MHz			50	56.7		
Temperature Coefficient			-30			ppm/°C
Operating Temperature	T _A		-40		+95	°C
Single-ended Input /Output Impedance Match	No matching network required for operation at 50 ohms					
Case Style	SM3030-6 3 x 3 mm Nominal Footprint					
Lid Symbolization	Y=year, WW=week, S=shift		979 YWWS			

Electrical Connections

Pin #	Description	Pin #	Description
1	Ground	4	Ground
2	Input	5	Output
3	Ground	6	Ground

 **CAUTION: Electrostatic Sensitive Device. Observe precautions for handling.**

NOTES:

1. The design, manufacturing process, and specifications of this device are subject to change.
2. US or International patents may apply.
3. RoHS compliant from the first date of manufacture.

Transfer function :

(1) S21 response (span : 300 MHz)

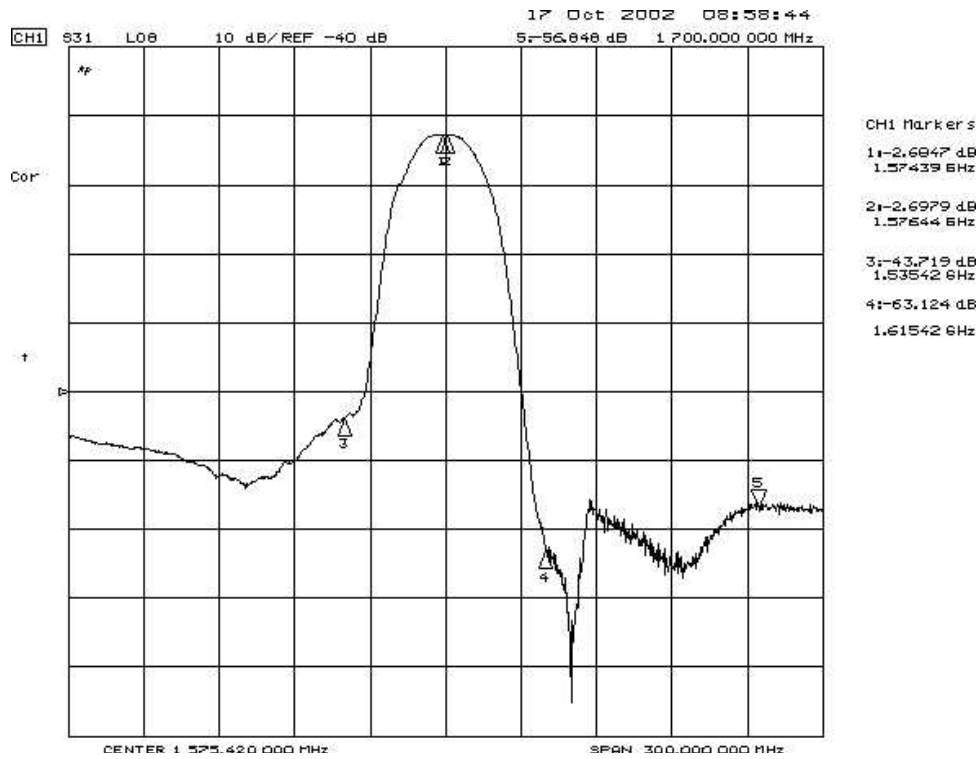

(2) S21 response (span : 3 GHz)

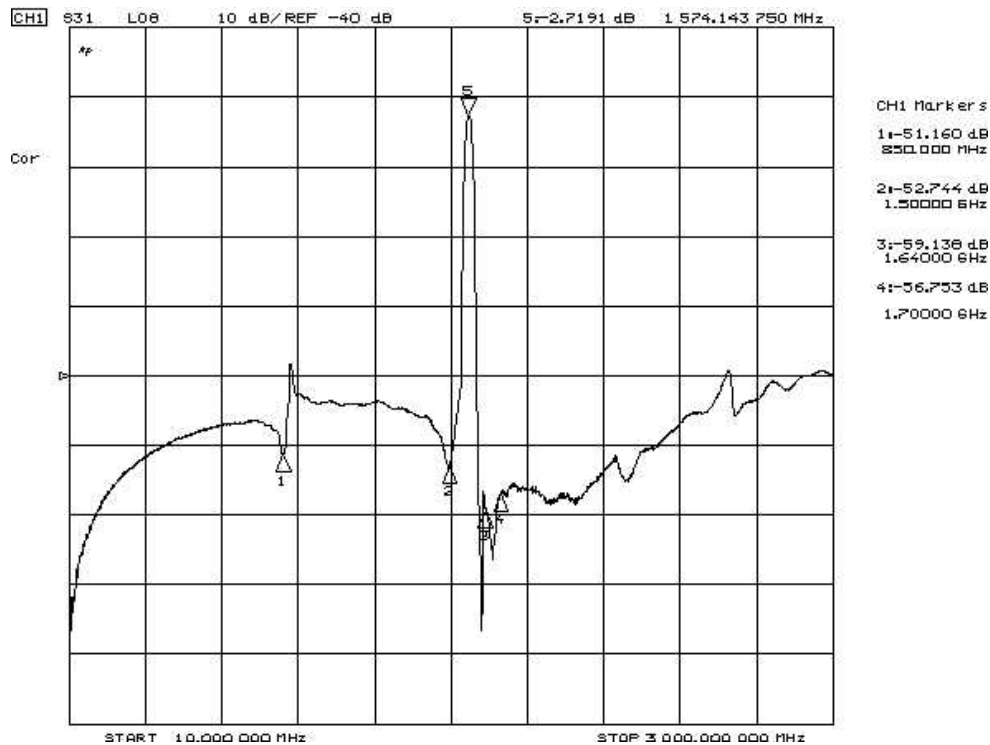

Reflection Functions:

S11

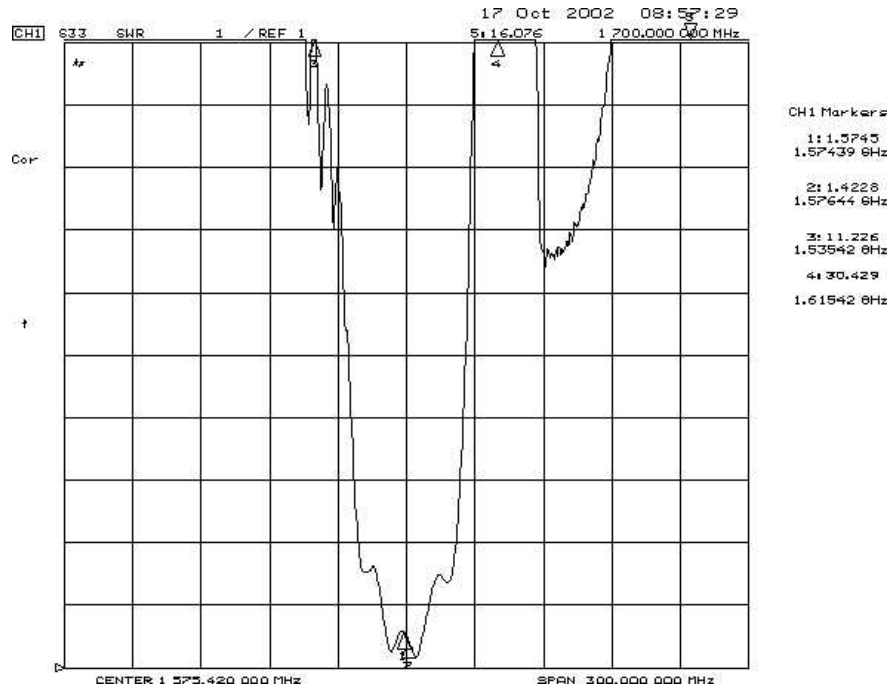

S22

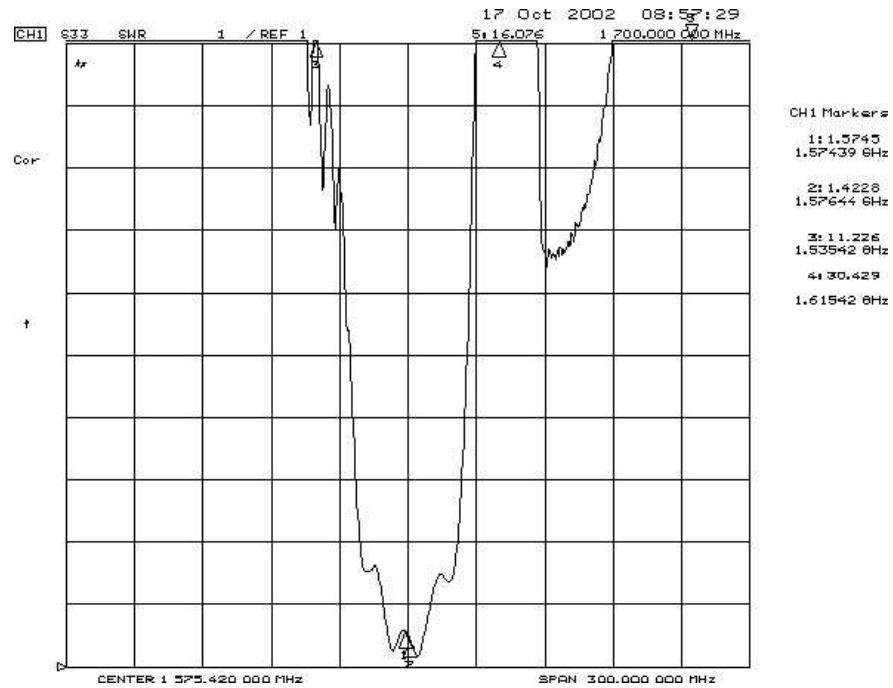

Reflection Functions:

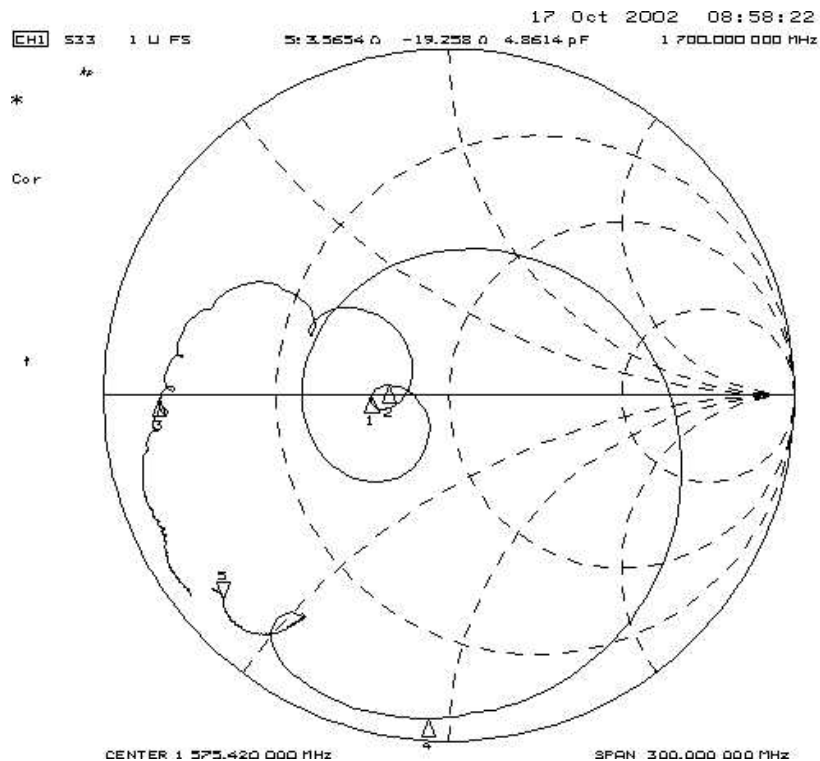
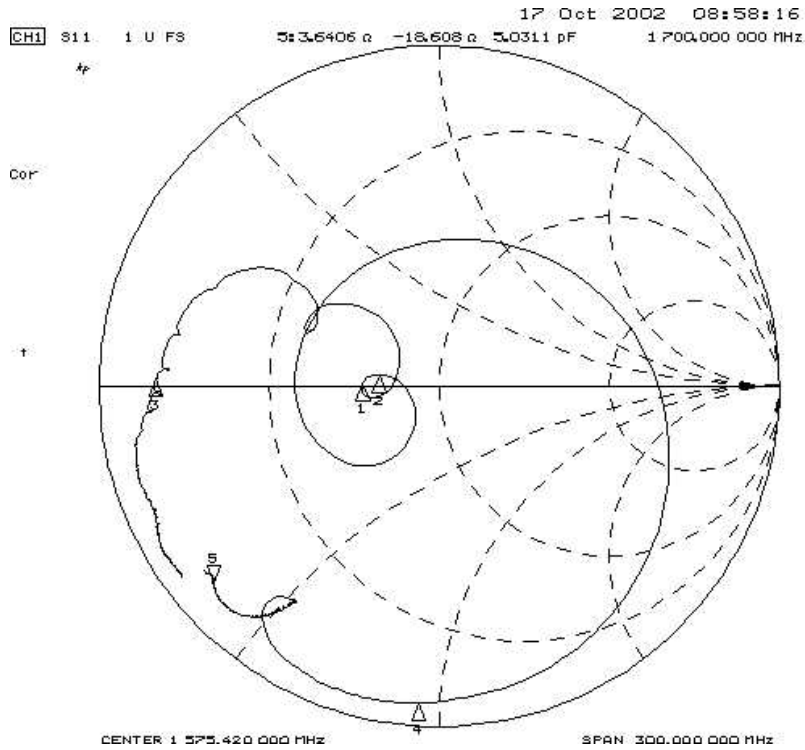

SM3030-6 Case

6-Terminal Ceramic Surface-Mount Case

3.0 X 3.0 mm Nominal Footprint

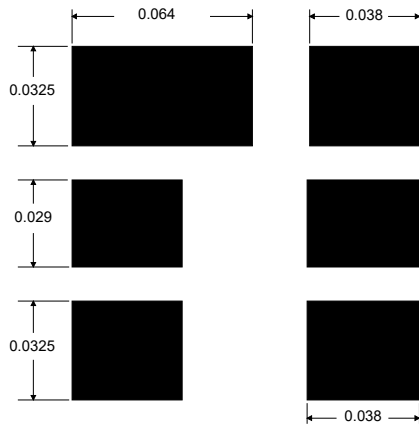
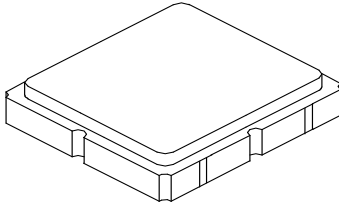

Foot Print Dimensions in Nominal Inches

Case Dimensions						
Dimension	mm			Inches		
	Min	Nom	Max	Min	Nom	Max
A	2.87	3.0	3.13	0.113	0.118	0.123
B	2.87	3.0	3.13	0.113	0.118	0.123
C	1.12	1.25	1.38	0.044	0.049	0.054
D	0.77	0.9	1.03	0.030	0.035	0.040
E	2.67	2.80	2.93	0.105	0.110	0.115
F	1.47	1.6	1.73	0.058	0.063	0.068
G	0.72	0.85	0.98	0.028	0.033	0.038
H	1.37	1.5	1.63	0.054	0.059	0.064
I	0.47	0.6	0.73	0.019	0.024	0.029
J	1.17	1.3	1.43	0.046	0.051	0.056

Electrical Connections		
Connection		Terminals
Port 1	Single-ended Input	2
Port 2	Single-ended Output	5
	Ground	All others
Single-ended Operation Only		
Dot indicates Pin 1		

Case Materials	
Solder Pad Plating	0.3 to 1.0 μm Gold over 1.27 to 8.89 μm Nickel
Lid Plating	2.0 to 3.0 μm Nickel
Body	Al_2O_3 Ceramic

TOP VIEW

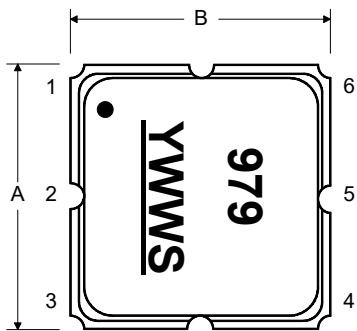

BOTTOM VIEW

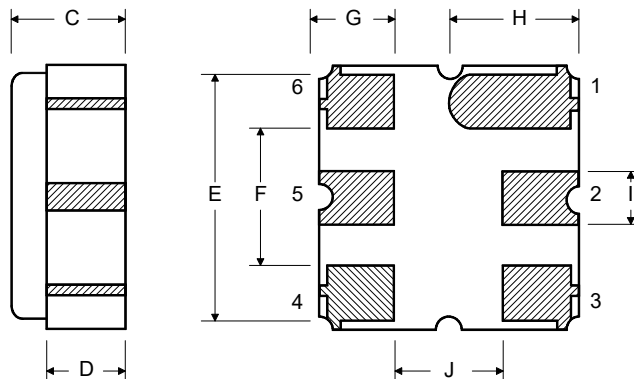

Tape and Reel Specifications

Tape and Reel Standard per ANSI/EIA-481

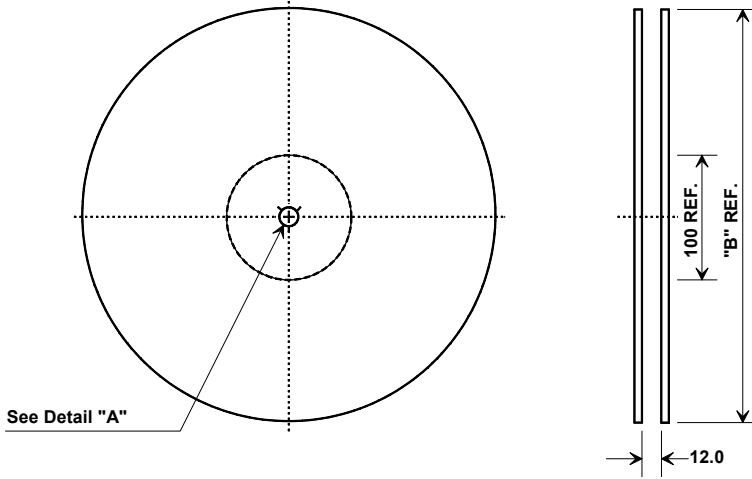

"B"		Quantity Per Reel
Inches	millimeters	
7	178	500
13	330	3000

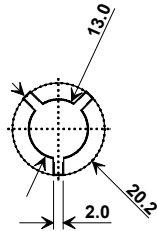

COMPONENT ORIENTATION

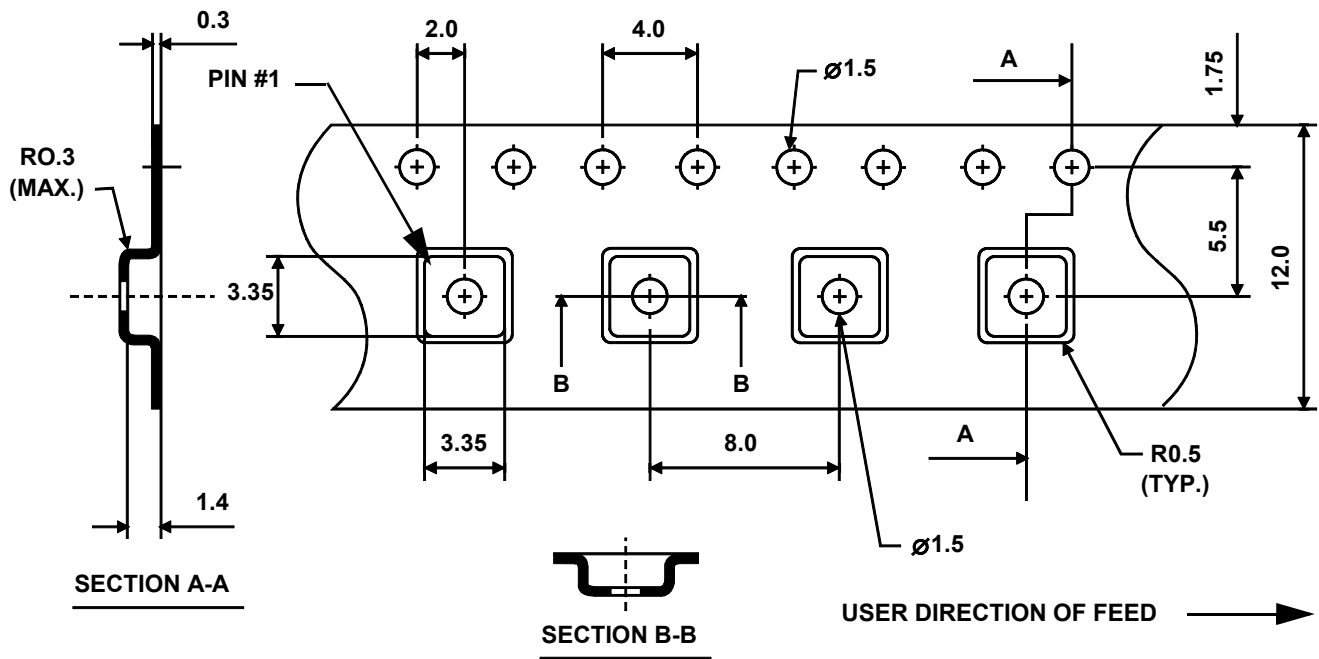

Recommended Reflow Profile

1. Preheating shall be fixed at 150~180°C for 60~90 seconds.
2. Ascending time to preheating temperature 150°C shall be 30 seconds min.
3. Heating shall be fixed at 220°C for 50~80 seconds and at 260°C+0/-5°C peak (10 seconds).
4. Time: 5 times maximum.

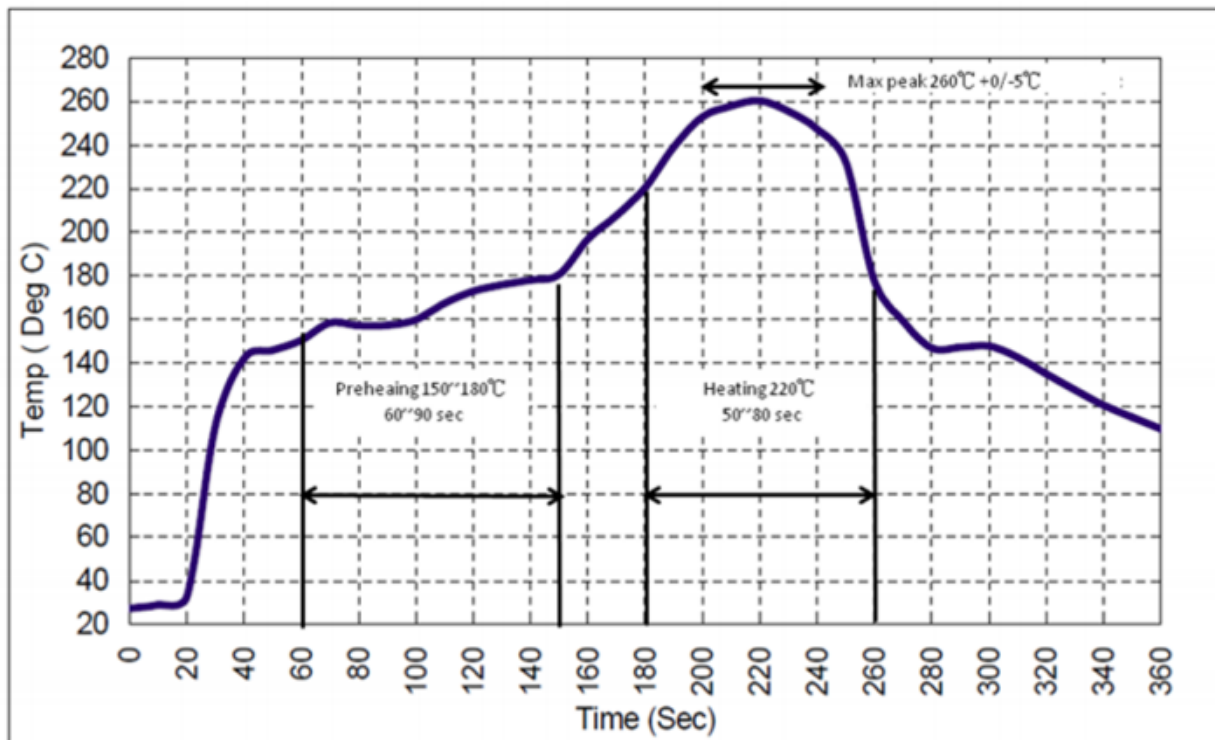

Looking for pricing, stock, or lifecycle information?

Click below to explore more details on WIN SOURCE:

 [View SF1186E-2 on WIN SOURCE](#)

 [RF Monolithics, Inc Information](#)

Optimize Your Supply Chain with WIN SOURCE Solutions

-  Global Sourcing Solution
-  Obsolete Management
-  Cost Control Management
-  Shortage Management
-  Alternative Solution
-  Excess Inventory Management