



**THE DATASHEET OF**  
**SF2316E-1**



# SF2316E-1

## 1582 MHz SAW Filter

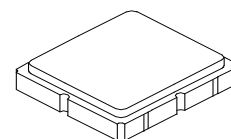

SM3030-6

- Low-loss 1582 MHz SAW Filter
- Designed for 50 ohm Source/Load
- Operable Temperature Range -45°/125°C
- Complies with Directive 2002/95/EC (RoHS)
- Moisture Sensitivity Level: 1
- AEC-Q200 Qualified

Absolute Maximum Ratings	Value	Units
Input Power Level	+10	dBm
DC Voltage on any Non-ground Terminal	3	V
Operable Temperature Range	-45 to +125	°C
Operating Temperature Range	-40 to +105	°C
Storage Temperature Range in Tape and Reel	-40 to +85	°C

### Electrical Characteristics

Characteristic	Sym	Notes	Min	Typ	Max	Units
Center Frequency	$f_c$			1582		MHz
Insertion Loss, 1565.42 to 1585.42MHz	IL			1.8	2.4	dB
Insertion Loss, 1574.42 to 1576.42MHz				1.6	2.2	
Insertion Loss, 1576.42 to 1597.42MHz				1.6	2.2	
Insertion Loss, 1597.55 to 1605.89MHz (-40 to +85°) (-40 to +105°C)				2.0 2.0	2.6 2.8	
GD Ripple, 1597.55 to 1605.89 MHz				8.5	20	ns
Amplitude Ripple, 1559 to 1606 MHz (-40 to +85°C) (-40 to +105°C)				0.9 0.9	2.0 2.5	dB
VSWR, 1565.42 to 1585.42 MHz				2.0	2.2	
VSWR, 1597.55 to 1605.89 MHz				1.4	2.0	dB
Attenuation,						
1 to 925 MHz			32	37		
925 to 960 MHz			32	37		
1427 to 1453 MHz			35	45		
1453 to 1501 MHz			35	46		
1501 to 1525 MHz			30	37		
1626 to 1660 MHz			30	43		
1710 to 1785 MHz			35	40		
1850 to 1910 MHz			35	41		
1920 to 1980 MHz			35	42		
2110 to 2170 MHz			35	44		
2400 to 2500 MHz			40	46		
2500 to 2570 MHz			40	44		
Case Style	SMD 3.0 x 3.0 mm Nominal Footprint					
Lid Symbolization (Y=year, WW=week, S=shift) dot=pin 1 indicator	A80, YWWS					

 **CAUTION: Electrostatic Sensitive Device. Observe precautions for handling.**

**NOTES:**

1. The design, manufacturing process, and specifications of this device are subject to change.
2. US or International patents may apply.
3. RoHS compliant from the first date of manufacture.

**Measurement Circuit:**

HP Network analyzer

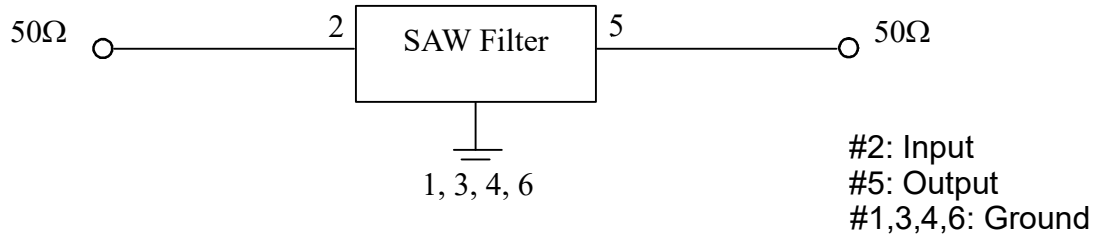

**Frequency Characteristics:  
S21 response: (span 2.6 GHz)**

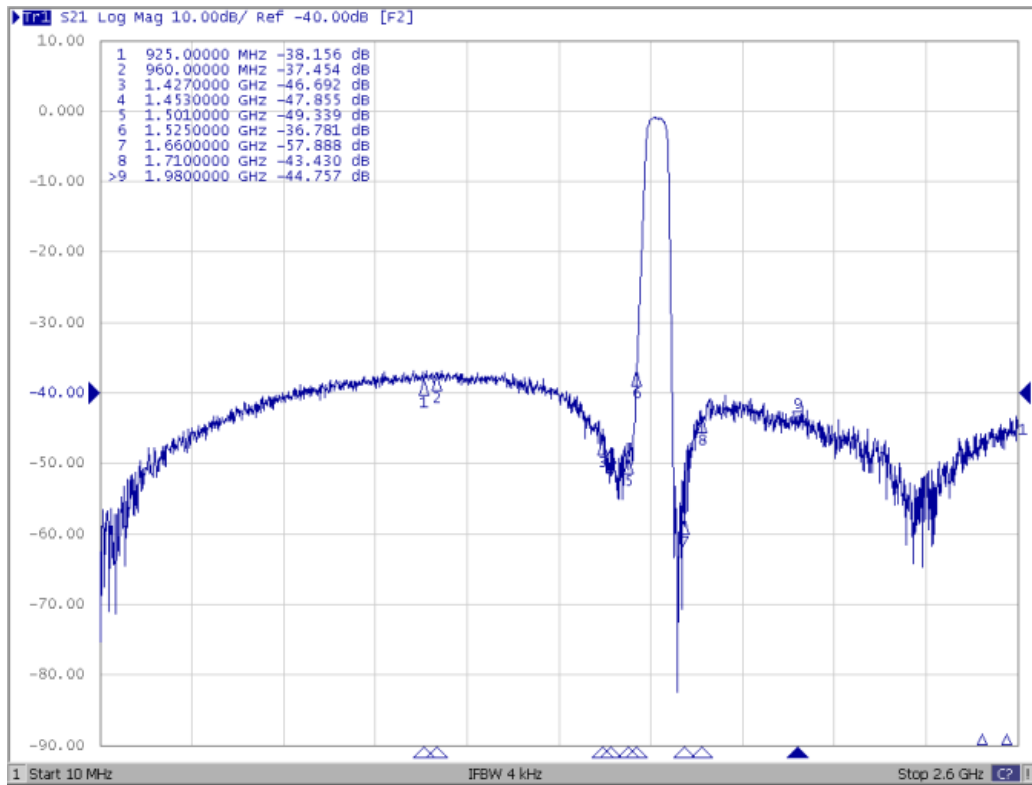

## S21 response: (span 500 MHz)

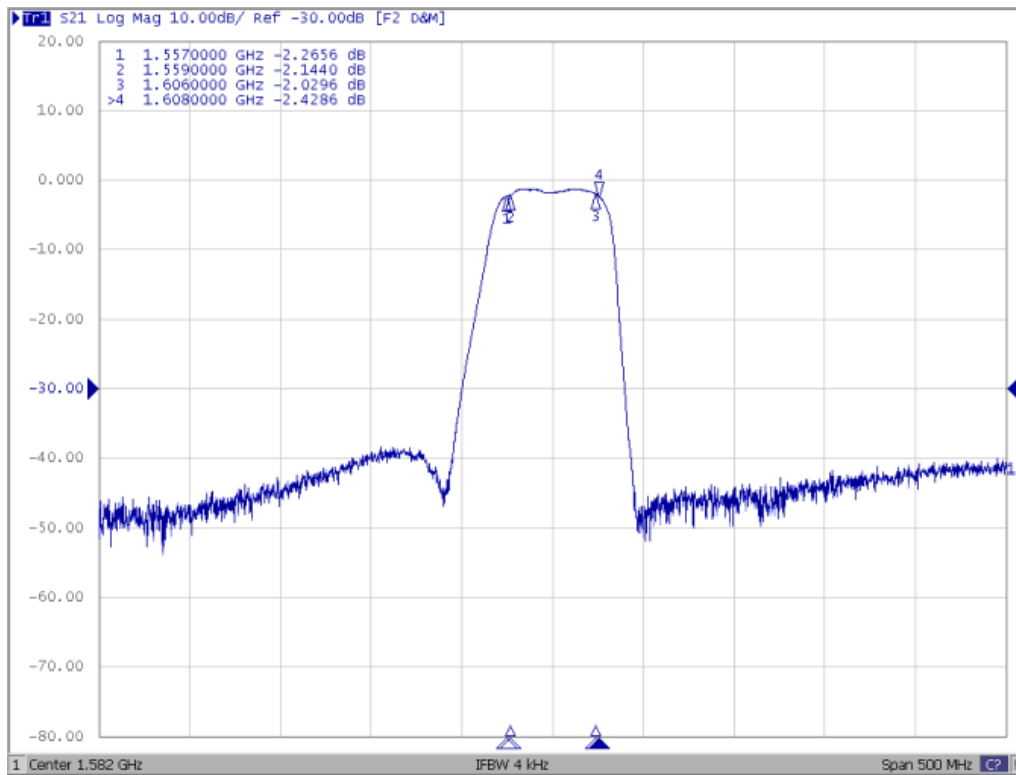

## S21 response: (span 100 MHz)

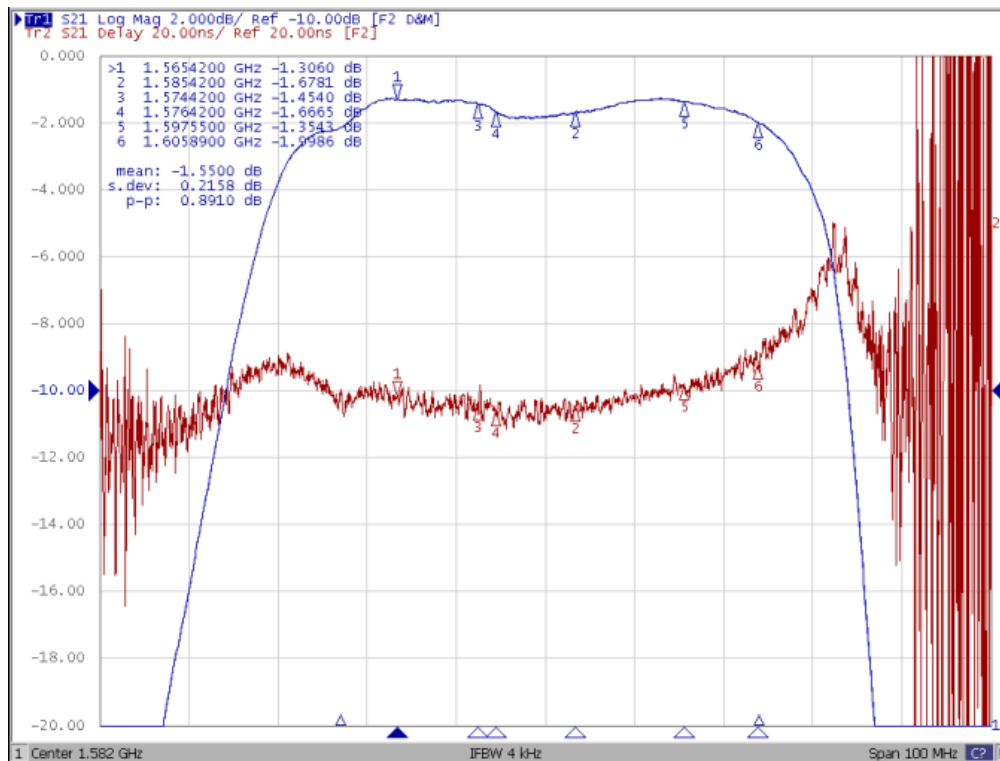

# S11 and S22VSWR: (span 100 MHz)

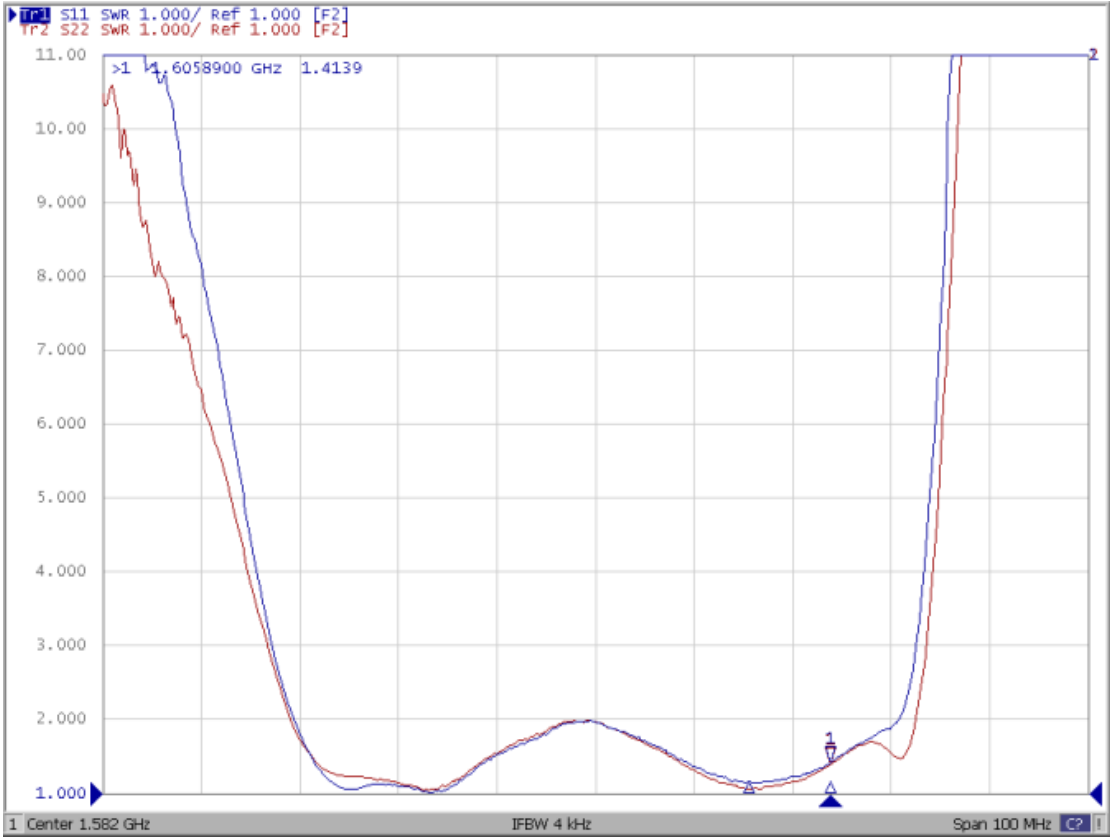

# SM3030-6 Ceramic 6-Terminal Surface-Mount Case 3.0 X 3.0 mm Nominal Footprint

## Case and PCB Footprint Dimensions

Dimension	mm			Inches		
	Min	Nom	Max	Min	Nom	Max
A	2.87	3.00	3.13	0.113	0.118	0.123
B	2.87	3.00	3.13	0.113	0.118	0.123
C	1.12	1.25	1.38	0.044	0.049	0.054
D	0.77	0.90	1.03	0.030	0.035	0.040
E	2.67	2.80	2.93	0.105	0.110	0.115
F	1.47	1.60	1.73	0.058	0.063	0.068
G	0.72	0.85	0.98	0.028	0.033	0.038
H	1.37	1.50	1.63	0.054	0.059	0.064
I	0.47	0.60	0.73	0.019	0.024	0.029
J	1.17	1.30	1.43	0.046	0.051	0.056
K		3.20			0.126	
L		1.70			0.067	
M		1.05			0.041	
N		0.81			0.032	
O		0.38			0.015	

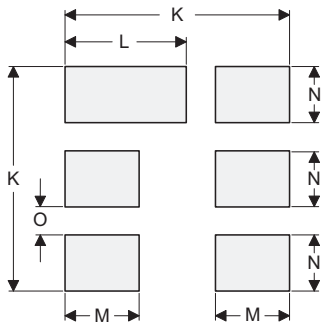
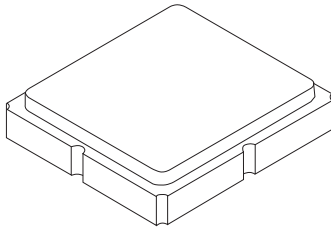

**PCB Footprint Top View**

## Case Materials

Materials	
Solder Pad Plating	0.3 to 1.0 $\mu$ m Gold over 1.27 to 8.89 $\mu$ m Nickel
Lid Plating	2.0 to 3.0 $\mu$ m Nickel
Body	Al <sub>2</sub> O <sub>3</sub> Ceramic

## Electrical Connections

Connection	Terminals
Input	2
Output	5
Case Ground	All others

## TOP VIEW

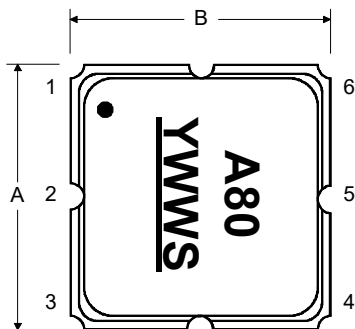

## BOTTOM VIEW

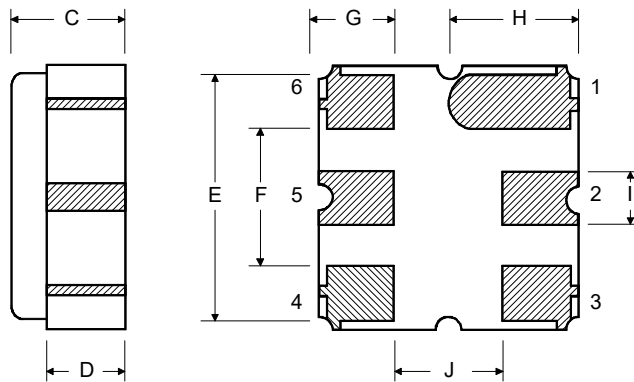

## Tape and Reel Specifications

Tape and Reel Standard per ANSI/EIA-481

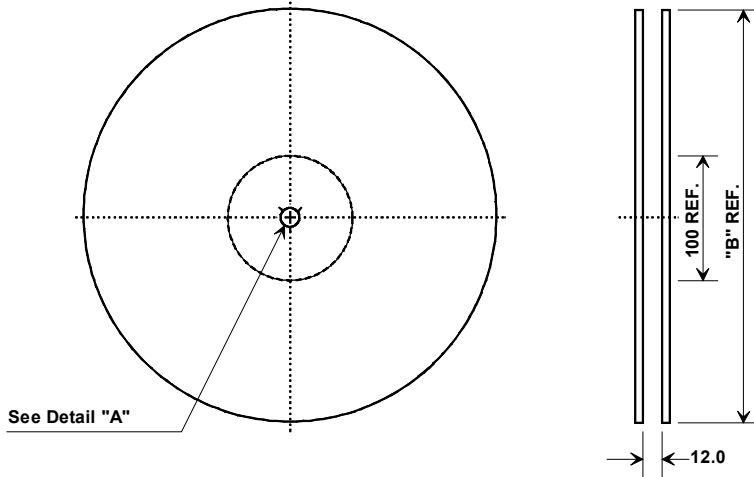

"B"		Quantity Per Reel
Inches	millimeters	
7	178	500
13	330	3000

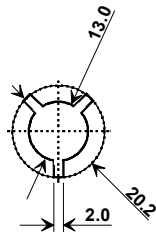

### COMPONENT ORIENTATION and DIMENSIONS

Carrier Tape Dimensions	
Ao	3.35 mm
Bo	3.35 mm
Ko	1.40 mm
Pitch	8.0 mm
W	12.0 mm

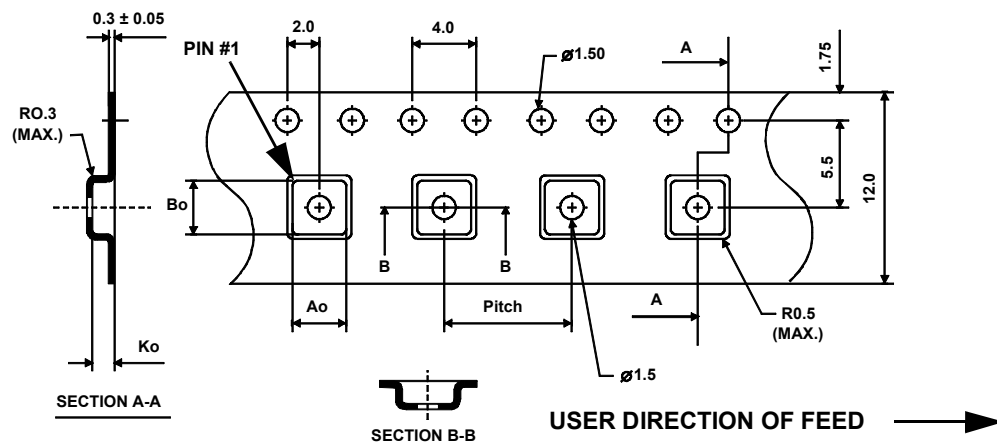

## Recommended Reflow Profile

1. Preheating shall be fixed at 150~180°C for 60~90 seconds.
2. Ascending time to preheating temperature 150°C shall be 30 seconds min.
3. Heating shall be fixed at 220°C for 50~80 seconds and at 260°C +0/-5°C peak (10 seconds).
4. Time: 5 times maximum.

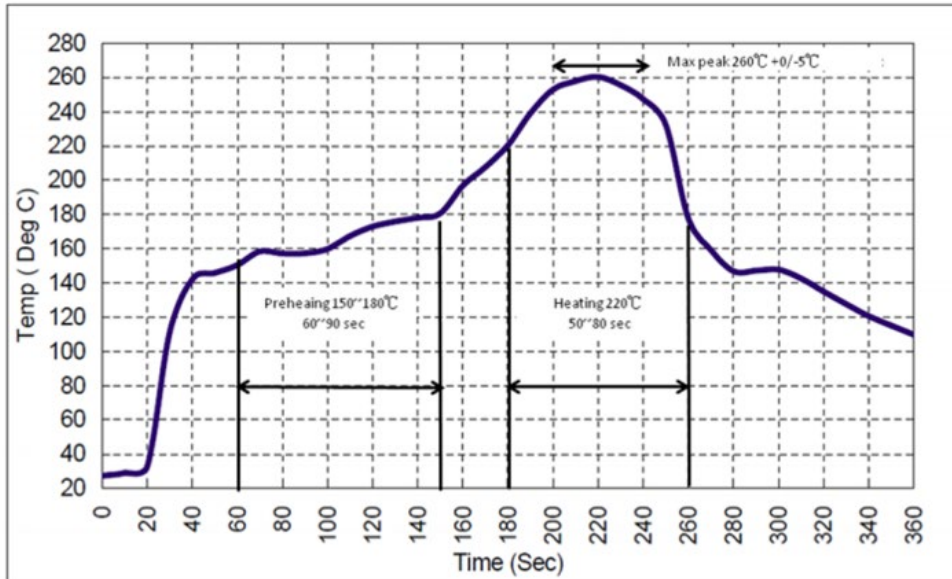

## Looking for pricing, stock, or lifecycle information?

Click below to explore more details on WIN SOURCE:

- ⊖ [View SF2316E-1 on WIN SOURCE](#)
- ⊖ [RF Monolithics, Inc Information](#)

## Optimize Your Supply Chain with WIN SOURCE Solutions

- ✓ Global Sourcing Solution
- ✓ Obsolete Management
- ✓ Cost Control Management
- ✓ Shortage Management
- ✓ Alternative Solution
- ✓ Excess Inventory Management