



**THE DATASHEET OF  
SF2191E**



- **Low Loss L-Band SAW Filter**
- **No External Components Required for 50 ohm Match**
- **Surface Mount 3.0 x 3.0 mm Package**
- **Complies with Directive 2002/95/EC (RoHS)**
- **Moisture Sensitivity Level: 1**

**SF2191E**

**1620.75 MHz  
SAW Filter**

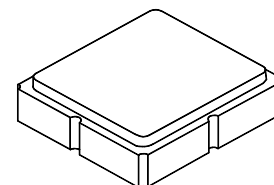

**SM3030-6**

**Absolute Maximum Ratings**

Rating	Value	Units
Input Power Level	5	dBm
DC Voltage	3	V
Operating Temperature Range	-20 to +75	°C
Storage Temperature Range in Tape and Reel	-40 to +85	°C
Maximum Soldering Profile, 5 cycles/10 seconds maximum	265	°C

**Electrical Characteristics**

Characteristic	Sym	Notes	Min	Typ	Max	Units
Center Frequency	$f_C$			1620.75		MHz
Insertion Loss, 1615 to 1626.5 MHz	IL			1.3	2.8	dB
Amplitude Ripple, 1615 to 1626.5 MHz				0.3	1.8	dB <sub>p-p</sub>
Rejection Referenced to 0 dB:						dB
1100 to 1400 MHz			30	35		
1400 to 1560 MHz			30	37		
1538 MHz			35	37		
1680 to 1825 MHz			30	40		
1691 MHz			35	40		
1825 to 1900 MHz			35	40		
Source Impedance	$Z_S$			50		$\Omega$
Load Impedance	$Z_L$			50		
Case Style	SM3030-8 3.0 x 3.0 mm Nominal Footprint					
Lid Symbolization (Y=year, WW=week, S=shift) dot=pin 1 indicator	896, <u>YWWS</u>					

**Electrical Connections**

Connection	Terminals
Input	2
Output	5
Case Ground	All others

 **CAUTION: Electrostatic Sensitive Device. Observe precautions for handling.**

**NOTES:**

1. The design, manufacturing process, and specifications of this device are subject to change.
2. US or International patents may apply.
3. RoHS compliant from the first date of manufacture.

## SF2191E Broadband Response, 1020.75 to 2220.75 MHz

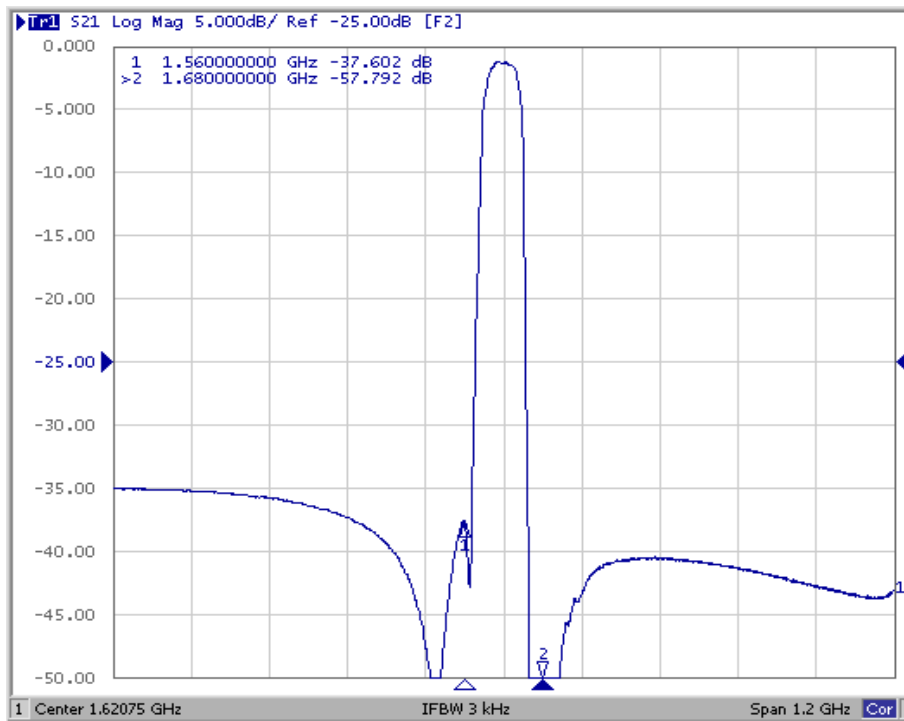

## SF2191E Passband Response

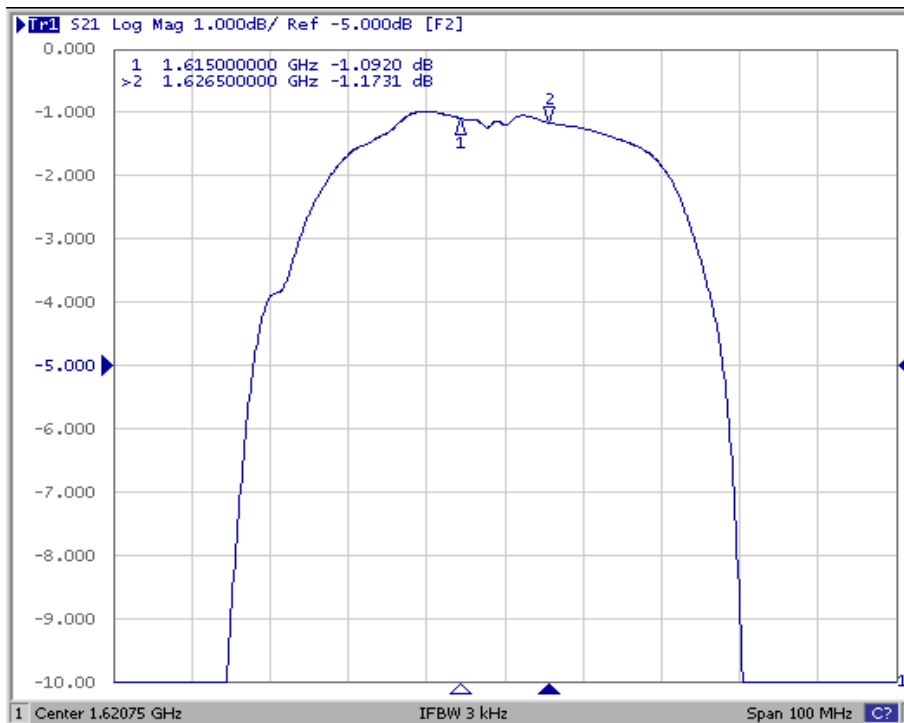

## SF2191E Input VSWR

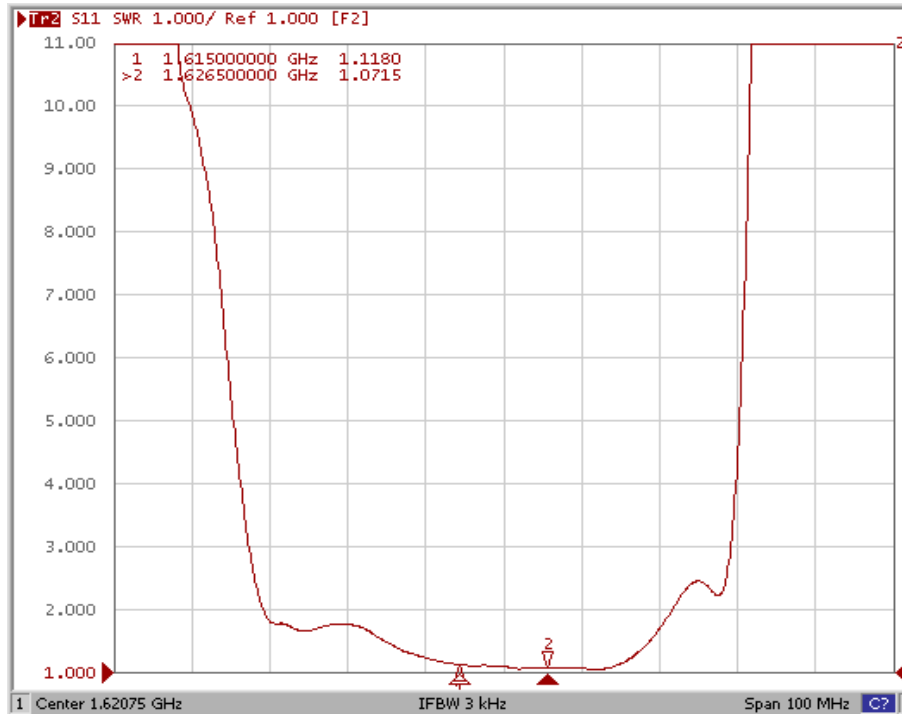

## SF2191E Output VSWR

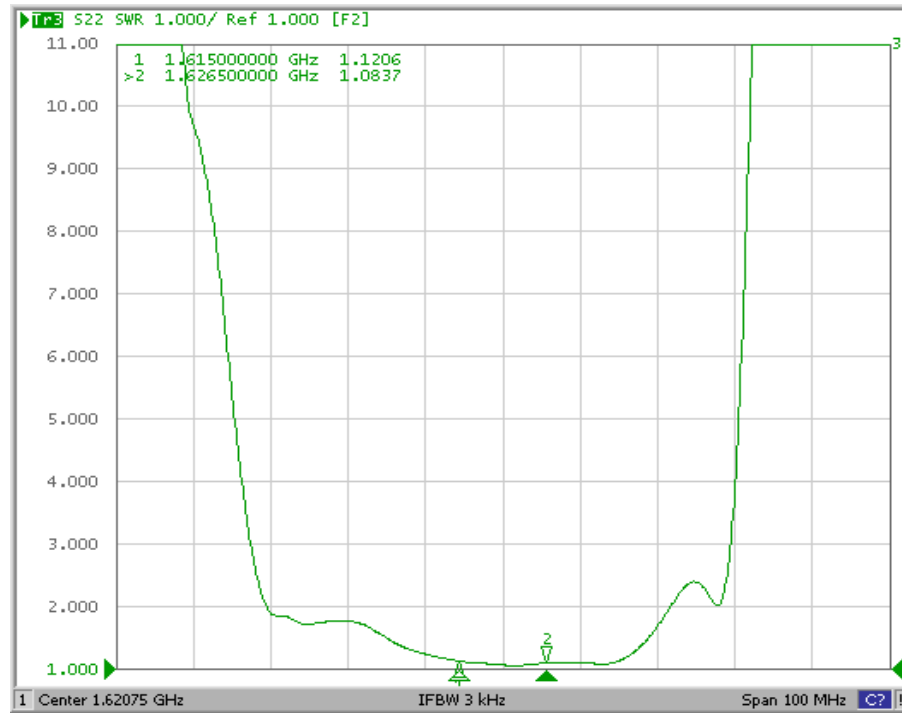

# SM3030-6 Case

## 6-Terminal Ceramic Surface-Mount Case

### 3.0 X 3.0 mm Nominal Footprint

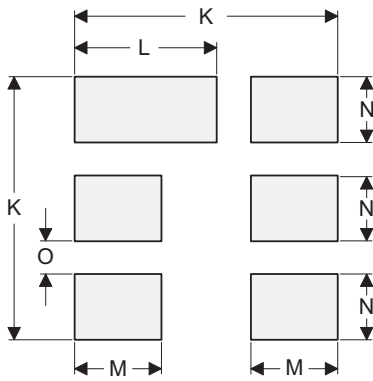
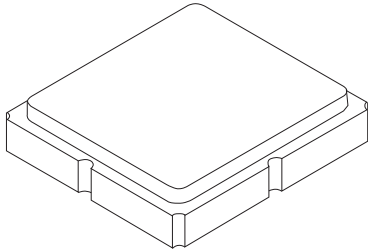

PCB Footprint Top View

#### Case and PCB Footprint Dimensions

Dimension	mm			Inches		
	Min	Nom	Max	Min	Nom	Max
A	2.87	3.00	3.13	0.113	0.118	0.123
B	2.87	3.00	3.13	0.113	0.118	0.123
C	1.12	1.25	1.38	0.044	0.049	0.054
D	0.77	0.90	1.03	0.030	0.035	0.040
E	2.67	2.80	2.93	0.105	0.110	0.115
F	1.47	1.60	1.73	0.058	0.063	0.068
G	0.72	0.85	0.98	0.028	0.033	0.038
H	1.37	1.50	1.63	0.054	0.059	0.064
I	0.47	0.60	0.73	0.019	0.024	0.029
J	1.17	1.30	1.43	0.046	0.051	0.056
K		3.20			0.126	
L		1.70			0.067	
M		1.05			0.041	
N		0.81			0.032	
O		0.38			0.015	

#### Case Materials

Materials	
Solder Pad Plating	0.3 to 1.0 $\mu$ m Gold over 1.27 to 8.89 $\mu$ m Nickel
Lid Plating	2.0 to 3.0 $\mu$ m Nickel
Body	Al <sub>2</sub> O <sub>3</sub> Ceramic

Top View

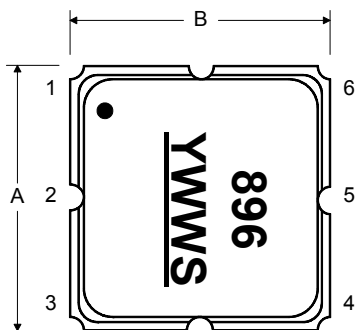

Bottom View

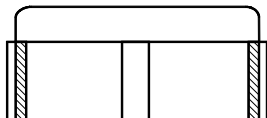
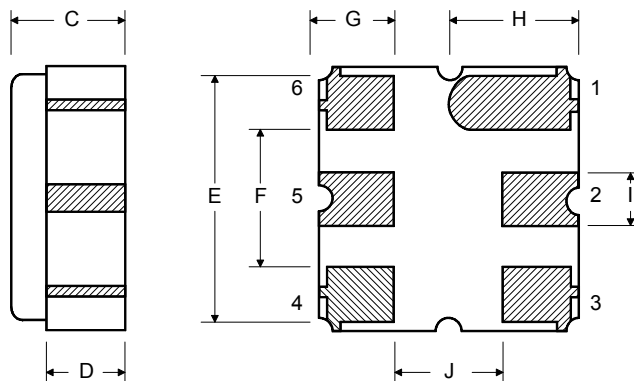



## Recommended Reflow Profile

1. Preheating shall be fixed at 150~180°C for 60~90 seconds.
2. Ascending time to preheating temperature 150°C shall be 30 seconds min.
3. Heating shall be fixed at 220°C for 50~80 seconds and at 260°C +0/-5°C peak (10 seconds).
4. Time: 5 times maximum.

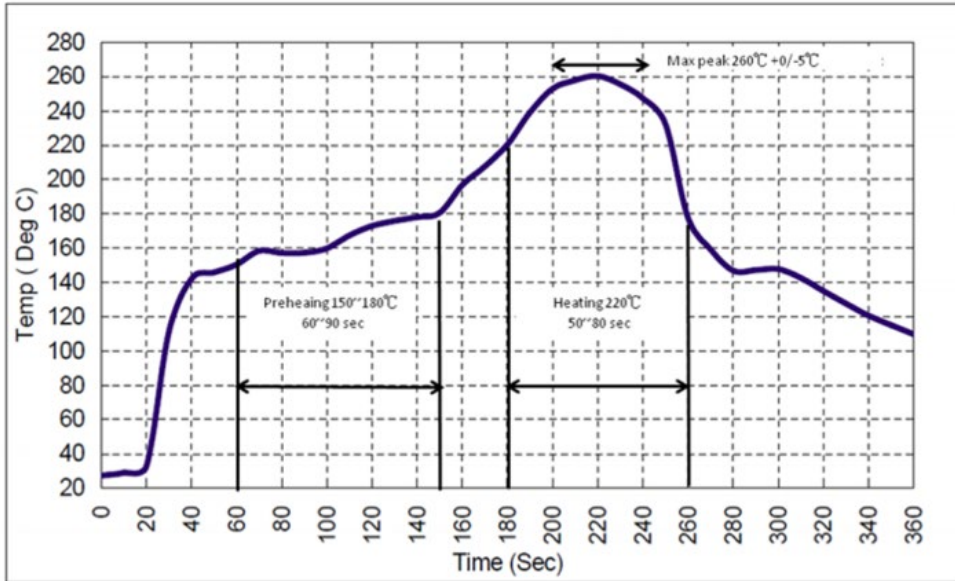

## Looking for pricing, stock, or lifecycle information?

Click below to explore more details on WIN SOURCE:

 [View SF2191E on WIN SOURCE](#)

 [RF Monolithics, Inc Information](#)

## Optimize Your Supply Chain with WIN SOURCE Solutions

-  Global Sourcing Solution
-  Obsolete Management
-  Cost Control Management
-  Shortage Management
-  Alternative Solution
-  Excess Inventory Management