

- *Small Size*
- *Hermetic 5 X 7 mm Surface-mount Case*
- *Differential Input/Output*
- *Complies with Directive 2002/95/EC (RoHS)*
- *Moisture Sensitivity Level: 1*
- *AEC-Q200 Qualified*

Absolute Maximum Ratings

Rating	Value	Units
Maximum Incident Power in Passband	+10	dBm
Maximum DC Voltage Between any Two Terminals	3	VDC
Operating Temperature Range	-40 to +85	°C
Storage Temperature Range in Tape and Reel	-40 to +85	°C
Maximum Soldering Profile	265°C for 10 s	

SF2190B

**138 MHz
SAW Filter**

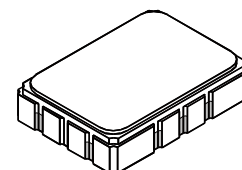

SMP-03

Electrical Characteristics

Characteristic	Sym	Notes	Min	Typ	Max	Units
Center Frequency	F_C			138		MHz
Insertion Loss	IL			18.8	21.0	dB
1 dB Bandwidth			60	63		MHz
3 dB Bandwidth				65.4		MHz
Amplitude Ripple Across 1 dB Bandwidth				0.6	1.2	dB _{p-p}
Upper -35 dB Band Edge				176	179	MHz
Lower -35 dB Band Edge			97	101		MHz
Ultimate Rejection			35	40		dB
Temperature Coefficient				-72		ppm/°C
Source Impedance, Balanced				50		ohm
Load Impedance, Balanced				50		ohm

Case Style	SMP-03 5 X 7 mm Nominal Footprint
Lid Symbolization (YY=year, WW=week, S=shift, ## = Sequence Code)	RFM, SF2190B, <u>YYWWS##</u>



CAUTION: Electrostatic Sensitive Device. Observe precautions for handling.

NOTES:

1. The design, manufacturing process, and specifications of this device are subject to change.
2. US or International patents may apply.
3. RoHS compliant from the first date of manufacture.

SF2190B Response, 38 to 238 MHz

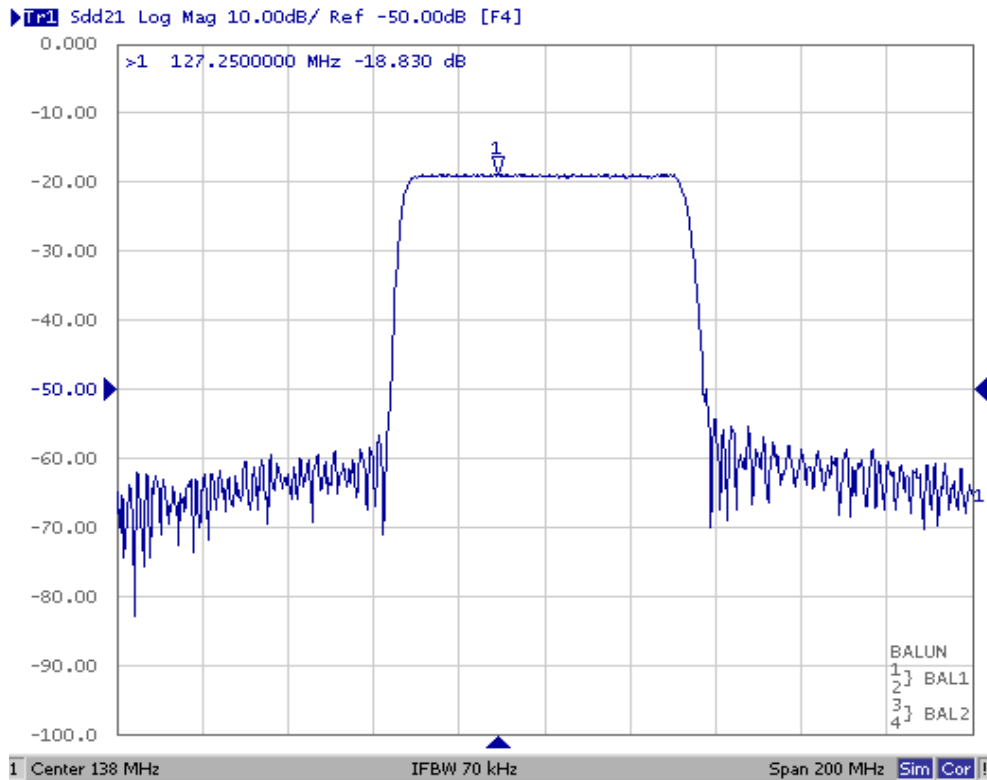

SF2190B Passband Response

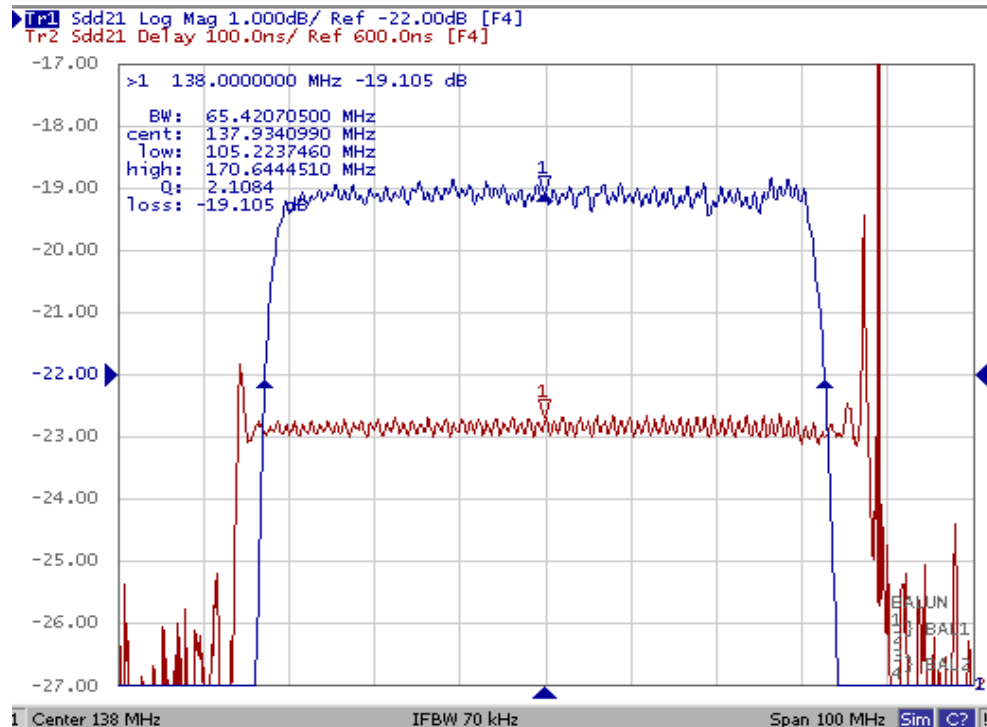

SF2190B Response, 300 kHz to 600 MHz

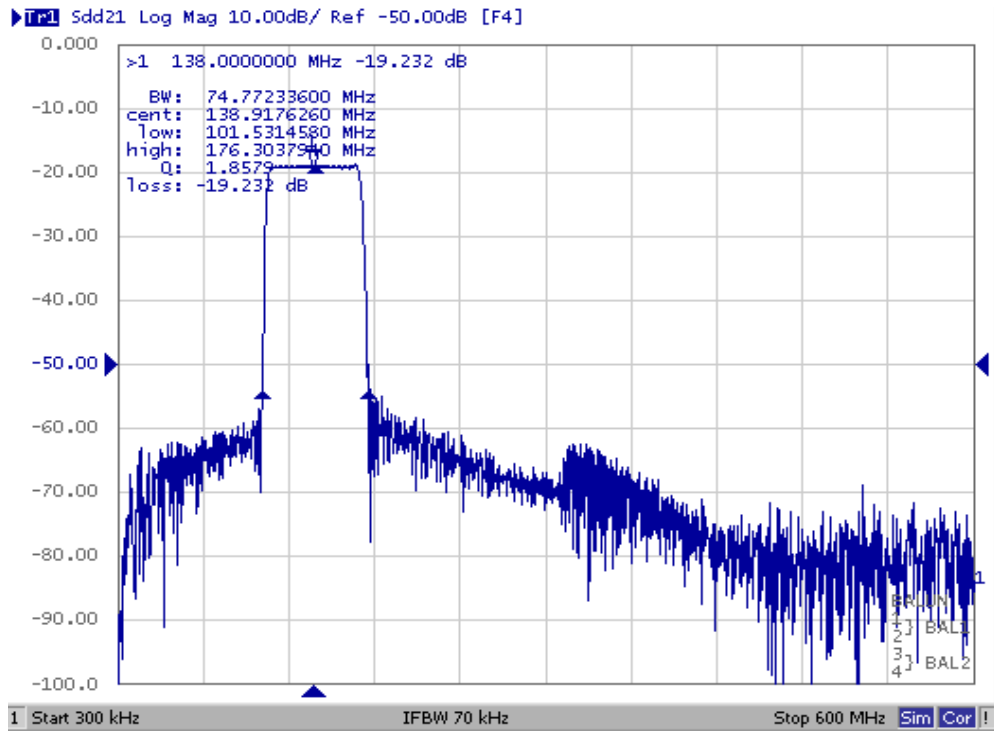

10-Terminal Ceramic Surface-Mount Case

5 x 7 mm Nominal Footprint

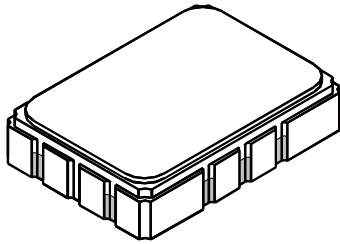

SMP-03 Package

Matching Network

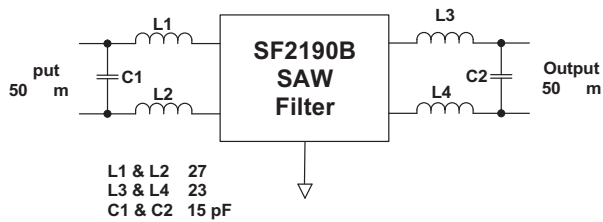

Case Dimensions

Dimension	mm			Inches		
	Min	Nom	Max	Min	Nom	Max
A	6.80	7.00	7.20	0.268	0.276	0.283
B	4.80	5.00	5.20	0.189	0.197	0.205
C		1.65	2.00		0.065	0.079
D		0.60			0.024	
E		2.54			0.100	
H		1.0			0.039	
J		5.00			0.197	
K		3.00			0.118	
P		1.27			0.050	

Electrical Connections

Connection		Terminals
Port 1	Balanced Input	10
	Balanced Input	1
Port 2	Balanced Output	5
	Balanced Output	6
Ground		All others

Case Materials

Materials	
Solder Pad Plating	0.3 to 1.0 μm Gold over 1.27 to 8.89 μm Nickel
Lid Plating	2.0 to 3.0 μm Nickel
Body	Al_2O_3 Ceramic

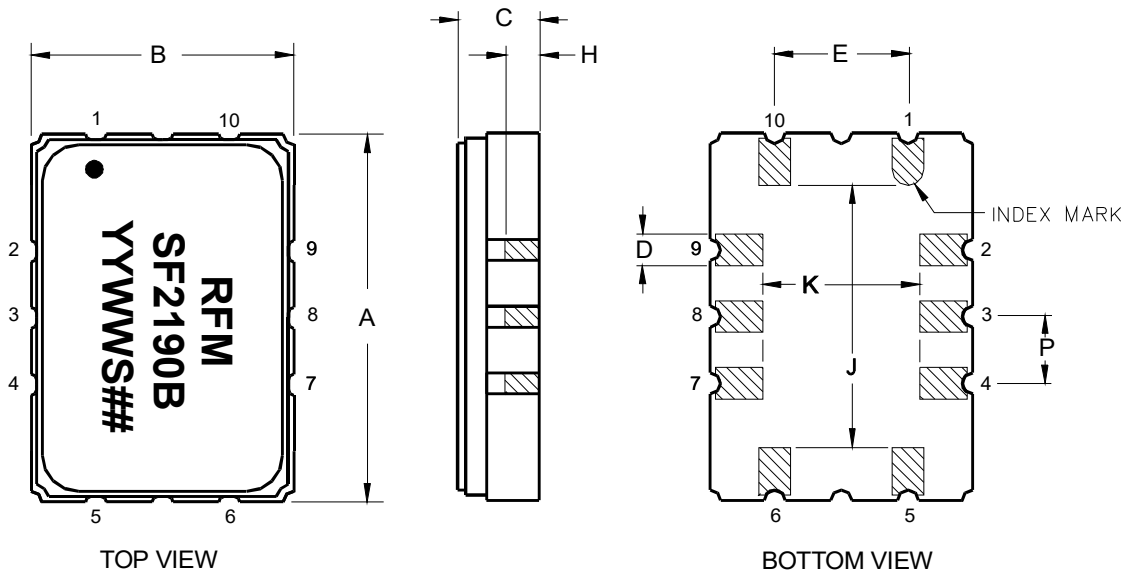

Tape and Reel Specifications

Tape and Reel Standard per ANSI/EIA-481

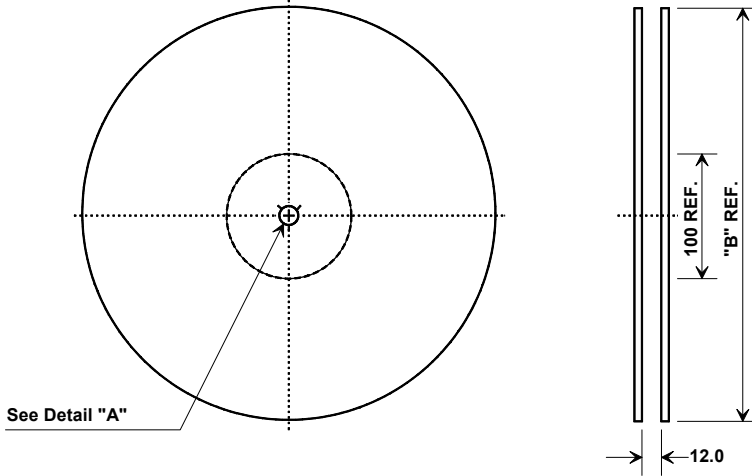

"B" Nominal Size		Quantity Per Reel
Inches	millimeters	
7	178	500
13	330	2000

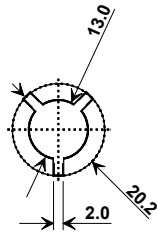

Component Orientation and Dimensions

Carrier Tape Dimensions	
Ao	9.4 mm
Bo	7.4 mm
Ko	2.0 mm
Pitch	8.0 mm
W	16.0 mm

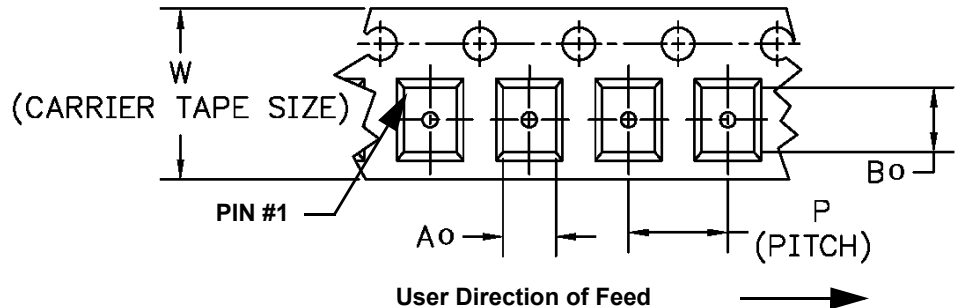
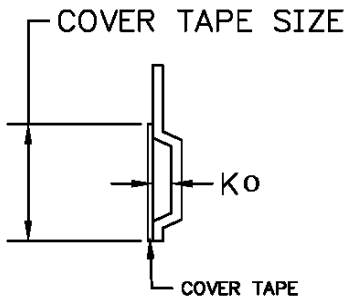

Recommended Reflow Profile

1. Preheating shall be fixed at 150~180°C for 60~90 seconds.
2. Ascending time to preheating temperature 150°C shall be 30 seconds min.
3. Heating shall be fixed at 220°C for 50~80 seconds and at 260°C+0/-5°C peak (10 seconds).
4. Time: 5 times maximum.

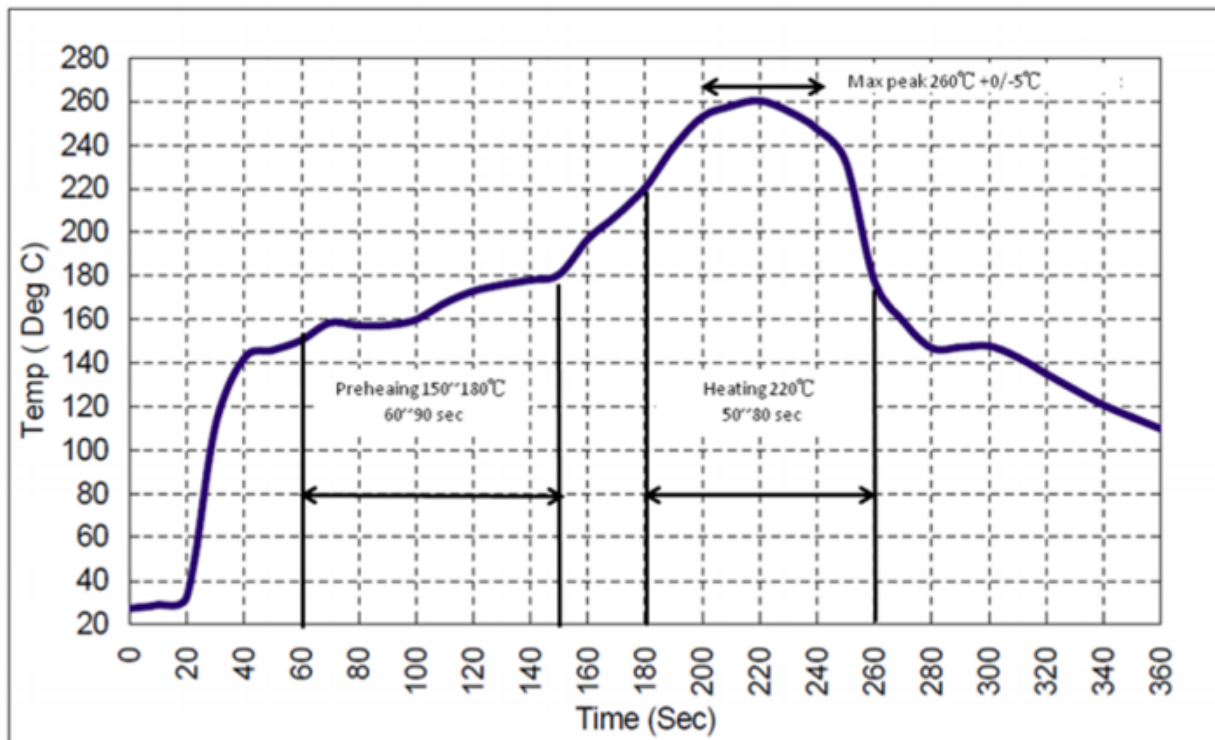

Looking for pricing, stock, or lifecycle information?

Click below to explore more details on WIN SOURCE:

 [View SF2190B on WIN SOURCE](#)

 [RF Monolithics, Inc Information](#)

Optimize Your Supply Chain with WIN SOURCE Solutions

-  Global Sourcing Solution
-  Obsolete Management
-  Cost Control Management
-  Shortage Management
-  Alternative Solution
-  Excess Inventory Management