



**THE DATASHEET OF  
SF2367B**



- 169.4375 MHz Narrow-band SAW Filter
- Steep Transition to Stopband
- Hermetic 5 X 7 mm Surface Mount Case
- Complies with Directive 2002/95/EC (RoHS)
- Moisture Sensitivity Level: 1

#### Absolute Maximum Ratings

Rating	Value	Units
Input Power	+10	dBm
DC Voltage on any Non-ground Terminal	5	VDC
Operating Temperature Range	-40 to +85	°C
Storage Temperature Range in Tape and Reel	-40 to +85	°C
Soldering profile - 2 cycles maximum	245 to 260°C for 10 s	

**SF2367B**

**169.4375 MHz  
SAW Filter**

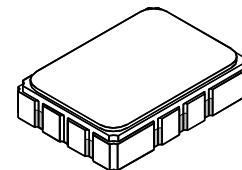

**SMP-03**

#### Electrical Characteristics

Characteristic	Sym	Notes	Min	Typ	Max	Units
3 dB Center Frequency	$F_C$		169.4075	169.4375	169.4675	MHz
Insertion Loss at Center Frequency IL <sub>C</sub>	IL <sub>C</sub>			3	4.5	dB
3 dB Bandwidth			80	100		kHz
Rejection: (reference to IL <sub>C</sub> )						dB
$F_C - 5\text{MHz}$ to $F_C - 0.9\text{MHz}$			40	60		
$F_C + 0.9\text{MHz}$ to $F_C + 0.92\text{MHz}$			38	45		
$F_C + 0.92\text{MHz}$ to $F_C + 4\text{MHz}$			40	50		
$F_C + 4\text{MHz}$ to $F_C + 5\text{MHz}$			50	60		

Case Style	SMP-03 5 x 7 mm Nominal Footprint
Lid Symbolization (YY=year, WW=week, S=shift, ## = Sequence Code)	RFM, SF2367B, YYWWS##

 **CAUTION: Electrostatic Sensitive Device. Observe precautions for handling.**

#### NOTES:

1. The design, manufacturing process, and specifications of this device are subject to change.
2. US or International patents may apply.
3. RoHS compliant from the first date of manufacture.

# Frequency Characteristics

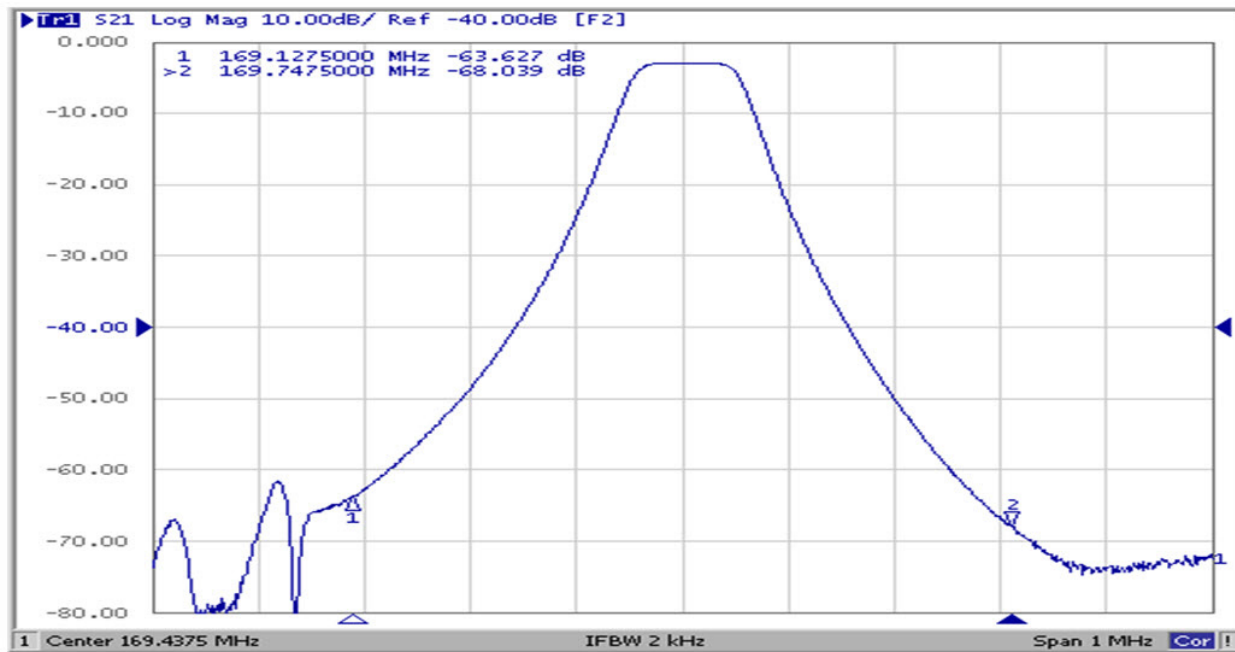
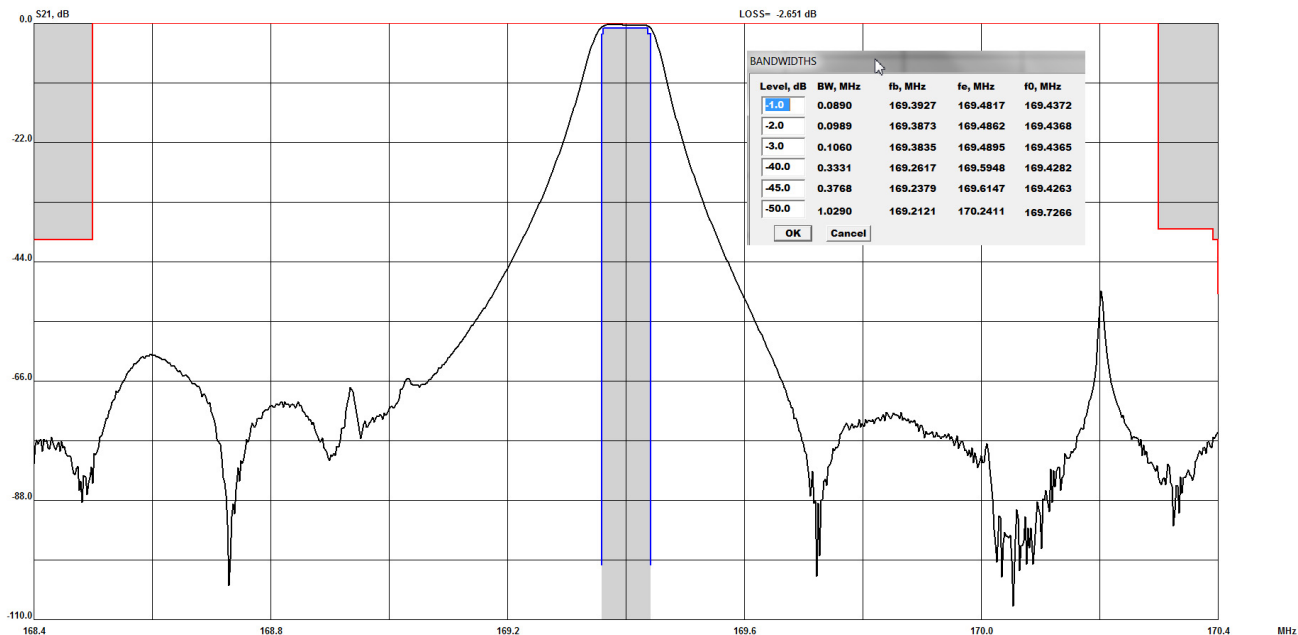

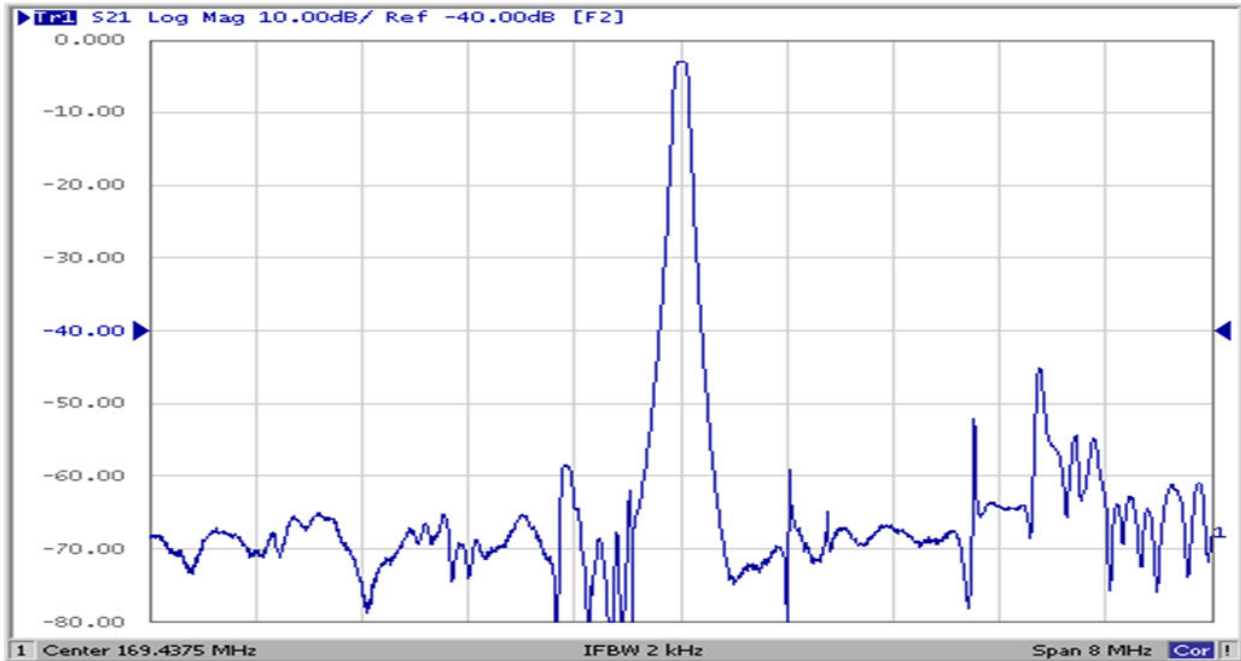

## Measurement Circuit

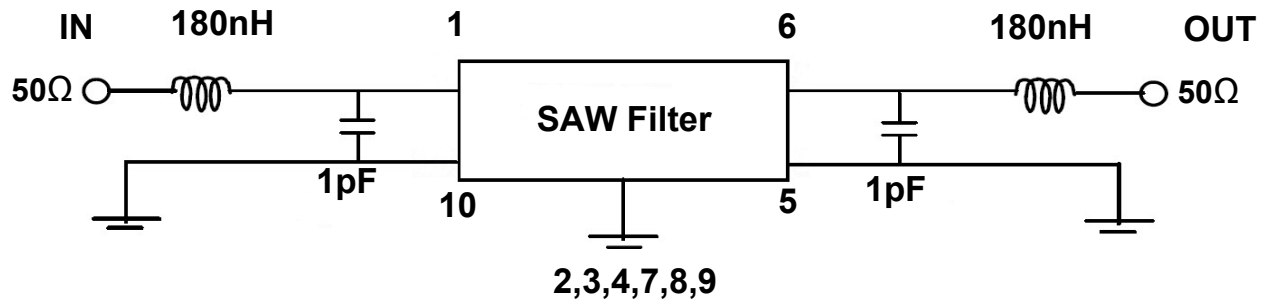

### Electrical Connections

Connection	Terminals
Input	1
Output	6
Balanced Input or Input Ground	10
Balanced Output or Output Ground	5
Ground	2,3,4,7,8,9

# SMP-03 Case

## 10-Terminal Ceramic Surface-Mount Case

### 5 x 7 mm Nominal Footprint

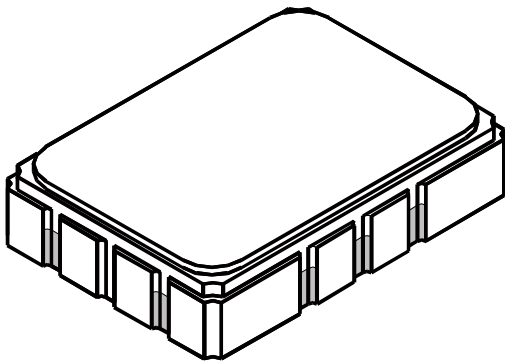

#### Case Dimensions

Dimension	mm			Inches		
	Min	Nom	Max	Min	Nom	Max
A	-	7.00	-	-	0.276	-
B	-	5.00	-	-	0.197	-
C	-	-	1.80	-	-	0.070
D	-	5.00	-	-	0.197	-
E	-	2.54	-	-	0.100	-
F	-	1.00	-	-	0.039	-
G	-	0.30	-	-	0.011	-
H	-	1.27	-	-	0.050	-
I	-	2.54	-	-	0.100	-
J	-	0.60	-	-	0.024	-

#### Case Materials

Materials	
Solder Pad Plating	0.3 to 1.0 $\mu\text{m}$ Gold over 1.27 to 8.89 $\mu\text{m}$ Nickel
Lid Plating	2.0 to 3.0 $\mu\text{m}$ Nickel
Body	$\text{Al}_2\text{O}_3$ Ceramic

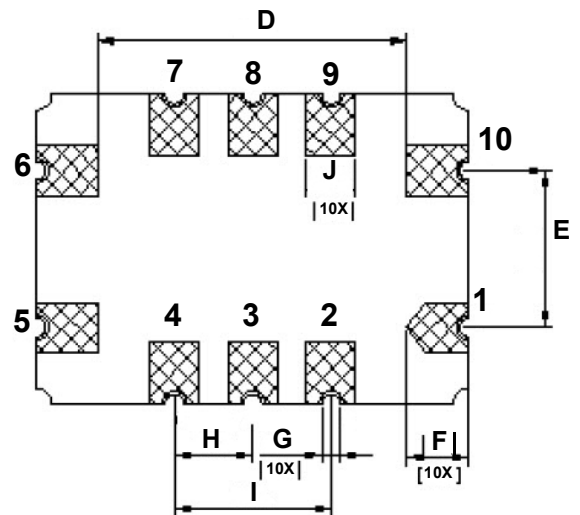
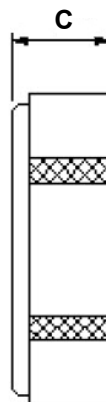
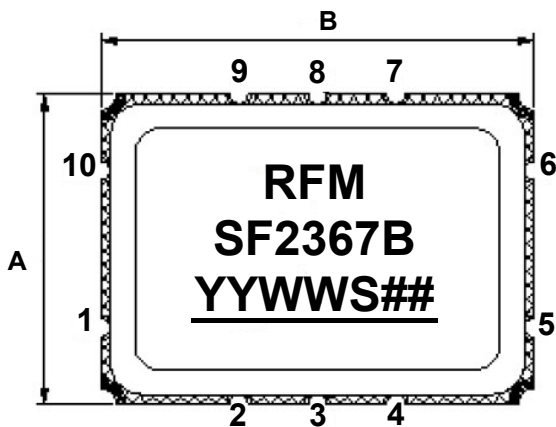

## Tape and Reel Specifications

Tape and Reel Standard per ANSI/EIA-481

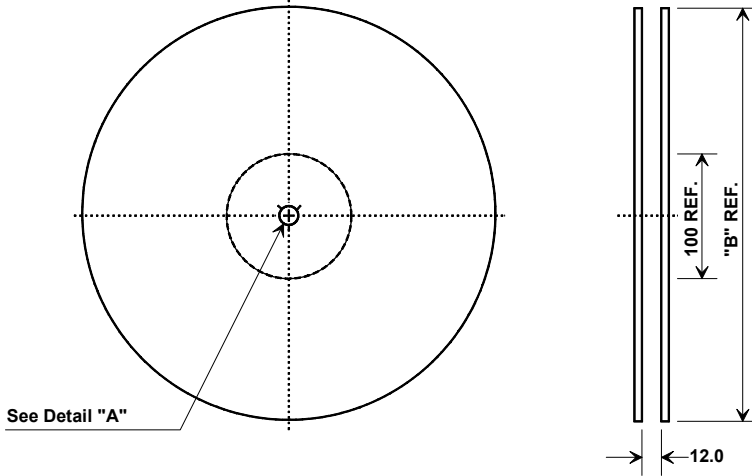

"B"		Quantity Per Reel
Nominal Size		
Inches	millimeters	
7	178	500
13	330	2000

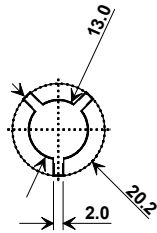

### COMPONENT ORIENTATION and DIMENSIONS

Carrier Tape Dimensions	
Ao	5.6 ± 0.1 mm
Bo	7.6 mm
Ko	1.9 ± 0.1 mm
Pitch	8.0 ± 0.1 mm
W	16.0 ± 0.3 mm

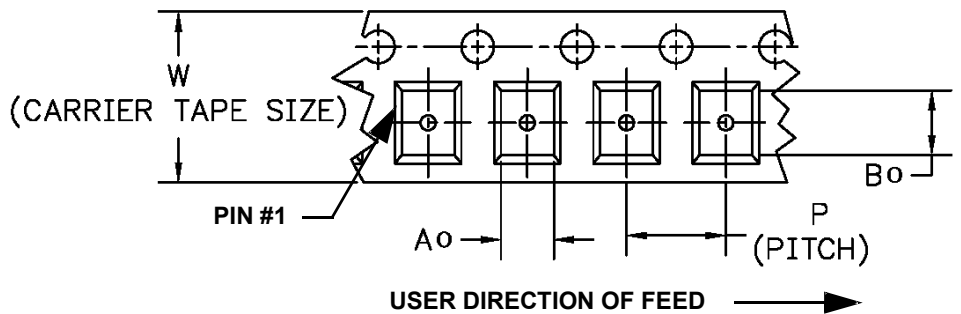
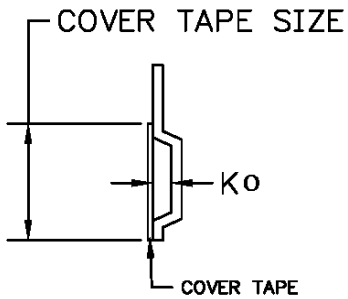

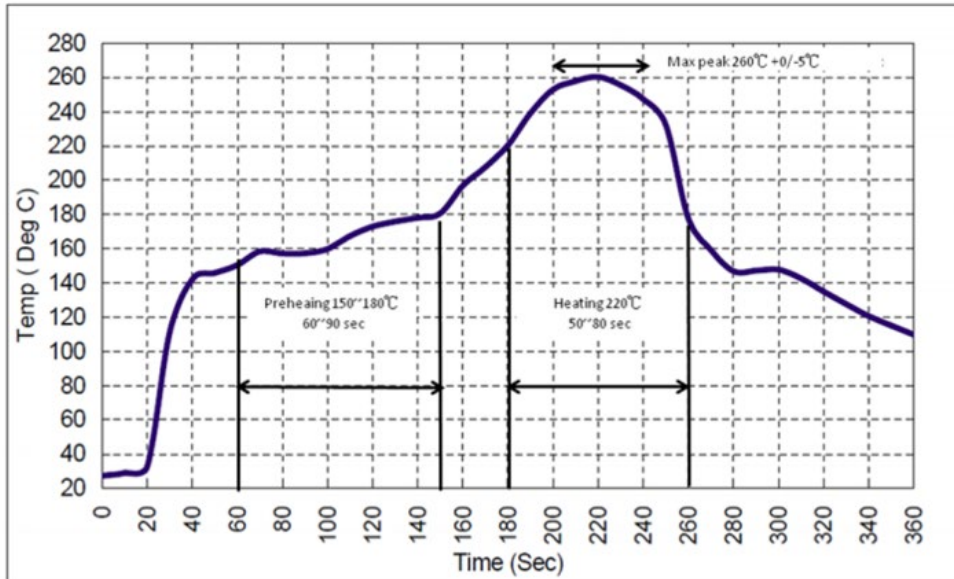

## Recommended Reflow Profile

1. Preheating shall be fixed at 150~180°C for 60~90 seconds.
2. Ascending time to preheating temperature 150°C shall be 30 seconds min.
3. Heating shall be fixed at 220°C for 50~80 seconds and at 260°C +0/-5°C peak (10 seconds).
4. Time: 5 times maximum.



## Looking for pricing, stock, or lifecycle information?

Click below to explore more details on WIN SOURCE:

-  [View SF2367B on WIN SOURCE](#)
-  [RF Monolithics, Inc Information](#)

## Optimize Your Supply Chain with WIN SOURCE Solutions

-  Global Sourcing Solution
-  Obsolete Management
-  Cost Control Management
-  Shortage Management
-  Alternative Solution
-  Excess Inventory Management