



THE DATASHEET OF SF2445E



- **RF Filter for Mobile Communication Applications**
- **Low Insertion Loss**
- **3.0 x 3.0 x 1.3 mm Surface-Mount Case**
- **Complies with Directive 2002/95/EC (RoHS)**
- **Moisture Sensitivity Level: 1**
- **AEC-Q200 Qualified**

Absolute Maximum Ratings

Rating	Value	Units
Maximum Incident Power in Passband	+15	dBm
Maximum DC Voltage Between any 2 Terminals	3	VDC
Operable Temperature Range	-45 to +125	°C
Specification Temperature Range	-30 to +85	°C
Storage Temperature Range	-40 to +85	°C
Terminating Source Impedance (single) Z_S	50	Ω
Terminating Load Impedance (single) Z_L	50	Ω
Maximum Soldering Profile	260 °C for 10 s	

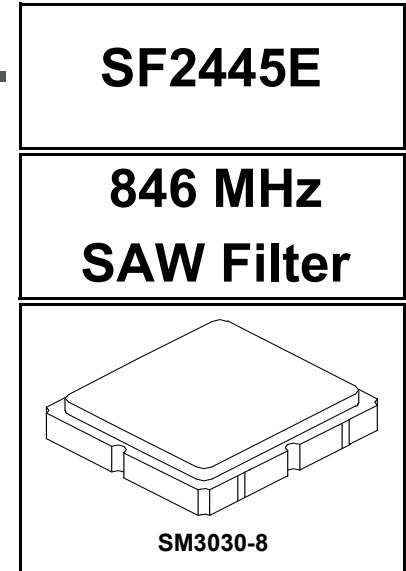

Characteristic	Sym	Notes	Min	Typ	Max	Units
Center Frequency	f_c			846		MHz
3dB Bandwidth			1.23	1.7		MHz
Total Amplitude Variation, 845.385 to 846.615 MHz				2.5	4.7	dB
Minimum Insertion Loss				8.0	10.5	
Input VSWR, 845.385 to 846.615 MHz				4.7	6.3	
Output VSWR, 845.385 to 846.615 MHz				2.1	3.8	
Phase Deviation (845.385 to 846.615 MHz RMS))				2	5	deg.
Attenuation Referenced to IL min:	IL					dB
0.1 to 841 MHz			40	45		
841 to 844.28 MHz			19	25		
849 to 1000 MHz			35	38		
Case Style	SM3030-8 3 x 3 mm Nominal Footprint					
Lid Symbolization (Y=year, WW=week, S=shift)	9B, <u>YWWS</u>					

 **CAUTION: Electrostatic Sensitive Device. Observe precautions for handling.**
NOTES:

1. The design, manufacturing process, and specifications of this device are subject to change.
2. US or International patents may apply.
3. RoHS compliant from the first date of manufacture.

Electrical Connections

Connection	Terminals
Input	3
Output	7
Ground	All others

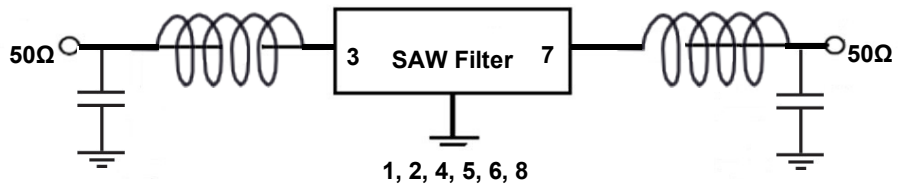

Frequency Characteristics

Narrow Band Response

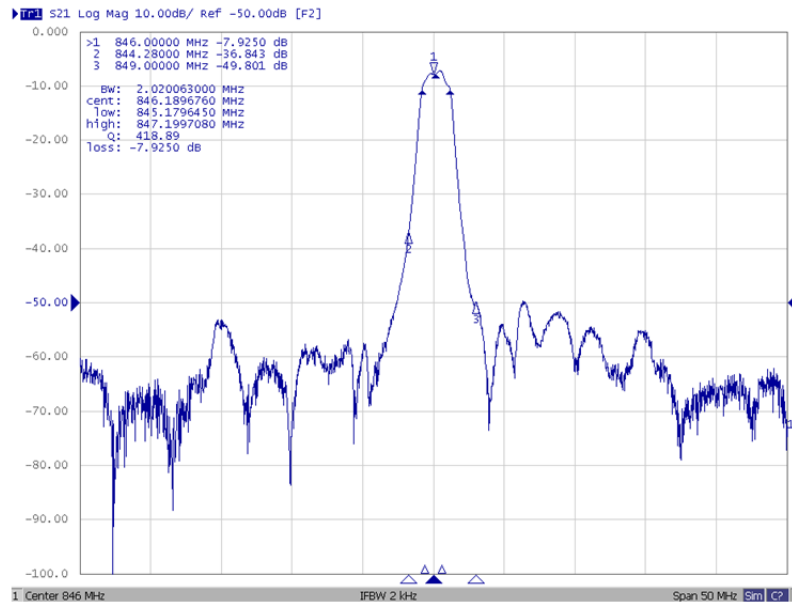

Pass Band and Group Time Delay Response

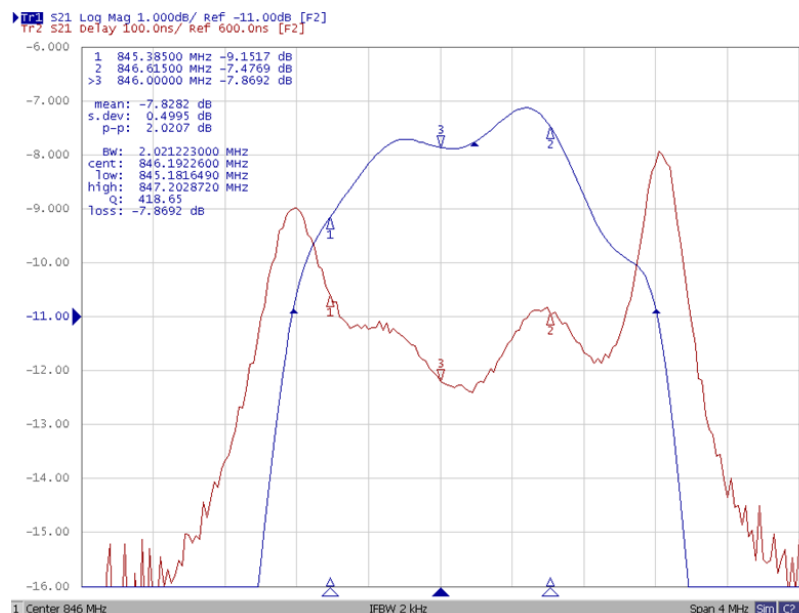

Frequency Characteristics (cont.)

VSWR

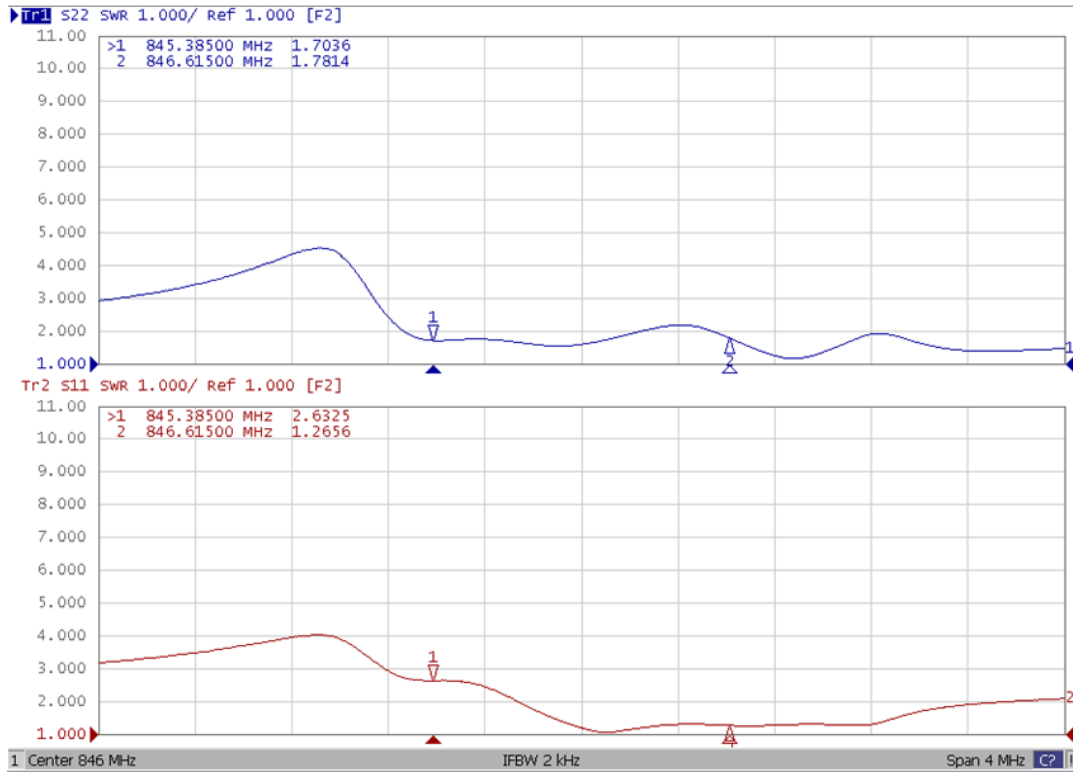

Wide Band Response

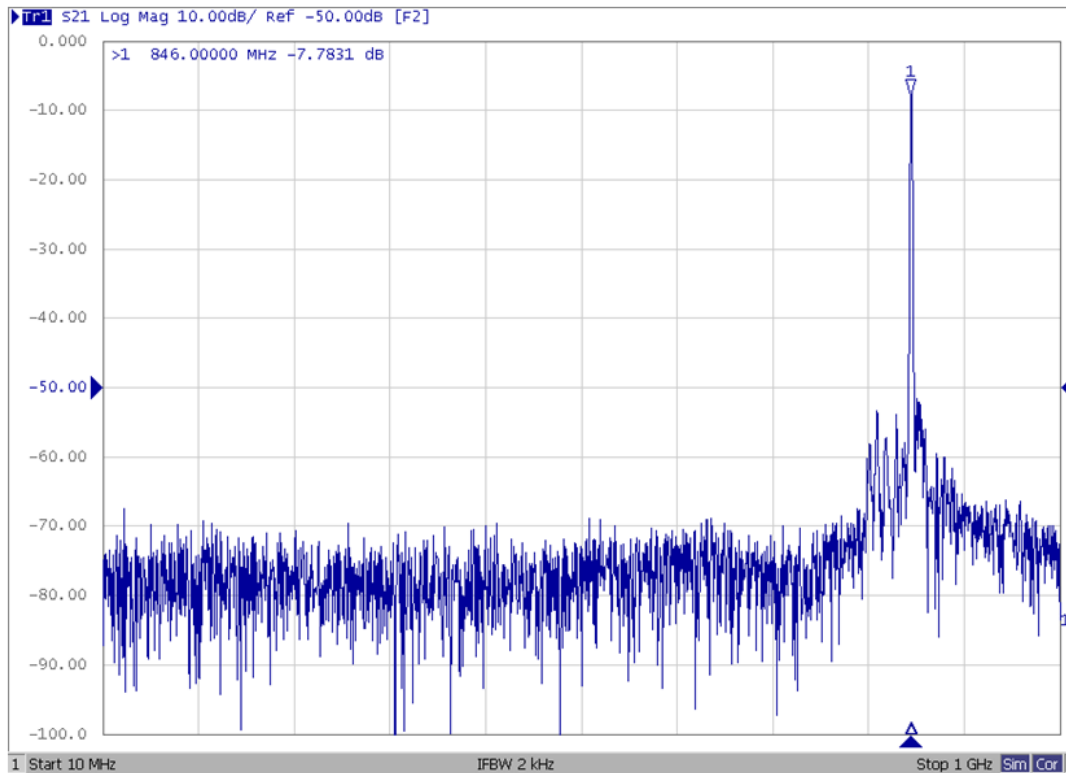

Frequency Characteristics (cont.)

Smith Chart

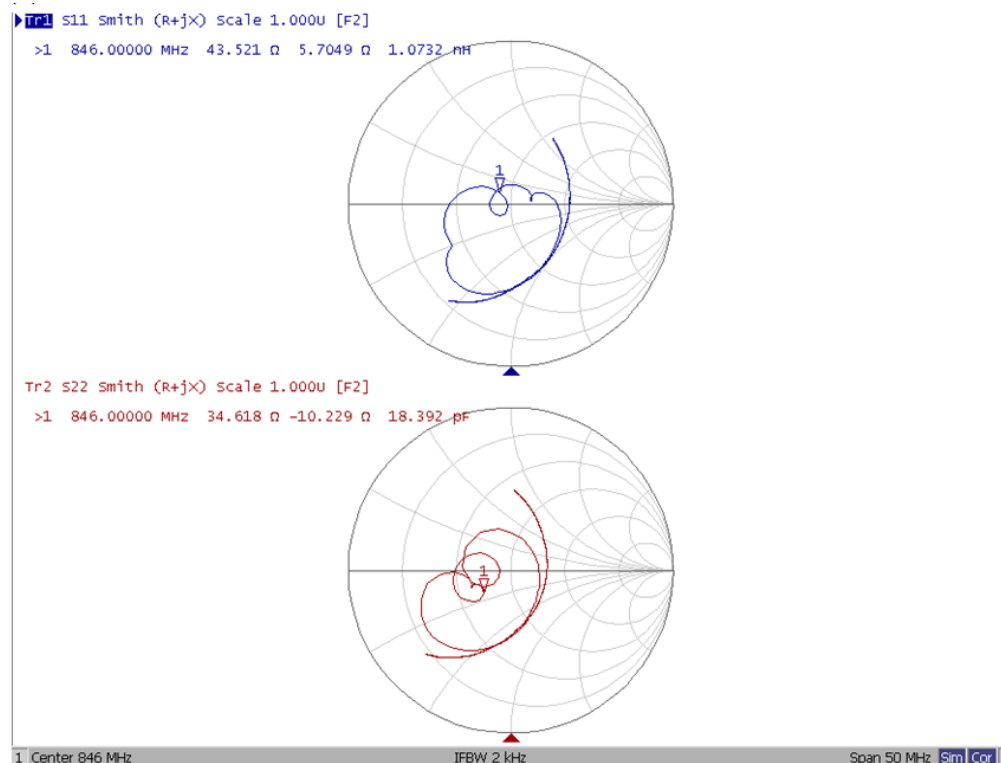

Phase

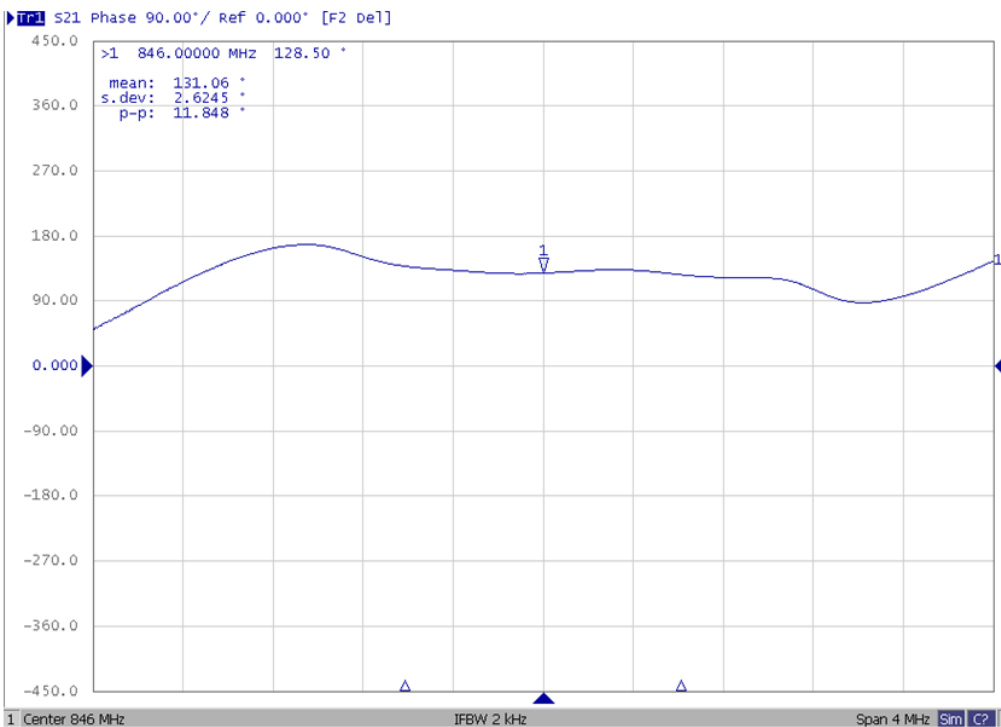

SM3030-8 Case

8-Terminal Ceramic Surface-Mount Case

3.0 X 3.0 mm Nominal Footprint

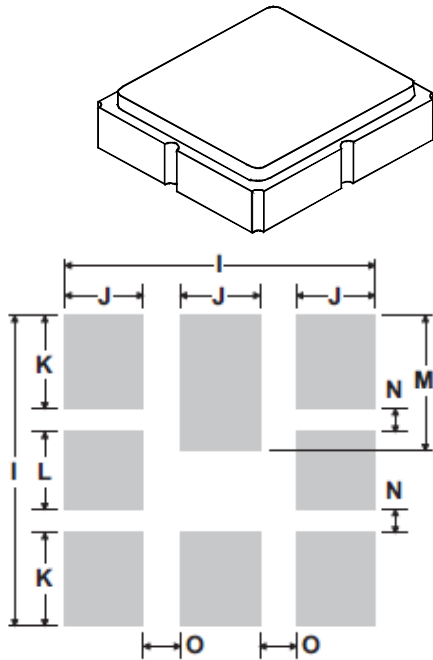

PCB Footprint, Top View

Case Dimensions

Dimension	mm			Inches		
	Min	Nom	Max	Min	Nom	Max
A	2.87	3.0	3.13	0.113	0.118	0.123
B	2.87	3.0	3.13	0.113	0.118	0.123
C	1.14	1.27	1.40	0.045	0.050	0.055
D	0.79	0.92	1.05	0.031	0.036	0.041
E	0.62	0.75	0.88	0.024	0.029	0.034
F	0.47	0.60	0.73	0.018	0.024	0.029
G	0.47	0.60	0.73	0.018	0.024	0.029
H	1.07	1.20	1.33	0.042	0.047	0.052
I		3.19			0.126	
J		0.81			0.032	
K		0.96			0.038	
L		0.81			0.032	
M		1.39			0.055	
N		0.23			0.009	
O		0.38			0.015	

Case Materials

Materials	
Solder Pad Plating	0.3 to 1.0 μm Gold over 1.27 to 8.89 μm Nickel
Lid Plating	2.0 to 3.0 μm Nickel
Body	Al_2O_3 Ceramic

TOP VIEW

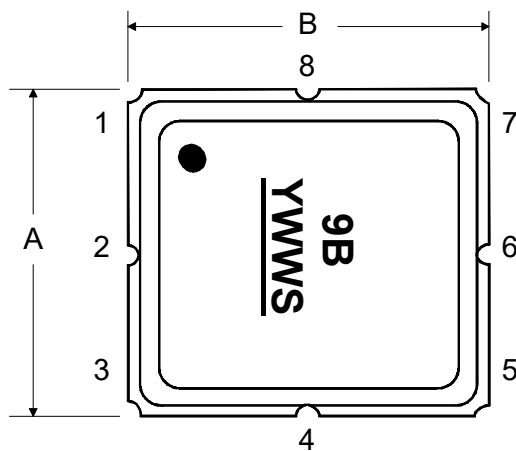

BOTTOM VIEW

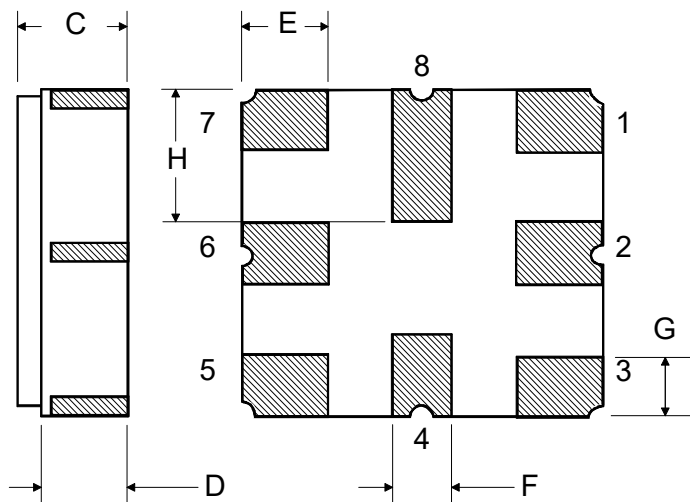

Tape and Reel Specifications

Tape and Reel Standard per ANSI/EIA-481

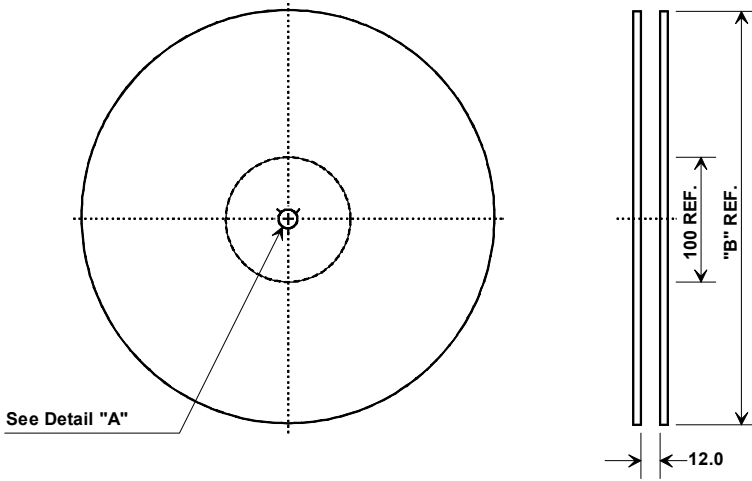

"B"		Quantity Per Reel
Inches	millimeters	
7	178	500
13	330	3000

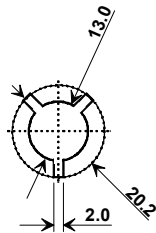

COMPONENT ORIENTATION and DIMENSIONS

Carrier Tape Dimensions	
Ao	4.25 mm
Bo	4.25 mm
Ko	1.3 mm
Pitch	8.0 mm
W	12.0 mm

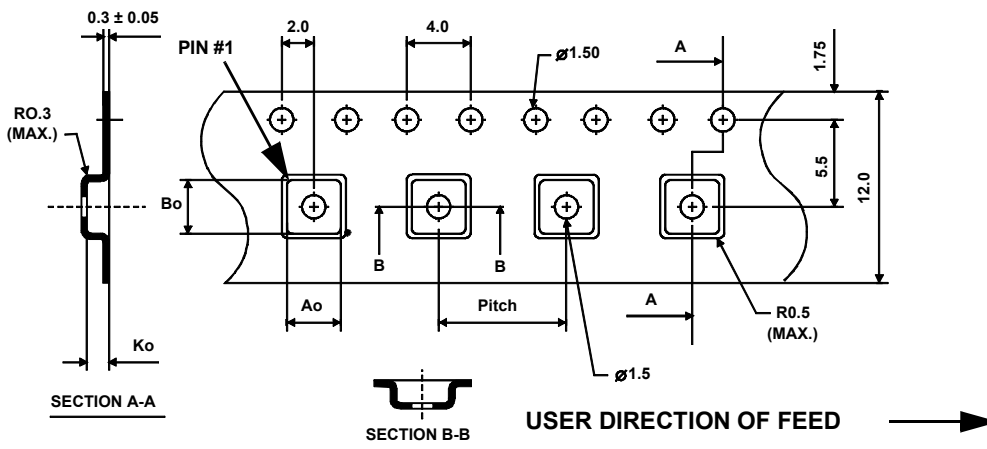

Recommended Reflow Profile

1. Preheating shall be fixed at 150~180°C for 60~90 seconds.
2. Ascending time to preheating temperature 150°C shall be 30 seconds min.
3. Heating shall be fixed at 220°C for 50~80 seconds and at 260°C +0/-5°C peak (10 seconds).
4. Time: 5 times maximum.

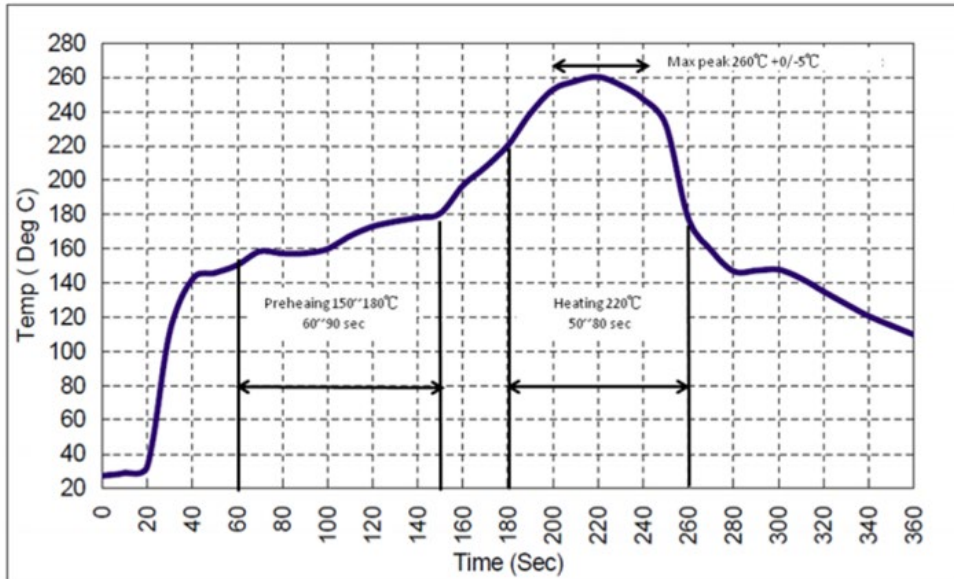

Looking for pricing, stock, or lifecycle information?

Click below to explore more details on WIN SOURCE:

 [View SF2445E on WIN SOURCE](#)

 [RF Monolithics, Inc Information](#)

Optimize Your Supply Chain with WIN SOURCE Solutions

-  Global Sourcing Solution
-  Obsolete Management
-  Cost Control Management
-  Shortage Management
-  Alternative Solution
-  Excess Inventory Management