

- **Steep Roll-off SAW Filter for 869.00 MHz Unlicensed Band**
- **No Matching Required for Operation in 50Ω Environment**
- **Complies with Directive 2002/95/EC (RoHS)**
- **Moisture Sensitivity Level: 1**

SF2137E-2

**869.00 MHz
SAW Filter**

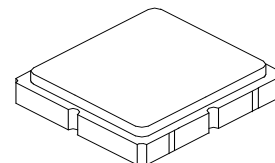

SM3030-6

A1 Maximum Ratings

Rating	Value	Units
Input Power Level	13	dBm
DC Voltage on any Non-ground Terminal	5	V
Operable Temperature	-45 to +125	°C
Storage Temperature Range in Tape and Reel	-40 to +85	°C
Soldering Profile Maximum Temperature, 5 cycles/10 s maximum	265	°C

B1 Electrical Characteristics

Operating Temperature Range -40°C to +85°C

Characteristic	Sym	Notes	Min	Typ	Max	Units
Center Frequency	f_C			869.00		MHz
Insertion Loss, 868 to 870 MHz	IL			2.3	3.0	dB
Amplitude Ripple, 868 to 870 MHz				0.3	0.6	dB _{p-p}
Attenuation Referenced to 0 dB:						
100 to 300 MHz			45	50		dB
300 to 845 MHz			40	45		
845 to 853 MHz			38	43		
879 to 883 MHz			15	30		
883 to 915 MHz			40	45		
915 to 945 MHz			45	50		
945 to 1200 MHz			45	55		
1200 to 2000 MHz			35	40		
Source Impedance	Z_S			50		Ω
Load Impedance	Z_L			50		Ω
Case Style	SM3030-6 3.0 x 3.0 mm Nominal Footprint					
Lid Symbolization, Y=year, WW=week, S=shift, Dot=pin 1 indicator	B16, <u>Y</u> WWS					

Electrical Connections

Connection	Terminals
Port 1 (Input)	2
Port 2 (Output)	5
Case Ground	All others

Test Circuit

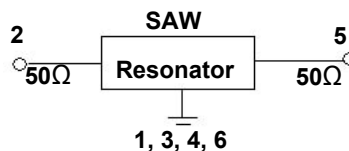

CAUTION: Electrostatic Sensitive Device. Observe precautions for handling.

NOTES:

1. The design, manufacturing process, and specifications of this device are subject to change.
2. US or International patents may apply.
3. RoHS compliant from the first date of manufacture.

A2 Maximum Ratings

Rating	Value	Units
Input Power Level	13	dBm
DC Voltage on any Non-ground Terminal	5	V
Operable Temperature	-45 to +125	°C
Storage Temperature Range in Tape and Reel	-40 to +85	°C
Soldering Profile Maximum Temperature, 5 cycles/10 s maximum	265	°C

B2 Electrical Characteristics

Operating Temperature Range -20°C to +70°C

Characteristic	Sym	Notes	Min	Typ	Max	Units
Center Frequency	f_C			869.00		MHz
Insertion Loss, 868 to 870 MHz	IL			2.3	3.0	dB
Amplitude Ripple, 868 to 870 MHz				0.3	0.6	dB _{P-P}
Attenuation Referenced to 0 dB:						
100 to 300 MHz			45	50		dB
300 to 845 MHz			40	45		
845 to 853 MHz			38	43		
879 to 883 MHz			20	30		
883 to 915 MHz			40	45		
915 to 945 MHz			45	50		
945 to 1200 MHz			45	55		
1200 to 2000 MHz			35	40		
Source Impedance	Z_S			50		Ω
Load Impedance	Z_L			50		Ω

Electrical Connections

Connection	Terminals
Port 1 (Input)	2
Port 2 (Output)	5
Case Ground	All others

Test Circuit

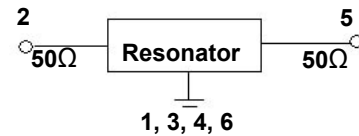

Frequency Characteristics

S21 Response: (Span 200 MHz)

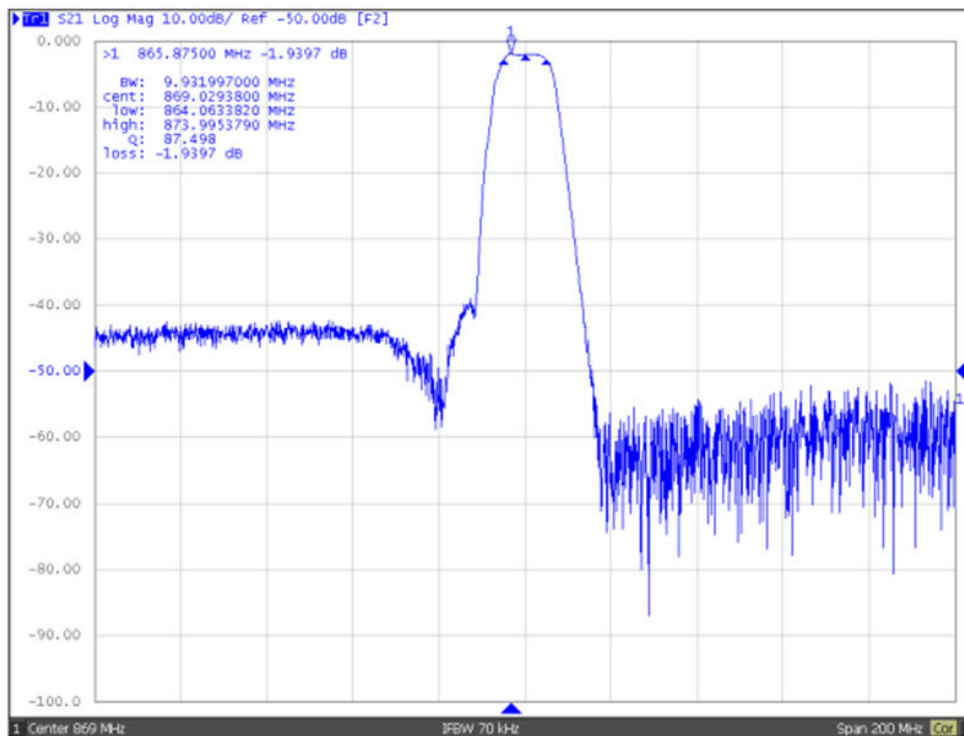

S21 Response: (Span 100 MHz)

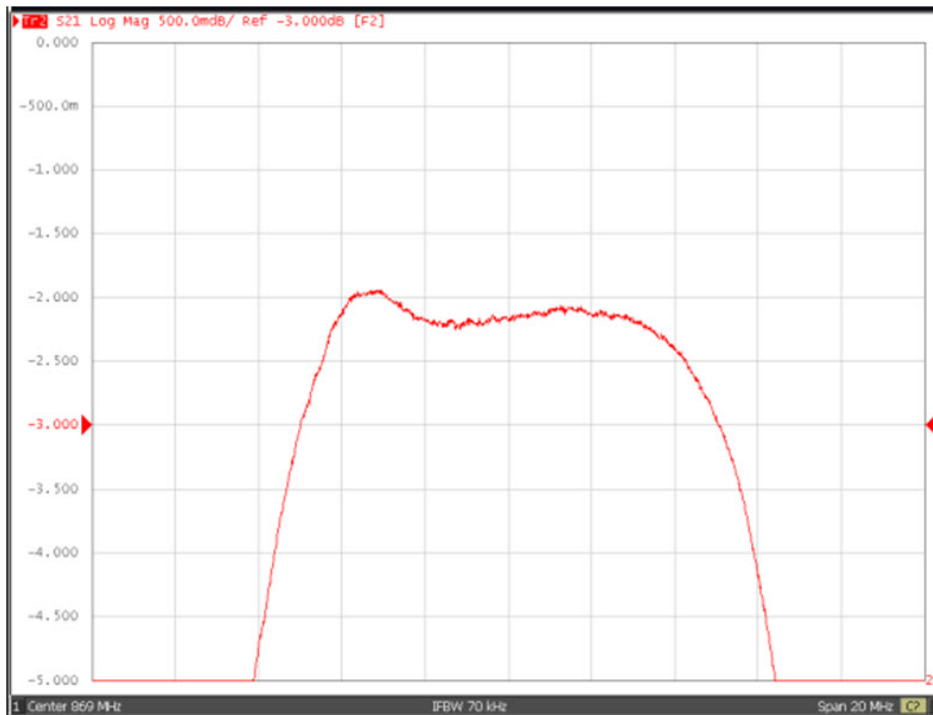

S21 Response: (Span 100 MHz)

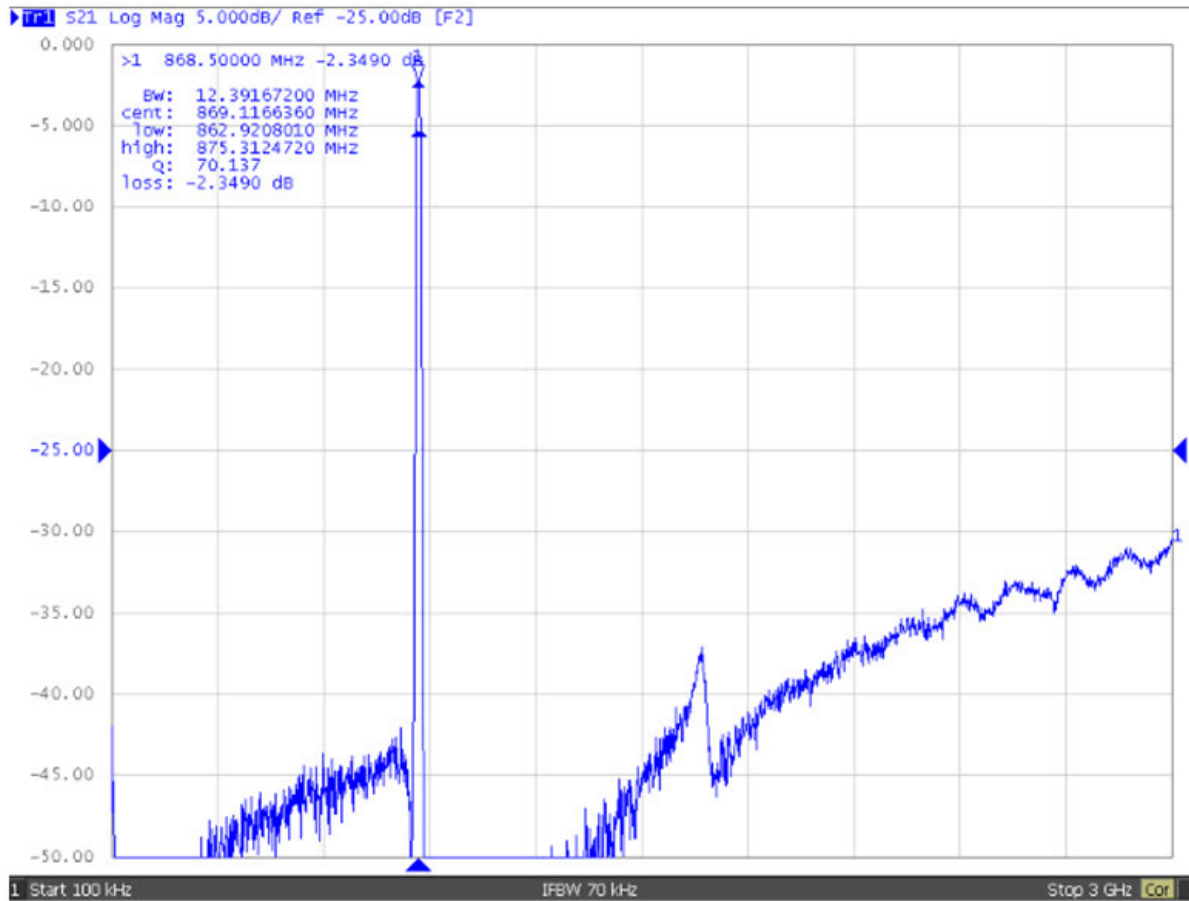

S11/S22 Response:

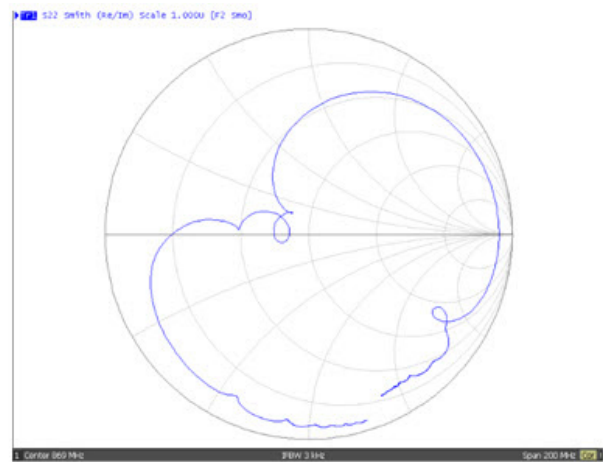
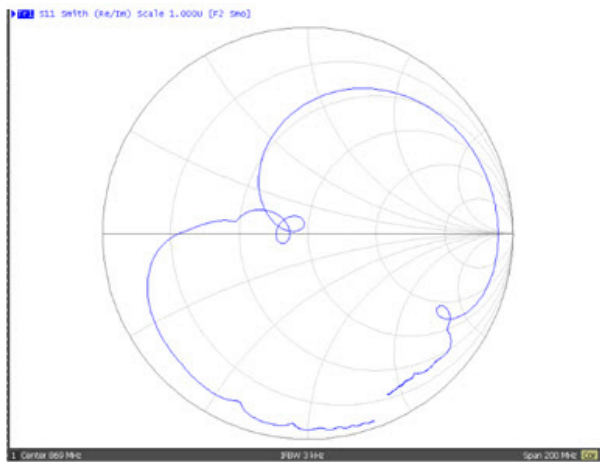

SM3030-6 Case

6-Terminal Ceramic Surface-Mount Case 3.0 X 3.0 mm Nominal Footprint

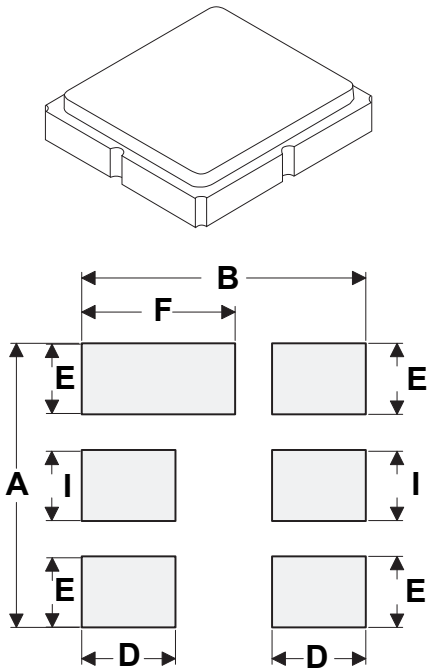

PCB Footprint Top View

Case and PCB Footprint Dimensions

Dimension	mm			Inches		
	Min	Nom	Max	Min	Nom	Max
A	2.85	3.00	3.15	0.112	0.118	0.124
B	2.85	3.00	3.15	0.112	0.118	0.124
C	1.12	1.25	1.40	0.044	0.049	0.055
D	0.60	0.75	0.90	0.023	0.029	0.035
E	0.38	0.53	0.68	0.014	0.020	0.026
F	1.05	1.20	1.35	0.041	0.047	0.053
G		0.15			0.005	
H		0.45			0.017	
I	0.55	0.60	0.65	0.021	0.023	0.025

Case Materials

Materials	
Solder Pad Plating	0.3 to 1.0 μ m Gold over 1.27 to 8.89 μ m Nickel
Lid Plating	2.0 to 3.0 μ m Nickel
Body	Al ₂ O ₃ Ceramic

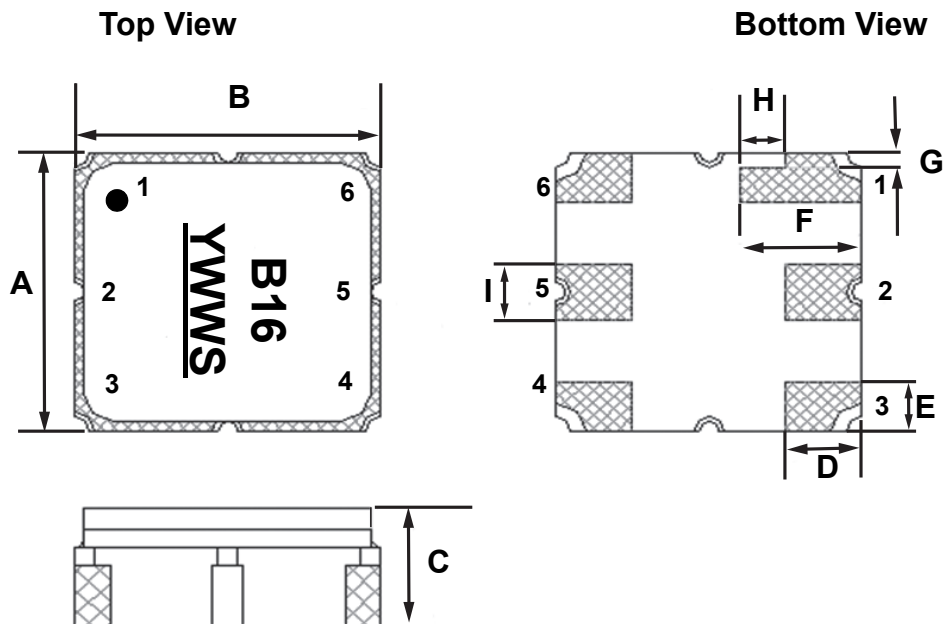

Tape and Reel Specifications

Tape and Reel Standard per ANSI/EIA-481

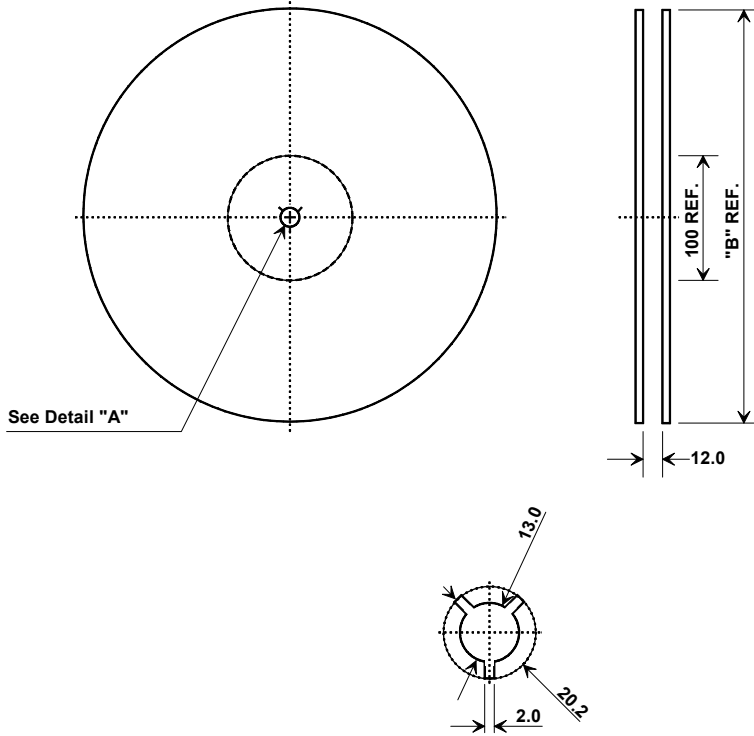

"B"		Quantity Per Reel
Inches	millimeters	
7	178	500
13	330	3000

COMPONENT ORIENTATION and DIMENSIONS

Carrier Tape Dimensions	
Ao	4.25 mm
Bo	4.25 mm
Ko	1.30 mm
Pitch	8.0 mm
W	12.0 mm

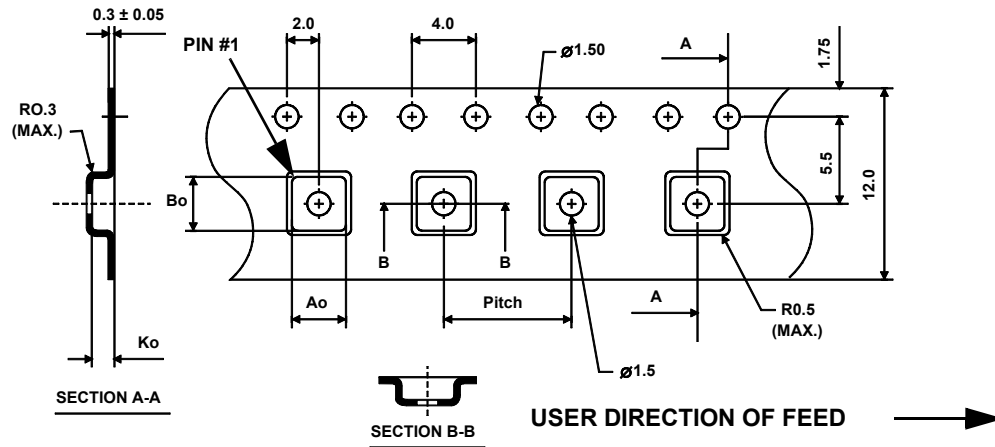

Recommended Reflow Profile

1. Preheating shall be fixed at 150~180°C for 60~90 seconds.
2. Ascending time to preheating temperature 150°C shall be 30 seconds min.
3. Heating shall be fixed at 220°C for 50~80 seconds and at 260°C +0/-5°C peak (10 seconds).
4. Time: 5 times maximum.

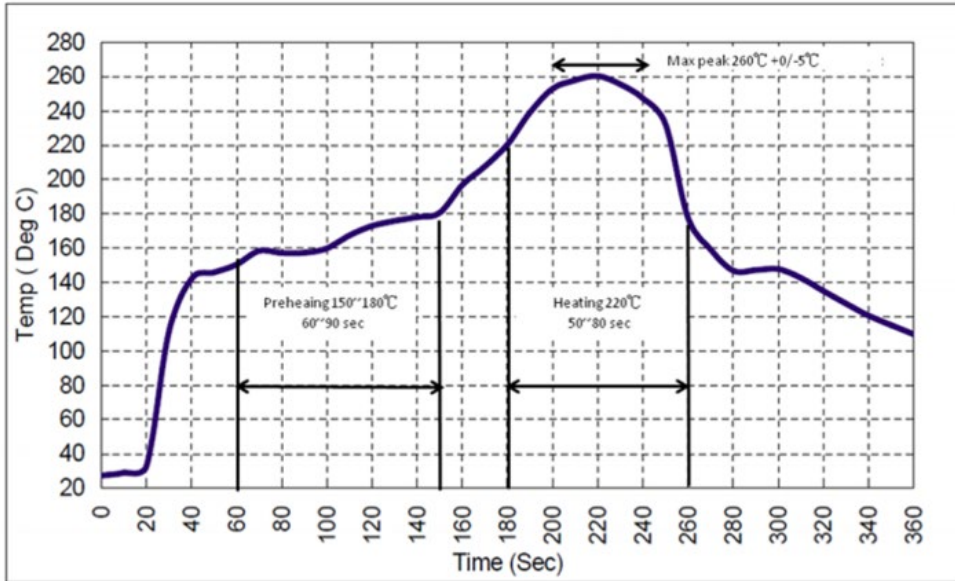

Looking for pricing, stock, or lifecycle information?

Click below to explore more details on WIN SOURCE:

 [View SF2137E-2 on WIN SOURCE](#)

 [RF Monolithics, Inc Information](#)

Optimize Your Supply Chain with WIN SOURCE Solutions

-  Global Sourcing Solution
-  Obsolete Management
-  Cost Control Management
-  Shortage Management
-  Alternative Solution
-  Excess Inventory Management