



THE DATASHEET OF SF2480E



- Complies with Directive 2002/95/EC (RoHS)
- Moisture Sensitivity Level: 1

Absolute Maximum Ratings

Rating	Value	Units
Input Power Level	+10	dBm
DC Voltage on any Non-ground Terminal	4	V
Operable Temperature Range	-45 to +125	°C
Specification Temperature Range	-40 to +25 +25 to +125	°C
Storage Temperature Range in Tape and Reel	-40 to +85	°C
Moisture Sensitivity Level	1	MSL
Solder Reflow Temperature, 5 Cycles Maximum	260°C for 10 Seconds	

SF2480E

**870.5 MHz
SAW Filter**

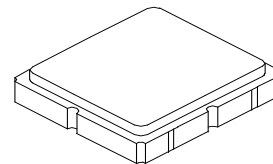

SM3030-6

Electrical Characteristics

Characteristic	Sym	Min	Typ	Max	Min	Typ	Max	Units
Specification Temperature Range		-40 to +25			+25 to +125			°C
Center Frequency	f_c	870.5			870.5			MHz
Insertion Loss	IL		865-872 MHz	3.4	6.5	3.4	4.0	dB
			872-875 MHz	3.0	3.6	3.0	15	
			875-876 MHz	3.5	4.6	3.5	20	
Amplitude Ripple (865-872 MHz)	p-p		0.9	1.6	0.9	1.6		
VSWR (865-872 MHz)			1.7	2.7	1.7	2.2		
Attenuation, reference to maximum IL in passband								dB
100 to 815 MHz		35	40		35	40		
815 to 832 MHz		34	39		34	39		
832 to 848 MHz		35	40		35	40		
848 to 860 MHz		8	19		2.5	19		
860 to 862 MHz		2.5	8		2.5	8		
880 to 886 MHz		2.5	18		8	18		
886 to 915 MHz		34	45		34	45		
915 to 1000 MHz		42	49		42	49		
Temperature Coefficient of Frequency			-36			-36		ppm/°C

Case Style	SMD 3.0 x 3.0 mm Nominal Footprint
Lid Symbolization (Y=year, WW=week, S=shift) dot=pin 1 indicator	C6, YWWS
Nominal Impedance	50Ω

Electrical Connections

Connection	Terminals
Input	2
Output	5
Ground	All Others

Measurement Circuit

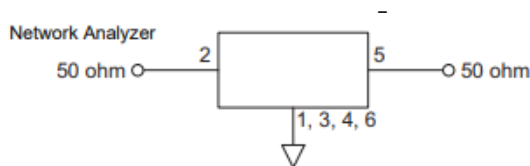

CAUTION: Electrostatic Sensitive Device. Observe precautions for handling.

NOTES:

1. The design, manufacturing process, and specifications of this device are subject to change.
2. US or International patents may apply.
3. RoHS compliant from the first date of manufacture.

Frequency Characteristics:

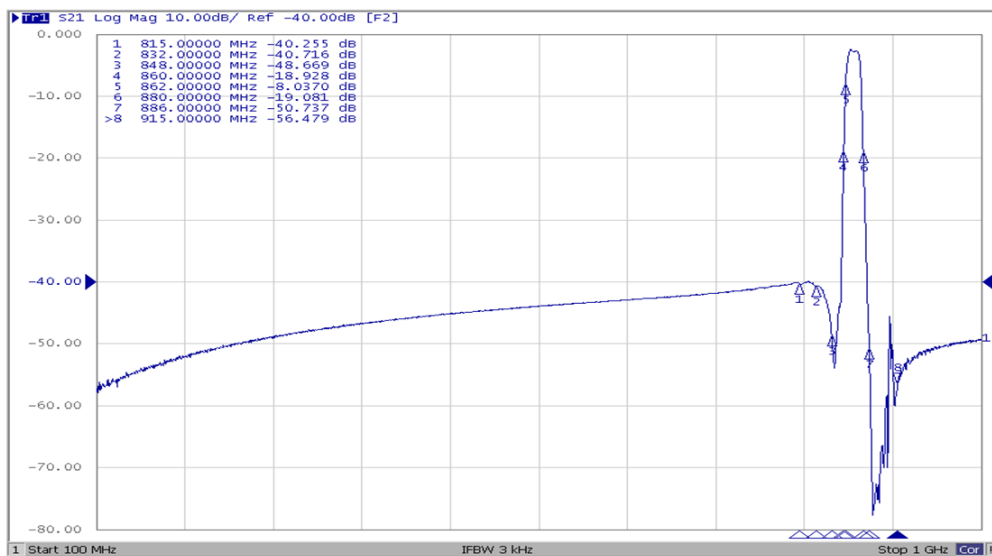
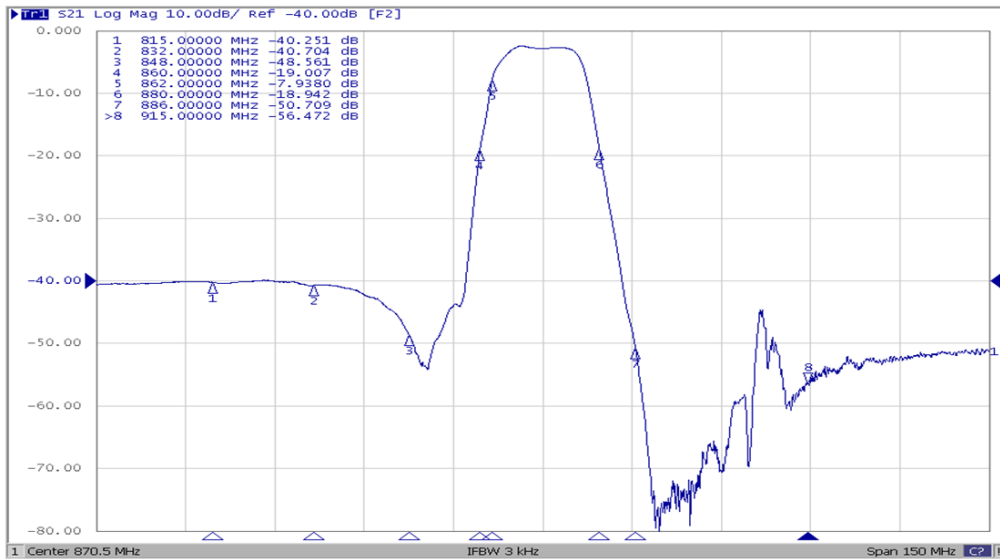
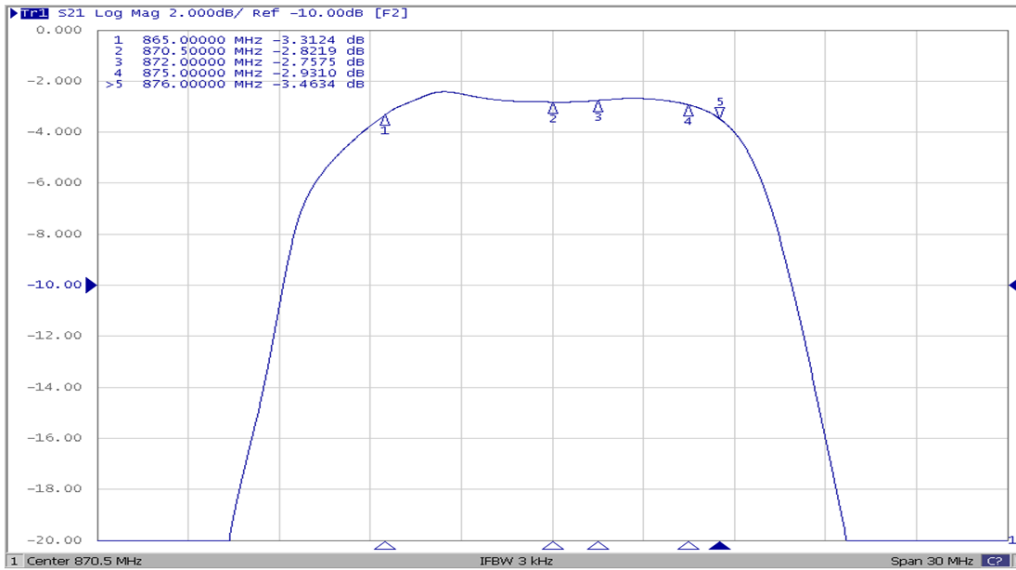

Reflection Functions: S11

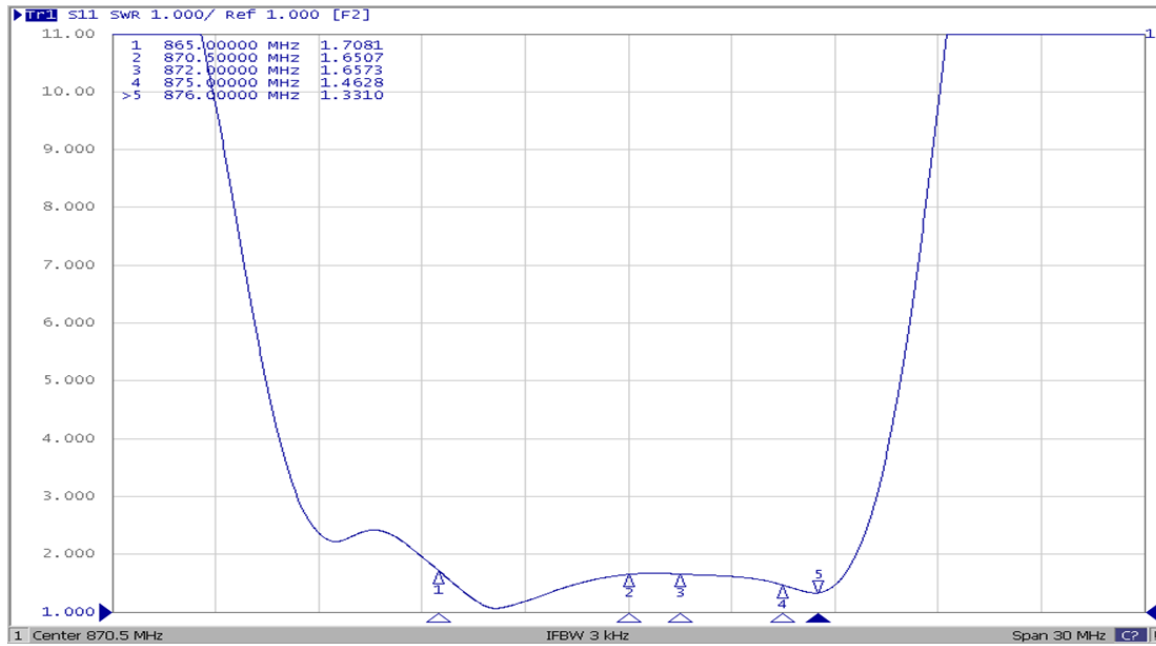

S22

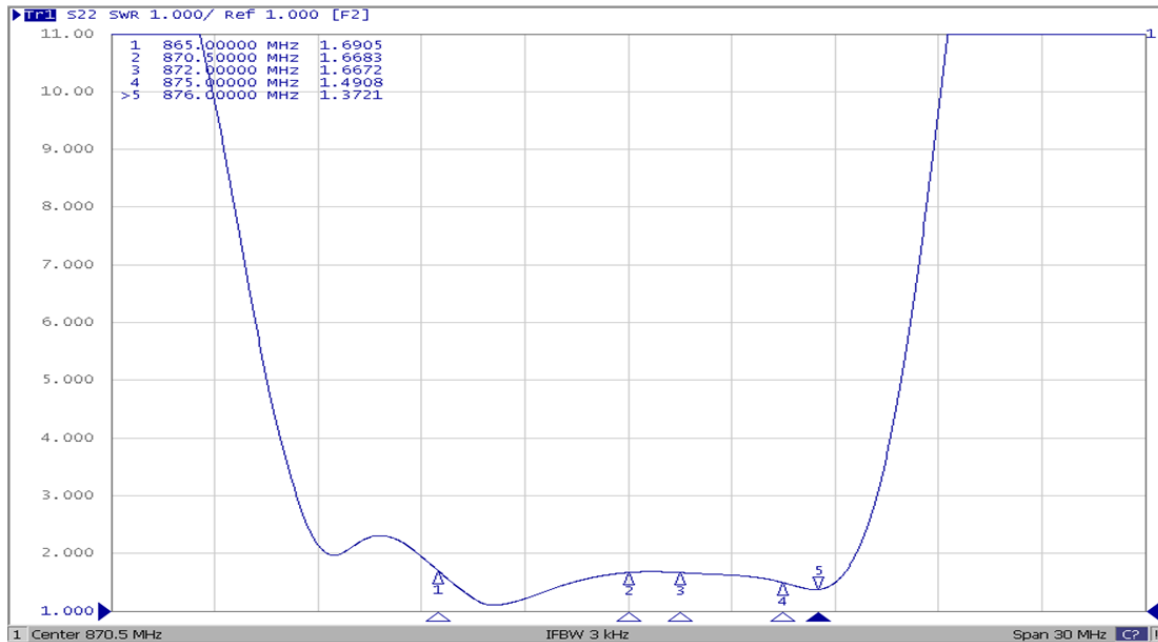

SM3030-6 Ceramic 6-Terminal Surface-Mount Case 3.0 X 3.0 mm Nominal Footprint

Case and PCB Footprint Dimensions

Dimension	mm			Inches		
	Min	Nom	Max	Min	Nom	Max
A	2.87	3.00	3.13	0.113	0.118	0.123
B	2.87	3.00	3.13	0.113	0.118	0.123
C	1.12	1.25	1.38	0.044	0.049	0.054
D	0.77	0.90	1.03	0.030	0.035	0.040
E	2.67	2.80	2.93	0.105	0.110	0.115
F	1.47	1.60	1.73	0.058	0.063	0.068
G	0.72	0.85	0.98	0.028	0.033	0.038
H	1.37	1.50	1.63	0.054	0.059	0.064
I	0.47	0.60	0.73	0.019	0.024	0.029
J	1.17	1.30	1.43	0.046	0.051	0.056
K	-	3.20	-	-	0.126	-
L	-	1.70	-	-	0.067	-
M	-	1.05	-	-	0.041	-
N	-	0.81	-	-	0.032	-
O	-	0.38	-	-	0.015	-
P	0.15	0.30	0.45	0.005	0.011	0.017
Q	0.07	0.20	0.36	0.002	0.007	0.014
R	0.62	0.7	0.78	0.024	0.027	0.030

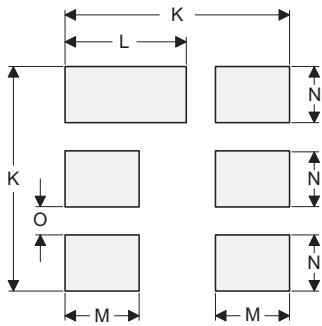
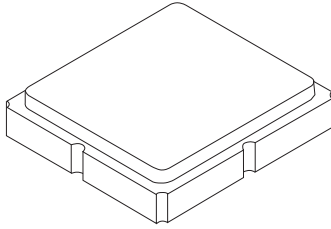

PCB Footprint Top View

Case Materials

Materials	
Solder Pad Plating	0.3 to 1.0 μ m Gold over 1.27 to 8.89 μ m Nickel
Lid Plating	2.0 to 3.0 μ m Nickel
Body	Al ₂ O ₃ Ceramic

Electrical Connections

Connection	Terminals
Input	2
Output	5
Case Ground	All others

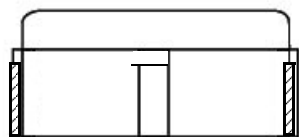
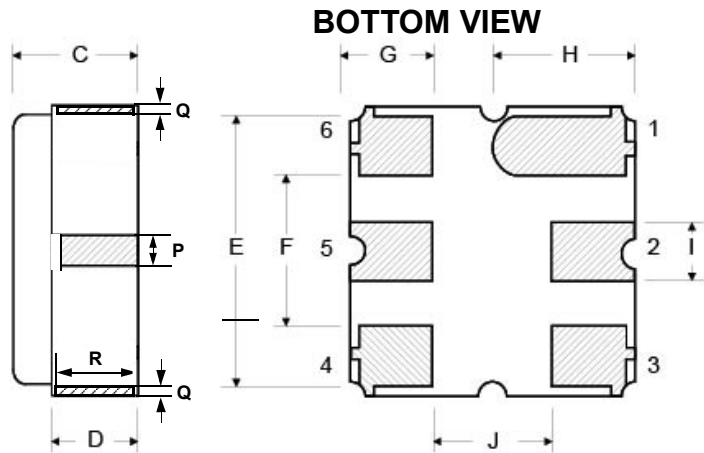
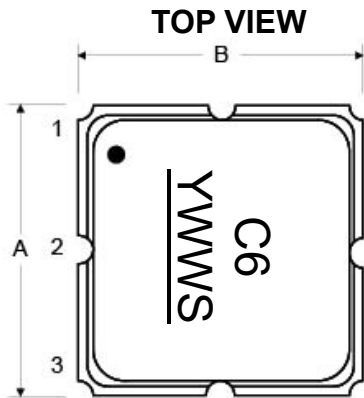

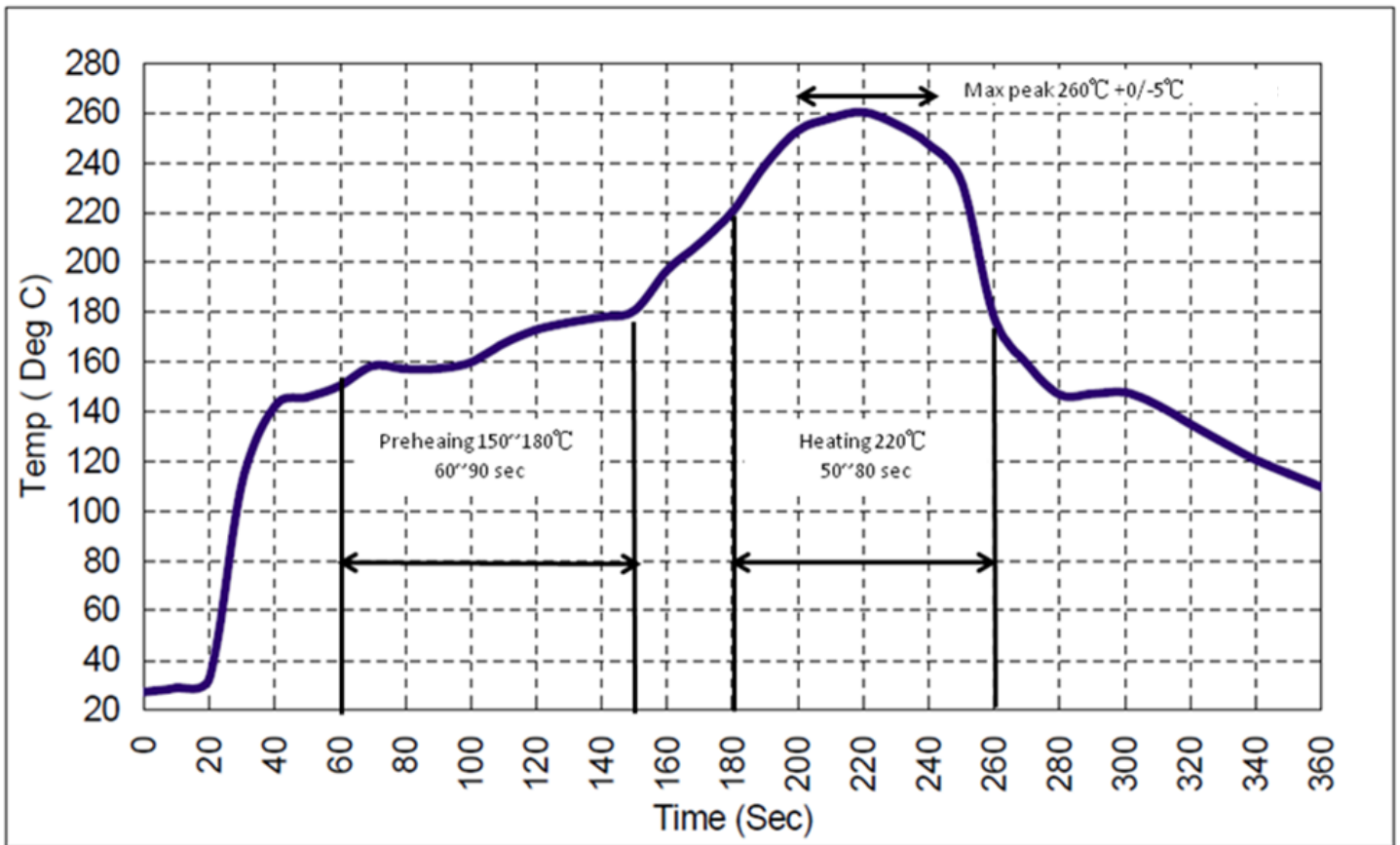

Recommended Reflow Profile

1. Preheating shall be fixed at 150~180°C for 60~90 seconds.
2. Ascending time to preheating temperature 150°C shall be 30 seconds min.
3. Heating shall be fixed at 220°C for 50~80 seconds and at 260°C+0/-5°C peak (10 seconds).
4. Time: 5 times maximum.



Looking for pricing, stock, or lifecycle information?

Click below to explore more details on WIN SOURCE:

-  [View SF2480E on WIN SOURCE](#)
-  [RF Monolithics, Inc Information](#)

Optimize Your Supply Chain with WIN SOURCE Solutions

-  Global Sourcing Solution
-  Obsolete Management
-  Cost Control Management
-  Shortage Management
-  Alternative Solution
-  Excess Inventory Management