



**THE DATASHEET OF  
SF2391E**



- Low-loss 897.5 MHz SAW Filter
- Designed for 50 ohm Source/Load
- Complies with Directive 2002/95/EC (RoHS)
- Moisture Sensitivity Level: 1
- AEC-Q200 Qualified

#### Absolute Maximum Ratings

Rating	Value	Units
Input Power Level	+20	dBm
Input Power Level (Duration 24h, 55°C)	+22	dBm
DC Voltage on any Non-ground Terminal	3	V
Operable Temperature Range	-30 to +105	°C
Specification Temperature Range	-30 to +105	°C
Storage Temperature Range in Tape and Reel	-30 to +85	°C

**SF2391E**

**897.5 MHz  
SAW Filter**

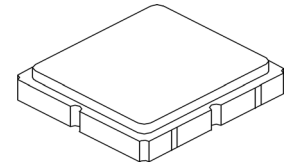

**SM3030-6**

#### Electrical Characteristics

Characteristic	Sym	Notes	Min	Typ	Max	Units
Center Frequency	$f_c$			897.5		MHz
Insertion Loss, 880 to 915 MHz	IL			2.5	3.5	dB
Amplitude Ripple (p-p), 880 to 915 MHz				1.3	2.0	dBp-p
Attenuation (Reference level from 0dB)						dB
10 to 738 MHz			35	43		
738 to 773 MHz			35	46		
773 to 860 MHz			20	32		
925 to 927 MHz		+25°C to +105°C	25	30		
		-30°C to +105°C	16	30		
927 to 930 MHz			25	30		
930 to 960 MHz			25	27		
960 to 1000 MHz			25	33		
1000 to 2035 MHz			25	33		
2035 to 2500 MHz			25	34		
2500 to 3000 MHz			25	33		
3000 to 3500 MHz			20	33		
Temperature Coefficient of Frequency				-36		ppm/k
Case Style	SMD 3.0 x 3.0 mm Nominal Footprint					
Lid Symbolization (Y=year, WW=week, S=shift) dot=pin 1 indicator	6Y, <u>YWWS</u>					

 **CAUTION: Electrostatic Sensitive Device. Observe precautions for handling.**

**NOTES:**

1. The design, manufacturing process, and specifications of this device are subject to change.
2. US or International patents may apply.
3. RoHS compliant from the first date of manufacture.

## Measurement Circuit:

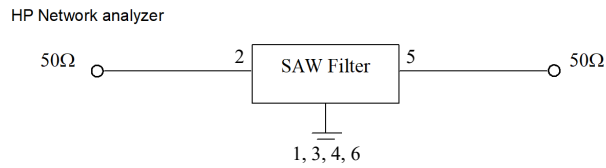

#2: Input  
 #5: Output  
 #1,3,4,6: Ground

## Frequency Characteristics:

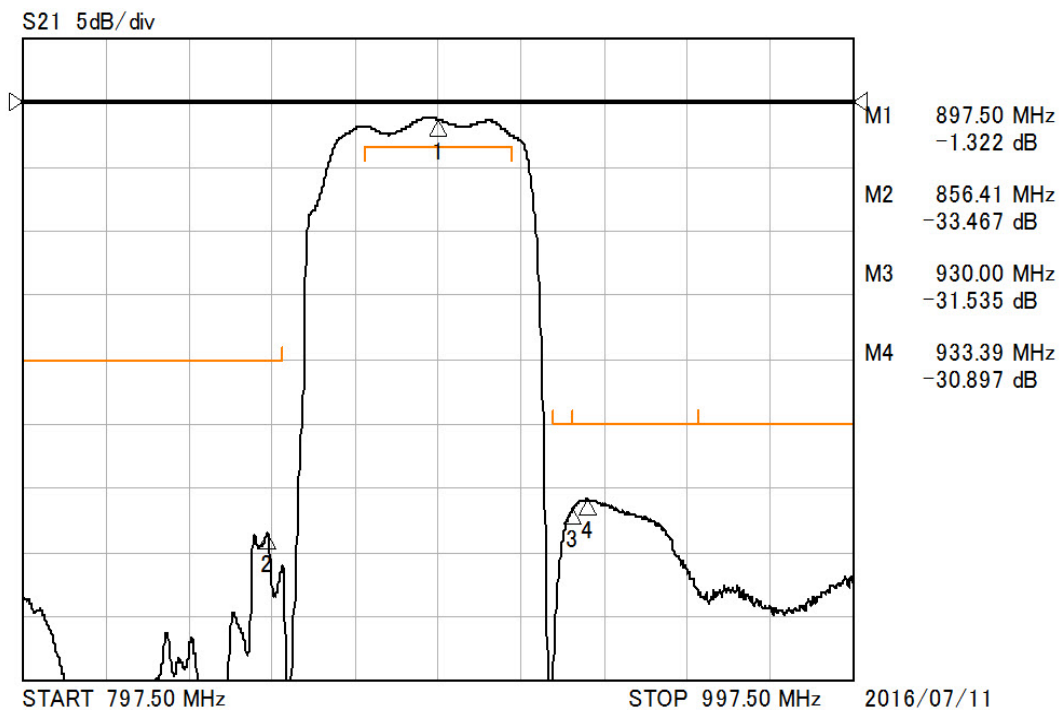
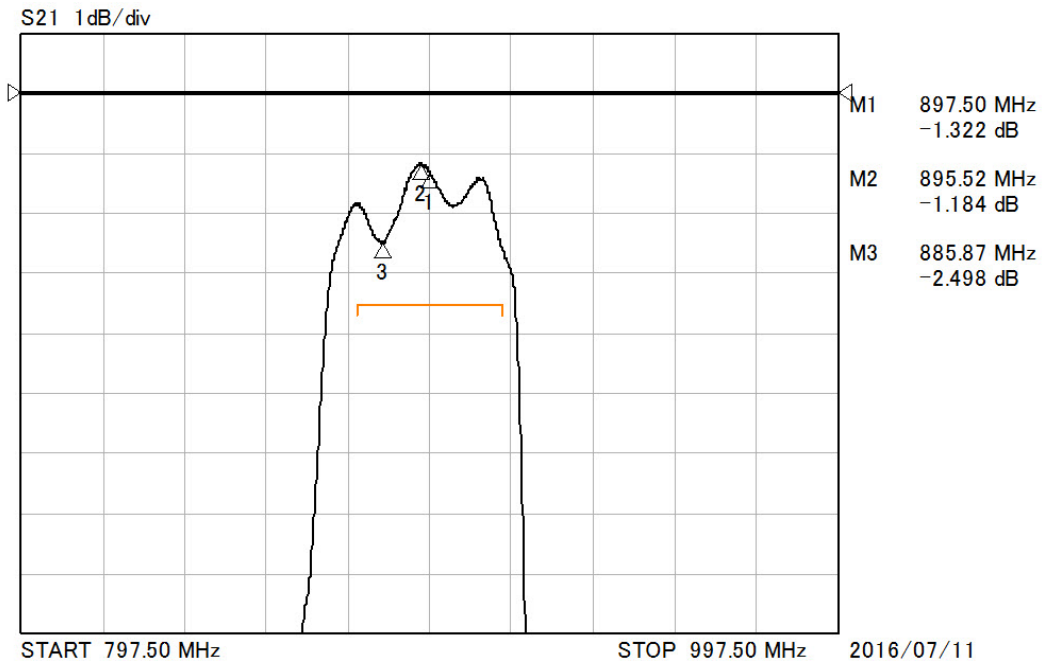

# Frequency Characteristics:

S21 10dB/div

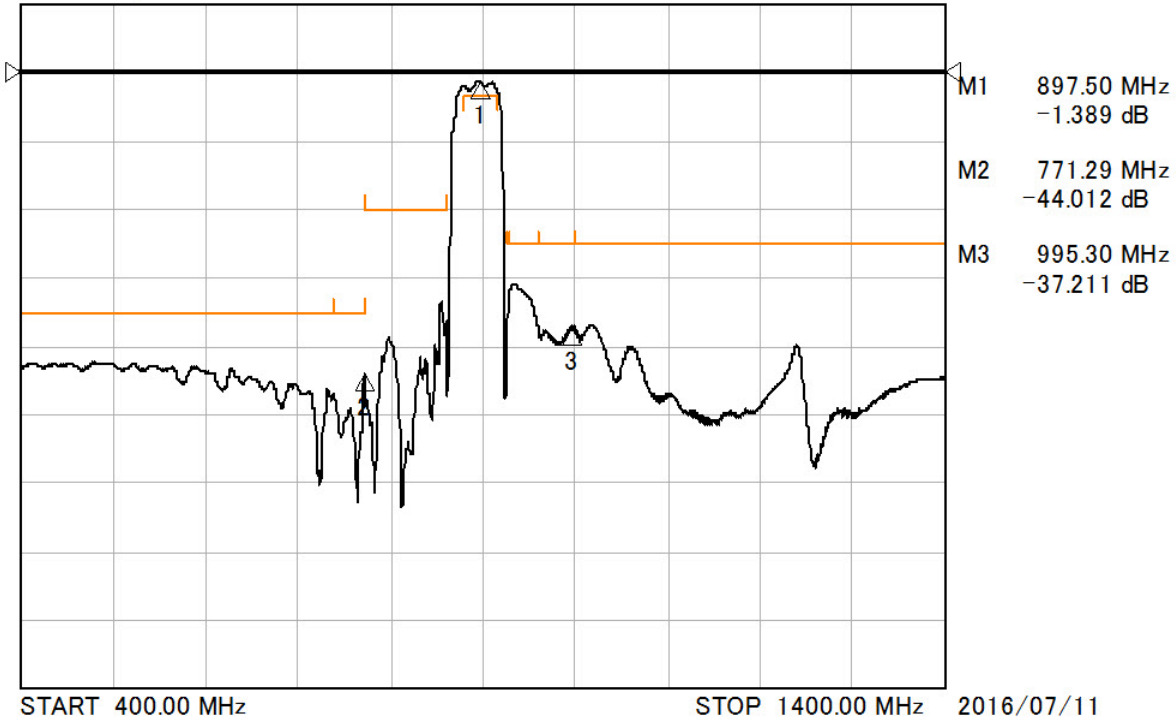

S21 10dB/div

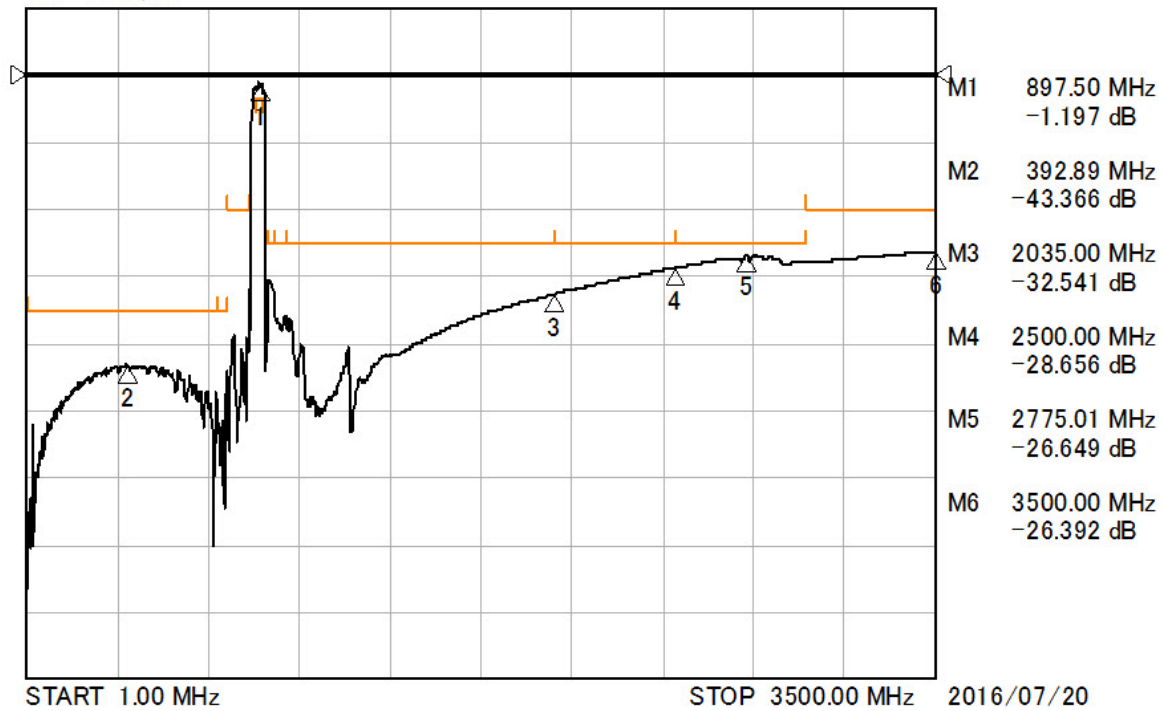

# SM3030-6 Ceramic 6-Terminal Surface-Mount Case 3.0 X 3.0 mm Nominal Footprint

## Case and PCB Footprint Dimensions

Dimension	mm			Inches		
	Min	Nom	Max	Min	Nom	Max
A	2.87	3.00	3.13	0.113	0.118	0.123
B	2.87	3.00	3.13	0.113	0.118	0.123
C	1.12	1.25	1.38	0.044	0.049	0.054
D	0.77	0.90	1.03	0.030	0.035	0.040
E	2.67	2.80	2.93	0.105	0.110	0.115
F	1.47	1.60	1.73	0.058	0.063	0.068
G	0.72	0.85	0.98	0.028	0.033	0.038
H	1.37	1.50	1.63	0.054	0.059	0.064
I	0.47	0.60	0.73	0.019	0.024	0.029
J	1.17	1.30	1.43	0.046	0.051	0.056
K		3.20			0.126	
L		1.70			0.067	
M		1.05			0.041	
N		0.81			0.032	
O		0.38			0.015	

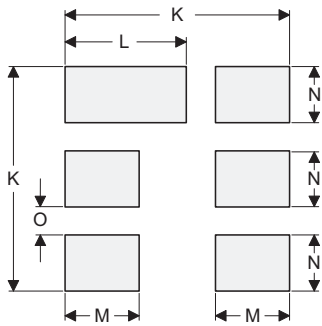
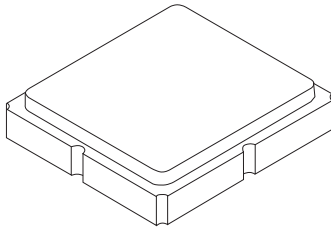

**PCB Footprint Top View**

## Case Materials

Materials	
Solder Pad Plating	0.3 to 1.0 $\mu\text{m}$ Gold over 1.27 to 8.89 $\mu\text{m}$ Nickel
Lid Plating	2.0 to 3.0 $\mu\text{m}$ Nickel
Body	$\text{Al}_2\text{O}_3$ Ceramic

## Electrical Connections

Connection	Terminals
Input	2
Output	5
Case Ground	All others

**TOP VIEW**

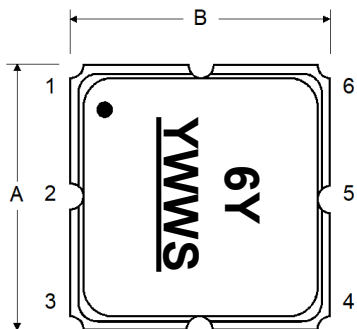

**BOTTOM VIEW**

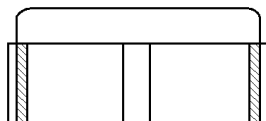
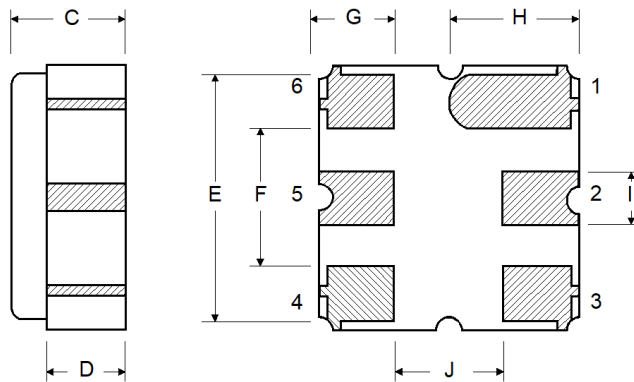



## Recommended Reflow Profile

1. Preheating shall be fixed at 150~180°C for 60~90 seconds.
2. Ascending time to preheating temperature 150°C shall be 30 seconds min.
3. Heating shall be fixed at 220°C for 50~80 seconds and at 260°C +0/-5°C peak (10 seconds).
4. Time: 5 times maximum.

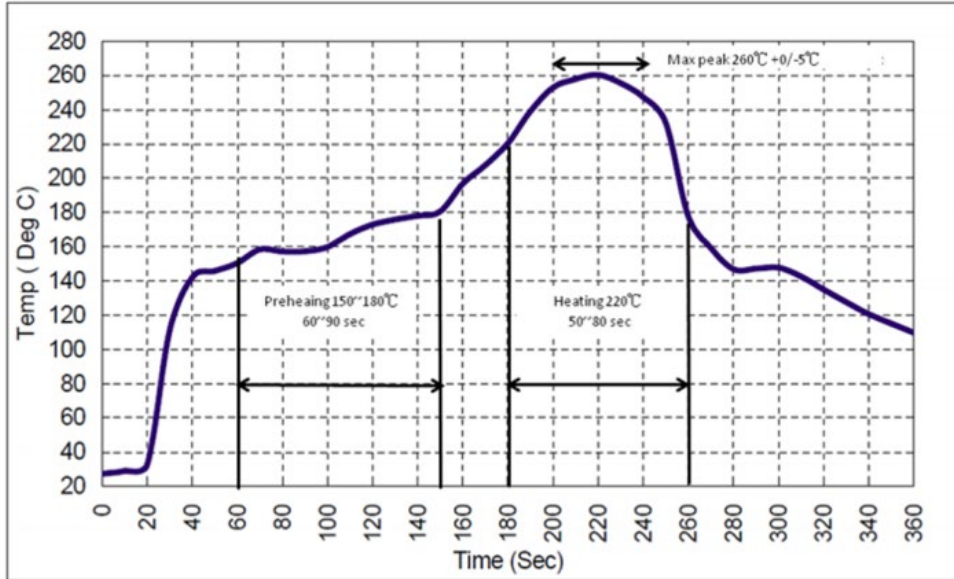

## Looking for pricing, stock, or lifecycle information?

Click below to explore more details on WIN SOURCE:

 [View SF2391E on WIN SOURCE](#)

 [RF Monolithics, Inc Information](#)

## Optimize Your Supply Chain with WIN SOURCE Solutions

-  Global Sourcing Solution
-  Obsolete Management
-  Cost Control Management
-  Shortage Management
-  Alternative Solution
-  Excess Inventory Management