



**THE DATASHEET OF  
SF1184B-1**



- **RF Filter for GSM900**
- **No Matching Circuit Required**
- **3.0 x 3.0 x 1.3 mm Package**
- **Complies with Directive 2002/95/EC (RoHS)**
- **Moisture Sensitivity Level: 1**

**SF1184B-1**

**947.5 MHz  
SAW Filter**

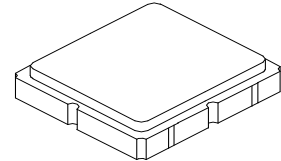

**SM3030-6**

**Absolute Maximum Ratings**

Rating	Value	Units
Maximum Input Power	+15	dBm
DC voltage between Terminals	-5 to +5	VDC
Operable Temperature Range	-45 to +125	°C
Specification Temperature Range	-30 to +85	°C

**Electrical Characteristics**

Characteristic	Sym	Notes	Min	Typ	Max	Units				
Nominal Operating Frequency	$f_c$			947.5		MHz				
Passband	Insertion Loss (935~960 MHz)	IL		2.7	3.5	dB				
							Amplitude Ripple (935~960 MHz)	0.6	1.4	dB
Attenuation	D.C.~871 MHz		50	62.1		dB				
							890~915 MHz	30	43.9	dB
							980~1025 MHz	25	28.6	dB
							1025~2000 MHz	45	54.1	dB
							2000~3000 MHz	20	26.8	dB
VSWR (935~960 MHz)				1.6	2.3	dB				
Temperature Coefficient				-36		ppm/°C				
Impedance at $f_c$ ; Input $Z_{IN}$				50		$\Omega$				
Output $Z_{OUT}$				50		$\Omega$				

Case Style	SM3030-6 3 x 3 mm Nominal Footprint
Lid Symbolization (Y=year, WW=week, S=Shift)	459, <u>YWWS</u>

**Electrical Connections**

Connection	Terminals
Input	2
Output	5
Ground	All others



**CAUTION: Electrostatic Sensitive Device. Observe precautions for handling.**

**NOTES:**

1. The design, manufacturing process, and specifications of this device are subject to change.
2. US or International patents may apply.
3. RoHS compliant from the first date of manufacture.

**FREQUENCY CHARACTERISTICS:**

**1. wideband response:**

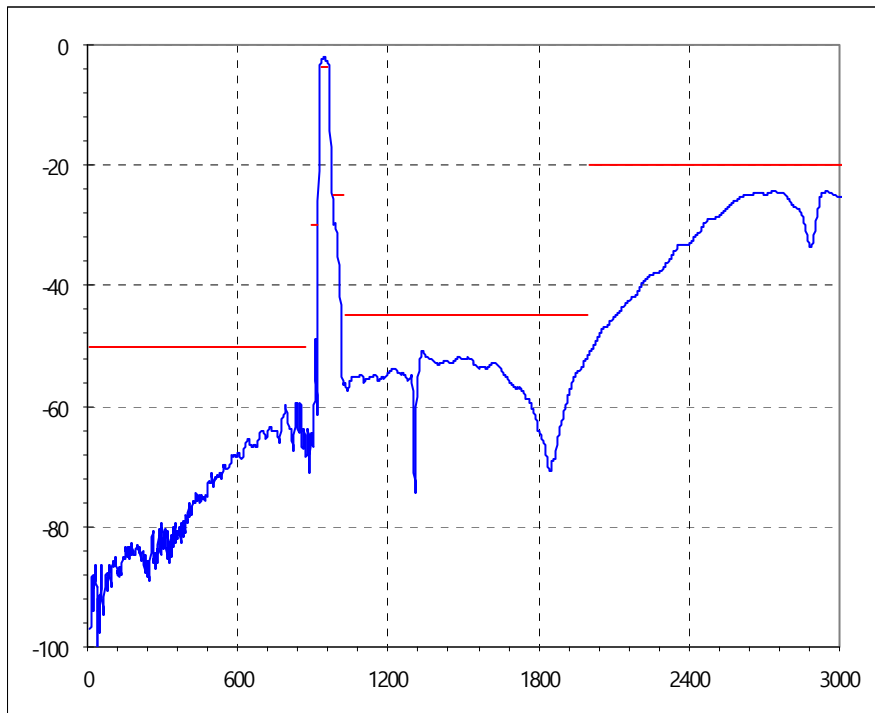
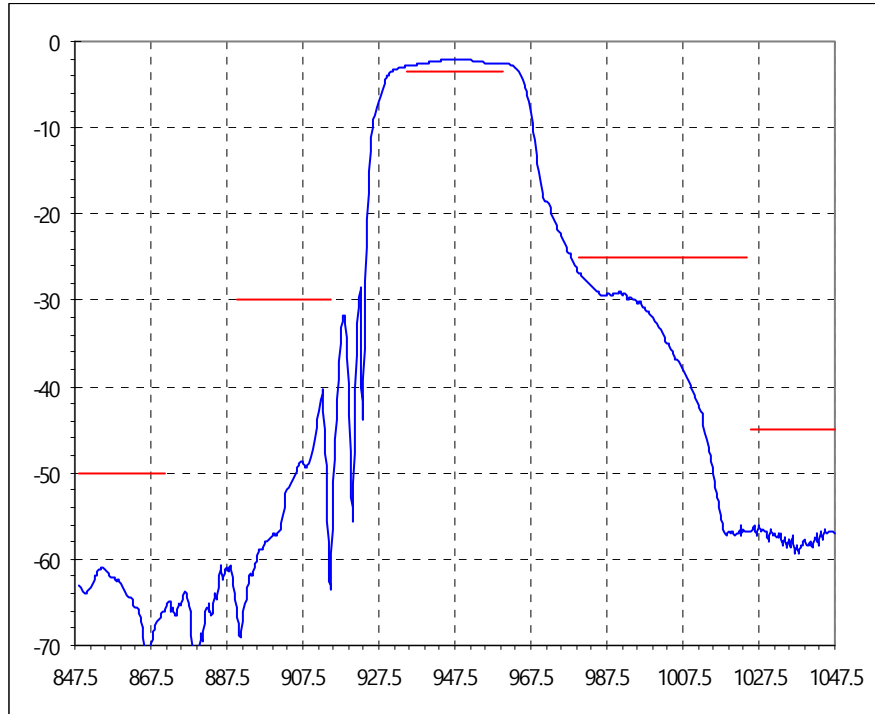

1. passband response:

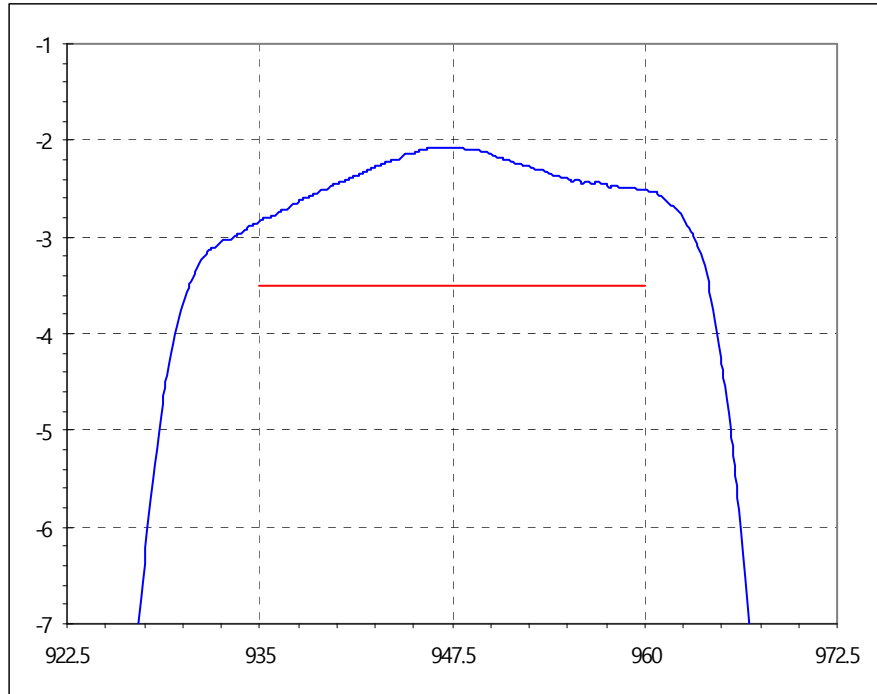

2. VSRW:

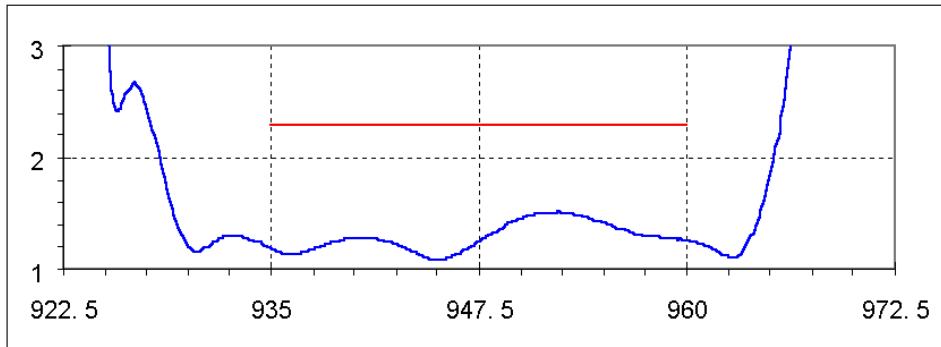

S22

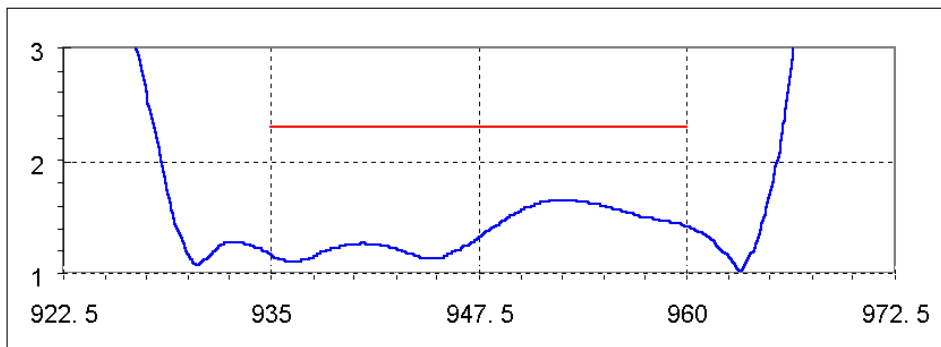

3. Smith chart of S11:

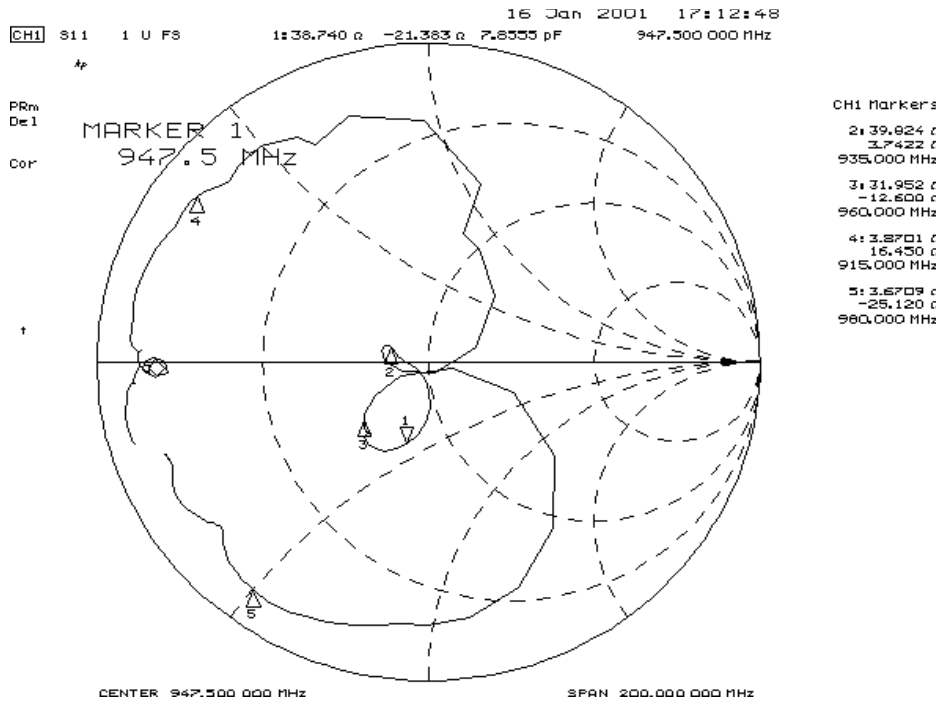

4. Smith chart of S22:

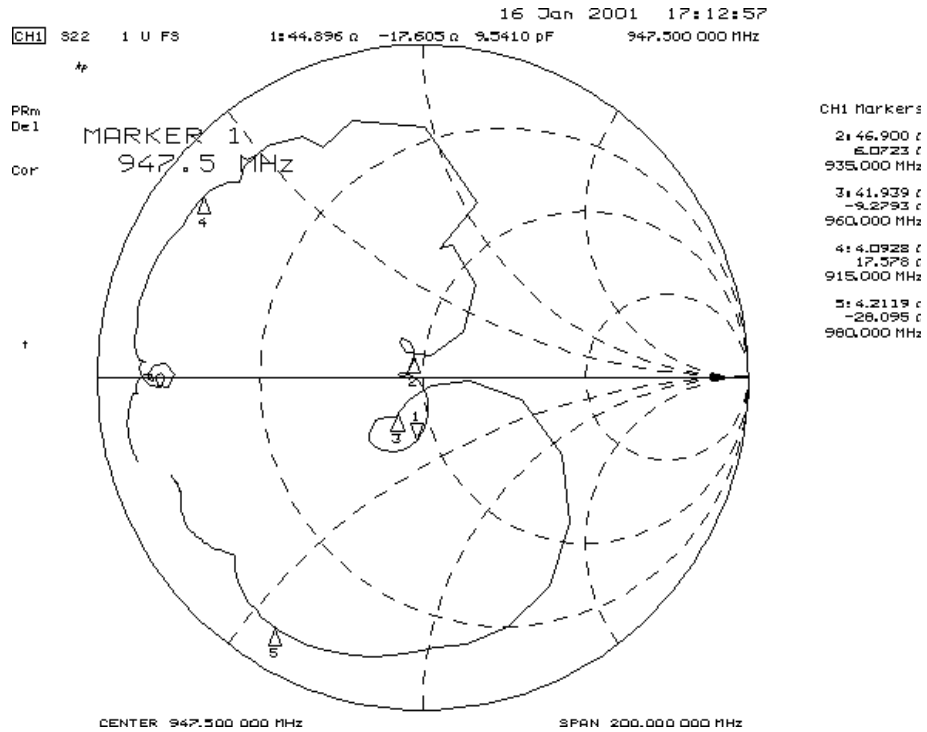

# Tape and Reel Specifications

Tape and Reel Standard per ANSI/EIA-481

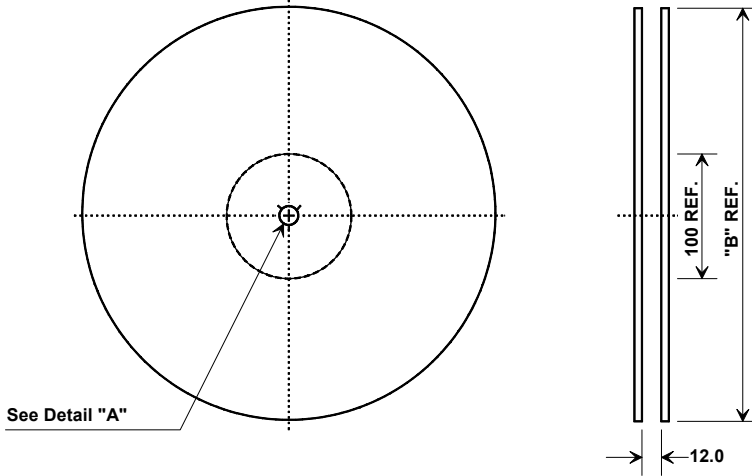

"B" Nominal Size		Quantity Per Reel
Inches	millimeters	
7	178	500
13	330	3000

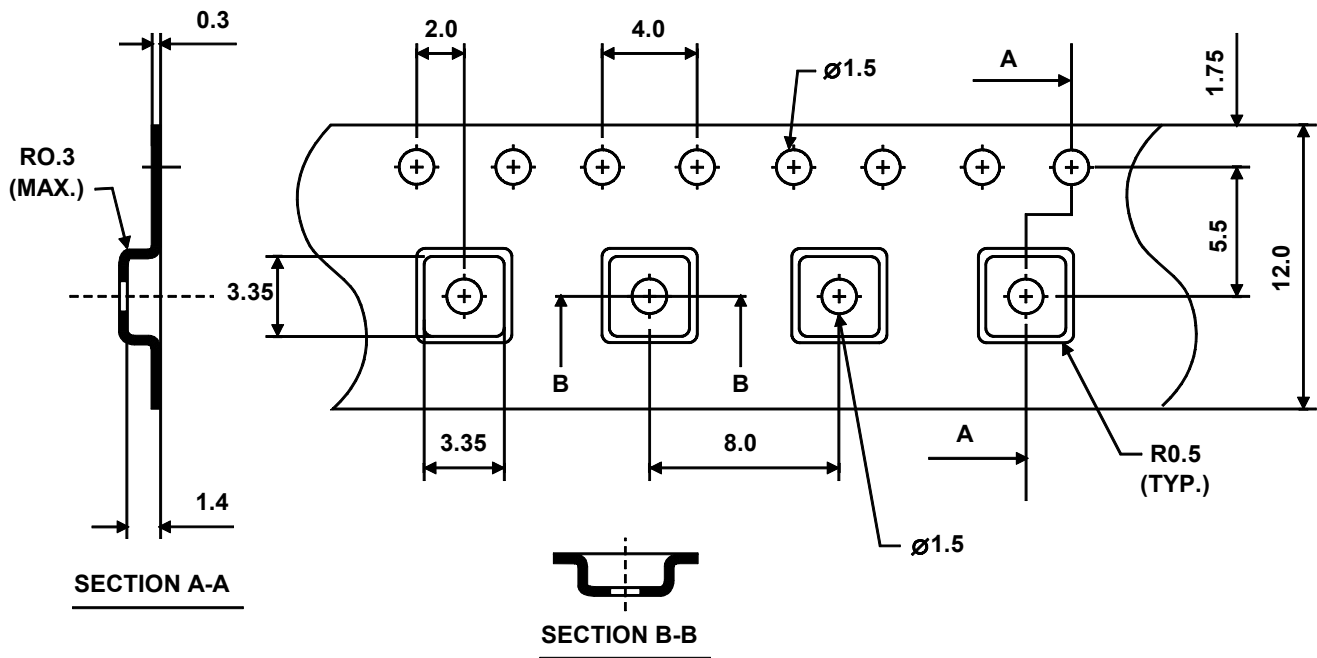
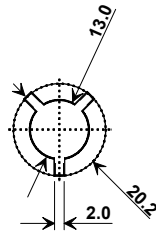

# SM3030-6 Case

## 6-Terminal Ceramic Surface-Mount Case 3.0 X 3.0 mm Nominal Footprint

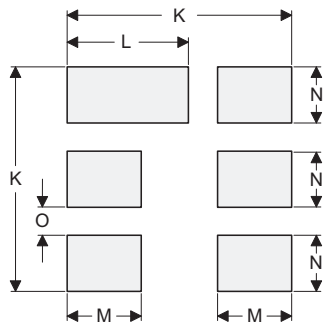
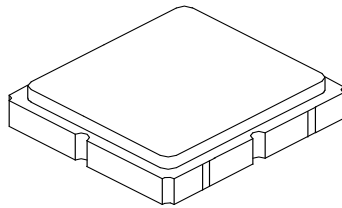

PCB FOOTPRINT

Case and PCB Footprint Dimensions

Dimension	mm			Inches		
	Min	Nom	Max	Min	Nom	Max
A	2.87	3.00	3.13	0.113	0.118	0.123
B	2.87	3.00	3.13	0.113	0.118	0.123
C	1.12	1.25	1.38	0.044	0.049	0.054
D	0.77	0.90	1.03	0.030	0.035	0.040
E	2.67	2.80	2.93	0.105	0.110	0.115
F	1.47	1.60	1.73	0.058	0.063	0.068
G	0.72	0.85	0.98	0.028	0.033	0.038
H	1.37	1.50	1.63	0.054	0.059	0.064
I	0.47	0.60	0.73	0.019	0.024	0.029
J	1.17	1.30	1.43	0.046	0.051	0.056
K		3.20			0.126	
L		1.70			0.067	
M		1.05			0.041	
N		0.81			0.032	
O		0.38			0.015	

Case Materials

Solder Pad Plating	0.3 to 1.0 $\mu\text{m}$ Gold over 1.27 to 8.89 $\mu\text{m}$ Nickel
Lid Plating	2.0 to 3.0 $\mu\text{m}$ Nickel
Body	$\text{Al}_2\text{O}_3$ Ceramic

TOP VIEW

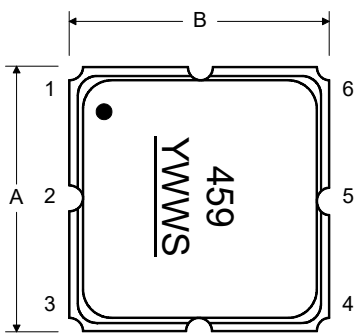

BOTTOM VIEW

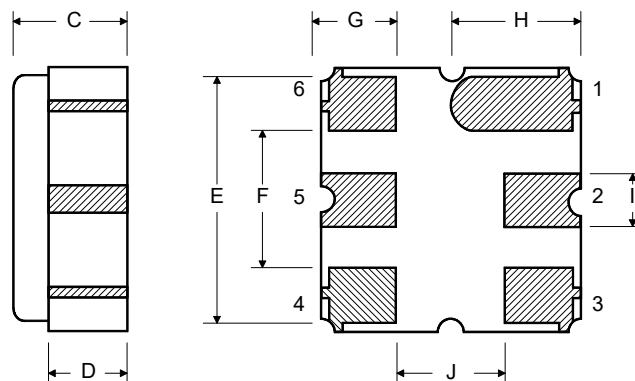

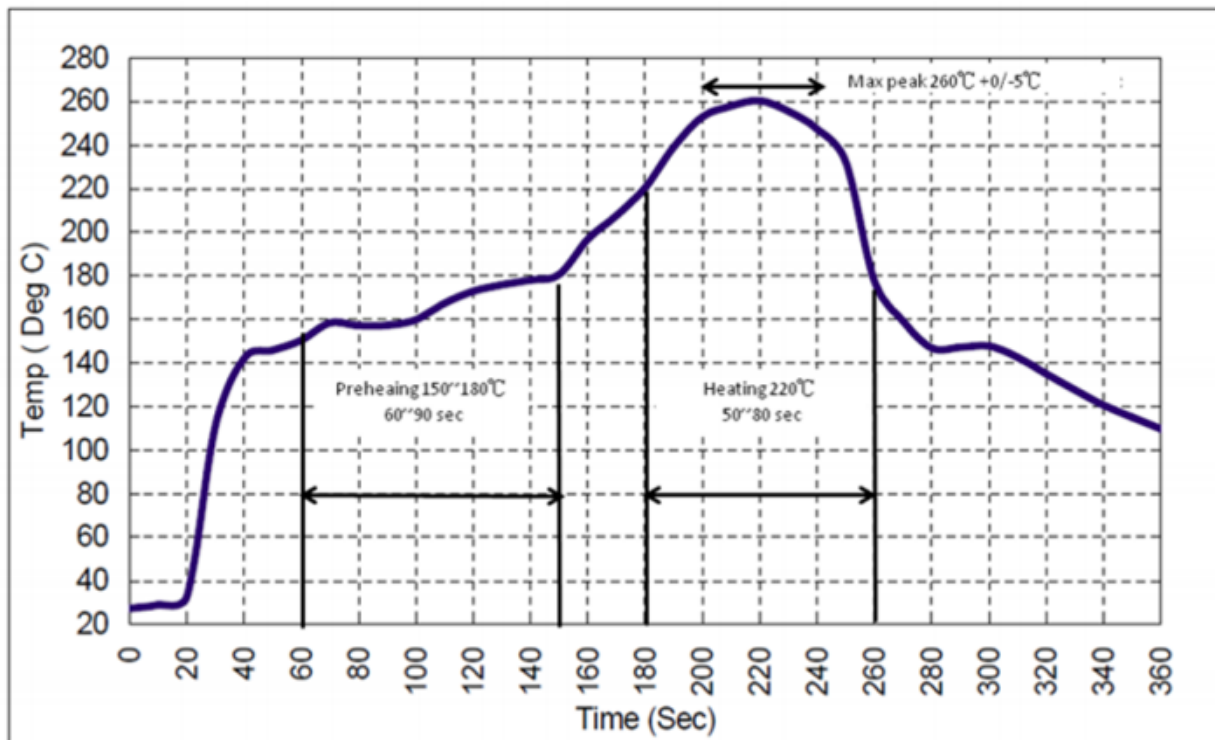

## Recommended Reflow Profile

1. Preheating shall be fixed at 150~180°C for 60~90 seconds.
2. Ascending time to preheating temperature 150°C shall be 30 seconds min.
3. Heating shall be fixed at 220°C for 50~80 seconds and at 260°C+0/-5°C peak (10 seconds).
4. Time: 5 times maximum.



## Looking for pricing, stock, or lifecycle information?

Click below to explore more details on WIN SOURCE:

-  [View SF1184B-1 on WIN SOURCE](#)
-  [RF Monolithics, Inc Information](#)

## Optimize Your Supply Chain with WIN SOURCE Solutions

-  Global Sourcing Solution
-  Obsolete Management
-  Cost Control Management
-  Shortage Management
-  Alternative Solution
-  Excess Inventory Management