



**THE DATASHEET OF
SDR0602-561KL**





Features

- Available in E12 series
- Unit height of 2.2 mm
- Current up to 1.5 A
- High Q level
- RoHS compliant*

The SDR0602 Series is obsolete and not recommended for new designs.

SDR0602 Series - SMD High Power Inductor

Electrical Specifications

Bourns Part No.	Inductance 1kHz		Q Ref.	Test Frequency (MHz)	SRF Min. (MHz)	RDC Max. (Ω)	I rms Max. (A)	I sat Typ. (A)
	(μH)	Tol. %						
SDR0602-2R7ML	2.7	± 20	20	7.96	40	0.12	1.50	2.10
SDR0602-3R9ML	3.9	± 20	20	7.96	40	0.13	1.40	1.90
SDR0602-4R7ML	4.7	± 20	20	7.96	35	0.15	1.30	1.80
SDR0602-5R6ML	5.6	± 20	18	7.96	30	0.17	1.20	1.60
SDR0602-6R8ML	6.8	± 20	18	7.96	28	0.18	1.15	1.55
SDR0602-8R2ML	8.2	± 20	15	7.96	27	0.20	1.10	1.43
SDR0602-100ML	10	± 20	50	2.52	25	0.24	1.00	1.32
SDR0602-120ML	12	± 20	45	2.52	21	0.26	0.90	1.17
SDR0602-150ML	15	± 20	45	2.52	20	0.28	0.80	1.10
SDR0602-180ML	18	± 20	45	2.52	18	0.30	0.75	1.07
SDR0602-220ML	22	± 20	45	2.52	16	0.40	0.70	0.90
SDR0602-270ML	27	± 20	40	2.52	15	0.45	0.65	0.83
SDR0602-330KL	33	± 10	35	2.52	12	0.50	0.60	0.73
SDR0602-390KL	39	± 10	32	2.52	12	0.65	0.55	0.68
SDR0602-470KL	47	± 10	30	2.52	11	0.68	0.50	0.62
SDR0602-560KL	56	± 10	30	2.52	10	0.78	0.45	0.57
SDR0602-680KL	68	± 10	27	2.52	9	0.85	0.40	0.52
SDR0602-820KL	82	± 10	27	2.52	8	1.30	0.35	0.46
SDR0602-101KL	100	±10	50	0.796	7	1.52	0.32	0.42
SDR0602-121KL	120	± 10	50	0.796	6	1.65	0.30	0.38
SDR0602-151KL	150	± 10	60	0.796	6	2.00	0.26	0.24
SDR0602-181KL	180	± 10	55	0.796	5	2.30	0.23	0.32
SDR0602-221KL	220	± 10	55	0.796	5	2.50	0.20	0.29
SDR0602-271KL	270	± 10	55	0.796	4	2.85	0.18	0.26
SDR0602-331KL	330	± 10	55	0.796	4	3.80	0.16	0.22
SDR0602-391KL	390	± 10	55	0.796	3	4.20	0.15	0.20
SDR0602-471KL	470	± 10	55	0.796	3	5.00	0.14	0.18
SDR0602-561KL	560	± 10	55	0.796	3	6.20	0.12	0.14

General Specifications

Test Voltage.....1 Volt
 Reflow Soldering.....260 °C, 50 sec max.
 Operating Temperature ..-40 °C to +125 °C
 (Temperature rise included)
 Storage Temperature...-40 °C to +125 °C
 Packaging.....800 pcs. per reel
 Resistance to Soldering Heat
260 °C for 5 sec.

Materials

Core MaterialFerrite DQ
 WireEnameled Copper
 Terminal.....Ag/Ni/Sn
 Rated Current...Ind. drop 10 % typ. at Isat
 Temperature Rise...40 °C max at rated Irms

Product Dimensions

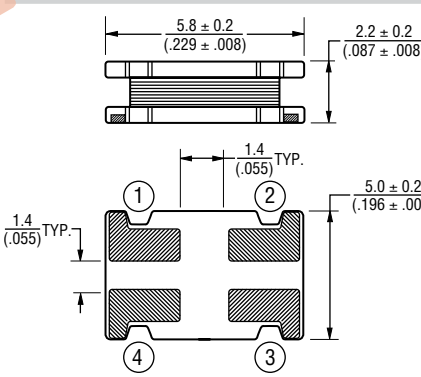

Recommended Layout

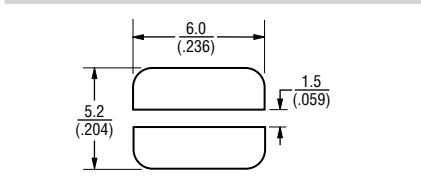

Typical Part Marking

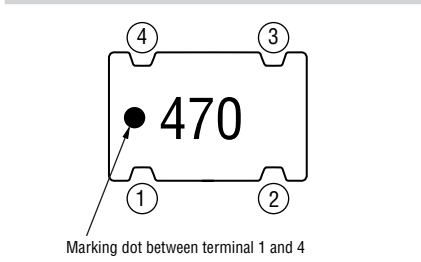

Electrical Schematic

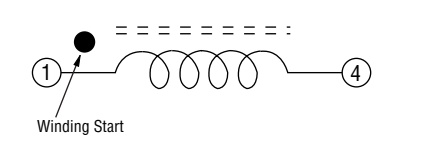

*RoHS Directive 2002/95/EC Jan 27, 2003 including Annex. Specifications are subject to change without notice. Customers should verify actual device performance in their specific applications.

DIMENSIONS: $\frac{\text{MM}}{\text{(INCHES)}}$

Applications

- Input/output of DC/DC converters
- Power supplies for:
 - Portable communication equipment
 - Camcorders
 - LCD TVs
 - Car radios

SDR0602 Series - SMD Power Inductors

BOURNS®

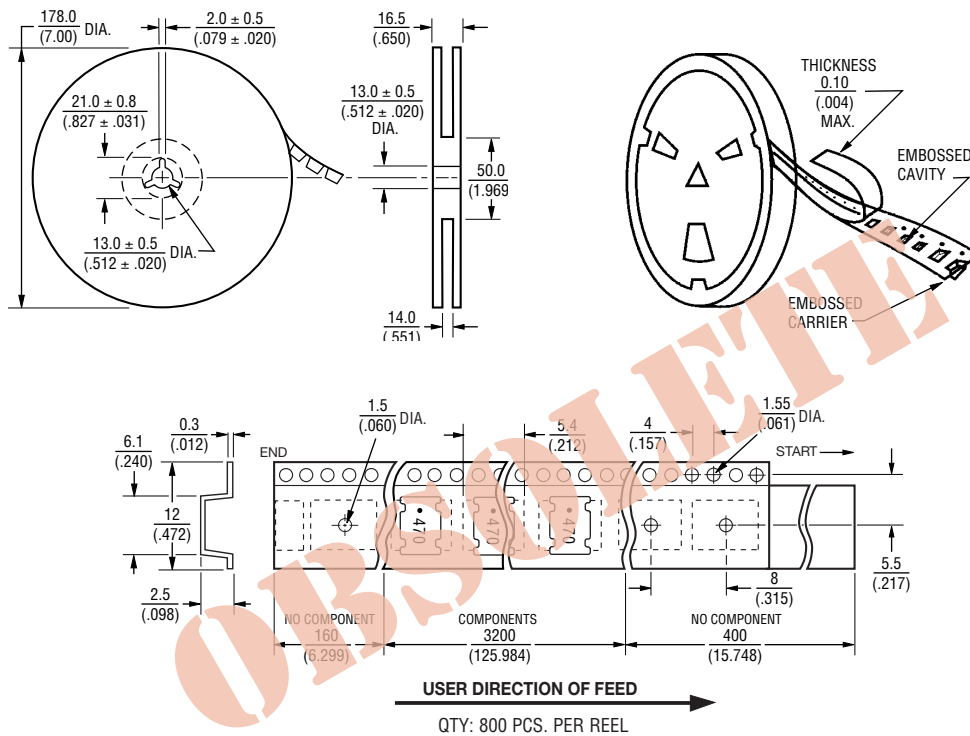

Packaging Specifications



DIMENSIONS: $\frac{\text{MM}}{\text{(INCHES)}}$

Looking for pricing, stock, or lifecycle information?

Click below to explore more details on WIN SOURCE:

-  [View SDR0602-561KL on WIN SOURCE](#)
-  [Bourns Inc. Information](#)

Optimize Your Supply Chain with WIN SOURCE Solutions

-  Global Sourcing Solution
-  Obsolete Management
-  Cost Control Management
-  Shortage Management
-  Alternative Solution
-  Excess Inventory Management