

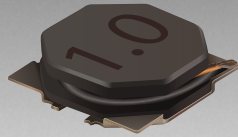

**THE DATASHEET OF  
SRN4012-3R3M**



\*RoHS COMPLIANT



**BOURNS®**

**Features**

- Semi-shielded construction
- Low profile: 1.2 mm
- Inductance range: 0.47 to 22  $\mu$ H
- Rated current up to 3.2 A
- RoHS compliant\* and halogen free\*\*

 This series is currently available, but not recommended for new designs. The **Model SRN4012T Series** is the recommended alternative.

**SRN4012 Series - Semi-shielded Power Inductors**

**Electrical Specifications @ 25 °C**

Bourns Part No.	Inductance @ 100 KHz / 0.1 V		DCR ( $\Omega$ ) Max.	I <sub>rms</sub> (A)	I <sub>sat</sub> (A)
	L ( $\mu$ H)	Tol. %			
SRN4012-R47M	0.47	20	0.03	3.2	4
SRN4012-1R0M	1.0	20	0.045	2.2	2.8
SRN4012-1R5M	1.5	20	0.06	2	2.2
SRN4012-2R2M	2.2	20	0.072	1.9	1.65
SRN4012-3R3M	3.3	20	0.101	1.7	1.4
SRN4012-4R7M	4.7	20	0.114	1.5	1.2
SRN4012-6R8M	6.8	20	0.15	1.3	0.9
SRN4012-100M	10	20	0.204	1.1	0.8
SRN4012-220M	22	20	0.48	0.62	0.5

**Soldering Profile**

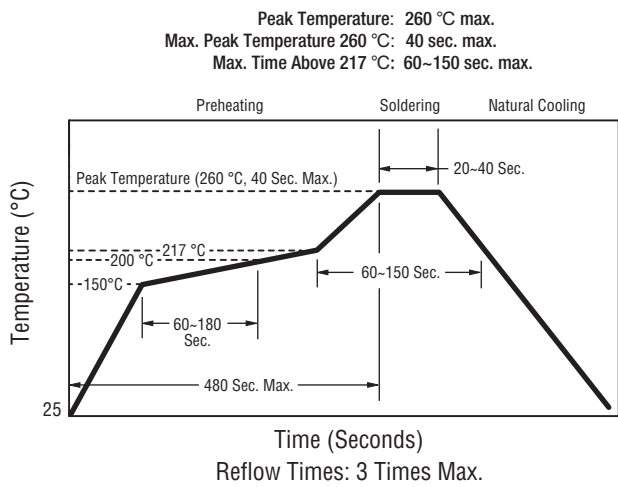

**General Specifications**

Operating Temperature ..... -40 °C to +125 °C  
 (Temperature rise included)  
 Storage Temperature .. -40 °C to +125 °C  
 Resistance to Solder Heat ..... +260 °C for 40 sec.  
 Temperature Rise ..... 40 °C at rated I<sub>rms</sub>  
 Rated Current ..... Inductance drops 30 % at I<sub>sat</sub>

**Materials**

Core ..... Ferrite  
 Wire ..... Enameled copper  
 Terminal Finish ..... Sn  
 Coating ..... Magnetic epoxy resin  
 Packaging ..... 4000 pcs. per 13-inch reel

**Product Dimensions**

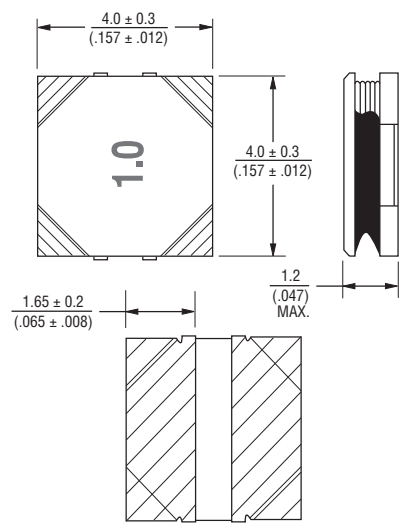

**Electrical Schematic**

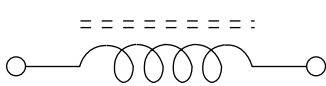

**How to Order**

**SRN4012 - R47M**  
 Model \_\_\_\_\_  
 Value Code (see table) \_\_\_\_\_

**Recommended Layout**

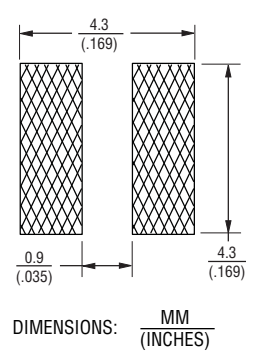

\*RoHS Directive 2002/95/EC Jan. 27, 2003 including annex and RoHS Recast 2011/65/EU June 8, 2011.  
 \*\*Bourns follows the prevailing definition of "halogen free" in the industry. Bourns considers a product to be "halogen free" if (a) the Bromine (Br) content is 900 ppm or less; (b) the Chlorine (Cl) content is 900 ppm or less; and (c) the total Bromine (Br) and Chlorine (Cl) content is 1500 ppm or less.  
 Specifications are subject to change without notice.  
 The device characteristics and parameters in this data sheet can and do vary in different applications and actual device performance may vary over time.  
 Users should verify actual device performance in their specific applications.

## Applications

- DC/DC converters
- Notebook computers
- Digital video cameras
- HDDs
- Cellphones
- Televisions, LCD displays

# SRN4012 Series - Semi-shielded Power Inductors

**BOURNS®**

### L vs. IDC

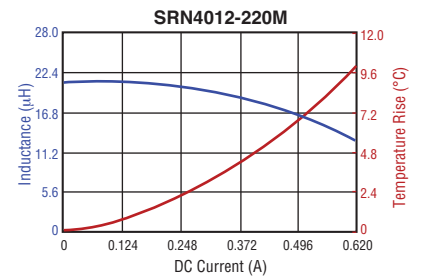
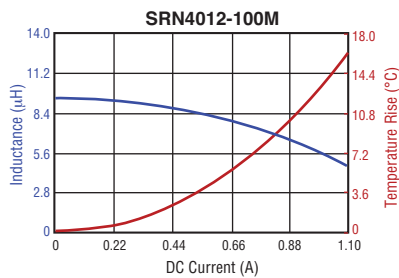
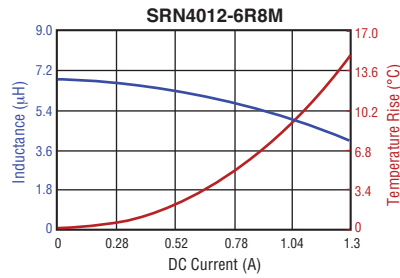
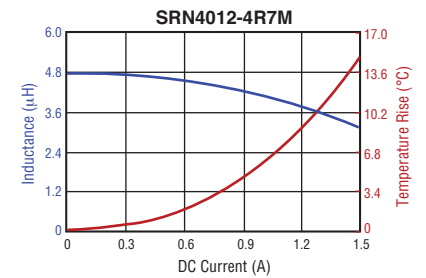
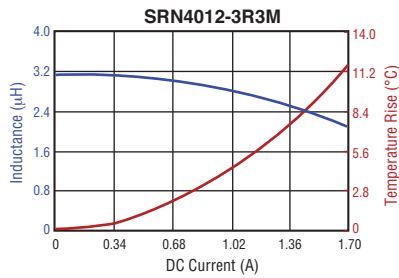
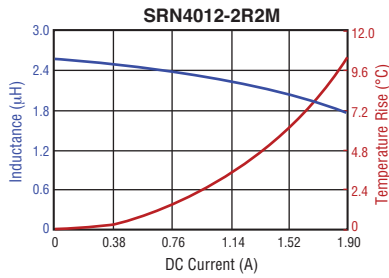
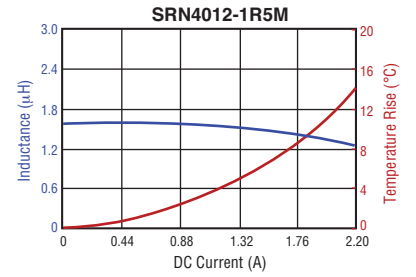
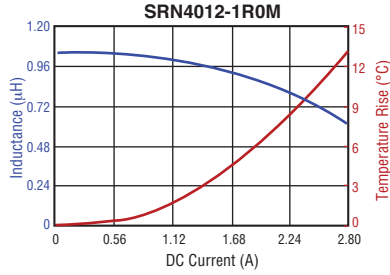
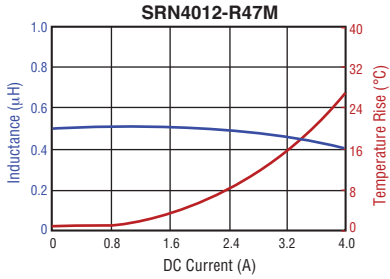

Specifications are subject to change without notice.  
 The device characteristics and parameters in this data sheet can and do vary in different applications and actual device performance may vary over time.  
 Users should verify actual device performance in their specific applications.

# SRN4012 Series - Semi-shielded Power Inductors

**BOURNS®**

## Packaging Specifications

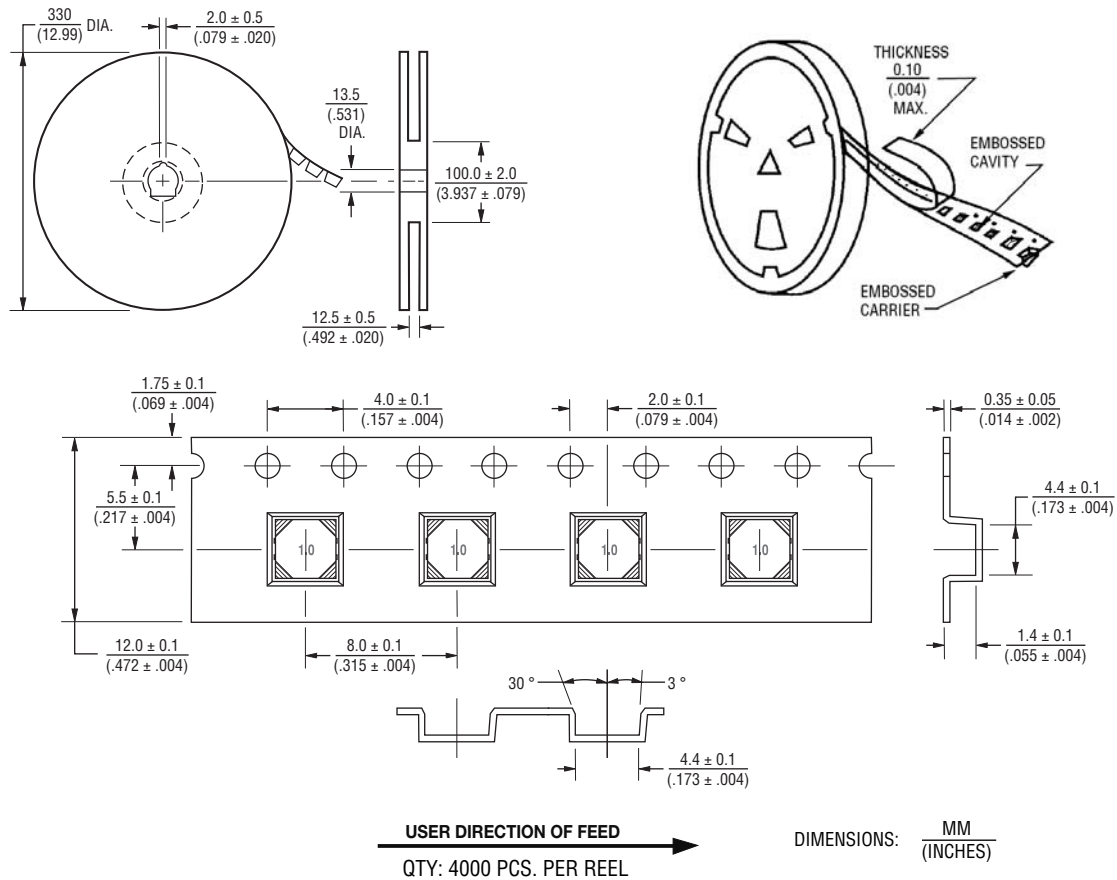

**BOURNS®**

Asia-Pacific: Tel: +886-2 2562-4117 • Fax: +886-2 2562-4116

EMEA: Tel: +36 88 520 390 • Fax: +36 88 520 211

The Americas: Tel: +1-951 781-5500 • Fax: +1-951 781-5700



[www.bourns.com](http://www.bourns.com)

REV. 01/15

The device characteristics and parameters in this data sheet can and do vary in different applications and actual device performance may vary over time. Specifications are subject to change without notice. Users should verify actual device performance in their specific applications.

## Looking for pricing, stock, or lifecycle information?

Click below to explore more details on WIN SOURCE:

-  [View SRN4012-3R3M on WIN SOURCE](#)
-  [Bourns Inc. Information](#)

## Optimize Your Supply Chain with WIN SOURCE Solutions

-  Global Sourcing Solution
-  Obsolete Management
-  Cost Control Management
-  Shortage Management
-  Alternative Solution
-  Excess Inventory Management