



THE DATASHEET OF
SI53102-A3-GM



Si53102-A1/A2/A3 Data Sheet

PCI-Express Gen 1, Gen 2, Gen 3, and Gen 4 1:2 Fan-out Clock Buffer

Si53102-A1/A2/A3 is a family of high-performance 1:2 PCIe fan output buffers. This low-additive-jitter clock buffer family is compliant to PCIe Gen 1, Gen 2, Gen 3, and Gen 4 specifications. The ultra-small footprint (1.4x1.6 mm) and industry-leading low power consumption make the Si53102-A1/A2/A3 the ideal clock solution for consumer and embedded applications. Measuring PCIe clock jitter is quick and easy with the Skyworks PCIe Clock Jitter Tool. Download it for free at <https://www.skyworksinc.com/en/application-pages/pci-express-learning-center>.

Applications

- Network Attached Storage
- Multi-function Printer
- Wireless Access Point
- Server/Storage

KEY FEATURES

- PCI-Express Gen 1, Gen 2, Gen 3, and Gen 4 common clock compliant
- Two low-power PCIe clock outputs
- Supports Serial-ATA (SATA) at 100 MHz
- No termination resistors required for differential clocks
- 2.5 V or 3.3 V Power supply
- Spread Spectrum Tolerant
- Extended Temperature Range
 - -40 to 85 °C
- Small package 8-pin TDFN (1.4 x 1.6 mm)
- For PCIe Gen 1: Si53102-A1
- For PCIe Gen 2: Si53102-A2
- For PCIe Gen 3/4: Si53102-A3

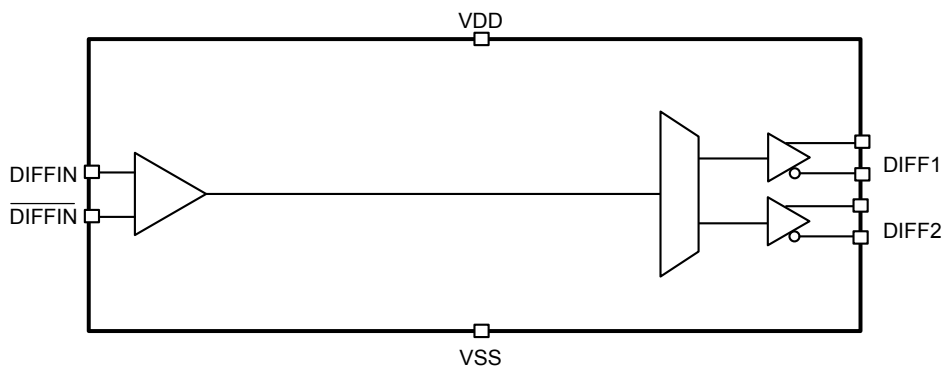

1. Ordering Guide

Table 1.1. Ordering Guide

Part Number	Package Type	Temperature
Si53102-A1-GM	8-pin TDFN	Extended, –40 to 85 °C
Si53102-A1-GMR	8-pin TDFN—Tape and Reel	Extended, –40 to 85 °C
Si53102-A2-GM	8-pin TDFN	Extended, –40 to 85 °C
Si53102-A2-GMR	8-pin TDFN—Tape and Reel	Extended, –40 to 85 °C
Si53102-A3-GM	8-pin TDFN	Extended, –40 to 85 °C
Si53102-A3-GMR	8-pin TDFN—Tape and Reel	Extended, –40 to 85 °C

Table of Contents

1. Ordering Guide	2
2. Electrical Specifications	4
3. Test and Measurement Setup	7
4. Recommended Design Guideline	9
5. Pin Descriptions	10
6. Package Outline	11
7. Land Pattern	13
8. Revision History	14
8.1 Revision 1.0	.14
8.2 Revision 1.1	.14
8.3 Revision 1.2	.14
8.4 Revision 1.3	.14
8.5 Revision 1.4	.14

2. Electrical Specifications

Table 2.1. Recommended Operating Conditions

Parameter	Symbol	Test Condition	Min	Typ	Max	Unit
Supply Voltage (3.3 V Supply)	V_{DD}	3.3 V \pm 10%	2.97	3.3	3.63	V
Supply Voltage (2.5 V Supply)	V_{DD}	2.5 V \pm 10%	2.25	2.5	2.75	V

Table 2.2. DC Electrical Specifications

Parameter	Symbol	Test Condition	Min	Typ	Max	Unit
Operating Voltage (V_{DD} = 3.3 V)	V_{DD}	3.3 V \pm 10%	2.97	3.30	3.63	V
Operating Voltage (V_{DD} = 2.5 V)	V_{DD}	2.5 V \pm 10%	2.25	2.5	2.75	V
Operating Supply Current	I_{DD}	Full Active	—	—	15	mA
Input Pin Capacitance	C_{IN}	Input Pin Capacitance	—	3	5	pF
Output Pin Capacitance	C_{OUT}	Output Pin Capacitance	—	—	5	pF

Table 2.3. AC Electrical Specifications^{1, 2, 3}

Parameter	Symbol	Condition	Min	Typ	Max	Unit
DIFFIN at 0.7 V						
Input frequency	F_{in}		10	100	175	MHz
DIFFIN and DIFFINb Rising/Falling Slew Rate	T_R / T_F	Single ended measurement: $V_{OL} = 0.175$ to $V_{OH} = 0.525$ V (Averaged)	0.6	—	4	V/ns
Differential Input High Voltage	V_{IH}		150	—	—	mV
Differential Input Low Voltage	V_{IL}		—	—	-150	mV
Crossing Point Voltage at 0.7 V Swing	V_{OX}	Single-ended measurement	250	—	550	mV
Vcross Variation Over All edges	ΔV_{OX}	Single-ended measurement	—	—	140	mV
Differential Ringback Voltage	V_{RB}		-100	—	100	mV
Time before Ringback Allowed	T_{STABLE}		500	—	—	ps
Absolute Maximum Input Voltage	V_{MAX}			—	1.15	V
Absolute Minimum Input Voltage	V_{MIN}		-0.3	—	—	V

Parameter	Symbol	Condition	Min	Typ	Max	Unit
DIFFIN and DIFFINb Duty Cycle	T_{DC}	Measured at crossing point VOX	45	—	55	%
Rise/Fall Matching	T_{RFM}	Determined as a fraction of $2 \times (TR - TF)/(TR + TF)$	—	—	20	%
DIFF Clocks						
Duty Cycle	T_{DC}	Measured at crossing point VOX	45	—	55	%
Output Skew	T_{SKEW}	Measured at 0 V differential	—	—	100	ps
Frequency Accuracy	F_{ACC}	All output clocks	—	—	100	ppm
Slew Rate	$t_{r/f2}$	Measured differentially from ± 150 mV	0.6	—	4.0	V/ns
PCIe Gen 1 Pk-Pk Additive Jitter	$Pk-Pk_{GEN1}$	PCIe Gen 1 Si53102-A1	—	—	10	ps
PCIe Gen 2 Additive Phase Jitter	RMS_{GEN2}	10 kHz < F < 1.5 MHz, Si53102-A2	—	—	0.50	ps
PCIe Gen 2 Additive Phase Jitter	RMS_{GEN2}	1.5 MHz < F < Nyquist, Si53102-A2	—	—	0.50	ps
PCIe Gen 3 Additive Phase Jitter	RMS_{GEN3}	Includes PLL BW 2–4 MHz, CDR = 10 MHz, Si53102-A3, VDD=3.3 V	—	—	0.22	ps
		Includes PLL BW 2–4 MHz, CDR = 10 MHz, Si53102-A3, VDD=2.5V	—	—	0.25	ps
PCIe Gen 4 Additive Phase Jitter	RMS_{GEN4}	PCIe Gen4, VDD=3.3V	—	—	0.22	ps
		PCIe Gen4, VDD=2.5V			0.25	ps
Crossing Point Voltage at 0.7 V Swing	V_{OX}	VDD = 3.3 V	300	—	550	mV
		VDD = 2.5 V	200	—	550	mV
Enable/Disable and Setup						
Clock Stabilization from Powerup	T_{STABLE}	Power up to first output	—	—	3.0	ms
Note:						
1. Visit www.pcisig.com for complete PCIe specifications						
2. Gen 4 specifications based on the PCI-Express Base Specification 4.0 rev. 0.5.						
3. Download the Skyworks PCIe Clock Jitter Tool at https://www.skyworksinc.com/en/application-pages/pci-express-learning-center .						

Table 2.4. Thermal Conditions

Parameter	Symbol	Condition	Min	Typ	Max	Unit
Temperature, Storage	T_S	Non-functional	-65		150	°C
Temperature, Operating Ambient	T_A	Functional	-40		85	°C
Temperature, Junction	T_J	Functional	—		150	°C
Dissipation, Junction to Case	θ_{JC}	JEDEC (JESD 51)	—		38.3	°C/W
Dissipation, Junction to Ambient	θ_{JA}	JEDEC (JESD 51)	—		90.4	°C/W

Table 2.5. Absolute Maximum Conditions

Parameter	Symbol	Condition	Min	Typ	Max	Unit
Main Supply Voltage	$V_{DD_3.3V}$		—		4.6	V
Input Voltage	V_{IN}	Relative to V_{SS}	-0.5		4.6	V_{DC}
ESD Protection (Human Body Model)	ESD_{HBM}	JEDEC (JESD 22-A114)	2000		—	V
Flammability Rating	UL-94	UL (Class)	V-0			

3. Test and Measurement Setup

The following figures show the test load configurations for the differential clock signals.

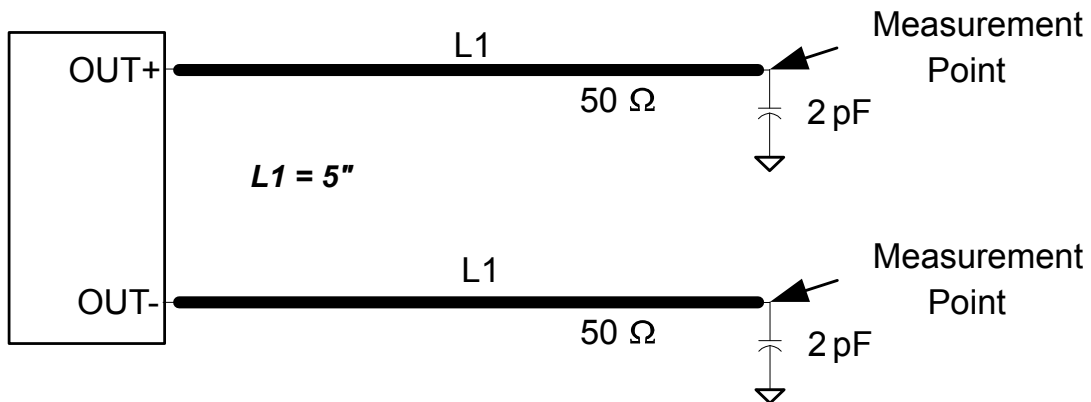

Figure 3.1. 0.7 V Differential Load Configuration

The outputs from this device can also support LVDS, LVPECL, or CML differential signaling levels using alternative termination. For recommendations on how to achieve this, see [“AN781: Alternative Output Termination for Si5211x, Si5213x, Si5214x, Si5216x, Si5310x, Si5311x, and Si5315x PCIe Clock Generator and Buffer Families.”](#)

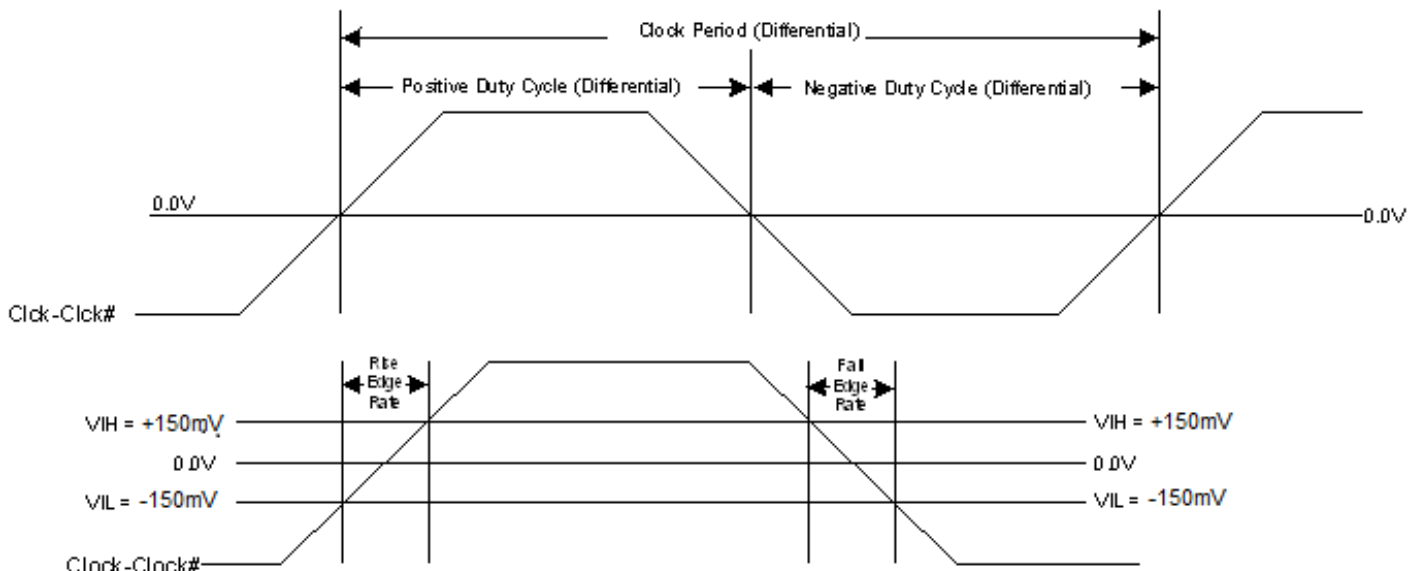

Figure 3.2. Differential Measurement for Differential Output Signals (AC Parameters Measurement)

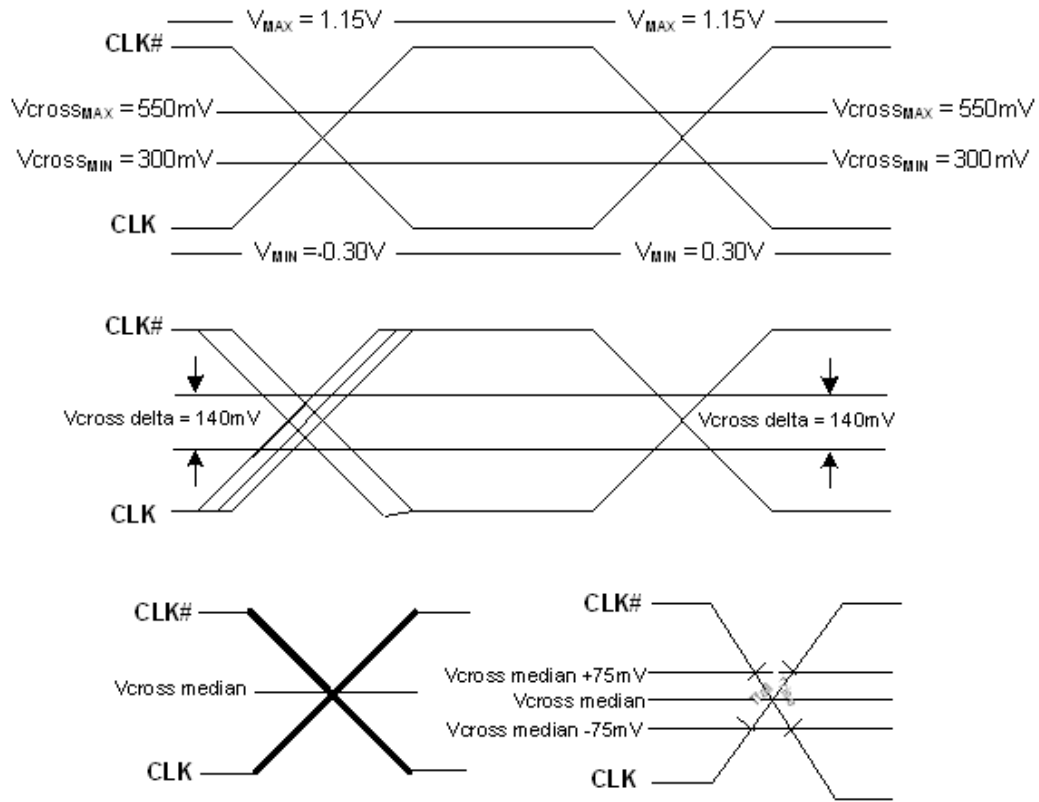

Figure 3.3. Single-Ended Measurement for Differential Output Signals (AC Parameters Measurement)

4. Recommended Design Guideline

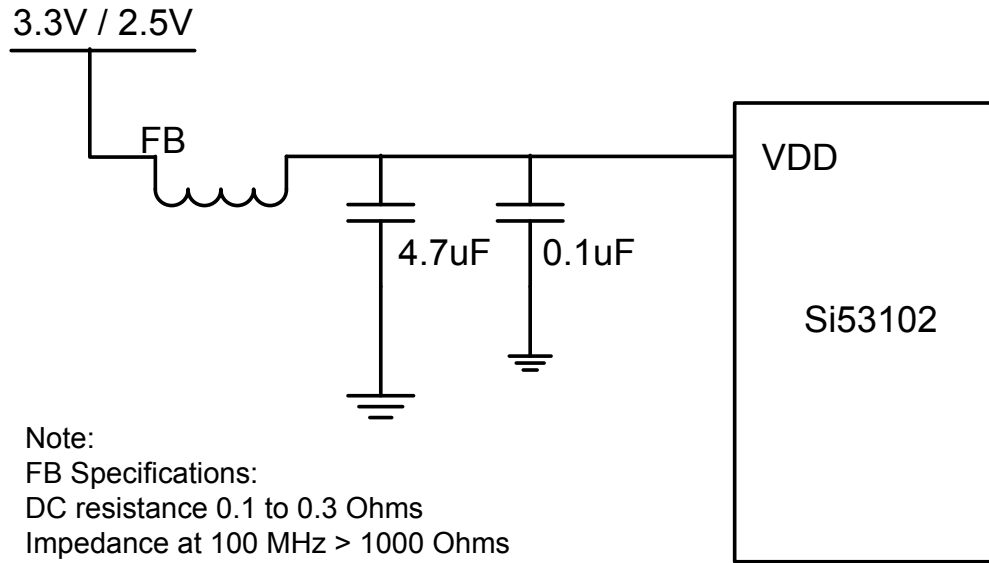

Figure 4.1. Recommended Application Schematic

5. Pin Descriptions

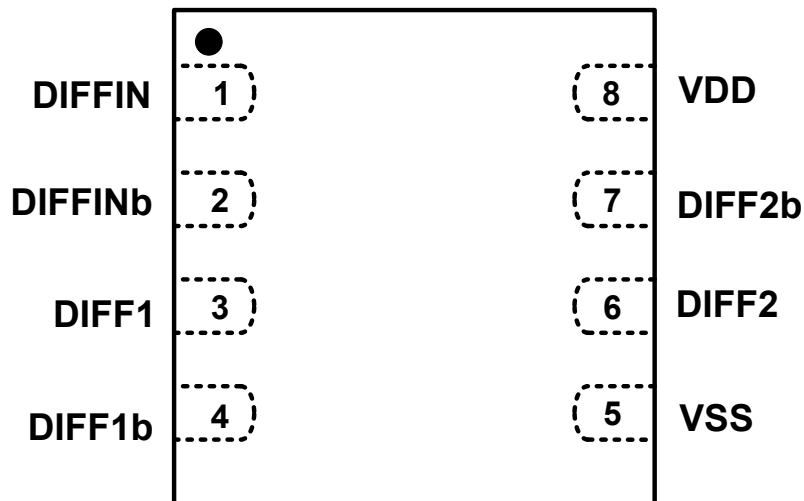

Figure 5.1. 8-Pin TDFN

Table 5.1. Si53102-Ax-GM 8-Pin TDFN Descriptions

Pin #	Name	Type	Description
1	DIFFIN	O, DIF	0.7 V, 100 MHz differentials clock input
2	DIFFINb	O, DIF	0.7 V, 100 MHz differentials clock input
3	DIFF1	O, DIF	0.7 V, 100 MHz differential clock output
4	DIFF1b	O, DIF	0.7 V, 100 MHz differential clock output
5	GND	GND	Ground
6	DIFF2	O, DIF	0.7 V, 100 MHz differential clock output
7	DIFF2b	O, DIF	0.7 V, 100 MHz differential clock output
8	VDD	PWR	2.5 V or 3.3 V Power supply

6. Package Outline

The figure below illustrates the package details for the Si53102-A1-A2-A3 in an 8-Pin TDFN package. The table lists the values for the dimensions shown in the illustration.

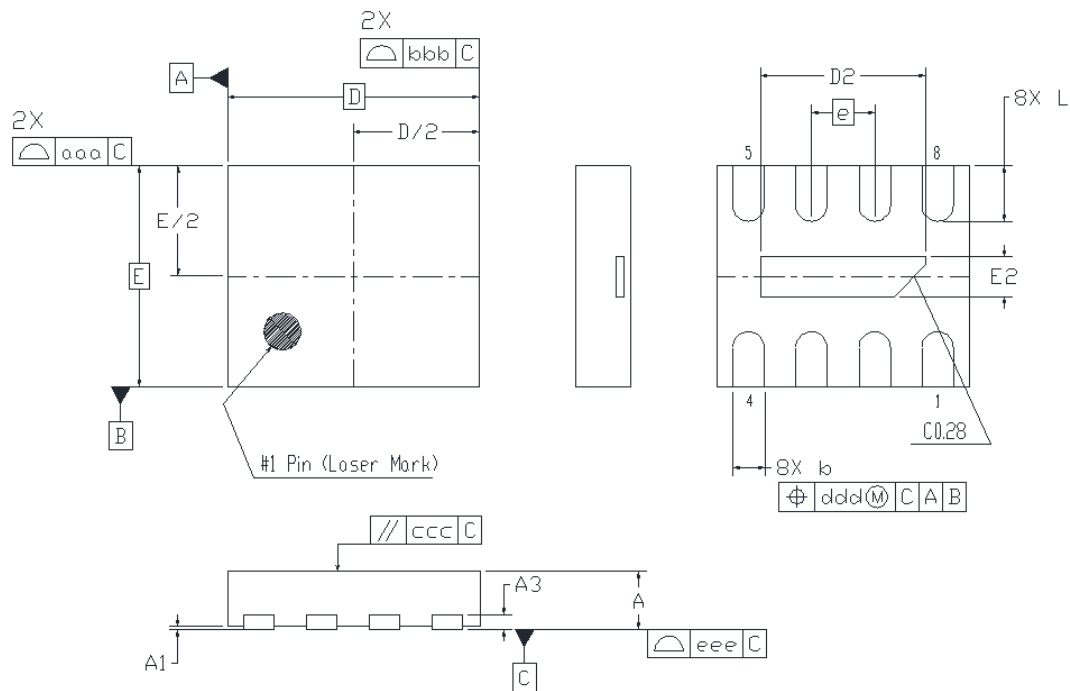

Figure 6.1. 8-Pin TDFN Package Drawing

Table 6.1. Package Diagram Dimensions

Dimension	Min	Nom	Max
A	0.70	0.75	0.80
A1	0.00	0.02	0.05
A3	0.20 REF.		
b	0.15	0.20	0.25
D	1.60 BSC		
D2	1.00	1.05	1.10
e	0.40 BSC		
E	1.40 BSC		
E2	0.20	0.25	0.30
L	0.30	0.35	0.40
aaa	0.10		
bbb	0.10		
ccc	0.10		
ddd	0.07		
eee	0.08		

Dimension	Min	Nom	Max
Note: 1. All dimensions shown are in millimeters (mm) unless otherwise noted. 2. Dimensioning and Tolerancing per ANSI Y14.5M-1994. 3. Recommended card reflow profile is per the JEDEC/IPC J-STD-020 specification for Small Body Components.			

7. Land Pattern

The following figure illustrates the land pattern details for the Si53102-A1-A2-A3 in an 8-Pin TDFN package. The table lists the values for the dimensions shown in the illustration.

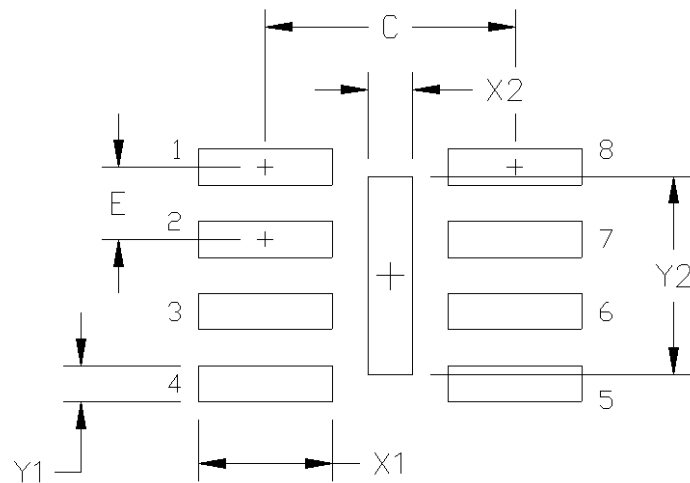

Figure 7.1. 8-Pin TDFN Land Pattern

Table 7.1. Land Pattern Dimensions

Dimension	mm
C1	1.40
E	0.40
X1	0.75
Y1	0.20
X2	0.25
Y2	1.10

Notes:

General

1. All dimensions shown are in millimeters (mm).
2. This Land Pattern Design is based on the IPC-7351 guidelines.
3. All dimensions shown are at Maximum Material Condition (MMC). Least Material Condition (LMC) is calculated based on a Fabrication Allowance of 0.05 mm.

Solder Mask Design

1. All metal pads are to be non-solder mask defined (NSMD). Clearance between the solder mask and the metal pad is to be 60 μm minimum, all the way around the pad.

Stencil Design

1. A stainless steel, laser-cut and electro-polished stencil with trapezoidal walls should be used to assure good solder paste release.
2. The stencil thickness should be 0.125 mm (5 mils).
3. The ratio of stencil aperture to land pad size should be 1:1 for all pads.

Card Assembly

1. A No-Clean, Type-3 solder paste is recommended.
2. The recommended card reflow profile is per the JEDEC/IPC J-STD-020 specification for Small Body Components.

8. Revision History

8.1 Revision 1.0

July 25, 2013

Full-production revision from Rev 0.4

- Updated AC Electrical Specifications table.
 - Updated input frequency min and max specs.
- Updated Test and Measurement Setup section.
 - Added text and reference to AN781.

8.2 Revision 1.1

August 5, 2013

- Moved Recommended Design Guideline section.
- Updated Pin Descriptions.
- Updated Package Outline.
- Added Land Pattern.

8.3 Revision 1.2

December 2, 2015

- Updated Features.
- Updated Description.
- Updated AC Electrical Specifications table.

8.4 Revision 1.3

July 21, 2017

- Updated IDD max specification.
- Separated VOX into 2.5 V and 3.3 V specifications.
- Separated PCIe Gen3 jitter into 2.5 V and 3.3 V specifications.
- Separated PCIe Gen4 jitter into 2.5 V and 3.3 V specifications.

8.5 Revision 1.4

July 28, 2017

- Updated [2. Electrical Specifications](#).
 - Updated PCIe Gen 4 Additive Phase Jitter max spec.
- Updated [6. Package Outline](#).
 - Added notes to [Table 6.1 Package Diagram Dimensions on page 11](#).



SKYWORKS®

**Connecting Everyone
and Everything,
All the Time**



Portfolio

www.skyworksinc.com

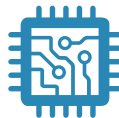

Quality

www.skyworksinc.com/quality



Support & Resources

www.skyworksinc.com/support

Copyright © 2021 Skyworks Solutions, Inc. All Rights Reserved.

Information in this document is provided in connection with Skyworks Solutions, Inc. ("Skyworks") products or services. These materials, including the information contained herein, are provided by Skyworks as a service to its customers and may be used for informational purposes only by the customer. Skyworks assumes no responsibility for errors or omissions in these materials or the information contained herein. Skyworks may change its documentation, products, services, specifications or product descriptions at any time, without notice. Skyworks makes no commitment to update the materials or information and shall have no responsibility whatsoever for conflicts, incompatibilities, or other difficulties arising from any future changes.

No license, whether express, implied, by estoppel or otherwise, is granted to any intellectual property rights by this document. Skyworks assumes no liability for any materials, products or information provided hereunder, including the sale, distribution, reproduction or use of Skyworks products, information or materials, except as may be provided in Skyworks' Terms and Conditions of Sale.

THE MATERIALS, PRODUCTS AND INFORMATION ARE PROVIDED "AS IS" WITHOUT WARRANTY OF ANY KIND, WHETHER EXPRESS, IMPLIED, STATUTORY, OR OTHERWISE, INCLUDING FITNESS FOR A PARTICULAR PURPOSE OR USE, MERCHANTABILITY, PERFORMANCE, QUALITY OR NON-INFRINGEMENT OF ANY INTELLECTUAL PROPERTY RIGHT; ALL SUCH WARRANTIES ARE HEREBY EXPRESSLY DISCLAIMED. SKYWORKS DOES NOT WARRANT THE ACCURACY OR COMPLETENESS OF THE INFORMATION, TEXT, GRAPHICS OR OTHER ITEMS CONTAINED WITHIN THESE MATERIALS. SKYWORKS SHALL NOT BE LIABLE FOR ANY DAMAGES, INCLUDING BUT NOT LIMITED TO ANY SPECIAL, INDIRECT, INCIDENTAL, STATUTORY, OR CONSEQUENTIAL DAMAGES, INCLUDING WITHOUT LIMITATION, LOST REVENUES OR LOST PROFITS THAT MAY RESULT FROM THE USE OF THE MATERIALS OR INFORMATION, WHETHER OR NOT THE RECIPIENT OF MATERIALS HAS BEEN ADVISED OF THE POSSIBILITY OF SUCH DAMAGE.

Skyworks products are not intended for use in medical, lifesaving or life-sustaining applications, or other equipment in which the failure of the Skyworks products could lead to personal injury, death, physical or environmental damage. Skyworks customers using or selling Skyworks products for use in such applications do so at their own risk and agree to fully indemnify Skyworks for any damages resulting from such improper use or sale.

Customers are responsible for their products and applications using Skyworks products, which may deviate from published specifications as a result of design defects, errors, or operation of products outside of published parameters or design specifications. Customers should include design and operating safeguards to minimize these and other risks. Skyworks assumes no liability for applications assistance, customer product design, or damage to any equipment resulting from the use of Skyworks products outside of Skyworks' published specifications or parameters.



Skyworks, the Skyworks symbol, Sky5®, SkyOne®, SkyBlue™, Skyworks Green™, Clockbuilder®, DSPLL®, ISOModem®, ProSLIC®, and SiPHY® are trademarks or registered trademarks of Skyworks Solutions, Inc. or its subsidiaries in the United States and other countries. Third-party brands and names are for identification purposes only and are the property of their respective owners. Additional information, including relevant terms and conditions, posted at www.skyworksinc.com, are incorporated by reference.

Skyworks Solutions, Inc. | Nasdaq: SWKS | sales@skyworksinc.com | www.skyworksinc.com

USA: 781-376-3000 | Asia: 886-2-2735 0399 | Europe: 33 (0)1 43548540 | [in](https://www.linkedin.com/company/skyworks) [f](https://www.facebook.com/skyworks) [t](https://twitter.com/skyworks) [y](https://www.youtube.com/skyworks)

Looking for pricing, stock, or lifecycle information?

Click below to explore more details on WIN SOURCE:

-  [View S153102-A3-GM on WIN SOURCE](#)
-  [Skyworks Solutions Inc. Information](#)

Optimize Your Supply Chain with WIN SOURCE Solutions

-  Global Sourcing Solution
-  Obsolete Management
-  Cost Control Management
-  Shortage Management
-  Alternative Solution
-  Excess Inventory Management