



**THE DATASHEET OF
SI5341B-D10789-GMR**



Si5341/40 Rev D Data Sheet

Low-Jitter, 10 or 4-Output, Any-Frequency, Any-Output Clock Generator

The any-frequency, any-output Si5341/40 clock generators combine a wide-band PLL with proprietary MultiSynth™ fractional synthesizer technology to offer a versatile and high performance clock generator platform. This highly flexible architecture is capable of synthesizing a wide range of integer and non-integer related frequencies up to 1 GHz on 10 differential clock outputs while delivering sub-100 fs rms phase jitter performance with 0 ppm error. Each of the clock outputs can be assigned its own format and output voltage enabling the Si5341/40 to replace multiple clock ICs and oscillators with a single device making it a true "clock tree on a chip."

The Si5341/40 can be quickly and easily configured using ClockBuilderPro software. Custom part numbers are automatically assigned using a [ClockBuilder Pro™](#) for fast, free, and easy factory pre-programming or the Si5341/40 can be programmed via I²C and SPI serial interfaces.

Applications:

- Clock tree generation replacing XOs, buffers, signal format translators
- Any-frequency clock translation
- Clocking for FPGAs, processors, memory
- Ethernet switches/routers
- OTN framers/mappers/processors
- Test equipment and instrumentation
- Broadcast video



KEY FEATURES

- Generates any combination of output frequencies from any input frequency
- Ultra-low jitter of 90 fs rms
- Input frequency range:
 - External crystal: 25 to 54 MHz
 - Differential clock: 10 to 750 MHz
 - LVCMOS clock: 10 to 250 MHz
- Output frequency range:
 - Differential: 100 Hz to 1028 MHz
 - LVCMOS: 100 Hz to 250 MHz
- Highly configurable outputs compatible with LVDS, LVPECL, LVCMOS, CML, and HCSL with programmable signal amplitude
- Si5341: 4 input, 10 output, 64-QFN 9x9 mm
- Si5340: 4 input, 4 output, 44-QFN 7x7 mm

1. Features List

The Si5341/40 Rev D features are listed below:

- Generates any combination of output frequencies from any input frequency
- Ultra-low jitter of 90 fs rms
- Input frequency range:
 - External crystal: 25 to 54 MHz
 - Differential clock: 10 to 750 MHz
 - LVCMOS clock: 10 to 250 MHz
- Output frequency range:
 - Differential: 100 Hz to 1028 MHz
 - LVCMOS: 100 Hz to 250 MHz
- Highly configurable outputs compatible with LVDS, LVPECL, LVCMOS, CML, and HCSL with programmable signal amplitude
- Locks to gapped clock inputs
- Optional zero delay mode
- Glitchless on the fly output frequency changes
- DCO mode: as low as 0.001 ppb steps
- Core voltage
 - VDD: 1.8 V \pm 5%
 - VDDA: 3.3 V \pm 5%
- Independent output clock supply pins
 - 3.3 V, 2.5 V, or 1.8 V
- Serial interface: I²C or SPI
- In-circuit programmable with non-volatile OTP memory
- ClockBuilder Pro software simplifies device configuration
- Si5341: 4 input, 10 output, 64-QFN 9x9 mm
- Si5340: 4 input, 4 output, 44-QFN 7x7 mm
- Temperature range: -40 to +85 °C
- Pb-free, RoHS-6 compliant

2. Ordering Guide

Table 2.1. Si5341/40 Ordering Guide

Ordering Part Number (OPN)	Number of Input/Output Clocks	Output Clock Frequency Range (MHz)	Frequency Synthesis Mode	Package	Temperature Range
Si5341					
Si5341A-D-GM ^{1, 2}	4/10	0.0001 to 1028 MHz	Integer and	64-QFN 9x9 mm	–40 to 85 °C
Si5341B-D-GM ^{1, 2}		0.0001 to 350 MHz	Fractional		
Si5341C-D-GM ^{1, 2}		0.0001 to 1028 MHz	Integer Only		
Si5341D-D-GM ^{1, 2}		0.0001 to 350 MHz			
Si5340					
Si5340A-D-GM ^{1, 2}	4/4	0.0001 to 1028 MHz	Integer and	44-QFN 7x7 mm	–40 to 85 °C
Si5340B-D-GM ^{1, 2}		0.0001 to 350 MHz	Fractional		
Si5340C-D-GM ^{1, 2}		0.0001 to 1028 MHz	Integer Only		
Si5340D-D-GM ^{1, 2}		0.0001 to 350 MHz			
Si5341/40-D-EVB					
Si5341-D-EVB	—	—	—	Evaluation Board	—
Si5340-D-EVB					
Note:					
<ol style="list-style-type: none"> 1. Add an R at the end of the OPN to denote tape and reel ordering options. 2. Custom, factory pre-programmed devices are available. Ordering part numbers are assigned by Skyworks and the ClockBuilder Pro software utility. Custom part number format is: e.g., Si5341A-Dxxxxx-GM, where "xxxxx" is a unique numerical sequence representing the preprogrammed configuration. 3. See 3.9 Custom Factory Preprogrammed Devices and 3.10 Enabling Features and/or Configuration Settings Not Available in ClockBuilder Pro for Factory Pre-Programmed Devices for important notes about specifying a preprogrammed device to use features or device register settings not yet available in CBPro. 					



*See Ordering Guide table for current product revision
** 5 digits; assigned by ClockBuilder Pro

Figure 2.1. Ordering Part Number Fields

Table of Contents

1. Features List	2
2. Ordering Guide	3
3. Functional Description	7
3.1 Power-up and Initialization	7
3.2 Frequency Configuration	7
3.3 Inputs	7
3.3.1 XA/XB Clock and Crystal Input	8
3.3.2 Input Clocks (IN0, IN1, IN2)	8
3.3.3 Input Selection (IN0, IN1, IN2, XA/XB)	9
3.4 Fault Monitoring	9
3.4.1 Status Indicators	9
3.4.2 Interrupt Pin (INTRb)	9
3.5 Outputs	10
3.5.1 Output Signal Format	10
3.5.2 Differential Output Terminations	10
3.5.3 Programmable Common Mode Voltage for Differential Outputs	11
3.5.4 LVCMOS Output Terminations	11
3.5.5 LVCMOS Output Impedance and Drive Strength Selection	11
3.5.6 LVCMOS Output Signal Swing	11
3.5.7 LVCMOS Output Polarity	11
3.5.8 Output Enable/Disable	11
3.5.9 Output Driver State When Disabled	12
3.5.10 Synchronous/Asynchronous Output Disable Feature	12
3.5.11 Zero Delay Mode	12
3.5.12 Output Crosspoint	12
3.5.13 Digitally Controlled Oscillator (DCO) Modes	13
3.6 Power Management	13
3.7 In-Circuit Programming	13
3.8 Serial Interface	13
3.9 Custom Factory Preprogrammed Devices	13
3.10 Enabling Features and/or Configuration Settings Not Available in ClockBuilder Pro for Factory Pre-Programmed Devices	14
4. Register Map	16
5. Electrical Specifications	17
6. Typical Application Schematic	32
7. Detailed Block Diagrams	33
8. Typical Operating Characteristics	35
9. Pin Descriptions	37

10. Package Outlines 42
 10.1 Si5341 9x9 mm 64-QFN Package Diagram 42
 10.2 Si5340 7x7 mm 44-QFN Package Diagram 43
11. PCB Land Pattern 44
12. Top Marking 46
13. Device Errata 47
14. Revision History. 48

3. Functional Description

The Si5340/41-D combines a wide band PLL with next generation MultiSynth technology to offer the industry's most versatile and high performance clock generator. The PLL locks to either an external **crystal** between XA/XB or to an external **clock** connected to XA/XB or IN0, 1, 2. A fractional or integer multiplier takes the selected input clock or crystal frequency up to a very high frequency that is then divided by the MultiSynth output stage to any frequency in the range of 100 Hz to 1 GHz on each output. The MultiSynth stage can divide by both integer and fractional values. The high-resolution fractional MultiSynth dividers enable true any-frequency input to any-frequency on any of the outputs. The output drivers offer flexible output formats which are independently configurable on each of the outputs. This clock generator is fully configurable via its serial interface (I²C/SPI) and includes in-circuit programmable non-volatile memory.

3.1 Power-up and Initialization

Once power is applied, the device begins an initialization period where it downloads default register values and configuration data from NVM and performs other initialization tasks. Communicating with the device through the serial interface is possible once this initialization period is complete. No clocks will be generated until the initialization is done. There are two types of resets available. A hard reset is functionally similar to a device power-up. All registers will be restored to the values stored in NVM, and all circuits will be restored to their initial state including the serial interface. A hard reset is initiated using the RSTb pin or by asserting the hard reset bit. A soft reset bypasses the NVM download. It is simply used to initiate register configuration changes.



Figure 3.1. Si5341 Power-Up and Initialization

3.2 Frequency Configuration

The phase-locked loop is fully contained and does not require external loop filter components to operate. Its function is to phase lock to the selected input and provide a common reference to the MultiSynth high-performance fractional dividers.

A crosspoint mux connects any of the MultiSynth divided frequencies to any of the outputs drivers. Additional output integer dividers provide further frequency division by an even integer from 2 to $(2^{25})-2$. The frequency configuration of the device is programmed by setting the input dividers (P), the PLL feedback fractional divider (Mn/Md), the MultiSynth fractional dividers (Nn/Nd), and the output integer dividers (R). Skyworks's ClockBuilder Pro configuration utility determines the optimum divider values for any desired input and output frequency plan.

3.3 Inputs

The Si5340/41-D requires either an external crystal at its XA/XB pins or an external clock at XA/XB or IN0, 1, 2.

3.3.1 XA/XB Clock and Crystal Input

An internal crystal oscillator exists between pin XA and XB. When this oscillator is enabled, an external crystal connected across these pins will oscillate and provide a clock input to the PLL. A crystal frequency of 25 MHz can be used although crystals in the frequency range of 48 MHz to 54 MHz are recommended for best jitter performance. Frequency offsets due to C_L mismatch can be adjusted using the frequency adjustment feature which allows frequency adjustments of ± 1000 ppm. The [Si5340/41 Family Reference Manual](#) provides additional information on PCB layout recommendations for the crystal to ensure optimum jitter performance. Refer to [Table 5.12 Crystal Specifications on page 30](#) for crystal specifications.

To achieve optimal jitter performance and minimize BOM cost, a crystal is recommended on the XA/XB reference input. A clock (e.g., XO) may be used in lieu of the crystal, but it will result in higher output jitter. See the Si5340/41 Reference Manual for more information.

Selection between the external XTAL or input clock is controlled by register configuration. The internal crystal load capacitors (C_L) are disabled in the input clock mode. Refer to [Table 5.3 Input Clock Specifications on page 19](#) for the input clock requirements at XAXB. Both a single-ended or a differential input clock can be connected to the XA/XB pins as shown in the figure below. A P_{XAXB} divider is available to accommodate external clock frequencies higher than 54 MHz.



Figure 3.2. XAXB External Crystal and Clock Connections

Note: See [Table 5.3 Input Clock Specifications on page 19](#) for more information.

3.3.2 Input Clocks (IN0, IN1, IN2)

A differential or single-ended clock can be applied at IN2, IN1, or IN0.

The recommended input termination schemes are can be found in [Si5341/40 Rev D Family Reference Manual](#).

3.3.3 Input Selection (IN0, IN1, IN2, XA/XB)

The active clock input is selected using the IN_SEL[1:0] pins or by register control. A register bit determines input selection as pin or register selectable. There are internal pull ups on the IN_SEL pins.

Table 3.1. Manual Input Selection Using IN_SEL[1:0] Pins

IN_SEL[1:0]		Selected Input
0	0	IN0
0	1	IN1
1	0	IN2
1	1	XA/XB

3.4 Fault Monitoring

The Si5340/41-D provides fault indicators which monitor loss of signal (LOS) of the inputs (IN0, IN1, IN2, XA/XB, FB_IN) and loss of lock (LOL) for the PLL as shown in the figure below.



Figure 3.3. LOS and LOL Fault Monitors

3.4.1 Status Indicators

The state of the status monitors are accessible by reading registers through the serial interface or with dedicated pin (LOLb). Each of the status indicator register bits has a corresponding sticky bit in a separate register location. Once a status bit is asserted its corresponding sticky bit (_FLG) will remain asserted until cleared. Writing a logic zero to a sticky register bit clears its state.

3.4.2 Interrupt Pin (INTRb)

An interrupt pin (INTRb) indicates a change in state with any of the status registers. All status registers are maskable to prevent assertion of the interrupt pin. The state of the INTRb pin is reset by clearing the status registers.

3.5 Outputs

The Si5341 supports 10 differential output drivers which can be independently configured as differential or LVCMOS. The Si5340 supports 4 output drivers independently configurable as differential or LVCMOS.

3.5.1 Output Signal Format

The differential output amplitude and common mode voltage are both fully programmable and compatible with a wide variety of signal formats including LVDS and LVPECL. In addition to supporting differential signals, any of the outputs can be configured as LVCMOS (3.3 V, 2.5 V, or 1.8 V) drivers providing up to 20 single-ended outputs, or any combination of differential and single-ended outputs.

3.5.2 Differential Output Terminations

The differential output drivers support both ac-coupled and dc-coupled terminations as shown in the figure below.



Figure 3.4. Supported Differential Output Terminations

Note: See the [Si5341/40 Rev D Family Reference Manual](#) for resistor values.

3.5.3 Programmable Common Mode Voltage for Differential Outputs

The common mode voltage (VCM) for the differential modes are programmable so that LVDS specifications can be met and for the best signal integrity with different supply voltages. When dc coupling the output driver it is essential that the receiver should have a relatively high common mode impedance so that the common mode current from the output driver is very small.

3.5.4 LVC MOS Output Terminations

LVC MOS outputs are typically dc-coupled, as shown in the figure below.



Figure 3.5. LVC MOS Output Terminations

3.5.5 LVC MOS Output Impedance and Drive Strength Selection

Each LVC MOS driver has a configurable output impedance. It is highly recommended that the minimum output impedance (strongest drive setting) is selected and a suitable series resistor (R_s) is chosen to match the trace impedance.

Table 3.2. Nominal Output Impedance vs. `OUTx_CMOS_DRV` (register)

VDDO	CMOS_DRIVE_Selection		
	OUTx_CMOS_DRV=1	OUTx_CMOS_DRV=2	OUTx_CMOS_DRV=3
3.3 V	38 Ω	30 Ω	22 Ω
2.5 V	43 Ω	35 Ω	24 Ω
1.8 V	—	46 Ω	31 Ω

Note: Refer to the [Si5340/41 Family Reference Manual](#) for more information on register settings.

3.5.6 LVC MOS Output Signal Swing

The signal swing (V_{OL}/V_{OH}) of the LVC MOS output drivers is set by the voltage on the VDDO pins. Each output driver has its own VDDO pin allowing a unique output voltage swing for each of the LVC MOS drivers.

3.5.7 LVC MOS Output Polarity

When a driver is configured as an LVC MOS output it generates a clock signal on both pins (OUTx and OUTxb). By default the clock on the OUTxb pin is generated with complementary polarity with the clock on the OUTx pin. The LVC MOS OUTx and OUTxb outputs can also be generated in phase.

3.5.8 Output Enable/Disable

The OEb pin provides a convenient method of disabling or enabling the output drivers. When the OEb pin is held high all outputs will be disabled. When held low, the outputs will be enabled. Outputs in the enabled state can be individually disabled through register control.

3.5.9 Output Driver State When Disabled

The disabled state of an output driver is configurable as: disable low or disable high.

3.5.10 Synchronous/Asynchronous Output Disable Feature

Outputs can be configured to disable synchronously or asynchronously. The default state is synchronous output disable. In synchronous disable mode the output will wait until a clock period has completed before the driver is disabled. This prevents unwanted runt pulses from occurring when disabling an output. In asynchronous disable mode the output clock will disable immediately without waiting for the period to complete.

3.5.11 Zero Delay Mode

A zero delay mode is available for applications that require fixed and consistent minimum delay between the selected input and outputs. The zero delay mode is configured by opening the internal feedback loop through software configuration and closing the loop externally as shown in the figure below. This helps to cancel out the internal delay introduced by the dividers, the crosspoint, the input, and the output drivers. Any one of the outputs can be fed back to the FB_IN pins, although using the output driver that achieves the shortest trace length will help to minimize the input-to-output delay. It is recommended to connect OUT9 (Si5341) or OUT3 (Si5340) to FB_IN for external feedback. The FB_IN input pins must be terminated and ac-coupled when zero delay mode is used. A differential external feedback path connection is necessary for best performance.

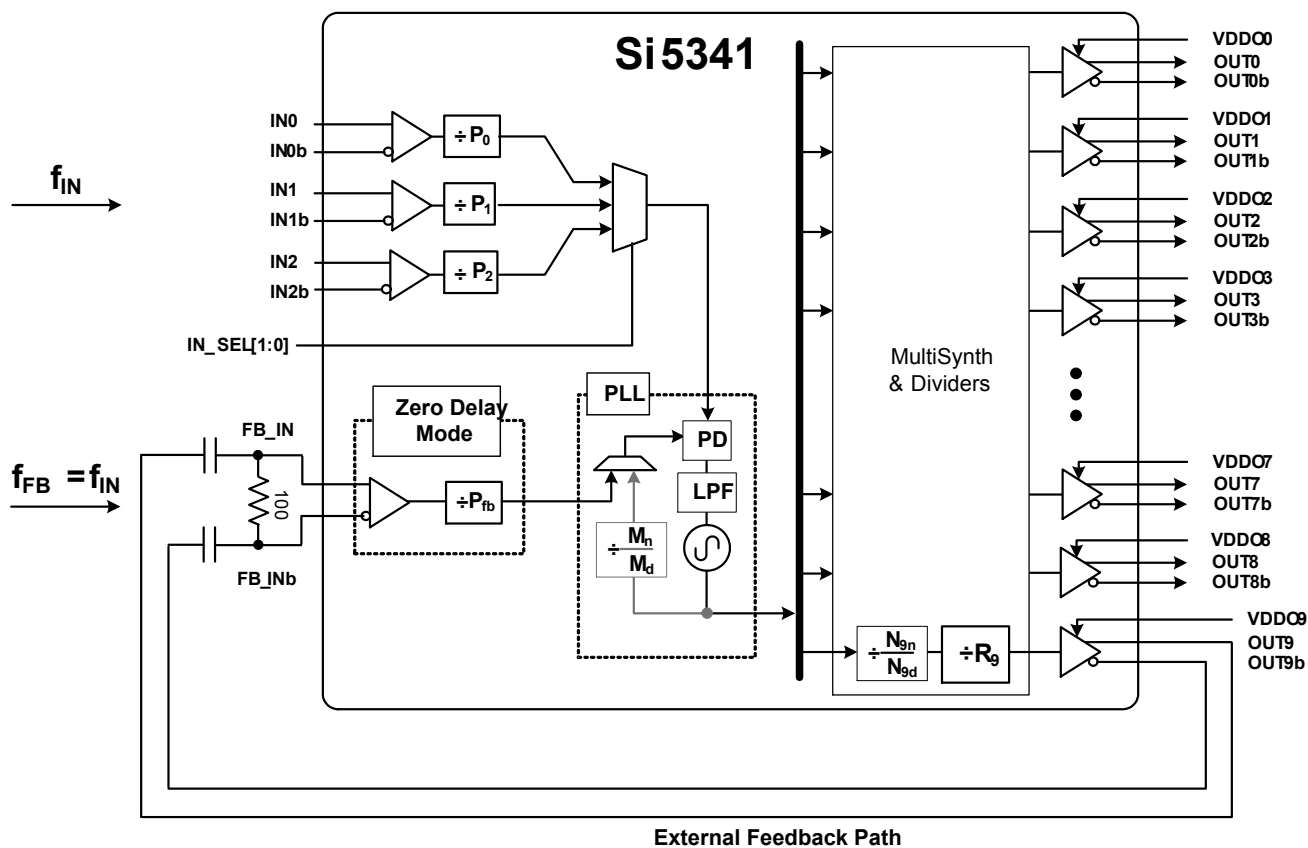

Figure 3.6. Si5341 Zero Delay Mode Setup

3.5.12 Output Crosspoint

The output crosspoint allows any of the N dividers to connect to any of the clock outputs.

3.5.13 Digitally Controlled Oscillator (DCO) Modes

Each MultiSynth can be digitally controlled so that all outputs connected to the MultiSynth change frequency in real time without any transition glitches. There are two ways to control the MultiSynth to accomplish this task:

- Use the Frequency Increment/Decrement Pins or register bits.
- Write directly to the numerator of the MultiSynth divider.

An output that is controlled as a DCO is useful for simple tasks such as frequency margining or CPU speed control. The output can also be used for more sophisticated tasks such as FIFO management by adjusting the frequency of the read or write clock to the FIFO or using the output as a variable Local Oscillator in a radio application.

3.5.13.1 DCO with Frequency Increment/Decrement Pins/Bits

Each of the MultiSynth fractional dividers can be independently stepped up or down in predefined steps with a resolution as low as 0.001 ppb. Setting of the step size and control of the frequency increment or decrement is accomplished by setting the step size with the 44 bit Frequency Step Word (FSTEPW). When the FINC or FDEC pin or register bit is asserted the output frequency will increment or decrement respectively by the amount specified in the FSTEPW.

3.5.13.2 DCO with Direct Register Writes

When a MultiSynth numerator and its corresponding update bit is written, the new numerator value will take effect and the output frequency will change without any glitches. The MultiSynth numerator and denominator terms can be left and right shifted so that the least significant bit of the numerator word represents the exact step resolution that is needed for your application.

3.6 Power Management

Several unused functions can be powered down to minimize power consumption. Consult the [Si5340/41 Family Reference Manual](#) and ClockBuilder Pro configuration utility for details.

3.7 In-Circuit Programming

The Si5341/40 is fully configurable using the serial interface (I²C or SPI). At power-up the device downloads its default register values from internal non-volatile memory (NVM). Application specific default configurations can be written into NVM allowing the device to generate specific clock frequencies at power-up. Writing default values to NVM is in-circuit programmable with normal operating power supply voltages applied to its V_{DD} and V_{DDA} pins. The NVM is two time writable. Once a new configuration has been written to NVM, the old configuration is no longer accessible. Refer to the [Si5340/41 Family Reference Manual](#) for a detailed procedure for writing registers to NVM.

3.8 Serial Interface

Configuration and operation of the Si5341/40 is controlled by reading and writing registers using the I²C or SPI interface. The I2C_SEL pin selects I²C or SPI operation. Communication with both 3.3 V and 1.8 V host is supported. The SPI mode operates in either 4-wire or 3-wire. See the [Si5340/41 Family Reference Manual](#) for details.

3.9 Custom Factory Preprogrammed Devices

For applications where a serial interface is not available for programming the device, custom pre-programmed parts can be ordered with a specific configuration written into NVM. A factory pre-programmed device will generate clocks at power-up. Custom, factory-pre-programmed devices are available. Use the ClockBuilder Pro custom part number wizard (<https://www.skyworksinc.com/en/application-pages/clockbuilder-pro-software>) to quickly and easily request and generate a custom part number for your configuration. In less than three minutes, you will be able to generate a custom part number with a detailed data sheet addendum matching your design's configuration. Once you receive the confirmation email with the data sheet addendum, simply place an order with your local Skyworks sales representative. Samples of your pre-programmed device will ship to you typically within two weeks.

3.10 Enabling Features and/or Configuration Settings Not Available in ClockBuilder Pro for Factory Pre-Programmed Devices

As with essentially all software utilities, ClockBuilder Pro is continuously updated and enhanced. By registering at <https://www.skyworksinc.com/> and opting in for updates to software, you will be notified whenever changes are made and what the impact of those changes are. This update process will ultimately enable ClockBuilder Pro users to access all features and register setting values documented in this data sheet and the [Si5341/40 Family Reference Manual](#). However, if you must enable or access a feature or register setting value so that the device starts up with this feature or a register setting, but the feature or register setting is NOT yet available in CBPro, you must contact a [Skyworks applications engineer](#) for assistance. An example of this type of feature or custom setting is the customizable amplitudes for the clock outputs. After careful review of your project file and custom requirements, a Skyworks applications engineer will email back your CBPro project file with your specific features and register settings enabled, using what is referred to as the manual "settings override" feature of CBPro. "Override" settings to match your request(s) will be listed in your design report file. Examples of setting "overrides" in a CBPro design report are shown below:

Table 3.3. Setting Overrides

Location	Name	Type	Target	Dec Value	Hex Value
0128[6:4]	OUT6_AMPL	User	OPN & EVB	5	5

Once you receive the updated design file, simply open it in CBPro. After you create a custom OPN, the device will begin operation after startup with the values in the NVM file, including the Skyworks-supplied override settings.



Figure 3.7. Flowchart to Order Custom Parts with Features not Available in CBPro

Note: Contact Skyworks Technical Support at <https://www.skyworksinc.com/en/Support>.

4. Register Map

Refer to the [Si5340/41 Family Reference Manual](#) for a complete list of register descriptions and settings.

5. Electrical Specifications

Table 5.1. Recommended Operating Conditions¹

($V_{DD}=1.8\text{ V} \pm 5\%$, $V_{DDA}=3.3\text{ V} \pm 5\%$, $T_A=-40\text{ to }85^\circ\text{C}$)

Parameter	Symbol	Min	Typ	Max	Units
Ambient Temperature	T_A	-40	25	85	°C
Junction Temperature	T_{JMAX}	—	—	125	°C
Core Supply Voltage	V_{DD}	1.71	1.80	1.89	V
	V_{DDA}	3.14	3.30	3.47	V
Output Driver Supply Voltage	V_{DDO}	3.14	3.30	3.47	V
		2.37	2.50	2.62	V
		1.71	1.80	1.89	V

Note:

1. All minimum and maximum specifications are guaranteed and apply across the recommended operating conditions. Typical values apply at nominal supply voltages and an operating temperature of 25 °C unless otherwise noted.

Table 5.2. DC Characteristics(V_{DD}=1.8V ± 5%, V_{DDA}=3.3V ± 5%, V_{DDO}=1.8V ± 5%, 2.5V ± 5%, or 3.3V ± 5%, T_A= -40 to 85°C)

Parameter	Symbol	Test Condition	Min	Typ	Max	Units
Core Supply Current ^{1, 2}	I _{DD}	Si5340/41	—	115	230	mA
	I _{DDA}	Si5340/41	—	120	130	mA
Output Buffer Supply Current	I _{DDOx}	LVPECL Output ³ @ 156.25 MHz	—	22	26	mA
		LVDS Output ³ @ 156.25 MHz	—	15	18	mA
		3.3 V LVCMOS ⁴ output @ 156.25 MHz	—	22	30	mA
		2.5 V LVCMOS ⁴ output @ 156.25 MHz	—	18	23	mA
		1.8 V LVCMOS ⁴ output @ 156.25 MHz	—	12	16	mA
Total Power Dissipation ^{1, 5}	P _d	Si5341	—	880	1150	mW
		Si5340	—	680	875	mW

Note:

- Si5341 test configuration: 7 x 2.5 V LVDS outputs enabled @ 156.25 MHz. Excludes power in termination resistors.
- Si5340 test configuration: 4 x 2.5 V LVDS outputs enabled @ 156.25 MHz. Excludes power in termination resistors.
- Differential outputs terminated into an ac-coupled 100 Ω load.
- LVCMOS outputs measured into a 6-inch 50 W PCB trace with 5 pF load. The LVCMOS outputs were set to OUTx_CMOS_DRV=3, which is the strongest driver setting. Refer to the [Si5341/40 Family Reference Manual](#) for more details on register settings.

Differential Output Test Configuration**LVCMOS Output Test Configuration**

- Detailed power consumption for any configuration can be estimated using ClockBuilderPro when an evaluation board (EVB) is not available. All EVBs support detailed current measurements for any configuration.

Table 5.3. Input Clock Specifications(V_{DD} = 1.8 V ± 5%, V_{DDA} = 3.3 V ± 5%, T_A = -40 to 85 °C)

Parameter	Symbol	Test Condition	Min	Typ	Max	Units
Standard Input Buffer with Differential or Single-Ended - AC-Coupled (IN0/IN0b, IN1/IN1b, IN2/IN2b, FB_IN/FB_INb)						
Input Frequency Range	f _{IN}	Differential	10	—	750	MHz
		All Single-ended Signals (including LVCMOS)	10	—	250	MHz
Input Voltage Swing ¹	V _{IN}	Differential AC-coupled f _{IN} < 250 MHz	100	—	1800	mVpp _{se}
		Differential AC-coupled 250 MHz < f _{IN} < 750 MHz	225	—	1800	mVpp _{se}
		Single-ended AC-coupled f _{IN} < 250 MHz	100	—	3600	mVpp _{se}
Slew Rate ^{2, 3}	SR		400	—	—	V/μs
Input Capacitance	C _{IN}		—	2.4	—	pF
Input Resistance Differential	R _{IN_DIFF}		—	16	—	kΩ
Input Resistance Single-Ended	R _{IN_SE}		—	8	—	kΩ
Pulsed CMOS Input Buffer - DC Coupled (IN0, IN1, IN2)						
Input Frequency	f _{IN}		10	—	250	MHz
Input Voltage	V _{IL}		-0.2	—	0.4	V
	V _{IH}		0.8	—	—	V
Slew Rate ^{2, 3}	SR		400	—	—	V/μs
Minimum Pulse Width	PW	Pulse Input	1.6	—	—	ns
Input Resistance	R _{IN}		—	8	—	kΩ
REFCLK (Applied to XA/XB)						
Input Frequency Range	f _{IN}	Full operating range. Jitter performance may be reduced.	10	—	200	MHz
		Range for best jitter.	48	—	54	MHz
Input Single-ended Voltage Swing	V _{IN_SE}		365	—	2000	mVpp _{se}
Input Differential Voltage Swing	V _{IN_DIFF}		365	—	2500	mVpp _{diff}
Slew Rate ^{2, 3}	SR	Imposed for best jitter performance	400	—	—	V/μs
Input Duty Cycle	DC		40	—	60	%

Parameter	Symbol	Test Condition	Min	Typ	Max	Units
Note:						
1. Voltage swing is specified as single-ended mVpp. 2. Recommended for specified jitter performance. Jitter performance can degrade if the minimum slew rate specification is not met (see the Family Reference Manual). 3. Pulsed CMOS mode is intended primarily for single-ended LVCMOS input clocks < 1 MHz, which must be dc-coupled because they have a duty cycle significantly less than 50%. A typical application example is a low frequency video frame sync pulse. Since the input thresholds (V_{IL} , V_{IH}) of this buffer are non-standard (0.4 and 0.8 V, respectively), refer to the input attenuator circuit for DC-coupled Pulsed LVCMOS in the Family Reference Manual . Otherwise, for standard LVCMOS input clocks, use the Standard AC-Coupled, Single-ended input mode.						

Table 5.4. Control Input Pin Specifications

($V_{DD} = 1.8\text{ V} \pm 5\%$, $V_{DDA} = 3.3\text{ V} \pm 5\%$, $V_{DDIO} = 3.3\text{ V} \pm 5\%$, $1.8\text{ V} \pm 5\%$, $T_A = -40\text{ to }85\text{ }^\circ\text{C}$)

Parameter	Symbol	Test Condition	Min	Typ	Max	Units
Si5341 Control Input Pins (I2C_SEL, IN_SEL[1:0], RSTb, OEb, SYNCb, A1, SCLK, A0/CSb, FINC, FDEC, SDA/SDIO)						
Input Voltage	V_{IL}		—	—	$0.3 \times V_{DDIO}^1$	V
	V_{IH}		$0.7 \times V_{DDIO}^1$	—	—	V
Input Capacitance	C_{IN}		—	2	—	pF
Input Resistance	R_{IN}		—	20	—	k Ω
Minimum Pulse Width	T_{PW}	RSTb, SYNCb, FINC, and FDEC	100	—	—	ns
Frequency Update Rate	F_{UR}	FINC and FDEC	—	—	1	MHz
Si5340 Control Input Pins (I2C_SEL, IN_SEL[1:0], RSTb, OEb, A1, SCLK, A0/CSb, SDA/SDIO)						
Input Voltage	V_{IL}		—	—	$0.3 \times V_{DDIO}^1$	V
	V_{IH}		$0.7 \times V_{DDIO}^1$	—	—	V
Input Capacitance	C_{IN}		—	2	—	pF
Input Resistance	R_{IN}		—	20	—	k Ω
Minimum Pulse Width	T_{PW}	RSTb only	100	—	—	ns
Note:						
1. V_{DDIO} is determined by the IO_VDD_SEL bit. It is selectable as V_{DDA} or V_{DD} . Refer to the Family Reference Manual for more details on register settings.						

Table 5.5. Differential Clock Output Specifications(V_{DD}=1.8 V ± 5%, V_{DDA}= 3.3 V ± 5%, V_{DDO}= 1.8 V ± 5%, 2.5 V ± 5%, or 3.3 V ± 5%, T_A= -40 to 85 °C)

Parameter	Symbol	Test Condition	Min	Typ	Max	Units	
Output Frequency	f _{OUT}	MultiSynth not used	0.0001	—	720	MHz	
			733.33	—	800.00		
			825	—	1028		
		MultiSynth used	0.0001	—	720	MHz	
Duty Cycle	DC	f _{OUT} < 400 MHz	48	—	52	%	
		400 MHz < f _{OUT} < 1028 MHz	45	—	55	%	
Output-Output Skew Using Same MultiSynth	T _{SKS}	Outputs on same MultiSynth (Measured at 712.5 MHz)	—	0	75	ps	
OUT-OUTb Skew	T _{SK_OUT}	Measured from the positive to negative output pins	—	0	50	ps	
Output Voltage Swing ¹	V _{OUT}	LVDS	350	430	510	mVpp_se	
		LVPECL	640	750	900		
Common Mode Voltage ^{1, 2}	V _{CM}	V _{DDO} = 3.3 V	LVDS	1.1	1.2	1.3	V
			LVPECL	1.9	2.0	2.1	
		V _{DDO} = 2.5 V	LVPECL	1.1	1.2	1.3	
			LVDS				
V _{DDO} = 1.8 V	Sub-LVDS	0.8	0.9	1.0			
Rise and Fall Times (20% to 80%)	t _R /t _F		—	100	150	ps	
Differential Output Impedance	Z _O		—	100	—	Ω	
Power Supply Noise Rejection ²	PSRR	10 kHz sinusoidal noise	—	-101	—	dBc	
		100 kHz sinusoidal noise	—	-96	—		
		500 kHz sinusoidal noise	—	-99	—		
		1 MHz sinusoidal noise	—	-97	—		
Output-Output Crosstalk ³	XTALK	Si5341	—	-72	—	dBc	
		Si5340	—	-88	—	dBc	

Parameter	Symbol	Test Condition	Min	Typ	Max	Units
Notes:						
1. Output amplitude and common-mode settings are programmable through register settings and can be stored in NVM. Each output driver can be programmed independently. The maximum LVDS single-ended amplitude can be up to 110 mV higher than the TIA/EIA-644 maximum. Refer to the Family Reference Manual for more suggested output settings. Not all combinations of voltage amplitude and common mode voltages settings are possible.						
						
2. Measured for 156.25 MHz carrier frequency. 100 mVpp sinewave noise added to VDDO = 3.3 V and noise spur amplitude measured.						
3. Measured across two adjacent outputs, both in LVDS mode, with the victim running at 155.52 MHz and the aggressor at 156.25 MHz. Refer to application note, AN862: Optimizing Si534x Jitter Performance in Next Generation Internet Infrastructure Systems, guidance on crosstalk minimization.						

Table 5.6. LVCMOS Clock Output Specifications

($V_{DD} = 1.8\text{ V} \pm 5\%$, $V_{DDA} = 3.3\text{ V} \pm 5\%$, $V_{DDO} = 1.8\text{ V} \pm 5\%$, $2.5\text{ V} \pm 5\%$, or $3.3\text{ V} \pm 5\%$, $T_A = -40$ to $85\text{ }^\circ\text{C}$)

Parameter	Symbol	Test Condition	Min	Typ	Max	Units	
Output Frequency			0.0001	—	250	MHz	
Duty Cycle	DC	$f_{OUT} < 100\text{ MHz}$	48	—	52	%	
		$100\text{ MHz} < f_{OUT} < 250\text{ MHz}$	45	—	55		
Output Voltage High ^{1, 2, 3}	V_{OH}	$V_{DDO} = 3.3\text{ V}$					
		OUTx_CMOS_DRV=1	$I_{OH} = -10\text{ mA}$	$V_{DDO} \times 0.85$	—	—	V
		OUTx_CMOS_DRV=2	$I_{OH} = -12\text{ mA}$		—	—	
		OUTx_CMOS_DRV=3	$I_{OH} = -17\text{ mA}$		—	—	
		$V_{DDO} = 2.5\text{ V}$					
		OUTx_CMOS_DRV=1	$I_{OH} = -6\text{ mA}$	$V_{DDO} \times 0.85$	—	—	V
		OUTx_CMOS_DRV=2	$I_{OH} = -8\text{ mA}$		—	—	
		OUTx_CMOS_DRV=3	$I_{OH} = -11\text{ mA}$		—	—	
		$V_{DDO} = 1.8\text{ V}$					
		OUTx_CMOS_DRV=2	$I_{OH} = -4\text{ mA}$	$V_{DDO} \times 0.85$	—	—	V
OUTx_CMOS_DRV=3	$I_{OH} = -5\text{ mA}$	—	—				

Parameter	Symbol	Test Condition	Min	Typ	Max	Units			
Output Voltage Low ^{1, 2, 3}	V_{OL}	$V_{DDO} = 3.3\text{ V}$					$V_{DDO} \times 0.15$	V	
		OUTx_CMOS_DRV=1	$I_{OL} = 10\text{ mA}$	—	—				
		OUTx_CMOS_DRV=2	$I_{OL} = 12\text{ mA}$	—	—				
				OUTx_CMOS_DRV=3	$I_{OL} = 17\text{ mA}$	—	—		
		$V_{DDO} = 2.5\text{ V}$					$V_{DDO} \times 0.15$	V	
		OUTx_CMOS_DRV=1	$I_{OL} = 6\text{ mA}$	—	—				
		OUTx_CMOS_DRV=2	$I_{OL} = 8\text{ mA}$	—	—				
				OUTx_CMOS_DRV=3	$I_{OL} = 11\text{ mA}$	—	—		
		$V_{DDO} = 1.8\text{ V}$					$V_{DDO} \times 0.15$	V	
		OUTx_CMOS_DRV=2	$I_{OL} = 4\text{ mA}$	—	—				
OUTx_CMOS_DRV=3	$I_{OL} = 5\text{ mA}$	—	—						
LVCMOS Rise and Fall Times ³ (20% to 80%)	tr/tf	$V_{DDO} = 3.3\text{ V}$	—	400	600	ps			
		$V_{DDO} = 2.5\text{ V}$	—	450	600	ps			
		$V_{DDO} = 1.8\text{ V}$	—	550	750	ps			

Notes:

1. Driver strength is a register programmable setting and stored in NVM. Options are OUTx_CMOS_DRV = 1, 2, 3. Refer to the Family Reference Manual for more details on register settings.
2. I_{OL}/I_{OH} is measured at V_{OL}/V_{OH} as shown in the dc test configuration.
3. A series termination resistor (R_s) is recommended to help match the source impedance to a 50 Ω PCB trace. A 5 pF capacitive load is assumed. The LVCMOS outputs were set to OUTx_CMOS_DRV = 3.

DC Test Configuration

AC Test Configuration

Table 5.7. Output Status Pin Specifications(V_{DD} = 1.8 V ± 5%, V_{DDA} = 3.3 V ± 5%, V_{DDIO}/V_{DDS} = 3.3 V +/- 5%, 1.8 V ± 5%, T_A = -40 to 85°C)

Parameter	Symbol	Test Condition	Min	Typ	Max	Units
Si5341/40 Status Output Pins (INTRb, SDA/SDIO)¹						
Output Voltage	V _{OH}	I _{OH} = -2 mA	V _{DDIO} ² x 0.85	—	—	V
	V _{OL}	I _{OL} = 2 mA	—	—	V _{DDIO} ² x 0.15	V
Si5341 Status Output Pins (LOLb)						
Output Voltage	V _{OH}	I _{OH} = -2 mA	V _{DDIO} ² x 0.85	—	—	V
	V _{OL}	I _{OL} = 2 mA	—	—	V _{DDIO} ² x 0.15	V
Si5340 Status Output Pins (LOLb, LOS_XAXBb)						
Output Voltage	V _{OH}	I _{OH} = -2 mA	V _{DDS} x 0.85	—	—	V
	V _{OL}	I _{OL} = 2 mA	—	—	V _{DDS} x 0.15	V
Notes:						
1. The V _{OH} specification does not apply to the open-drain SDA/SDIO output when the serial interface is in I ² C mode or is unused with I2C_SEL pulled high. V _{OL} remains valid in all cases.						
2. V _{DDIO} is determined by the IO_VDD_SEL bit. It is selectable as V _{DDA} or V _{DD} . Refer to the Family Reference Manual for more details on register settings.						

Table 5.8. Performance Characteristics(V_{DD} = 1.8 V ± 5%, V_{DDA} = 3.3 V ± 5%, T_A = -40 to 85 °C)

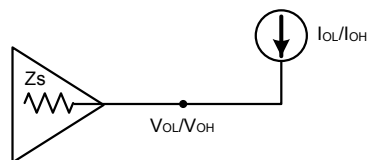
Parameter	Symbol	Test Condition	Min	Typ	Max	Units
PLL Loop Bandwidth	f _{BW}		—	1.0	—	MHz
Initial Start-Up Time	t _{START}	Time from power-up to when the device generates clocks (Input Frequency >48 MHz)	—	30	45	ms
PLL Lock Time ¹	t _{ACQ}	f _{IN} = 19.44 MHz	15	—	150	ms
POR ² to Serial Interface Ready	t _{RDY}		—	—	15	ms

Parameter	Symbol	Test Condition	Min	Typ	Max	Units	
Jitter Generation Locked to External Clock ³	J _{GEN}	Integer Mode ⁴ 12 kHz to 20 MHz	—	140	180	fs rms	
		Fractional/DCO Mode ⁵ 12 kHz to 20 MHz	—	160	210	fs rms	
	J _{PER}	Derived from integrated phase noise	—	110	—	fs rms	
	J _{CC}		—	180	—	fs rms	
	J _{PER}	N = 10,000 cycles Integer or Fractional Mode ^{4, 5} . Measured in the time domain. Performance is limited by the noise floor of the equipment.	—	4710	—	fs pk-pk	
	J _{CC}		—	4000	—	fs pk	
Jitter Generation Locked to External XTAL	XTAL Frequency = 48 MHz						
	J _{GEN}	Integer Mode ⁴ 12 kHz to 20 MHz	—	90	140	fs rms	
		Fractional/DCO Mode ⁵ 12 kHz to 20 MHz	—	115	170	fs rms	
	J _{PER}	Derived from integrated phase noise	—	110	—	fs rms	
	J _{CC}		—	180	—	fs rms	
	J _{PER}	N = 10, 000 cycles Integer or Fractional Mode. ^{4, 5} Measured in the time domain. Performance is limited by the noise floor of the equipment.	—	5080	—	fs pk-pk	
	J _{CC}		—	4340	—	fs pk	
	XTAL Frequency = 25 MHz						
	J _{GEN}	Integer Mode ⁴ 12 kHz to 20 MHz			115	140	fs rms
		Fractional Mode ⁵ 12 kHz to 20 MHz			140	190	fs rms

Notes:

1. PLL lock time is measured by first letting the PLL lock, then turning off the input clock, and then turning on the input clock. The time from the first edge of the input clock being re-applied until LOL de-asserts is the PLL lock time.
2. Measured as time from valid V_{DD} and V_{DD33} rails (90% of their value) to when the serial interface is ready to respond to commands. Measured in SPI 4-wire mode, with SCLK @ 10 MHz.
3. Jitter generation test conditions f_{IN} = 100 MHz, f_{OUT} = 156.25 MHz LVPECL.
4. Integer mode assumes that the output dividers (Nn/Nd) are configured with an integer value.
5. Fractional and DCO modes assume that the output dividers (Nn/Nd) are configured with a fractional value and the feedback divider is integer.

Table 5.9. I²C Timing Specifications (SCL,SDA)

Parameter	Symbol	Test Condition	Standard Mode		Fast Mode		Units
			100 kbps		400 kbps		
			Min	Max	Min	Max	
SCL Clock Frequency	f_{SCL}		—	100	—	400	kHz
Hold Time (Repeated) START Condition	$t_{HD:STA}$		4.0	—	0.6	—	μ s
Low Period of the SCL Clock	t_{LOW}		4.7	—	1.3	—	μ s
HIGH Period of the SCL Clock	t_{HIGH}		4.0	—	0.6	—	μ s
Set-up Time for a Repeated START Condition	$t_{SU:STA}$		4.7	—	0.6	—	μ s
Data Hold Time	$t_{HD:DAT}$		100	—	100	—	ns
Data Set-up Time	$t_{SU:DAT}$		250	—	100	—	ns
Rise Time of Both SDA and SCL Signals	t_r		—	1000	20	300	ns
Fall Time of Both SDA and SCL Signals	t_f		—	300	—	300	ns
Set-up Time for STOP Condition	$t_{SU:STO}$		4.0	—	0.6	—	μ s
Bus Free Time between a STOP and START Condition	t_{BUF}		4.7	—	1.3	—	μ s
Data Valid Time	$t_{VD:DAT}$		—	3.45	—	0.9	μ s
Data Valid Acknowledge Time	$t_{VD:ACK}$		—	3.45	—	0.9	μ s



Figure 5.1. I²C Serial Port Timing Standard and Fast Modes

Table 5.10. SPI Timing Specifications (4-Wire)

($V_{DD}=1.8\text{ V} \pm 5\%$, $V_{DDA}=3.3\text{ V} \pm 5\%$, $T_A=-40\text{ to }85\text{ }^\circ\text{C}$)

Parameter	Symbol	Min	Typ	Max	Units
SCLK Frequency	f_{SPI}	—	—	20	MHz
SCLK Duty Cycle	T_{DC}	40	—	60	%
SCLK Period	T_{C}	50	—	—	ns
Delay Time, SCLK Fall to SDO Active	T_{D1}	—	12.5	18	ns
Delay Time, SCLK Fall to SDO	T_{D2}	—	10	15	ns
Delay Time, CSb Rise to SDO Tri-State	T_{D3}	—	10	15	ns
Setup Time, CSb to SCLK	T_{SU1}	5	—	—	ns
Hold Time, SCLK Fall to CSb	T_{H1}	5	—	—	ns
Setup Time, SDI to SCLK Rise	T_{SU2}	5	—	—	ns
Hold Time, SDI to SCLK Rise	T_{H2}	5	—	—	ns
Delay Time Between Chip Selects (CSb) ¹	T_{CS}	2	—	—	T_{C}

Note:

1. The minimum time is based on 20 MHz SPI clock (50 ns). So the minimum wait time between two frames should be $2 \cdot 50\text{ ns} = 100\text{ ns}$.

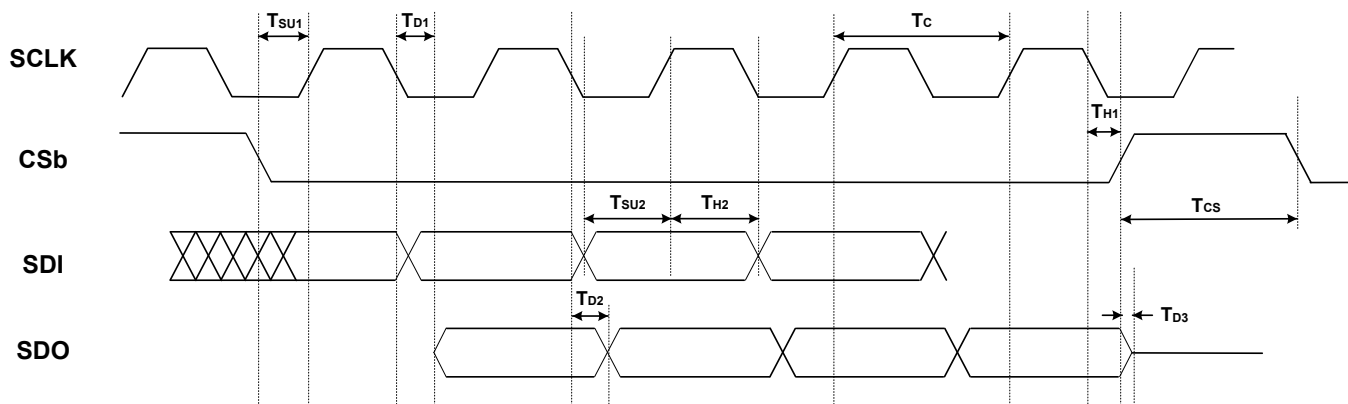

Figure 5.2. 4-Wire SPI Serial Interface Timing

Table 5.11. SPI Timing Specifications (3-Wire)(V_{DD}=1.8 V ± 5%, V_{DDA}= 3.3 V ± 5%, T_A= -40 to 85 °C)

Parameter	Symbol	Min	Typ	Max	Units
SCLK Frequency	f _{SPI}	—	—	20	MHz
SCLK Duty Cycle	T _{DC}	40	—	60	%
SCLK Period	T _C	50	—	—	ns
Delay Time, SCLK Fall to SDO Turn-on	T _{D1}	—	12.5	20	ns
Delay Time, SCLK Fall to SDO Next-bit	T _{D2}	—	10	15	ns
Delay Time, CSb Rise to SDO Tri-State	T _{D3}	—	10	15	ns
Setup Time, CSb to SCLK	T _{SU1}	5	—	—	ns
Hold Time, SCLK Fall to CSb	T _{H1}	5	—	—	ns
Setup Time, SDI to SCLK Rise	T _{SU2}	5	—	—	ns
Hold Time, SDI to SCLK Rise	T _{H2}	5	—	—	ns
Delay Time Between Chip Selects (CSb) ¹	T _{CS}	2	—	—	T _C

Note:

- The minimum time is based on 20 MHz SPI clock (50 ns). So the minimum wait time between two frames should be 2*50 ns = 100 ns.

**Figure 5.3. 3-Wire SPI Serial Interface Timing**

Table 5.12. Crystal Specifications

Parameter	Symbol	Test Condition	Min	Typ	Max	Units
Crystal Frequency Range	f_{XTAL}	Full operating range. Jitter performance may be reduced.	24.97	—	54.06	MHz
		Range for best jitter.	48	—	54	MHz
Load Capacitance	C_L		—	8	—	pF
Crystal Drive Level	d_L		—	—	200	μ W
Equivalent Series Resistance	r_{ESR}	Refer to the Si5341/40 Family Reference Manual to determine ESR and shunt capacitance.				
Shunt Capacitance	C_O					

Note:

1. Refer to the [Si534x/8x Recommended Crystal, TCXO and OCXOs Reference Manual](#) for recommended 48 to 54 MHz crystals. The Si5341/40 are designed to work with crystals that meet these specifications.

Table 5.13. Thermal Characteristics

Parameter	Symbol	Test Condition ¹	Value	Units
Si5341 - 64QFN				
Thermal Resistance Junction to Ambient	Θ_{JA}	Still Air	22	$^{\circ}$ C/W
		Air Flow 1 m/s	19.4	
		Air Flow 2 m/s	18.3	
Thermal Resistance Junction to Case	Θ_{JC}		9.5	
Thermal Resistance Junction to Board	Θ_{JB}		9.4	
	Ψ_{JB}		9.3	
Thermal Resistance Junction to Top Center	Ψ_{JT}		0.2	
Si5340 - 44QFN				
Thermal Resistance Junction to Ambient	Θ_{JA}	Still Air	22.3	$^{\circ}$ C/W
		Air Flow 1 m/s	19.4	
		Air Flow 2 m/s	18.4	
Thermal Resistance Junction to Case	Θ_{JC}		10.9	
Thermal Resistance Junction to Board	Θ_{JB}		9.3	
	Ψ_{JB}		9.2	
Thermal Resistance Junction to Top Center	Ψ_{JT}		0.23	

Note:

1. Based on PCB Dimension: 3" x 4.5", PCB Land/Via under GND pad: 36, Number of Cu Layers: 4

Table 5.14. Absolute Maximum Ratings^{1, 2, 3, 4, 5}

Parameter	Symbol	Test Condition	Value	Units
Storage Temperature Range	T _{STG}		-55 to +150	°C
DC Supply Voltage	V _{DD}		-0.5 to 3.8	V
	V _{DDA}		-0.5 to 3.8	V
	V _{DDO}		-0.5 to 3.8	V
Input Voltage Range	V _{I1}	IN0-IN2, FB_IN	-1.0 to 3.8	V
	V _{I2}	IN_SEL[1:0], RSTb, OEb, SYNCb, I2C_SEL, SDI, SCLK, A0/CSb, A1, SDA/SDIO, FINC/ FDEC	-0.5 to 3.8	V
	V _{I3}	XA/XB	-0.5 to 2.7	V
Latch-up Tolerance	LU		JESD78 Compliant	
ESD Tolerance	HBM	100 pF, 1.5 kΩ	2.0	kV
Maximum Junction Temperature in Operation	T _{JCT}		125	°C
Soldering Temperature (Pb-free profile) ⁵	T _{PEAK}		260	°C
Soldering Temperature Time at T _{PEAK} (Pb-free profile) ⁵	T _P		20 to 40	sec
Notes:				
1. Permanent device damage may occur if the absolute maximum ratings are exceeded. Functional operation should be restricted to the conditions as specified in the operational sections of this data sheet. Exposure to absolute maximum rating conditions for extended periods may affect device reliability.				
2. 64-QFN and 44-QFN packages are RoHS-6 compliant.				
3. Moisture sensitivity level is MSL2. For more packaging information, go to the Skyworks RoHS information page .				
4. The minimum voltage at these pins can be as low as -1.0 V when an AC input signal of 10 MHz or greater is applied. See Table 5.3 Input Clock Specifications on page 19 spec for single-ended AC-coupled f _{IN} < 250 MHz.				
5. The device is compliant with JEDEC J-STD-020.				

6. Typical Application Schematic



One Si5341 replaces:
 3x crystal oscillators (XO)
 2x buffers
 1x Clock Generator
 2x level translators



Figure 6.1. Using the Si5341 to Replace a Traditional Clock Tree

7. Detailed Block Diagrams



Figure 7.1. Si5341 Block Diagram



Figure 7.2. Si5340 Detailed Block Diagram

8. Typical Operating Characteristics



Figure 8.1. Integer Mode--48 MHz Crystal, 625 MHz Output (2.5 V LVDS)

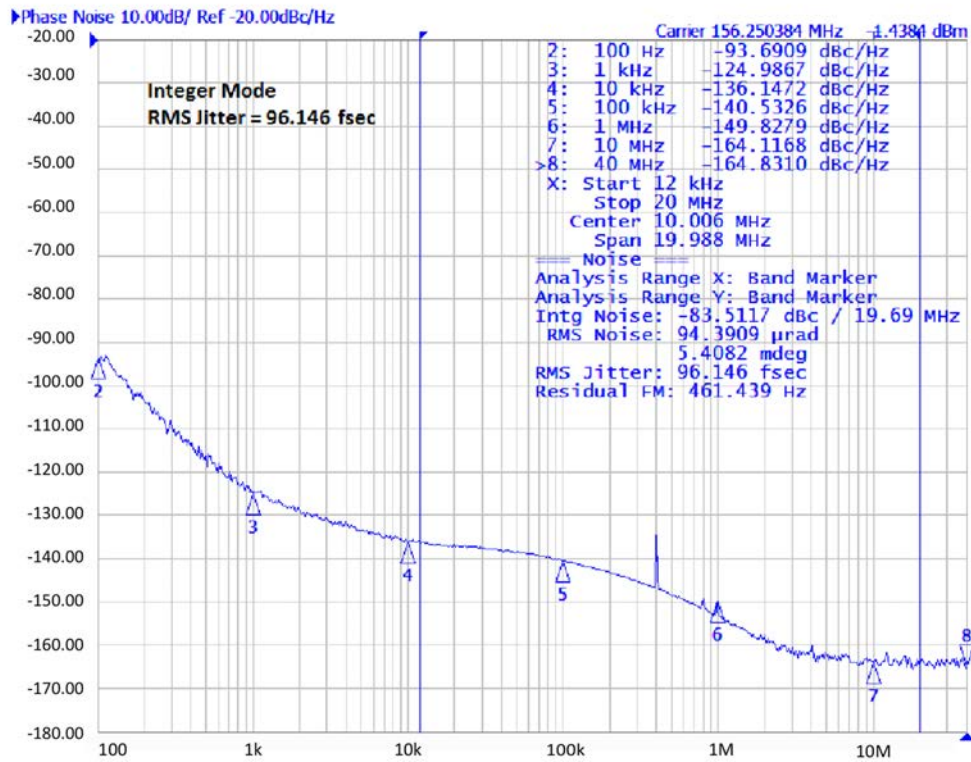

Figure 8.2. Integer Mode--48 MHz Crystal, 156.25 MHz Output (2.5 V LVDS)



Figure 8.3. Fractional Mode--48 MHz Crystal, 155.52 MHz Output (2.5 V LVDS)

9. Pin Descriptions

Si 5341 64QFN
Top View



Si 5340 44QFN
Top View



Table 9.1. Pin Descriptions

Pin Name	Pin Number		Pin Type ¹	Function
	Si5341	Si5340		
Inputs				
XA	8	5	I	Crystal and External Clock Input. These pins are used to connect an external crystal or an external clock. See 3.3.1 XA/XB Clock and Crystal Input and Figure 3.2 XAXB External Crystal and Clock Connections on page 8 for connection information. If IN_SEL[1:0] = 11b, then the XAXB input is selected. If the XAXB input is not used and powered down, then both inputs can be left unconnected. ClockBuilder Pro will power down an input that is set as "Unused".
XB	9	6	I	
X1	7	4	I	XTAL Shield. Connect these pins directly to the XTAL ground pins. X1, X2, and the XTAL ground pins must not be connected to the PCB ground plane. DO NOT GROUND THE CRYSTAL GROUND PINS. Refer to the Si5341/40 Family Reference Manual for layout guidelines. These pins should be left disconnected when connecting XA/XB pins to an external reference clock.
X2	10	7	I	
IN0	63	43	I	Clock Inputs. These pins accept both differential and single-ended clock signals. Refer 3.3.2 Input Clocks (IN0, IN1, IN2) for input termination options. These pins are high-impedance and must be terminated externally. If both the INx and INx (with overstrike) inputs are un-used and powered down, then both inputs can be left floating. ClockBuilder Pro will power down an input that is set as "Unused".
IN0b	64	44	I	
IN1	1	1	I	
IN1b	2	2	I	
IN2	14	10	I	
IN2b	15	11	I	
FB_IN	61	41	I	External Feedback Input. These pins are used as the external feedback input (FB_IN/FB_INb) for the optional zero delay mode. See 3.5.11 Zero Delay Mode for details on the optional zero delay mode. If FB_IN and FB_IN (with overstrike) are un-used and powered down, then both inputs can be left floating. ClockBuilder Pro will power down an input that is set as "Unused".
FB_INb	62	42	I	

Pin Name	Pin Number		Pin Type ¹	Function
	Si5341	Si5340		
Outputs				
OUT0	24	20	O	Output Clocks. These output clocks support a programmable signal amplitude when configured as a differential output. Desired output signal format is configurable using register control. Termination recommendations are provided in 3.5.2 Differential Output Terminations and 3.5.4 LVCMOS Output Terminations . Unused outputs should be left unconnected.
OUT0b	23	19	O	
OUT1	28	25	O	
OUT1b	27	24	O	
OUT2	31	31	O	
OUT2b	30	30	O	
OUT3	35	36	O	
OUT3b	34	35	O	
OUT4	38	—	O	
OUT4b	37	—	O	
OUT5	42	—	O	
OUT5b	41	—	O	
OUT6	45	—	O	
OUT6b	44	—	O	
OUT7	51	—	O	
OUT7b	50	—	O	
OUT8	54	—	O	
OUT8b	53	—	O	
OUT9	59	—	O	
OUT9b	58	—	O	
Serial Interface				
I2C_SEL	39	38	I	I²C Select. ² This pin selects the serial interface mode as I ² C (I2C_SEL = 1) or SPI (I2C_SEL = 0). This pin is internally pulled up by a ~ 20 kΩ resistor to the voltage selected by the IO_VDD_SEL register bit.
SDA/SDIO	18	13	I/O	Serial Data Interface. ² This is the bidirectional data pin (SDA) for the I ² C mode, or the bidirectional data pin (SDIO) in the 3-wire SPI mode, or the input data pin (SDI) in 4-wire SPI mode. When in I ² C mode, this pin must be pulled-up using an external resistor of at least 1 kΩ. No pull-up resistor is needed when in SPI mode.
A1/SDO	17	15	I/O	Address Select 1/Serial Data Output. ² In I ² C mode, this pin functions as the A1 address input pin and does not have an internal pull up or pull down resistor. In 4-wire SPI mode this is the serial data output (SDO) pin (SDO) pin and drives high to the voltage selected by the IO_VDD_SEL pin.
SCLK	16	14	I	Serial Clock Input. ² This pin functions as the serial clock input for both I ² C and SPI modes. This pin is internally pulled up by a ~20 kΩ resistor to the voltage selected by the IO_VDD_SEL register bit. In I ² C mode this pin should have an external pull up of at least 1 kΩ. No pull-up resistor is needed when in SPI mode.

Pin Name	Pin Number		Pin Type ¹	Function
	Si5341	Si5340		
A0/CSb	19	16	I	Address Select 0/Chip Select. ² This pin functions as the hardware controlled address A0 in I ² C mode. In SPI mode, this pin functions as the chip select input (active low). This pin is internally pulled up by a ~20 kΩ resistor to the voltage selected by the IO_VDD_SEL register bit.
Control/Status				
INTRb	12	33	O	Interrupt. ² This pin is asserted low when a change in device status has occurred. This interrupt has a push pull output and should be left unconnected when not in use.
RSTb	6	17	I	Device Reset. ² Active low input that performs power-on reset (POR) of the device. Resets all internal logic to a known state and forces the device registers to their default values. Clock outputs are disabled during reset. This pin is internally pulled up with a ~20 kΩ resistor to the voltage selected by the IO_VDD_SEL bit.
OEb	11	12	I	Output Enable. ² This pin disables all outputs when held high. This pin is internally pulled low and can be left unconnected when not in use.
LOLb	47	—	O	Loss Of Lock. ² This output pin indicates when the DSPLL™ is locked (high) or out-of-lock (low). An external pull up or pull down is not needed.
	—	27	O	Loss Of Lock. ³ This output pin indicates when the DSPLL is locked (high) or out-of-lock (low). An external pull up or pull down is not needed.
LOS_XAXBb	—	28	O	Loss Of Signal. ³ This output pin indicates a loss of signal at the XA/XB pins.
SYNCb	5	—	I	Output Clock Synchronization. ² An active low signal on this pin resets the output dividers for the purpose of re-aligning the output clocks. For a tighter alignment of the clocks, a soft reset should be applied. This pin is internally pulled up with a ~20 kΩ resistor to the voltage selected by the IO_VDD_SEL bit and can be left unconnected when not in use.
FDEC	25	—	I	Frequency Decrement Pin. ² This pin is used to step-down the output frequency of a selected output. The affected output driver and its frequency change step size is register configurable. This pin is internally pulled low with a ~20 kΩ resistor and can be left unconnected when not in use.
FINC	48	—	I	Frequency Increment Pin. ² This pin is used to step-up the output frequency of a selected output. The affected output and its frequency change step size is register configurable. This pin is internally pulled low with a ~20 kΩ resistor and can be left unconnected when not in use.
IN_SEL0	3	3	I	Input Reference Select. ² The IN_SEL[1:0] pins are used in the manual pin controlled mode to select the active clock input. These pins are internally pulled up with a ~20 kΩ resistor to the voltage selected by the IO_VDD_SEL bit and can be left unconnected when not in use.
IN_SEL1	4	37	I	

Pin Name	Pin Number		Pin Type ¹	Function
	Si5341	Si5340		
RSVD	20	—	—	Reserved. These pins are connected to the die. Leave disconnected.
	21	—	—	
	55	—	—	
	56	—	—	
NC	—	22	—	No Connect. These pins are not connected to the die. Leave disconnected.
Power				
VDD	32	21	P	Core Supply Voltage. The device core operates from a 1.8 V supply. A 1.0 µf bypass capacitor is recommended.
	46	32		
	60	39		
	—	40		
VDDA	13	8	P	Core Supply Voltage 3.3 V. This core supply pin requires a 3.3 V power source. A 1.0 µf bypass capacitor is recommended.
	—	9	P	
VDDS	—	26	P	Status Output Voltage. The voltage on this pin determines the V _{OL} /V _{OH} on LOLb and LOS_XAXBb status output pins. A 0.1 µf to 1.0 µf bypass capacitor is recommended.
VDDO0	22	18	P	Output Clock Supply Voltage 0–9. Supply voltage (3.3 V, 2.5 V, 1.8 V) for OUTx, OUTx outputs. See the Si5341/40 Family Reference Manual for power supply filtering recommendations. Leave VDDO pins of unused output drivers unconnected. An alternate option is to connect the VDDO pin to a power supply and disable the output driver to minimize current consumption.
VDDO1	26	23	P	
VDDO2	29	29	P	
VDDO3	33	34	P	
VDDO4	36	—	P	
VDDO5	40	—	P	
VDDO6	43	—	P	
VDDO7	49	—	P	
VDDO8	52	—	P	
VDDO9	57	—	P	
GND PAD			P	Ground Pad This pad provides electrical and thermal connection to ground and must be connected for proper operation. Use as many vias as practical and keep the via length to an internal ground plan as short as possible.

Note:

1. I = Input, O = Output, P = Power.
2. The IO_VDD_SEL control bit (0x0943 bit 0) selects 3.3 V or 1.8 V operation.
3. The voltage on the VDDS pin(s) determines 3.3 V or 1.8 V operation.
4. Refer to the [Family Reference Manual](#) for more information on register setting names.
5. All status pins except I2C and SPI are push-pull.

10. Package Outlines

10.1 Si5341 9x9 mm 64-QFN Package Diagram

The figure below illustrates the package details for the Si5341. The table below lists the values for the dimensions shown in the illustration.



Figure 10.1. 64-Pin Quad Flat No-Lead (QFN)

Table 10.1. Package Dimensions

Dimension	Min	Nom	Max
A	0.80	0.85	0.90
A1	0.00	0.02	0.05
b	0.18	0.25	0.30
D	9.00 BSC		
D2	5.10	5.20	5.30
e	0.50 BSC		
E	9.00 BSC		
E2	5.10	5.20	5.30
L	0.30	0.40	0.50
aaa	—	—	0.10
bbb	—	—	0.10
ccc	—	—	0.08
ddd	—	—	0.10
eee	—	—	0.05

Notes:

1. All dimensions shown are in millimeters (mm) unless otherwise noted.
2. Dimensioning and Tolerancing per ANSI Y14.5M-1994.
3. This drawing conforms to the JEDEC Solid State Outline MO-220.
4. Recommended card reflow profile is per the JEDEC/IPC J-STD-020 specification for Small Body Components.

10.2 Si5340 7x7 mm 44-QFN Package Diagram

The figure below illustrates the package details for the Si5340. The table below lists the values for the dimensions shown in the illustration.



Figure 10.2. 44-Pin Quad Flat No-Lead (QFN)

Table 10.2. Package Dimensions

Dimension	Min	Nom	Max
A	0.80	0.85	0.90
A1	0.00	0.02	0.05
b	0.18	0.25	0.30
D	7.00 BSC		
D2	5.10	5.20	5.30
e	0.50 BSC		
E	7.00 BSC		
E2	5.10	5.20	5.30
L	0.30	0.40	0.50
aaa	—	—	0.10
bbb	—	—	0.10
ccc	—	—	0.08
ddd	—	—	0.10

Notes:

1. All dimensions shown are in millimeters (mm) unless otherwise noted.
2. Dimensioning and Tolerancing per ANSI Y14.5M-1994.
3. This drawing conforms to the JEDEC Solid State Outline MO-220.
4. Recommended card reflow profile is per the JEDEC/IPC J-STD-020 specification for Small Body Components.

11. PCB Land Pattern

The figure below illustrates the PCB land pattern details for the devices. The table below lists the values for the dimensions shown in the illustration.



Figure 11.1. PCB Land Pattern

Table 11.1. PCB Land Pattern Dimensions

Dimension	Si5341 (Max)	Si5340 (Max)
C1	8.90	6.90
C2	8.90	6.90
E	0.50	0.50
X1	0.30	0.30
Y1	0.85	0.85
X2	5.30	5.30
Y2	5.30	5.30

Notes:**General**

1. All dimensions shown are in millimeters (mm) unless otherwise noted.
2. This Land Pattern Design is based on the IPC-7351 guidelines.
3. All dimensions shown are at Maximum Material Condition (MMC). Least Material Condition is calculated based on a fabrication Allowance of 0.05 mm.

Solder Mask Design

1. All metal pads are to be non-solder mask defined (NSMD). Clearance between the solder mask and the metal pad is to be 60 μm minimum, all the way around the pad.

Stencil Design

1. A stainless steel, laser-cut and electro-polished stencil with trapezoidal walls should be used to assure good solder paste release.
2. The stencil thickness should be 0.125 mm (5 mils).
3. The ratio of stencil aperture to land pad size should be 1:1 for all perimeter pads.
4. A 3 \times 3 array of 1.25 mm square openings on 1.80 mm pitch should be used for the center ground pad.

Card Assembly

1. A No-Clean, Type-3 solder paste is recommended.
2. The recommended card reflow profile is per the JEDEC/IPC J-STD-020 specification for Small Body Components.

12. Top Marking



Figure 12.1. Si5341-40 Top Markings

Table 12.1. Si5341-40 Top Marking Explanation

Line	Characters	Description
1	Si5341g- Si5340g-	Base part number and Device Grade for Low Jitter, Any-Frequency, 10-output Clock Generator. Si5341: 10-output, 64-QFN Si5340: 4-output, 44-QFN g = Device Grade (A, B, C, D). See 2. Ordering Guide for more information. – = Dash character.
2	Rxxxxx-GM	R = Product revision. (See ordering guide for current revision). xxxxx = Customer specific NVM sequence number. Optional NVM code assigned for custom, factory pre-programmed devices. Characters are not included for standard, factory default configured devices. See Ordering Guide for more information. –GM = Package (QFN) and temperature range (–40 to +85 °C)
3	YYWWTTTTTT	YYWW = Characters correspond to the year (YY) and work week (WW) of package assembly. TTTTTT = Manufacturing trace code.
4	Circle w/ 1.6 mm (64-QFN) or 1.4 mm (44-QFN) diameter	Pin 1 indicator; left-justified
	e4	Pb-free symbol; Center-Justified
	TW	TW = Taiwan; Country of Origin (ISO Abbreviation)

13. Device Errata

Please log in or register at <http://www.skyworksinc.com> to access the device errata document.

14. Revision History

Revision 1.1

July, 2020

- Updated [Figure 3.2 XAXB External Crystal and Clock Connections on page 8](#).
- Updated [Figure 3.4 Supported Differential Output Terminations on page 10](#).
- Removed "Output Delay Control (t_0 – t_4)" section.
- Added [Zero Delay Mode](#).
- Removed section on Sync Pin (Synchronizing R Dividers).
- Updated [4. Register Map](#).
- Removed Addressing Scheme section.
- Removed High-Level Register Map section.
- Updated [Table 5.3 Input Clock Specifications on page 19](#).
 - Updated Input Capacitance specification typical value.
 - Updated the Notes section.
 - Min input frequency updated to 10 MHz.
- Updated [Table 5.5 Differential Clock Output Specifications on page 21](#).
 - Updated Output-Output Skew Using Same Multisynth specification typical and max values.
- Updated [Table 5.6 LVCMOS Clock Output Specifications on page 22](#).
 - Removed Output-to-Output Skew specification.
- Updated [Table 5.8 Performance Characteristics on page 24](#).
 - Removed Output Delay Adjustment specification.
 - Min VCO Frequency Range (FVCO) updated to 13.2 GHz.
- Updated [Table 5.10 on page 28 SPI Timing Specifications \(4-Wire\)](#).
 - Updated T_{H1} description for Hold Time to SCLK Fall to CSb.
 - Added Note for Delay Time Between Chip Selects (CSb).
- Updated [Figure 5.2 4-Wire SPI Serial Interface Timing on page 28](#).
- Updated [Table 5.11 on page 29 SPI Timing Specifications \(3-Wire\)](#).
 - Updated T_{H1} description for Hold Time to SCLK Fall to CSb.
 - Added Note for Delay Time Between Chip Selects (CSb).
- Updated [Figure 5.3 3-Wire SPI Serial Interface Timing on page 29](#).
- Updated [Table 5.13 Thermal Characteristics on page 30](#).
 - Updated PCB size from mm to inches.
- Updated [Figure 6.1 Using the Si5341 to Replace a Traditional Clock Tree on page 32](#).
 - Removed output delay adjustment features.
- Updated [7. Detailed Block Diagrams](#).
 - Removed Δt blocks from block diagrams.
- Updated [Table 10.1 Package Dimensions on page 42](#) for 64-Pin QFN.
 - Max dimension "aaa" updated to 0.10 mm.
- Updated [Table 10.2 Package Dimensions on page 43](#) for 44-Pin QFN.
 - Max dimension "aaa" updated to 0.10 mm.

Revision 1.0

July, 2016

- Initial release. (See "[AN1006: Differences between Si534x/8x Revision B and Revision D Silicon](#)" for a list of changes from Rev B to Rev D.)



SKYWORKS®

ClockBuilder Pro

Customize Skyworks clock generators, jitter attenuators and network synchronizers with a single tool. With CBPro you can control evaluation boards, access documentation, request a custom part number, export for in-system programming and more!

www.skyworksinc.com/CBPro



Portfolio

www.skyworksinc.com/ia/timing



SW/HW

www.skyworksinc.com/CBPro



Quality

www.skyworksinc.com/quality



Support & Resources

www.skyworksinc.com/support

Copyright © 2021 Skyworks Solutions, Inc. All Rights Reserved.

Information in this document is provided in connection with Skyworks Solutions, Inc. ("Skyworks") products or services. These materials, including the information contained herein, are provided by Skyworks as a service to its customers and may be used for informational purposes only by the customer. Skyworks assumes no responsibility for errors or omissions in these materials or the information contained herein. Skyworks may change its documentation, products, services, specifications or product descriptions at any time, without notice. Skyworks makes no commitment to update the materials or information and shall have no responsibility whatsoever for conflicts, incompatibilities, or other difficulties arising from any future changes.

No license, whether express, implied, by estoppel or otherwise, is granted to any intellectual property rights by this document. Skyworks assumes no liability for any materials, products or information provided hereunder, including the sale, distribution, reproduction or use of Skyworks products, information or materials, except as may be provided in Skyworks' Terms and Conditions of Sale.



THE MATERIALS, PRODUCTS AND INFORMATION ARE PROVIDED "AS IS" WITHOUT WARRANTY OF ANY KIND, WHETHER EXPRESS, IMPLIED, STATUTORY, OR OTHERWISE, INCLUDING FITNESS FOR A PARTICULAR PURPOSE OR USE, MERCHANTABILITY, PERFORMANCE, QUALITY OR NON-INFRINGEMENT OF ANY INTELLECTUAL PROPERTY RIGHT; ALL SUCH WARRANTIES ARE HEREBY EXPRESSLY DISCLAIMED. SKYWOKS DOES NOT WARRANT THE ACCURACY OR COMPLETENESS OF THE INFORMATION, TEXT, GRAPHICS OR OTHER ITEMS CONTAINED WITHIN THESE MATERIALS. SKYWOKS SHALL NOT BE LIABLE FOR ANY DAMAGES, INCLUDING BUT NOT LIMITED TO ANY SPECIAL, INDIRECT, INCIDENTAL, STATUTORY, OR CONSEQUENTIAL DAMAGES, INCLUDING WITHOUT LIMITATION, LOST REVENUES OR LOST PROFITS THAT MAY RESULT FROM THE USE OF THE MATERIALS OR INFORMATION, WHETHER OR NOT THE RECIPIENT OF MATERIALS HAS BEEN ADVISED OF THE POSSIBILITY OF SUCH DAMAGE.

Skyworks products are not intended for use in medical, lifesaving or life-sustaining applications, or other equipment in which the failure of the Skyworks products could lead to personal injury, death, physical or environmental damage. Skyworks customers using or selling Skyworks products for use in such applications do so at their own risk and agree to fully indemnify Skyworks for any damages resulting from such improper use or sale.

Customers are responsible for their products and applications using Skyworks products, which may deviate from published specifications as a result of design defects, errors, or operation of products outside of published parameters or design specifications. Customers should include design and operating safeguards to minimize these and other risks. Skyworks assumes no liability for applications assistance, customer product design, or damage to any equipment resulting from the use of Skyworks products outside of Skyworks' published specifications or parameters.



Skyworks, the Skyworks symbol, Sky5®, SkyOne®, SkyBlue™, Skyworks Green™, Clockbuilder®, DSPLL®, ISOModem®, ProSLIC®, and SiPHY® are trademarks or registered trademarks of Skyworks Solutions, Inc. or its subsidiaries in the United States and other countries. Third-party brands and names are for identification purposes only and are the property of their respective owners. Additional information, including relevant terms and conditions, posted at www.skyworksinc.com, are incorporated by reference.

Skyworks Solutions, Inc. | Nasdaq: SWKS | sales@skyworksinc.com | www.skyworksinc.com

USA: 781-376-3000 | Asia: 886-2-2735 0399 | Europe: 33 (0)1 43548540 |    

Looking for pricing, stock, or lifecycle information?

Click below to explore more details on WIN SOURCE:

-  [View SI5341B-D10789-GMR on WIN SOURCE](#)
-  [Skyworks Solutions Inc. Information](#)

Optimize Your Supply Chain with WIN SOURCE Solutions

-  Global Sourcing Solution
-  Obsolete Management
-  Cost Control Management
-  Shortage Management
-  Alternative Solution
-  Excess Inventory Management