



**THE DATASHEET OF
SI5350A-B04499-GTR**





SKYWORKS®

Si5350A-B

FACTORY-PROGRAMMABLE ANY-FREQUENCY CMOS CLOCK GENERATOR

Features

- <https://www.skyworksinc.com/Products/Timing/CMOS-Clock-Generators>
- Generates up to 8 non-integer-related frequencies from 2.5 kHz to 200 MHz
- Exact frequency synthesis at each output (0 ppm error)
- Glitchless frequency changes
- Low output period jitter: < 70 ps pp, typ
- Configurable Spread Spectrum selectable at each output
- User-configurable control pins:
 - Output Enable (OEB_0/1/2)
 - Power Down (PDN)
 - Frequency Select (FS_0/1)
 - Spread Spectrum Enable (SSEN)
- Supports static phase offset
- Rise/fall time control
- Operates from a low-cost, fixed frequency crystal: 25 or 27 MHz
- Separate voltage supply pins provide level translation:
 - Core VDD: 1.8 V, 2.5 V or 3.3 V
 - Output VDDO: 1.8 V, 2.5 V or 3.3 V
- Excellent PSRR eliminates external power supply filtering
- Very low power consumption (25 mA core, typ)
- Available in 3 packages types:
 - 10-MSOP: 3 outputs
 - 16-QFN (3x3 mm): 4 output
 - 20-QFN (4x4 mm): 8 output
- PCIE Gen 1 compatible
- Supports HCSL jitter compatible swing

Applications

- HDTV, DVD/Blu-ray, set-top box
- Audio/video equipment, gaming
- Printers, scanners, projectors
- Handheld instrumentation
- Residential gateways
- Networking/communication
- Servers, storage
- XO replacement

Description

The Si5350A is a highly-flexible, user-definable custom clock generator that is ideally suited for replacing crystals and crystal oscillators in cost-sensitive applications. Based on a PLL + high resolution fractional divider MultiSynth™ architecture, the Si5350A can generate any frequency up to 200 MHz on each of its outputs with 0 ppm error. Spread spectrum is selectable (on/off) on any of the outputs. Custom Si5350A configurations can be created using [ClockBuilder Pro](#).



Functional Block Diagrams

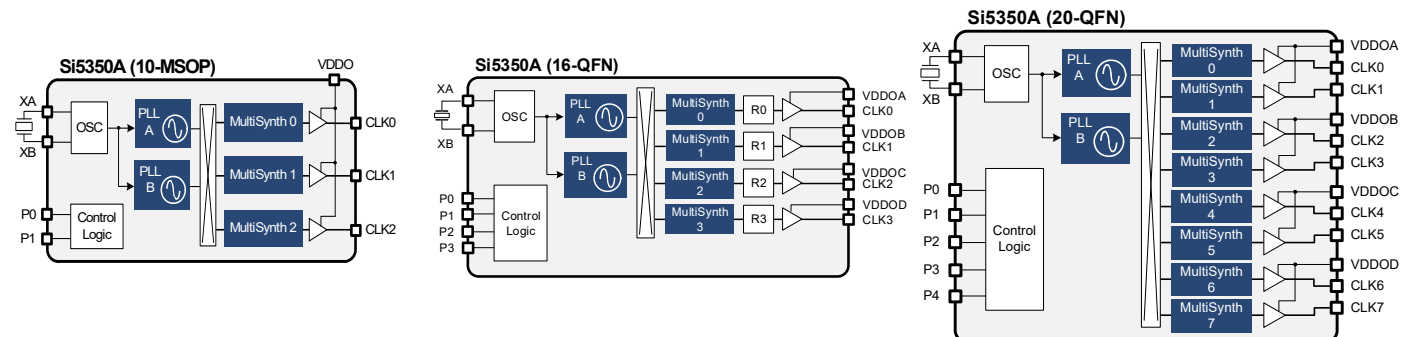

Si5350A-B

1. Ordering Guide

Table 1. Complete Si5350/51 Clock Generator Family

Part Number	I ² C or Pin	Frequency Reference	Programmed?	Outputs	Data Sheet
Si5351A-B-GT	I ² C	XTAL only	Blank	3	Si5351A/B/C-B
Si5351A-B-GM1	I ² C	XTAL only	Blank	4	Si5351A/B/C-B
Si5351B-B-GM1	I ² C	XTAL and/or Voltage	Blank	4	Si5351A/B/C-B
Si5351C-B-GM1	I ² C	XTAL and/or CLKIN	Blank	4	Si5351A/B/C-B
Si5351A-B-GM	I ² C	XTAL only	Blank	8	Si5351A/B/C-B
Si5351B-B-GM	I ² C	XTAL and/or Voltage	Blank	8	Si5351A/B/C-B
Si5351C-B-GM	I ² C	XTAL and/or CLKIN	Blank	8	Si5351A/B/C-B
Si5351A-Bxxxx-GT	I ² C	XTAL only	Factory Preprogrammed	3	Si5351A/B/C-B
Si5351A-Bxxxx-GM1	I ² C	XTAL only	Factory Preprogrammed	4	Si5351A/B/C-B
Si5351B-Bxxxx-GM1	I ² C	XTAL and/or Voltage	Factory Preprogrammed	4	Si5351A/B/C-B
Si5351C-Bxxxx-GM1	I ² C	XTAL and/or CLKIN	Factory Preprogrammed	4	Si5351A/B/C-B
Si5351A-Bxxxx-GM	I ² C	XTAL only	Factory Preprogrammed	8	Si5351A/B/C-B
Si5351B-Bxxxx-GM	I ² C	XTAL and/or Voltage	Factory Preprogrammed	8	Si5351A/B/C-B
Si5351C-Bxxxx-GM	I ² C	XTAL and/or CLKIN	Factory Preprogrammed	8	Si5351A/B/C-B
Si5350A-Bxxxx-GT	Pin	XTAL only	Factory Preprogrammed	3	Si5350A-B
Si5350A-Bxxxx-GM1	Pin	XTAL only	Factory Preprogrammed	4	Si5350A-B
Si5350A-Bxxxx-GM	Pin	XTAL only	Factory Preprogrammed	8	Si5350A-B
Si5350B-Bxxxx-GT	Pin	XTAL and/or Voltage	Factory Preprogrammed	3	Si5350B-B
Si5350B-Bxxxx-GM1	Pin	XTAL and/or Voltage	Factory Preprogrammed	4	Si5350B-B
Si5350B-Bxxxx-GM	Pin	XTAL and/or Voltage	Factory Preprogrammed	8	Si5350B-B
Si5350C-Bxxxx-GT	Pin	XTAL and/or CLKIN	Factory Preprogrammed	3	Si5350C-B
Si5350C-Bxxxx-GM1	Pin	XTAL and/or CLKIN	Factory Preprogrammed	4	Si5350C-B
Si5350C-Bxxxx-GM	Pin	XTAL and/or CLKIN	Factory Preprogrammed	8	Si5350C-B

2. Technical Support Resources

Table 2. Technical Support Resources

Resource	URL
Si5350/51 Frequently Asked Questions	https://www.skyworksinc.com/en/Products/Timing
ClockBuilder Pro (CBPro) Software	https://www.skyworksinc.com/en/Application-Pages/Clockbuilder-Pro-Software
Si535x Development Kits	https://www.skyworksinc.com/en/Products/Timing/Evaluation-Kits/si535x-b20qfn-evb-evaluation-kit

Si5350A-B

TABLE OF CONTENTS

Section	Page
1. Ordering Guide	2
2. Technical Support Resources	3
3. Electrical Specifications	5
4. Typical Application	11
4.1. Si5350A Replaces Multiple Clocks and XOs	11
4.2. Applying a Reference Clock at XTAL Input	11
4.3. HCSL Compatible Outputs	12
5. Functional Description	13
6. Configuring the Si5350A	14
6.1. Crystal Inputs (XA, XB)	14
6.2. Output Clocks (CLK0–CLK7)	14
6.3. Programmable Control Pins (P0–P4) Options	15
6.4. Design Considerations	18
7. Pin Descriptions	19
7.1. 20-Pin QFN	19
7.2. 16-Pin QFN	20
7.3. 10-Pin MSOP	21
8. Ordering Information	22
9. Packaging	23
9.1. 20-Pin QFN Package Outline	23
9.2. Land Pattern: 20-Pin QFN	25
9.3. 16-Pin QFN Package Outline	27
9.4. Land Pattern: 16-Pin QFN	29
9.5. 10-pin MSOP Package Outline	31
9.6. Land Pattern: 10-Pin MSOP	33
10. Top Marking	35
10.1. 20-Pin QFN Top Marking	35
10.2. Top Marking Explanation	35
10.3. 16-Pin QFN Top Marking	36
10.4. Top Marking Explanation	36
10.5. 10-Pin MSOP Top Marking	37
10.6. Top Marking Explanation	37
Revision History	38
Contact Information	39

3. Electrical Specifications

Table 3. Recommended Operating Conditions

Parameter	Symbol	Test Condition	Min	Typ	Max	Unit
Ambient Temperature	T_A		-40	25	85	°C
Core Supply Voltage	V_{DD}		1.71	1.8	1.89	V
			2.25	2.5	2.75	V
			3.0	3.3	3.60	V
Output Buffer Voltage	V_{DDOx}		1.71	1.8	1.89	V
			2.25	2.5	2.75	V
			3.0	3.3	3.60	V

Note: All minimum and maximum specifications are guaranteed and apply across the recommended operating conditions. Typical values apply at nominal supply voltages and an operating temperature of 25 °C unless otherwise noted. VDD and VDDOx can be operated at independent voltages. Power supply sequencing for VDD and VDDOx requires that all VDDOx be powered up either before or at the same time as VDD.

Table 4. DC Characteristics

($V_{DD} = 1.8\text{ V} \pm 5\%$, $2.5\text{ V} \pm 10\%$, or $3.3\text{ V} \pm 10\%$, $T_A = -40\text{ to }85\text{ °C}$)

Parameter	Symbol	Test Condition	Min	Typ	Max	Unit
Core Supply Current*	I_{DD}	Enabled 3 outputs	—	20	30	mA
		Enabled 4 outputs	—	21	32	mA
		Enabled 8 outputs	—	25	40	mA
		Power Down (PDN = VDD)	—	—	50	μA
Output Buffer Supply Current (Per Output)*	I_{DDOx}	$C_L = 5\text{ pF}$	—	2.2	5.6	mA
Input Current	I_{P1-P4}	Pins P1, P2, P3, P4 $V_{P1-P4} < 3.6\text{ V}$	—	—	10	μA
	I_{P0}	Pin P0	—	—	30	μA
Output Impedance	Z_{OI}	3.3 V VDDO, default high drive.	—	50	—	Ω

***Note:** Output clocks less than or equal to 100 MHz.

Si5350A-B

Table 5. AC Characteristics

($V_{DD} = 1.8\text{ V} \pm 5\%$, $2.5\text{ V} \pm 10\%$, or $3.3\text{ V} \pm 10\%$, $T_A = -40$ to $85\text{ }^\circ\text{C}$)

Parameter	Symbol	Test Condition	Min	Typ	Max	Unit
Powerup Time	T_{RDY}	From $V_{DD} = V_{DDmin}$ to valid output clock, $C_L = 5\text{ pF}$, $f_{CLKn} > 1\text{ MHz}$	—	2	10	ms
Powerup Time, PLL Bypass Mode	T_{BYP}	From $V_{DD} = V_{DDmin}$ to valid output clock, $C_L = 5\text{ pF}$, $f_{CLKn} > 1\text{ MHz}$	—	0.5	1	ms
Output Enable Time	T_{OE}	From OEB assertion to valid clock output, $C_L = 5\text{ pF}$, $f_{CLKn} > 1\text{ MHz}$	—	—	10	μs
Output Frequency Transition Time	T_{FREQ}	$f_{CLKn} > 1\text{ MHz}$	—	—	10	μs
Spread Spectrum Frequency Deviation	SS_{DEV}	Down spread. Selectable in 0.1% steps.	-0.1	—	-2.5	%
		Center spread. Selectable in 0.1% steps.	± 0.1	—	± 1.5	%
Spread Spectrum Modulation Rate	SS_{MOD}		30	31.5	33	kHz

Table 6. Input Characteristics

($V_{DD} = 1.8\text{ V} \pm 5\%$, $2.5\text{ V} \pm 10\%$, or $3.3\text{ V} \pm 10\%$, $T_A = -40$ to $85\text{ }^\circ\text{C}$)

Parameter	Symbol	Test Condition	Min	Typ	Max	Unit
Crystal Frequency	f_{XTAL}		25	—	27	MHz
P0-P4 Input Low Voltage	V_{IL_P0-4}		-0.1	—	$0.3 \times V_{DD}$	V
P0-P4 Input High Voltage	V_{IH_P0-4}	$V_{DD} = 2.5\text{ V}$ or 3.3 V	$0.7 \times V_{DD}$	—	3.60	V
		$V_{DD} = 1.8\text{ V}$	$0.8 \times V_{DD}$	—	3.60	V

Table 7. Output Characteristics

($V_{DD} = 1.8\text{ V} \pm 5\%$, $2.5\text{ V} \pm 10\%$, or $3.3\text{ V} \pm 10\%$, $T_A = -40$ to $85\text{ }^\circ\text{C}$)

Parameter	Symbol	Test Condition	Min	Typ	Max	Unit
Frequency Range ¹	F_{CLK}		0.0025	—	200	MHz
Load Capacitance	C_L	$F_{CLK} < 100\text{ MHz}$	—	—	15	pF
Duty Cycle	DC	$F_{CLK} \leq 160\text{ MHz}$, Measured at $V_{DD}/2$	45	50	55	%
		$F_{CLK} > 160\text{ MHz}$, Measured at $V_{DD}/2$	40	50	60	%

Notes:

1. Only two unique frequencies above 112.5 MHz can be simultaneously output.
2. Measured over 10k cycles. Jitter is only specified at the default high drive strength (50 Ω output impedance).
3. Jitter is highly dependent on device frequency configuration. Specifications represent a “worst case, real world” frequency plan; actual performance may be substantially better. Three-output 10MSOP package measured with clock outputs of 74.25, 24.576, and 48 MHz. Eight-output 20QFN package measured with clock outputs of 33.33, 74.25, 27, 24.576, 22.5792, 28.322, 125, and 48 MHz. Four-output, 16-QFN package measured with clock outputs of 33.333, 27, 28.322, and 48 MHz.

Table 7. Output Characteristics (Continued) $(V_{DD} = 1.8\text{ V} \pm 5\%, 2.5\text{ V} \pm 10\%, \text{ or } 3.3\text{ V} \pm 10\%, T_A = -40\text{ to } 85\text{ }^\circ\text{C})$

Parameter	Symbol	Test Condition	Min	Typ	Max	Unit
Rise/Fall Time	t_r/t_f	20%–80%, $C_L = 5\text{ pF}$	—	1	1.5	ns
Output High Voltage	V_{OH}		$V_{DD} - 0.6$	—	—	V
Output Low Voltage	V_{OL}		—	—	0.6	V
Period Jitter ^{2,3}	J_{PER}	16, 20-QFN, 4 outputs running, 1 per VDDO	—	40	95	ps pk-pk
		10-MSOP or 20-QFN, all outputs running	—	70	155	
Cycle-to-Cycle Jitter ^{2,3}	J_{CC}	16, 20-QFN, 4 outputs running, 1 per VDDO	—	50	90	ps pk
		10-MSOP or 20-QFN, all outputs running	—	70	150	

Notes:

1. Only two unique frequencies above 112.5 MHz can be simultaneously output.
2. Measured over 10k cycles. Jitter is only specified at the default high drive strength (50 Ω output impedance).
3. Jitter is highly dependent on device frequency configuration. Specifications represent a “worst case, real world” frequency plan; actual performance may be substantially better. Three-output 10MSOP package measured with clock outputs of 74.25, 24.576, and 48 MHz. Eight-output 20QFN package measured with clock outputs of 33.33, 74.25, 27, 24.576, 22.5792, 28.322, 125, and 48 MHz. Four-output, 16-QFN package measured with clock outputs of 33.333, 27, 28.322, and 48 MHz.

Table 8. 25 MHz Crystal Requirements^{1,2}

Parameter	Symbol	Min	Typ	Max	Unit
Crystal Frequency	f_{XTAL}	—	25	—	MHz
Load Capacitance	C_L	6	—	12	pF
Equivalent Series Resistance	r_{ESR}	—	—	150	Ω
Crystal Max Drive Level	d_L	100	—	—	μW

Notes:

1. Crystals which require load capacitances of 6, 8, or 10 pF should use the device's internal load capacitance for optimum performance. A crystal with a 12 pF load capacitance requirement should use a combination of the internal 10 pF load capacitance in addition to external 2 pF load capacitance (e.g., by using 4pF capacitors on XA and XB). ClockBuilder Pro can be used to configure the internal load capacitors.
2. Refer to “AN551: Crystal Selection Guide” for more details.

Si5350A-B

Table 9. 27 MHz Crystal Requirements^{1,2}

Parameter	Symbol	Min	Typ	Max	Unit
Crystal Frequency	f_{XTAL}	—	27	—	MHz
Load Capacitance	C_L	6	—	12	pF
Equivalent Series Resistance	r_{ESR}	—	—	150	Ω
Crystal Max Drive Level Spec	d_L	100	—	—	μW

Notes:

- Crystals which require load capacitances of 6, 8, or 10 pF should use the device's internal load capacitance for optimum performance. A crystal with a 12 pF load capacitance requirement should use a combination of the internal 10 pF load capacitance in addition to external 2 pF load capacitance (e.g., by using 4pF capacitors on XA and XB). ClockBuilder Pro can be used to configure the internal load capacitors.
- Refer to "AN551: Crystal Selection Guide" for more details.

Table 10. Thermal Characteristics (2-Layer Board)

Parameter	Symbol	Test Condition	Package	Value	Unit
Thermal Resistance Junction to Ambient	θ_{JA}	Still Air ¹	10-MSOP	150	$^{\circ}C/W$
			16-QFN	103	$^{\circ}C/W$
			20-QFN	74.9	$^{\circ}C/W$
Thermal Resistance Junction to Board	Ψ_{JB}	Still Air ¹	10-MSOP	82	$^{\circ}C/W$
			16-QFN	37	$^{\circ}C/W$
			20-QFN	9.94	$^{\circ}C/W$
Thermal Resistance Junction to Top Center	Ψ_{JT}	Still Air ¹	10-MSOP	0.84	$^{\circ}C/W$
			16-QFN	4.26	$^{\circ}C/W$
			20-QFN	1.3	$^{\circ}C/W$

Notes:

- Based on environment and board designed per JESD51-2A and JESD51-3.

Table 11. Thermal Characteristics (4-Layer Board)

Parameter	Symbol	Test Condition	Package	Value	Unit
Thermal Resistance Junction to Ambient	θ_{JA}	Still Air ¹	10-MSOP	126	°C/W
			16-QFN	65	°C/W
			20-QFN	41	°C/W
Thermal Resistance Junction to Board	θ_{JB}	Junction to Board ²	10-MSOP	84	°C/W
			16-QFN	48	°C/W
			20-QFN	16	°C/W
	Ψ_{JB}	Still Air ¹	10-MSOP	83	°C/W
			16-QFN	31	°C/W
			20-QFN	8.1	°C/W
Thermal Resistance Junction to Top Center	Ψ_{JT}	Still Air ¹	10-MSOP	0.74	°C/W
			16-QFN	3.8	°C/W
			20-QFN	0.98	°C/W

Notes:

1. Based on environment and board designed per JESD51-2A, JESD51-5, and JESD51-7.
2. Based on conditions set in JESD51-8.

Table 12. Thermal Characteristics (Junction-to-Case)

Parameter	Symbol	Test Condition	Package	Value	Unit
Thermal Resistance Junction to Case ¹	θ_{JC}	Still Air	10-MSOP	36	°C/W
			16-QFN	82	°C/W
			20-QFN	51	°C/W

Notes:

1. Based on board designed per JESD51-1 (Top center of packages used).

Si5350A-B

Table 13. Absolute Maximum Ratings¹

Parameter	Symbol	Test Condition	Value	Unit
DC Supply Voltage	V_{DD_max}		-0.5 to 3.8	V
Input Voltage	V_{IN_P1-4}	Pins P1, P2, P3, P4	-0.5 to 3.8	V
	V_{IN_P0}	P0	-0.5 to ($V_{DD}+0.3$)	V
	$V_{IN_XA/B}$	Pins XA, XB	-0.5 to 1.3 V	V
Junction Temperature	T_J		-55 to 150	°C
Soldering Temperature (Pb-free profile) ²	T_{PEAK}		260	°C
Soldering Temperature Time at T_{PEAK} (Pb-free profile) ²	T_P		20–40	Sec
Notes: <ol style="list-style-type: none">1. Permanent device damage may occur if the absolute maximum ratings are exceeded. Functional operation should be restricted to the conditions as specified in the operational sections of this data sheet. Exposure to absolute maximum rating conditions for extended periods may affect device reliability.2. The device is compliant with JEDEC J-STD-020.				

4. Typical Application

4.1. Si5350A Replaces Multiple Clocks and XOs

The Si5350A is a user-definable custom clock generator that is ideally suited for replacing crystals and crystal oscillators in cost-sensitive applications. An example application is shown in Figure 1.



Figure 1. Example of an Si5350A in an Audio/Video Application

4.2. Applying a Reference Clock at XTAL Input

The Si5350A can be driven with a clock signal through the XA input pin.



Figure 2. Si5350A Driven by a Clock Signal

Si5350A-B

4.3. HCSL Compatible Outputs

The Si5350A can be configured to support HCSL compatible swing when the VDDO of the output pair of interest is set to 2.5 V (i.e., VDDOA must be 2.5 V when using CLK0/1; VDDOB must be 2.5 V for CLK2/3 and so on).

The circuit in Figure 3 must be applied to each of the two clocks used, and one of the clocks in the pair must also be inverted to generate a differential pair. This functionality is only supported for the Si5350A in 10-MSOP or 20-QFN packages.



Figure 3. Si5350A Output is HCSL Compatible

5. Functional Description

The Si5350A's synthesis architecture consists of two high-frequency PLLs in addition to one high-resolution fractional MultiSynth™ divider per output. Block diagrams of the 3-, 4-, and 8-output versions are shown in Figure 4. This unique architecture allows the Si5350A to simultaneously generate up to eight independent, non-integer-related frequencies. In addition, some MultiSynth™ dividers are configurable with two different frequencies (F1_x, F2_x). This allows a pin-controlled, glitchless frequency change at the corresponding output (CLK0 to CLK2).



Figure 4. Block Diagrams of 3-Output, 4-Output, and 8-Output Si5350A Devices

6. Configuring the Si5350A

The Si5350A is a factory-programmed custom clock generator that is user-definable with [ClockBuilder Pro](#). The ClockBuilder Pro utility provides a simple graphical interface that allows the user to enter input and output frequencies along with other custom features as described in the following sections. All synthesis calculations are automatically performed by ClockBuilder Pro to ensure an optimum configuration. A unique part number is assigned to each custom configuration.

6.1. Crystal Inputs (XA, XB)

The Si5350A uses a fixed-frequency standard AT-cut crystal as a reference to synthesize its output clocks.

6.1.1. Crystal Frequency

The Si5350A can operate using either a 27 MHz or a 25 MHz crystal.

6.1.2. Internal XTAL Load Capacitors

Internal load capacitors are provided to eliminate the need for external components when connecting a XTAL to the Si5350A. The total internal XTAL load capacitance (C_L) can be selected to be 0, 6, 8, or 10 pF. XTALs with alternate load capacitance requirements are supported by ClockBuilder Pro using additional external load capacitance ≤ 2 pF (e.g., by using ≤ 4 pF capacitors on XA and XB) as shown in Figure 5.



Figure 5. External XTAL with Optional Load Capacitors

6.2. Output Clocks (CLK0–CLK7)

The Si5350A is orderable as a 3-output (10-MSOP), 4-output (16-QFN), or 8-output (20-QFN) clock generator. Output clocks CLK0-2 for 20-QFN and 10-MSOP devices and CLK0-1 for 16-QFN devices can be ordered with two clock frequencies ($F1_x$, $F2_x$), which are selectable with the optional frequency select pins ($FS0/1$). See “6.3.3. Frequency Select (FS_0 , FS_1)” for more details on the operation of the frequency select pins.

6.2.1. Output Clock Frequency

Outputs can be configured at any frequency from 2.5 kHz up to 200 MHz. However, only two unique frequencies above 112.5 MHz can be simultaneously output. For example, 125 MHz (CLK0), 130 MHz (CLK1), and 150 MHz (CLKx) is not allowed. Note that multiple copies of frequencies above 112.5 MHz can be provided, for example, 125 MHz could be provided on four outputs (CLKS0-3) simultaneously with 130 MHz on four different outputs (CLKS4-7).

6.2.2. Spread Spectrum

Spread spectrum can be enabled on any of the clock outputs that use PLLA as its reference. Spread spectrum is useful for reducing electromagnetic interference (EMI). Enabling spread spectrum on an output clock modulates its frequency, which effectively reduces the overall amplitude of its radiated energy. Note that spread spectrum is not available on clocks synchronized to PLLB.

The Si5350A supports several levels of spread spectrum allowing the designer to choose an ideal compromise between system performance and EMI compliance. An optional spread-spectrum enable pin (SSEN) is configurable to enable or disable the spread spectrum feature. See “6.3.1. Spread Spectrum Enable (SSEN)” for details.



Figure 6. Available Spread Spectrum Profiles

6.2.3. Invert/Non-Invert

By default, each of the output clocks are generated in phase (non-inverted) with respect to each other. An option to invert any of the clock outputs is also available.

6.2.4. Output State When Disabled

There are up to three output enable pins configurable on the Si5350A as described in “6.3.4. Output Enable (OEB_0, OEB_1, OEB_2)”. The output state when disabled for each of the outputs is configurable as output high, output low, or high-impedance.

6.2.5. Powering Down Unused Outputs

Unused clock outputs can be completely powered down to conserve power.

6.3. Programmable Control Pins (P0–P4) Options

Up to five programmable control pins (P0-P4) are configurable allowing direct pin control of the following features:

6.3.1. Spread Spectrum Enable (SSEN)

An optional control pin allows disabling the spread spectrum feature for all outputs that were configured with spread spectrum enabled. Hold SSEN low to disable spread spectrum. The SSEN pin provides a convenient method of evaluating the effect of using spread spectrum clocks during EMI compliance testing.

6.3.2. Power Down (PDN)

An optional power down control pin allows a full shutdown of the Si5350A to minimize power consumption when its output clocks are not being used. The Si5350A is in normal operation when the PDN pin is held low and is in power down mode when held high. Power consumption when the device is in power down mode is indicated in Table 4 on page 5.

6.3.3. Frequency Select (FS_0, FS_1)

The Si5350A offers the option of configuring up to two frequencies per clock output on CLK0-2 for 20-QFN and 10-MSOP devices and CLK0-1 for 16-QFN devices. This is a useful feature for applications that need to support more than one clock rate on the same output. An example of this is shown in Figure 7 where the FS pins selects which frequency is generated from the clock output: F1_0 is generated when FS is set low, and F2_0 is generated when FS is set high.



Figure 7. Example of Generating Two Clock Frequencies from the Same Clock Output

Si5350A-B

Up to two frequency select pins are available on the Si5350A. Each of the frequency select pins can be linked to CLK0, 1, and 2 for 20-QFN and 10-MSOP devices. 16-QFN devices allow frequency select on CLK0 and CLK1. See Figure 8 for an example of a potential 20-QFN frequency select configuration. In this example, FS_0 is linked to control clock frequency selection on CLK0; FS_1 can be used to control clock frequency selection on CLK1 and CLK2. Any other combination is also possible. The frequency select feature is not available for CLK3/4/5/6/7 in 20-QFN devices or for CLK2/3 in 16-QFN devices.

The Si5350A uses control circuitry to ensure that frequency changes are glitchless. This ensures that the clock always completes its last cycle before starting a new clock cycle of a different frequency.



Figure 8. Example Configuration of a Pin-Controlled Frequency Select (FS)

6.3.4. Output Enable (OEB_0, OEB_1, OEB_2)

Up to three output enable pins (OEB_0/1/2) are available on the Si5350A. Each OEB pin can be linked to any of the output clocks. In the example shown in Figure 9, OEB_0 is linked to control CLK0, CLK3, and CLK5; OEB_1 is linked to control CLK6 and CLK7, and OEB_2 is linked to control CLK1, CLK2, CLK4, and CLK5. Any other combination is also possible. If more than one OEB pin is linked to the same CLK output, the pin forcing a disable state will be dominant. Clock outputs are enabled when the OEB pin is held low.

The output enable control circuitry ensures glitchless operation by starting the output clock cycle on the first leading edge after OEB is asserted (OEB = low). When OEB is released (OEB = high), the clock is allowed to complete its full clock cycle before going into a disabled state. This is shown in Figure 9. When disabled, the output state is configurable as disabled high, disabled low, or disabled in high-impedance.



Figure 9. Example Configuration of a Pin-Controlled Output Enable

Si5350A-B

6.4. Design Considerations

The Si5350A is a self-contained clock generator that requires very few external components. The following general guidelines are recommended to ensure optimum performance.

6.4.1. Power Supply Decoupling/Filtering

The Si5350A has built-in power supply filtering circuitry to help keep the number of external components to a minimum. All that is recommended is one 0.1 to 1.0 μF decoupling capacitor per power supply pin. This capacitor should be mounted as close to the VDD and VDDO pins as possible without using vias.

6.4.2. Power Supply Sequencing

The VDD and VDDOx (i.e., VDDO0, VDDO1, VDDO2, VDDO3) power supply pins have been separated to allow flexibility in output signal levels. Power supply sequencing for VDD and VDDOx requires that all VDDOx be powered up either before or at the same time as VDD. Unused VDDOx pins should be tied to VDD.

6.4.3. External Crystal

The external crystal should be mounted as close to the pins as possible using short PCB traces. The XA and XB traces should be kept away from other high-speed signal traces. See “AN551: Crystal Selection Guide” for more details.

6.4.4. External Crystal Load Capacitors

The Si5350A provides the option of using internal and external crystal load capacitors. If external load capacitors are used, they should be placed as close to the XA/XB pads as possible. See “AN551: Crystal Selection Guide” for more details.

6.4.5. Unused Pins

- Unused control pins (P0–P4) should be tied to GND.
- Unused XA/XB pins should be left floating. Refer to “4.2. Applying a Reference Clock at XTAL Input” on page 9 when using XA as a clock input pin.
- Unused output pins (CLK0, CLK7) should be left floating.
- Unused VDDOx pins should be tied to VDD.

6.4.6. Trace Characteristics

The Si5350A features various output drive strength settings. It is recommended to configure the trace characteristics as shown in Figure 10 when the default high output drive setting is used.



Figure 10. Recommended Trace Characteristics with Default Drive Strength Setting

7. Pin Descriptions

7.1. 20-Pin QFN



Figure 11. Si5350A 20-Pin QFN Top View

Pin Name	Pin Number	Pin Type*	Function
XA	1	I	Input pin for external XTAL.
XB	2	I	Input pin for external XTAL.
CLK0	13	O	Output Clock 0.
CLK1	12	O	Output Clock 1.
CLK2	9	O	Output Clock 2.
CLK3	8	O	Output Clock 3.
CLK4	19	O	Output Clock 4.
CLK5	17	O	Output Clock 5.
CLK6	16	O	Output Clock 6.
CLK7	15	O	Output Clock 7.
P0	3	I	User configurable input pin 0. See Section 6.3.
P1	4	I	User configurable input pin 1. See Section 6.3.
P2	5	I	User configurable input pin 2. See Section 6.3.
P3	6	I	User configurable input pin 3. See Section 6.3.
P4	7	I	User configurable input pin 4. See Section 6.3.
VDD	20	P	Core voltage supply pin. See Section 6.4.2.
VDDOA	11	P	Output voltage supply pin for CLK0 and CLK1. See Section 6.4.2.
VDDOB	10	P	Output voltage supply pin for CLK2 and CLK3. See Section 6.4.2.
VDDOC	18	P	Output voltage supply pin for CLK4 and CLK5. See Section 6.4.2.
VDDOD	14	P	Output voltage supply pin for CLK6 and CLK7. See Section 6.4.2.
GND	Center Pad	P	Ground.

***Note:** I = Input, O = Output, P = Power

Si5350A-B

7.2. 16-Pin QFN



Figure 12. Si5350A 16-Pin QFN Top View

Pin Name	Pin Number	Pin Type*	Function
XA	1	I	Input pin for external crystal.
XB	2	I	Input pin for external crystal.
P0	3	I	User configurable input P0. See Section 6.3.
P1	4	I	User configurable input P1. See Section 6.3.
P2	5	I	User configurable input P2. See Section 6.3.
P3	6	I	User configurable input P3. See Section 6.3.
CLK1	7	O	Output Clock 1.
VDDOB	8	P	Output voltage supply pin for CLK1. See Section 6.4.2.
VDDOA	9	P	Output voltage supply pin for CLK0. See Section 6.4.2.
CLK0	10	O	Output Clock 0.
VDDOD	11	P	Output voltage supply pin for CLK3. See Section 6.4.2.
CLK3	12	O	Output Clock 3.
CLK2	13	O	Output Clock 2.
VDDOC	14	P	Output voltage supply pin for CLK2. See Section 6.4.2.
GND	15	GND	Ground.
VDD	16	P	Core voltage supply pin. See Section 6.4.2.
GND PAD	Center Pad	GND	Ground pad. Use multiple vias to ensure a solid path to Ground.

***Note:** I = Input, O = Output, P = Power; Input pins are not internally pulled up.

7.3. 10-Pin MSOP



Figure 13. Si5350A 10-Pin MSOP Top View

Pin Name	Pin Number	Pin Type*	Function
XA	2	I	Input pin for external XTAL.
XB	3	I	Input pin for external XTAL.
CLK0	10	O	Output clock 0.
CLK1	9	O	Output clock 1.
CLK2	6	O	Output clock 2.
P0	4	I	User configurable input pin 0. See Section 6.3.
P1	5	I	User configurable input pin 1. See Section 6.3.
VDD	1	P	Core voltage supply pin. See Section 6.4.2.
VDDO	7	P	Output clock voltage supply pin for CLK0, CLK1, and CLK2. See Section 6.4.2.
GND	8	P	Ground.

***Note:** I = Input, O = Output, P = Power

Si5350A-B

8. Ordering Information

Factory programmed Si5350A devices can be requested through [ClockBuilder Pro](#). A unique part number is assigned to each custom configuration as indicated in Figure 14. Use ClockBuilder Pro to create custom part numbers or consult a Skyworks Solutions sales representative for other custom NVM configurations.

The [Si5351x-B20QFN-EVB](#) evaluation kit, along with ClockBuilder Pro, enables easy testing of any Si5350A frequency plan. ClockBuilder Pro makes it simple to emulate all three Si5351 packages, including the 10-MSOP, 20-QFN, and 16-QFN, on the same evaluation board.



Evaluation Boards

Si535x-B20QFN-EVB

— For evaluation of:

Si5350A-Bxxxxx-GM (20-QFN)

Si5350A-Bxxxxx-GM1 (16-QFN)

Si5350A-Bxxxxx-GT (10-MSOP)

Figure 14. Custom Clock Part Numbers

9. Packaging

9.1. 20-Pin QFN Package Outline

Figure 15 illustrates the package details for the Si5350A-B in a 20-pin QFN package. Table 14 lists the values for the dimensions shown in the illustration.



Figure 15. 20-pin QFN Package Drawing

Table 14. Package Dimensions

Dimension	Min	Nom	Max
A	0.80	0.85	0.90
A1	0.00	—	0.05
b	0.20	0.25	0.30
D	4.00 BSC		
D2	2.65	2.70	2.75
e	0.50 BSC		
E	4.00 BSC		
E2	2.65	2.70	2.75
L	0.35	0.40	0.45
aaa	—	—	0.10
bbb	—	—	0.10
ccc	—	—	0.08
ddd	—	—	0.10
Notes: <ol style="list-style-type: none">1. All dimensions shown are in millimeters (mm) unless otherwise noted.2. Dimensioning and Tolerancing per ANSI Y14.5M-1994.3. This drawing conforms to JEDEC Outline MO-220, variation VGGD-5.4. Recommended card reflow profile is per the JEDEC/IPC J-STD-020 specification for Small Body Components.			

9.2. Land Pattern: 20-Pin QFN

Figure 16 shows the recommended land pattern details for the Si5350 in a 20-Pin QFN package. Table 15 lists the values for the dimensions shown in the illustration.



Figure 16. 20-Pin QFN Land Pattern

Table 15. PCB Land Pattern Dimensions

Symbol	Millimeters
C1	4.0
C2	4.0
E	0.50 BSC
X1	0.30
X2	2.70
Y1	0.80
Y2	2.70

Notes:

General

1. All dimensions shown are in millimeters (mm) unless otherwise noted.
2. This land pattern design is based on IPC-7351 guidelines.

Solder Mask Design

3. All metal pads are to be non-solder mask defined (NSMD). Clearance between the solder mask and the metal pad is to be 60 µm minimum, all the way around the pad.

Stencil Design

4. A stainless steel, laser-cut and electro-polished stencil with trapezoidal walls should be used to assure good solder paste release.
5. The stencil thickness should be 0.125 mm (5 mils).
6. The ratio of stencil aperture to land pad size should be 1:1 for all perimeter pads.
7. A 2x2 array of 1.10 x 1.10 mm openings on 1.30 mm pitch should be used for the center ground pad.

Card Assembly

8. A No-Clean, Type-3 solder paste is recommended.
9. The recommended card reflow profile is per the JEDEC/IPC J-STD-020 specification for Small Body components.

9.3. 16-Pin QFN Package Outline

Figure 17 illustrates the package details for the Si5350A-B in a 16-QFN package. Table 16 lists the values for the dimensions shown in the illustration.



Figure 17. 16-Pin QFN Package Drawing

Table 16. Package Dimensions

Dimension	Min	Nom	Max
A	0.80	0.85	0.90
A1	0.00	0.02	0.05
A3	0.20 REF.		
b	0.18	0.25	0.30
D	3.0 BSC		
D2	1.70	1.80	1.90
e	0.50 BSC		
E	3.0 BSC		
E2	1.70	1.80	1.90
L	0.25	0.35	0.45
K	0.20	—	—
R	0.09	—	0.14
aaa	0.15		
bbb	0.10		
ccc	0.10		
ddd	0.05		
eee	0.08		
fff	0.10		
Notes: <ol style="list-style-type: none">1. All dimensions shown are in millimeters (mm) unless otherwise noted.2. Dimensioning and Tolerancing per ANSI Y14.5M-1994.3. Recommended card reflow profile is per the JEDEC/IPC J-STD-020 specification for Small Body Components.			

9.4. Land Pattern: 16-Pin QFN

Figure 18 shows the recommended land pattern details for the Si5350 in a 16-QFN package. Table 17 lists the values for the dimensions shown in the illustration.



Figure 18. 16-Pin QFN Land Pattern

Table 17. PCB Land Pattern Dimensions

Symbol	Millimeters
C1	3.00
C2	3.00
E	0.50
X1	0.30
Y1	0.75
X2	1.80
Y2	1.80

Notes:

General

1. All dimensions shown are in millimeters (mm).
2. This land pattern design is based on IPC-7351 guidelines.
3. All dimensions shown are at Maximum Material Condition (MMC). Least Material Condition (LMC) is calculated based on a Fabrication Allowance of 0.05 mm.

Solder Mask Design

4. All metal pads are to be non-solder mask defined (NSMD). Clearance between the solder mask and the metal pad is to be 60 μm minimum, all the way around the pad.

Stencil Design

5. A stainless steel, laser-cut and electro-polished stencil with trapezoidal walls should be used to assure good solder paste release.
6. The stencil thickness should be 0.125 mm (5 mils).
7. The ratio of stencil aperture to land pad size should be 1:1 for all perimeter pads.
8. A 2x2 array of 0.65 mm square openings on a 0.90 mm pitch should be used for the center ground pad.

Card Assembly

9. A No-Clean, Type-3 solder paste is recommended.
10. The recommended card reflow profile is per the JEDEC/IPC J-STD-020 specification for Small Body components.
11. The above notes and stencil design are shared as recommendations only. A customer or user may find it necessary to use different parameters and fine-tune their SMT process as required for their application and tooling.

9.5. 10-pin MSOP Package Outline

Figure 19 illustrates the package details for the Si5350A-B in a 10-pin MSOP package. Table 18 lists the values for the dimensions shown in the illustration.



Figure 19. 10-pin MSOP Package Drawing

Table 18. 10-MSOP Package Dimensions

Dimension	Min	Nom	Max
A	—	—	1.10
A1	0.00	—	0.15
A2	0.75	0.85	0.95
b	0.17	—	0.33
c	0.08	—	0.23
D	3.00 BSC		
E	4.90 BSC		
E1	3.00 BSC		
e	0.50 BSC		
L	0.40	0.60	0.80
L2	0.25 BSC		
q	0	—	8
aaa	—	—	0.20
bbb	—	—	0.25
ccc	—	—	0.10
ddd	—	—	0.08

Notes:

1. All dimensions shown are in millimeters (mm) unless otherwise noted.
2. Dimensioning and Tolerancing per ANSI Y14.5M-1994.
3. This drawing conforms to the JEDEC Solid State Outline MO-137, Variation C
4. Recommended card reflow profile is per the JEDEC/IPC J-STD-020 specification for Small Body Components.

9.6. Land Pattern: 10-Pin MSOP

Figure 20 shows the recommended land pattern details for the Si5350A-B in a 10-Pin MSOP package. Table 19 lists the values for the dimensions shown in the illustration.



Figure 20. 10-Pin MSOP Land Pattern

Table 19. PCB Land Pattern Dimensions

Symbol	Millimeters	
	Min	Max
C1	4.40 REF	
E	0.50 BSC	
G1	3.00	—
X1	—	0.30
Y1	1.40 REF	
Z1	—	5.80

Notes:

General

1. All dimensions shown are in millimeters (mm) unless otherwise noted.
2. Dimensioning and Tolerancing per ASME Y14.5M-1994.
3. This Land Pattern Design is based on the IPC-7351 guidelines.
4. All dimensions shown are at Maximum Material Condition (MMC). Least Material Condition (LMC) is calculated based on a Fabrication Allowance of 0.05mm.

Solder Mask Design

5. All metal pads are to be non-solder mask defined (NSMD). Clearance between the solder mask and the metal pad is to be 60 µm minimum, all the way around the pad.

Stencil Design

6. A stainless steel, laser-cut and electro-polished stencil with trapezoidal walls should be used to assure good solder paste release.
7. The stencil thickness should be 0.125 mm (5 mils).
8. The ratio of stencil aperture to land pad size should be 1:1.

Card Assembly

9. A No-Clean, Type-3 solder paste is recommended.
10. The recommended card reflow profile is per the JEDEC/IPC J-STD-020C specification for Small Body components.

10. Top Marking

10.1. 20-Pin QFN Top Marking



Figure 21. 20-Pin QFN Top Marking

10.2. Top Marking Explanation

Mark Method:	Laser	
Pin 1 Mark:	Filled Circle = 0.50 mm Diameter (Bottom-Left Corner)	
Font Size:	0.60 mm (24 mils)	
Line 1 Mark Format	Device Part Number	Si5350
Line 2 Mark Format:	TTTTTT = Mfg Code*	Manufacturing Code from the Assembly Purchase Order Form.
Line 3 Mark Format:	YY = Year WW = Work Week	Assigned by the Assembly House. Corresponds to the year and work week of the assembly date.
*Note: The code shown in the “TTTTTT” line does not correspond to the orderable part number or frequency plan. It is used for package assembly quality tracking purposes only.		

Si5350A-B

10.3. 16-Pin QFN Top Marking



Figure 22. 16-Pin QFN Top Marking

10.4. Top Marking Explanation

Mark Method:	Laser	
Pin 1 Mark:	Circle (Bottom-Left Corner)	
Font Size:	0.60 mm (24 mils)	
Line 1 Mark Format	Device Part Number	5350
Line 2 Mark Format:	TTTT = Mfg Code*	Manufacturing Code from the Assembly Purchase Order Form.
Line 3 Mark Format:	YWW = Date Code	Assigned by the Assembly House. Y = Last digit of the current year. WW = Work week of the assembly date.
*Note: The code shown in the "TTTT" line does not correspond to the orderable part number or frequency plan. It is used for package assembly quality tracking purposes only.		

10.5. 10-Pin MSOP Top Marking



Figure 23. 10-Pin MSOP Top Marking

10.6. Top Marking Explanation

Mark Method:	Laser	
Pin 1 Mark:	Mold Dimple (Bottom-Left Corner)	
Font Size:	0.60 mm (24 mils)	
Line 1 Mark Format	Device Part Number	Si5350
Line 2 Mark Format:	TTTT = Mfg Code*	Line 2 from the “Markings” section of the Assembly Purchase Order form.
Line 3 Mark Format:	YWW = Date Code	Assigned by the Assembly House. Y = Last Digit of Current Year (Ex: 2013 = 3) WW = Work Week of Assembly Date.
<p>*Note: The code shown in the “TTTT” line does not correspond to the orderable part number or frequency plan. It is used for package assembly quality tracking purposes only.</p>		

REVISION HISTORY

Revision 1.2

March, 2020

- Added "1. Ordering Guide" on page 2.
- Updated "3. Electrical Specifications" on page 5.
 - Updated Tables 5, 7, 12, and 13 to include 16-QFN parameters.
 - Updated thermal characteristics tables to include Table 10 (2-Layer Board), Table 11 (4-Layer Board), and Table 12 (Junction-to-Case).
- Updated "4. Typical Application" on page 11.
 - Updated "4.3. HCSL Compatible Outputs" on page 12.
- Updated "5. Functional Description" on page 13.
- Updated "6. Configuring the Si5350A" on page 14.
 - Updated "6.2. Output Clocks (CLK0–CLK7)" on page 14.
 - Updated "6.3.3. Frequency Select (FS_0, FS_1)" on page 15.
 - Updated "6.4.5. Unused Pins" on page 18.
- Updated "7. Pin Descriptions" on page 19.
 - Added 16-QFN information.
- Updated "8. Ordering Information" on page 22.
 - Updated EVB and 16-QFN information.
- Updated "9. Packaging" on page 23.
 - Added 16-QFN information.

Revision 1.1

August, 2018

- Updated "8. Ordering Information" on page 22.
 - Changed "Blank = Bulk" to "Blank = Coil Tape" in Figure 14.

Revision 1.0

April, 2015

- Extended frequency range from 8 MHz-160 MHz to 2.5 kHz-200 MHz.
- Added 1.8 V VDD support.
- Updated block diagrams for clarity.
- Added complete Si5350/1 family table, Table 1.
- Added top mark information.
- Added land pattern drawings.
- Added PowerUp Time, PLL Bypass mode, Table 5.
- Clarified Down Spread step sizes in Table 5.
- Updated max jitter specs (typ unchanged) in Table 7.
- Clarified power supply sequencing requirement, Section 4.4.2.

Revision 0.75

October, 2012

- Initial release.



SKYWORKS®

ClockBuilder Pro

Customize Skyworks clock generators, jitter attenuators and network synchronizers with a single tool. With CBPro you can control evaluation boards, access documentation, request a custom part number, export for in-system programming and more!

www.skyworksinc.com/CBPro



Portfolio

www.skyworksinc.com/ia/timing



SW/HW

www.skyworksinc.com/CBPro



Quality

www.skyworksinc.com/quality



Support & Resources

www.skyworksinc.com/support

Copyright © 2021 Skyworks Solutions, Inc. All Rights Reserved.

Information in this document is provided in connection with Skyworks Solutions, Inc. ("Skyworks") products or services. These materials, including the information contained herein, are provided by Skyworks as a service to its customers and may be used for informational purposes only by the customer. Skyworks assumes no responsibility for errors or omissions in these materials or the information contained herein. Skyworks may change its documentation, products, services, specifications or product descriptions at any time, without notice. Skyworks makes no commitment to update the materials or information and shall have no responsibility whatsoever for conflicts, incompatibilities, or other difficulties arising from any future changes.

No license, whether express, implied, by estoppel or otherwise, is granted to any intellectual property rights by this document. Skyworks assumes no liability for any materials, products or information provided hereunder, including the sale, distribution, reproduction or use of Skyworks products, information or materials, except as may be provided in Skyworks' Terms and Conditions of Sale.

THE MATERIALS, PRODUCTS AND INFORMATION ARE PROVIDED "AS IS" WITHOUT WARRANTY OF ANY KIND, WHETHER EXPRESS, IMPLIED, STATUTORY, OR OTHERWISE, INCLUDING FITNESS FOR A PARTICULAR PURPOSE OR USE, MERCHANTABILITY, PERFORMANCE, QUALITY OR NON-INFRINGEMENT OF ANY INTELLECTUAL PROPERTY RIGHT; ALL SUCH WARRANTIES ARE HEREBY EXPRESSLY DISCLAIMED. SKYWORKS DOES NOT WARRANT THE ACCURACY OR COMPLETENESS OF THE INFORMATION, TEXT, GRAPHICS OR OTHER ITEMS CONTAINED WITHIN THESE MATERIALS. SKYWORKS SHALL NOT BE LIABLE FOR ANY DAMAGES, INCLUDING BUT NOT LIMITED TO ANY SPECIAL, INDIRECT, INCIDENTAL, STATUTORY, OR CONSEQUENTIAL DAMAGES, INCLUDING WITHOUT LIMITATION, LOST REVENUES OR LOST PROFITS THAT MAY RESULT FROM THE USE OF THE MATERIALS OR INFORMATION, WHETHER OR NOT THE RECIPIENT OF MATERIALS HAS BEEN ADVISED OF THE POSSIBILITY OF SUCH DAMAGE.

Skyworks products are not intended for use in medical, lifesaving or life-sustaining applications, or other equipment in which the failure of the Skyworks products could lead to personal injury, death, physical or environmental damage. Skyworks customers using or selling Skyworks products for use in such applications do so at their own risk and agree to fully indemnify Skyworks for any damages resulting from such improper use or sale.

Customers are responsible for their products and applications using Skyworks products, which may deviate from published specifications as a result of design defects, errors, or operation of products outside of published parameters or design specifications. Customers should include design and operating safeguards to minimize these and other risks. Skyworks assumes no liability for applications assistance, customer product design, or damage to any equipment resulting from the use of Skyworks products outside of Skyworks' published specifications or parameters.



Skyworks, the Skyworks symbol, Sky5®, SkyOne®, SkyBlue™, Skyworks Green™, Clockbuilder®, DSPLL®, ISOModem®, ProSLIC®, and SiPHY® are trademarks or registered trademarks of Skyworks Solutions, Inc. or its subsidiaries in the United States and other countries. Third-party brands and names are for identification purposes only and are the property of their respective owners. Additional information, including relevant terms and conditions, posted at www.skyworksinc.com, are incorporated by reference.

Skyworks Solutions, Inc. | Nasdaq: SWKS | sales@skyworksinc.com | www.skyworksinc.com





USA: 781-376-3000 | Asia: 886-2-2735 0399 | Europe: 33 (0)1 43548540 |    

Looking for pricing, stock, or lifecycle information?

Click below to explore more details on WIN SOURCE:

-  [View SI5350A-B04499-GTR on WIN SOURCE](#)
-  [Skyworks Solutions Inc. Information](#)

Optimize Your Supply Chain with WIN SOURCE Solutions

-  Global Sourcing Solution
-  Obsolete Management
-  Cost Control Management
-  Shortage Management
-  Alternative Solution
-  Excess Inventory Management