



**THE DATASHEET OF
SI5332D-D-AM1**



Si5332-AM Automotive Grade Clock Generator with SmartClock™ Technology

AEC-Q100 Qualified, Any-Frequency Clock Generator

Based on Skyworks' proprietary MultiSynth™ flexible frequency synthesis technology, the automotive grade Si5332-AM generates any combination of output frequencies with excellent jitter performance (190 fs rms). The device's highly flexible architecture enables a single device to generate a wide range of integer and non-integer related frequencies on up to 12 differential clock outputs with 0 ppm frequency synthesis error. The device offers multiple banks of outputs that can each be tied to independent voltages, enabling usage in mixed-supply applications. Further, the signal format of each clock output is user-configurable. Given its frequency, format, and supply voltage flexibility, the Si5332-AM is ideally suited to replace multiple clock ICs and oscillators with a single device.

The Si5332-AM comes equipped with SmartClock™ technology, providing the capability of monitoring the health of reference inputs, detecting faults, communicating faults to a system safety manager, and, with external control, switching over to a redundant backup source in the event of a fault. In the event of primary and redundant input reference failure, AlwaysOn mode allows the output clocks to continue operating within +/-5% of the desired output frequency.

The Si5332-AM is quickly and easily configured using ClockBuilder Pro™ software. ClockBuilder Pro assigns a custom part number for each unique configuration. Devices ordered with custom part numbers are factory-programmed free of charge, making it easy to get a custom clock uniquely tailored for each application. Using the Si5332-AM's I²C interface, the device may be user-configured at power-up or NVM programmed using the ClockBuilder Pro Field Programmer.

Applications:

- ADAS ECUs
- Automotive Networking/Gateways
- Digital Cockpit/IVI
- Lidar/Radar Sensors
- Automated Driving ECUs
- Camera/Vision Systems

KEY FEATURES

- Any-Frequency 6/8/12-output programmable clock generators
- AEC-Q100 qualified
- AEC-Q006 qualified
- Automotive Grade 2: -40 to +105 °C
- SmartClock health monitoring and fault detection features
- Offered in three different package sizes, supporting different combinations of output clocks and user configurable hardware input pins
 - 32-pin QFN, up to 6 outputs
 - 40-pin QFN, up to 8 outputs
 - 48-pin QFN, up to 12 outputs
- MultiSynth technology enables any-frequency synthesis on any output up to 250 MHz
- Integer dividers up to 333.33 MHz
- Highly configurable output path featuring a cross point mux
 - Up to three independent fractional synthesis output paths
 - Up to five independent integer dividers
- Input frequency range:
 - External crystal: 16 to 50 MHz
 - Differential clock: 10 to 250 MHz
 - LVCMOS clock: 10 to 170 MHz
- Output frequency range:
 - Differential: 5 to 333.33 MHz
 - LVCMOS: 5 to 170 MHz
- PCIe Gen 1/2/3/4/5 compliant
- User-configurable clock output signal format per output: LVDS, LVPECL, HCSL, LVCMOS
- Down and center spread spectrum
- RoHS-6 compliant
- [Si5332-AM1/2/3 Family Reference Manual](#)

Table of Contents

1. Features List	4
2. Ordering Guide	5
3. Functional Description	6
3.1 Functional Block Diagrams	7
3.2 Modes of Operation	9
3.2.1 Initialization	9
3.3 Frequency Configuration	9
3.4 Inputs	10
3.4.1 External Reference Input (XA/XB)	10
3.4.2 Input Clocks	10
3.4.3 Input Selection	10
3.5 Outputs	11
3.5.1 Output Signal Format	11
3.5.2 Differential Output Terminations	12
3.5.3 LVCMOS Output Terminations	16
3.5.4 LVCMOS Output Signal Swing	16
3.5.5 LVCMOS Output Polarity	16
3.5.6 Output Enable/Disable	16
3.5.7 Differential Output Configurable Skew Settings	16
3.5.8 Synchronous Output Disable Feature	17
3.6 Spread Spectrum	17
3.7 Universal Hardware Pins	17
3.8 Custom Factory Preprogrammed Parts	19
3.9 I ² C Serial Interface	19
3.10 In-Circuit Programming	19
3.11 Minimizing Power Consumption	20
4. Register Map	21
5. Electrical Specifications	22
6. Pin Descriptions	35
6.1 Pin Descriptions (48-QFN)	35
6.2 Pin Descriptions (40-QFN)	40
6.3 Pin Descriptions (32-QFN)	45
7. Package Outline	49
7.1 Si5332-AM3 7x7 mm 48-QFN Package Diagram	49
7.2 Si5332-AM2 6x6 mm 40-QFN Package Diagram	51
7.3 Si5332-AM1 5x5 mm 32-QFN Package Diagram	52
8. PCB Land Pattern	54

8.1 7x7 mm 48-QFN Land Pattern54
8.2 6x6 mm 40-QFN Land Pattern56
8.3 5x5 mm 32-QFN Land Pattern58
9. Top Marking	60
10. Revision History	61

1. Features List

- Any-Frequency 6/8/12-output programmable clock generators
- Offered in three different package sizes, supporting different combinations of output clocks and user configurable hardware input pins
 - 32-pin QFN, up to 6 outputs
 - 40-pin QFN, up to 8 outputs
 - 48-pin QFN, up to 12 outputs
- MultiSynth technology enables any-frequency synthesis on any output up to 250 MHz
- Integer output frequencies up to 333.33 MHz
- Highly configurable output path featuring a cross point mux
 - Two independent fractional synthesis output paths
 - Up to five independent integer dividers
- Input frequency range:
 - External crystal: 16 to 50 MHz
 - Differential clock: 10 to 250 MHz
 - LVCMOS clock: 10 to 170 MHz
- Output frequency range:
 - Differential: 5 to 333.33 MHz
 - LVCMOS: 5 to 170 MHz
- SmarClock health monitoring and fault detection capability of input sources
- Primary and redundant input reference sources
- AlwaysOn sources clock outputs within +/-5% if primary/secondary sources fault
- User-configurable clock output signal format per output: LVDS, LVPECL, HCSL, LVCMOS
- 190 fs RMS phase jitter
- PCIe Gen1/2/3/4/5, common clocks, and SRIS compliant
- 1.8 V, 2.5 V, 3.3 V core VDD
- Adjustable output-output delay
- Independent glitchless on-the-fly output frequency changes
- Very low power consumption
- Independent output supply pins for each bank of outputs:
 - 1.8 V, 2.5 V, or 3.3 V differential
 - 1.5 V, 1.8 V, 2.5 V, 3.3 V LVCMOS
- Programmable spread spectrum
 - Down and center spread from 0.1% to 2.5% in 0.01% steps from 30 kHz to 33 kHz
- Integrated power supply filtering
- Serial interface: I²C
- ClockBuilder Pro software utility simplifies device configuration and assigns custom part numbers
- AEC-Q100 qualified
- AEC-Q006 qualified
- Automotive grade 2 temperature range: -40 to +105 °C
- RoHS-6 compliant

2. Ordering Guide

In-System Programmable Devices

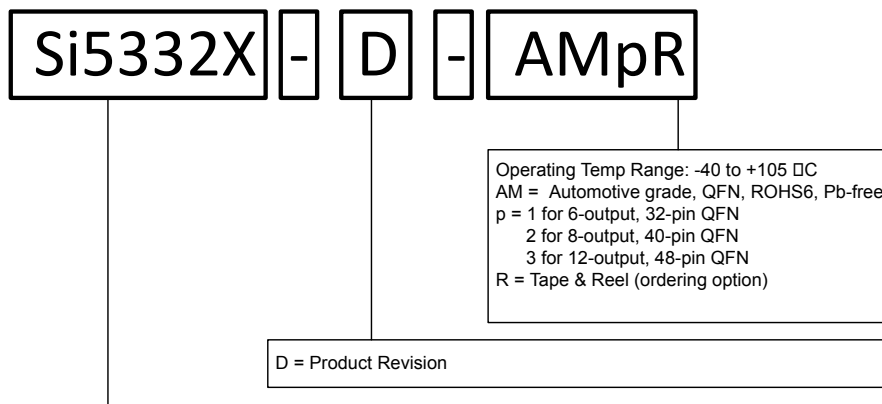

Ordering Part Number	Frequency Synthesis Mode	Input Type	Output Clock Frequency Range	Operating Temperature Range
Si5332A	Integer and Fractional mode	External crystal or Clock	5MHz - 333.33MHz	-40 to +105C
Si5332B	Integer and Fractional mode		5MHz - 200MHz	
Si5332C	Integer mode only		5MHz - 333.33MHz	
Si5332D	Integer mode only		5MHz - 200MHz	

Preprogrammed Devices Using a ClockBuilder Pro Configuration File

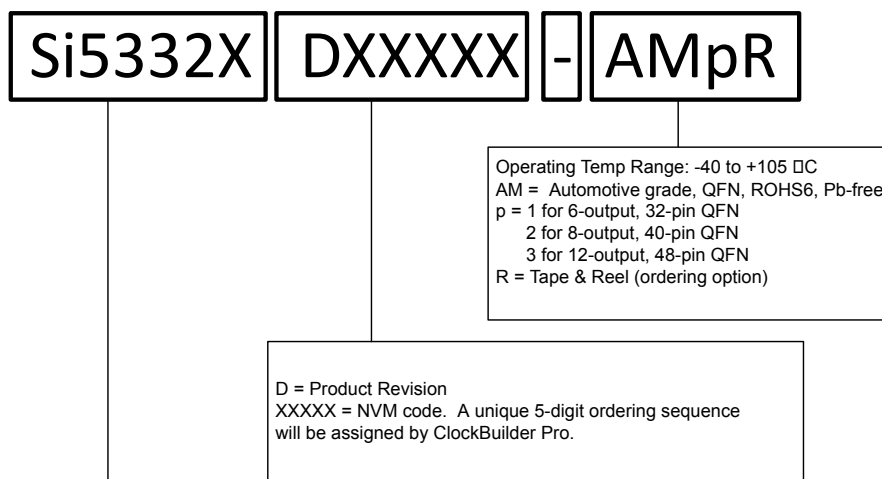

Ordering Part Number	Frequency Synthesis Mode	Input Type	Output Clock Frequency Range	Operating Temperature Range
Si5332A	Integer and Fractional mode	External crystal or Clock	5MHz - 333.33MHz	-40 to +105C
Si5332B	Integer and Fractional mode		5MHz - 200MHz	
Si5332C	Integer mode only		5MHz - 333.33MHz	
Si5332D	Integer mode only		5MHz - 200MHz	

Figure 2.1. Orderable Part Number Guide

3. Functional Description

The Si5332-AM is an automotive Grade 2 high-performance, low-jitter clock generator capable of synthesizing up to 12 user-programmable clock frequencies up to 333.33 MHz. The device supports free-run operation using an external crystal or it can lock to an external clock signal. The output drivers support up to 12 differential clocks or 24 LVCMOS clocks, or a combination of both. The output drivers are configurable to support common signal formats, such as LVPECL, LVDS, HCSL, and LVCMOS. VDDO pins are provided for versatility, which can be set to 3.3 V, 2.5 V, 1.8 V or 1.5 V (CMOS only) to power the multi-format output drivers. The core voltage supply (VDD) accepts 3.3 V, 2.5 V, or 1.8 V and is independent from the output supplies (VDDOxs). Using its two-stage synthesis architecture and patented high-resolution low-jitter MultiSynth technology, the Si5332 can generate an entire clock tree from a single device.

The Si5332-AM combines a wideband PLL with next generation MultiSynth technology to offer the industry's highest output count high performance programmable clock generator with attainable jitter performance below 200 fs RMS. The PLL locks to either an external 16-50 MHz crystal or to an external clock (CLKIN_2/CLKIN_2# or CLKIN_3/CLKIN_3#) for generating synchronous clocks. In clock generator mode, the oscillator frequency is multiplied by the PLL and then divided down either by an integer divider or MultiSynth for fractional synthesis.

The Si5332-AM features user-defined universal hardware pins which can be configured in the ClockBuilder Pro software utility. Universal hardware pins can be used for input functions, such as OE, spread spectrum enable, input clock selection, output frequency selection, I²C address select, or RESET. Users can also assign a universal hardware pin as an LOS output or as a FOOF output.

The device provides the option of storing a user-defined clock configuration in its non-volatile memory (NVM), which becomes the default clock configuration at power-up. To enable in-system programming, a power up mode is available through OTP, which powers up the chip in an OTP defined default mode but with no outputs enabled. This allows a host processor to first write a user defined subset of the registers and then restart the power-up sequence to activate the newly programmed configuration without re-downloading the OTP.

SmartClock health monitoring and fault detection features are available through the LOS, FOOF, and CLK_SEL features using the Universal HW pins defined during ClockBuilder Pro project file development. When using these features, both primary and backup input reference sources are used. The Si5332-AM monitors the health of the input source to the PLL, and will provide a signal output to a system safety manager or ASIL rated MCU if a loss of signal or out-of-frequency fault occurs. With an external MCU or equivalent, the device can then migrate input reference from the primary source to the secondary source, ensuring clock outputs continue to be supplied to endpoint devices. In the event of primary and redundant input reference failure, AlwaysOn mode allows the output clocks to continue operating within +/-5% of the desired output frequency. Further details on these features, as well as system implementations, are available in the application note, "[AN1292: Si5332-AM Fault Detection and Monitoring](#)".

3.1 Functional Block Diagrams

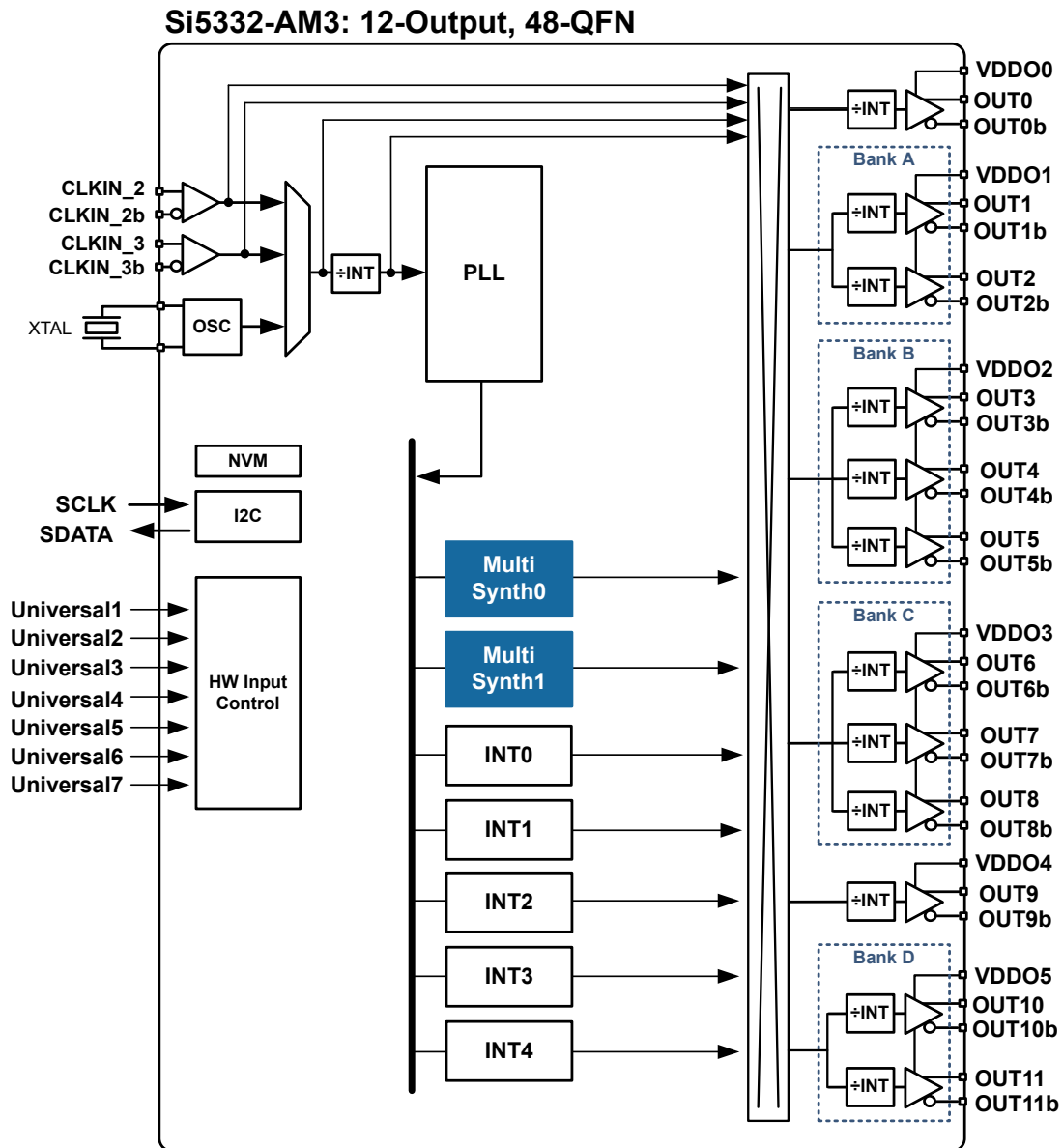

Figure 3.1. Block Diagram for 12-Output Si5332 in 48-QFN

The Si5332-AM2 48-QFN features:

- Up to 12 differential clock outputs with six VDDO pins.
- Seven user-configurable Universal HW pins, defined using ClockBuilder Pro.

Si5332-AM2: 8-Output, 40-QFN



Figure 3.2. Block Diagram for 8-Output Si5332 in 40-QFN

The Si5332-AM2 40-QFN features:

- Up to eight differential clock outputs with six VDDO pins.
- Seven user-configurable Universal HW pins, defined using ClockBuilder Pro.

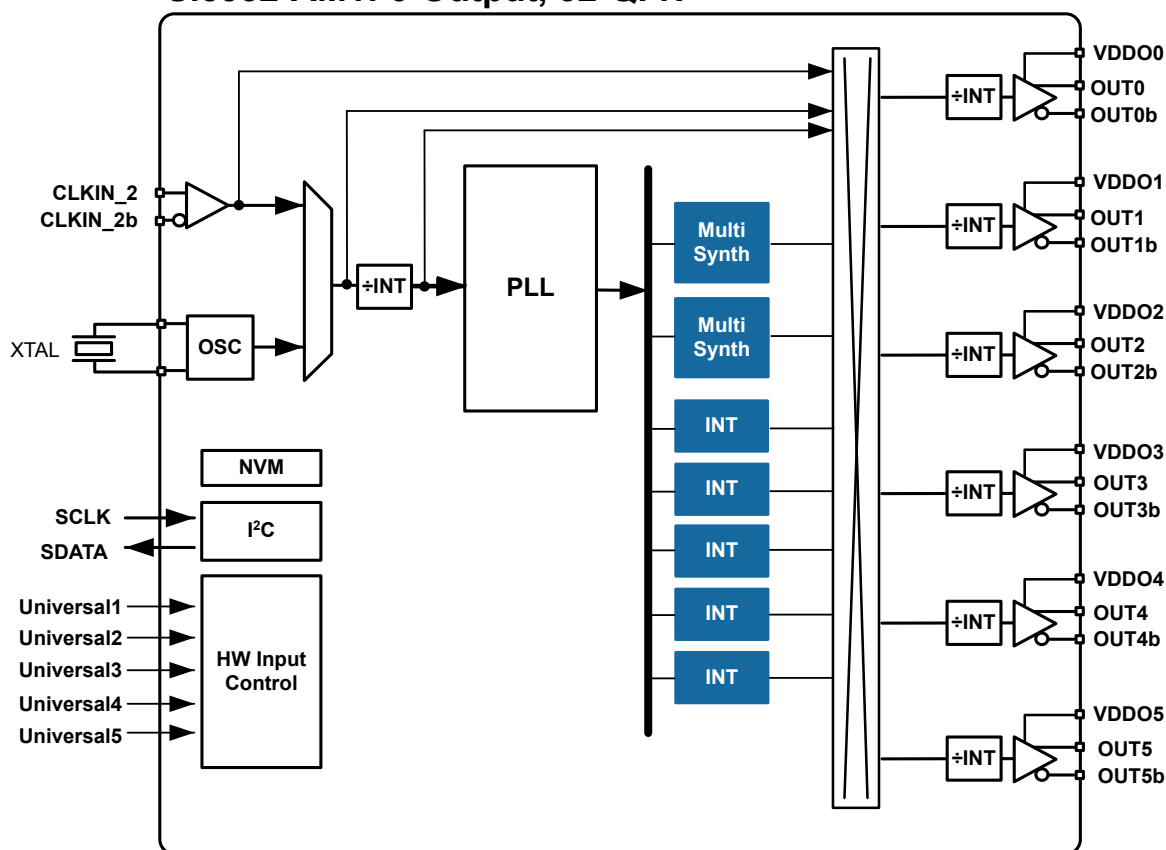
Si5332-AM1: 6-Output, 32-QFN**Figure 3.3. Block Diagram for 6-Output Si5332 in 32-QFN**

The Si5332-AM1 32-QFN features:

- Up to six differential clock outputs with individual VDDO.
- Five user-configurable Universal HW pins, defined using ClockBuilder Pro.

3.2 Modes of Operation

The Si5332-AM supports both free-run and synchronous modes of operation. The default mode selection is set in ClockBuilder Pro. Alternatively, two universal hardware pins can be defined as CLKIN_SEL[1:0] to select between a crystal or clock input. There is also the option to select the input source via the serial interface by writing to the input select register.

3.2.1 Initialization

When power is applied, the device begins an initialization period where it downloads default register values and configuration data from NVM and performs other initialization tasks. Communicating with the device through the serial interface is possible once this initialization period is complete. The clock outputs will be squelched until the device initialization is done.

3.3 Frequency Configuration

The phase-locked loop is fully integrated and does not require external loop filter components. Its function is to phase lock to the selected input and provide a common synchronous reference to the high-performance MultiSynth fractional or integer dividers.

A cross point mux connects any of the MultiSynth divided frequencies or INT divided frequencies to individual output drivers or banks of output drivers. Additional output integer dividers provide further frequency division by an integer from 1 to 63. The frequency configuration of the device is programmed by setting the input dividers (P), the PLL feedback fractional divider (M_n/M_d), the MultiSynth fractional dividers (N_n/N_d), and the output integer dividers (R). Skyworks' Clockbuilder Pro configuration utility determines the optimum divider values for any desired input and output frequency plan.

3.4 Inputs

The Si5332 requires an external 16–50 MHz crystal at its XA/XB pins to operate in free-run mode, or an external input clock (CLKIN_2/CLKIN_2# or CLKIN_3/CLKIN_3#) for synchronous operation. An external crystal is not required in synchronous mode.

3.4.1 External Reference Input (XA/XB)

An external crystal (XTAL) is used in combination with the internal oscillator (OSC) on Si5332-AM to produce a low jitter reference for the PLL when operating in the free-run mode. The [Si5332-AM1/2/3 Automotive Grade Device Reference Manual](#) provides additional information on PCB layout recommendations for the crystal to ensure optimum jitter performance. Refer to [Table 5.4 External Crystal Input Specification on page 25](#) for crystal specifications.

For free-running operation, the internal oscillator can operate from a low-frequency fundamental mode crystal (XTAL) with a resonant frequency of 16 to 50 MHz. A crystal can easily be connected to pins XA and XB without external components, as shown in the figure below. Internal loading capacitance (CL) values from 2.5 pf to 21.5 pf can be selected via register settings. Alternatively, an external CL can be used along with the internal CL. See the [Si5332-AM1/2/3 Automotive Grade Device Reference Manual](#) for more information on calculating crystal capacitive loading values.

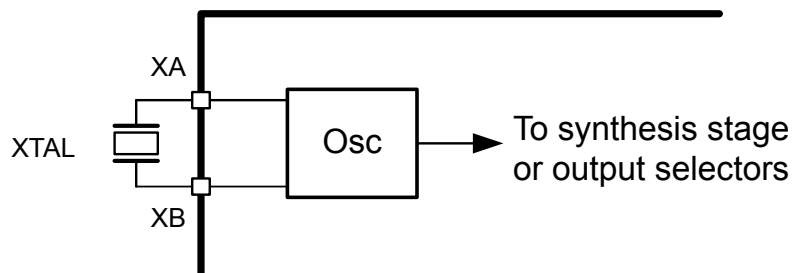

Figure 3.4. External Reference Input (XA/XB)

3.4.2 Input Clocks

An input clock is available to synchronize the PLL when operating in synchronous mode. This input can be configured as LVPECL, LVDS or HCSL differential, or LVCMOS. The recommended input termination schemes are shown in the [Si5332-AM1/2/3 Family Reference Manual](#). Input clocks defined as "Unused" in CBPro can be left unconnected.

3.4.3 Input Selection

The active clock input is selected by register control, or by defining two universal input pins as CLKIN_SEL[1:0] in ClockBuilder Pro. A register bit determines input selection as pin or register selectable. If there is no clock signal on the selected input at power-up, the device will not generate output clocks.

In a typical application, the Si5332-AM reference input is configured immediately after power-up and initialization. If the device is switched to another input more than ± 1000 ppm offset from the initial input, the device must be recalibrated manually to the new frequency, temporarily turning off the clock outputs. After the VCO is recalibrated, the device will resume producing clock outputs. If the selected inputs are within ± 1000 ppm, any phase error difference will propagate through the device at a rate determined by the PLL bandwidth. Hitless switching and phase build-out are not supported by the Si5332-AM.

SmartClock health monitoring and fault detection features utilize the CLK_SEL pins. ClockBuilder Pro helps guide users through the steps needed to assign these pins.

3.5 Outputs

The Si5332-AM supports up to 12 differential output drivers. Each output can be independently configured as a differential pair or as dual LVCMOS outputs. The 8-output and 12-output devices feature banks of outputs, with each bank sharing a common VDDO.

Table 3.1. Clock Outputs

Device/Package	Maximum Outputs
Si5332-AM1 (32-QFN)	6 Differential, 12 LVCMOS
Si5332-AM2 (40-QFN)	8 Differential, 16 LVCMOS
Si5332-AM3 (48-QFN)	12 Differential, 24 LVCMOS

The output stage is different for each of the three versions of Si5332.

- The 6-output device features individual VDDO pins for each clock output. Each clock output can be sourced from MultiSynth0, MultiSynth1, the input reference clock, or one of the five INT dividers through the cross point mux.
- The 8-output device includes four clock outputs with dedicated VDDO pins, each of which can be sourced from MultiSynth0, MultiSynth1, the input reference clock, or one of the five INT dividers through the cross point mux. The remaining four clock outputs are divided into Bank A and Bank B. Each Bank of outputs can be sourced from MultiSynth0, MultiSynth1, the input reference clock, or one of the five INT dividers through the cross point mux. The outputs within each of the two Banks share a common VDDO pin.
- The 12-output device includes two clock outputs with dedicated VDDO pins, each of which can be sourced from MultiSynth0, MultiSynth1, the input reference clock, or one of the five INT dividers through the cross point MUX. The remaining ten clock outputs are divided into Bank A, Bank B, Bank C, and Bank D. Each Bank of outputs can be sourced from MultiSynth0, MultiSynth1, the input reference clock, or one of the five INT dividers through the cross point MUX. The outputs within each of the four Banks share a common VDDO pin.

Individual output banks can be configured to supply buffered copies of the input reference clock for all outputs within the bank.

Individual integer output dividers (R) allow the generation of additional synchronous frequencies. These integer dividers are configurable as divide by 1 (default) through 63.

3.5.1 Output Signal Format

The differential output swing and common mode voltage are compatible with a wide variety of signal formats including HCSL, LVDS and LVPECL. In addition to supporting differential signals, any of the outputs can be configured as LVCMOS drivers, enabling the device to support both differential and single-ended clock outputs. Output formats can be defined in ClockBuilder Pro or via the serial interface.

3.5.2 Differential Output Terminations

LVDS Driver Termination

For a general LVDS interface, the recommended value for the differential termination impedance (Z_T) is between $90\ \Omega$ and $132\ \Omega$. The actual value should be selected to match the differential impedance (Z_0) of the transmission line. A typical point-to-point LVDS design uses a $100\ \Omega$ parallel resistor at the receiver and a $100\ \Omega$ differential transmission-line environment. To avoid any transmission-line reflection issues, surface mount the components and place them as close to the receiver as possible. The standard LVDS termination schematic as shown in [Figure 3.5 Standard LVDS Termination on page 12](#) can be used with either type of output structure. [Figure 3.6 Optional LVDS Termination on page 12](#), which can also be used with both output types, is an optional termination with center tap capacitance to help filter common mode noise. The capacitor value should be approximately 0.01 to $0.1\ \mu\text{F}$. If using a non-standard termination, please contact Skyworks to confirm if the output structure is current source or voltage source type. In addition, since these outputs are LVDS compatible, the input receiver's amplitude and common-mode input range should be verified for compatibility with the output.

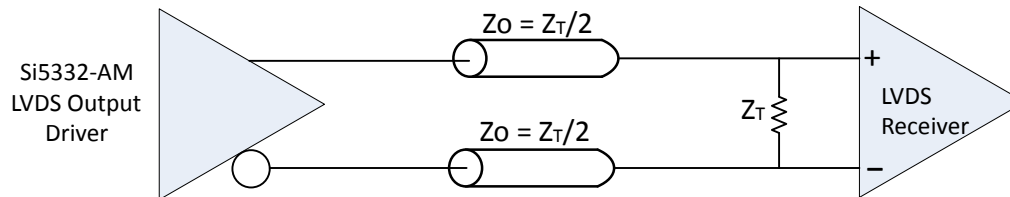

Figure 3.5. Standard LVDS Termination

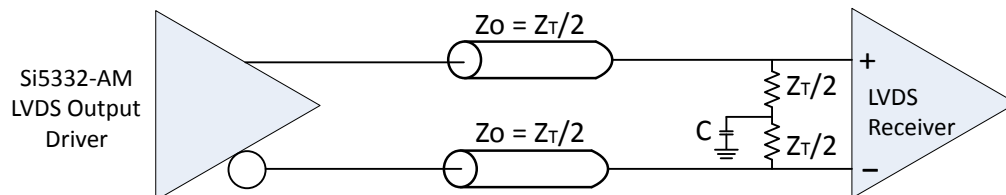

Figure 3.6. Optional LVDS Termination

Termination for 3.3 V LVPECL Outputs

The clock layout topology shown below is a typical termination for LVPECL outputs. The two different layouts mentioned are recommended only as guidelines. The differential outputs generate ECL/LVPECL compatible outputs. Therefore, terminating resistors (DC current path to ground) or current sources must be used for functionality. These outputs are designed to drive $50\ \Omega$ transmission lines. Use matched impedance techniques to maximize operating frequency and minimize signal distortion. [Figure 3.7 3.3 V LVPECL Output Termination, Option 1 on page 13](#) and [Figure 3.8 3.3 V LVPECL Output Termination, Option 2 on page 13](#) show two different layouts. Other suitable clock layouts may exist, but it is recommended that the board designers simulate to guarantee compatibility across all printed circuit and clock component process variations.



Figure 3.7. 3.3 V LVPECL Output Termination, Option 1



Figure 3.8. 3.3 V LVPECL Output Termination, Option 2

Termination for 2.5 V LVPECL Outputs

Figure 3.9 2.5 V LVPECL Termination Example, Option 1 on page 14 and Figure 3.10 2.5 V LVPECL Termination Example, Option 2 on page 14 show examples of termination for the 2.5 V LVPECL driver option. These terminations are equivalent to terminating 50 Ω to VDDO – 2 V. For VDDO = 2.5 V, the VDDO – 2 V is very close to ground level. The R3 in Figure 3.10 2.5 V LVPECL Termination Example, Option 2 on page 14 can be optionally eliminated using the termination shown in Figure 3.9 2.5 V LVPECL Termination Example, Option 1 on page 14.



Figure 3.9. 2.5 V LVPECL Termination Example, Option 1

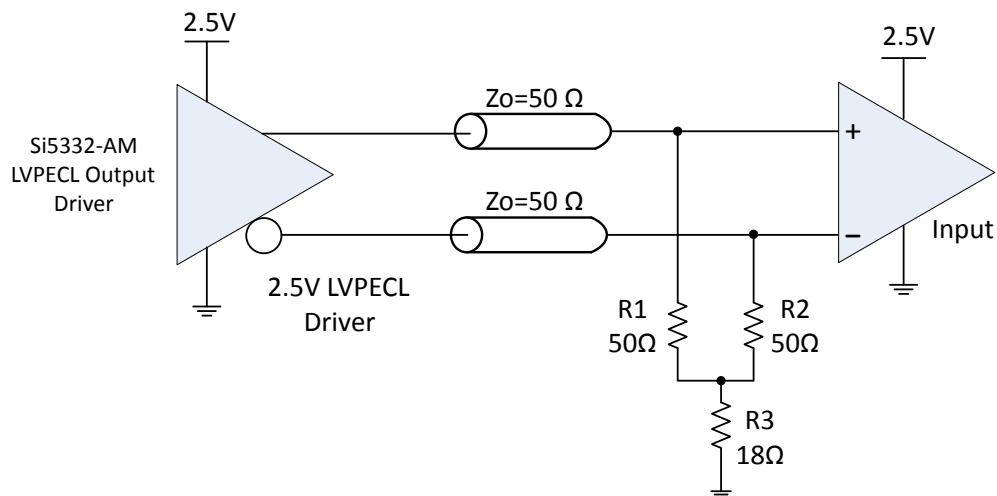

Figure 3.10. 2.5 V LVPECL Termination Example, Option 2

Termination for HCSL Outputs

The Si5332-AM HCSL driver option integrates termination resistors to simplify interfacing to an HCSL receiver. The HCSL driver supports both 100 Ω and 85 Ω transmission line options. This configuration option may be specified using ClockBuilder Pro or via the device I²C interface.

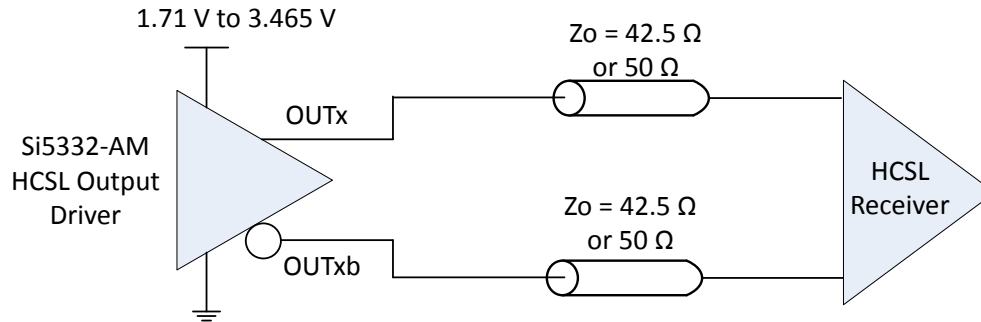

Figure 3.11. HCSL Internal Termination Mode



Figure 3.12. HCSL External Termination Mode

3.5.3 LVCMOS Output Terminations

LVCMOS outputs can be dc-coupled, as shown in the figure below.



Figure 3.13. LVCMOS Output Termination Example, Option 1



Figure 3.14. LVCMOS Output Termination Example, Option 2

The Si5332-AM features complementary LVCMOS driver options on all outputs. Skyworks recommends the use of complementary LVCMOS output drivers for all single-ended clock outputs in order to minimize unwanted emissions. Further details about using complementary LVCMOS output drivers, and the positive effects in CISPR25 Class4 and Class5 testing results, can be found in "[AN1237: Si5332 Design Guidelines for Minimizing EMI](#)".

3.5.4 LVCMOS Output Signal Swing

The signal swing (V_{OL}/V_{OH}) of the LVCMOS output drivers is set by the voltage on the VDDO pin for the respective bank.

3.5.5 LVCMOS Output Polarity

When a driver is configured as an LVCMOS output it generates a clock signal on both pins (OUTx and OUTxb). The LVCMOS outputs, OUTx and OUTxb, can be configured in CBPro to be either in-phase or complementary (180 degrees out of phase).

3.5.6 Output Enable/Disable

The universal hardware input pins can be programmed to operate as output enable (OEB), controlling one or more outputs. Pin assignment is done using ClockBuilder Pro. An output enable pin provides a convenient method of disabling or enabling the output drivers. When the output enable pin is held high all designated outputs will be disabled. When held low, the designated outputs will be enabled. Outputs in the enabled state can be individually disabled through register control.

3.5.7 Differential Output Configurable Skew Settings

Skew on the differential outputs can be independently configured. The skew is adjustable in 35 ps steps across a range of 245 ps.

3.5.8 Synchronous Output Disable Feature

Output clocks are always enabled and disabled synchronously. The output will wait until a clock period has completed before the driver is disabled. Similarly, outputs are synchronously enabled. This prevents unwanted runt pulses from occurring when disabling or enabling an output.

3.6 Spread Spectrum

To help reduce electromagnetic interference (EMI), the Si5332-AM supports spread spectrum modulation. The output clock frequencies can be modulated to spread energy across a broader range of frequencies, lowering system EMI. The Si5332-AM implements spread spectrum using its patented MultiSynth technology to achieve previously unattainable precision in both modulation rate and spreading magnitude. Spread spectrum can be configured in ClockBuilder Pro to be enabled.

The Si5332-AM features both center and down spread spectrum modulation capability, from 0.1% to 2.5%. Each MultiSynth is capable of generating an independent spread spectrum clock. The feature is enabled using a user-defined universal hardware input pin or via the device I²C interface. Spread spectrum can only be applied to an output clock derived from a MultiSynth fractional divider (up to 250 MHz) since spread spectrum clock generation is performed in the MultiSynth fractional dividers. The Si5332-AM features two independent MultiSynth dividers enabling the device to provide two independent spread profiles simultaneously to the clock output banks.

Spread spectrum is commonly used for 100 MHz PCI Express clock outputs. To comply with the spread spectrum specifications for PCI Express, set the spreading frequency to a maximum of 33 kHz and –0.5% down spread. A universal hardware input pin can be configured to toggle spread spectrum on/off.

3.7 Universal Hardware Pins

Universal hardware pins are user-configurable control pins that can have one or more of the functions listed below assigned to them using ClockBuilder Pro.

Universal hardware pins can be utilized for the following functions:

Table 3.2. Universal Hardware Pins

Description	Function
SSEN_EN0	Spread spectrum enable on MultiSynth0 (N0).
SSEN_EN1	Spread spectrum enable on MultiSynth0 (N1).
FS_INTx	Used to switch an integer output divider frequency from frequency A to frequency B.
FS_MSx	Used to switch a MultiSynth output divider output from frequency and/or change spread spectrum profile.
OE	Output enable for one or more outputs.
I ² C address select	Sets the LSB of the I ² C address to either 0 or 1.
CLKIN_SEL[1:0]	Selects between crystal or clock inputs.
LOS	Loss Of Signal (LOS) Output: Asserts if reference input frequency signal drops below configured input frequency or is no longer detected.
FOOF	Fast Out Of Frequency (FOOF) Output: Asserts if PLL can no longer track input reference clock.

Spread Spectrum Enable Pins (SSEN[1:0])

SSEN_EN[1:0] pins are input pins that enable/disable spread spectrum on all outputs that correspond to MultiSynth0 or MultiSynth1, respectively. The change in frequency or spread spectrum will be instantaneous and may not be glitch-free.

Table 3.3. SSEN_EN Pin Selection Table

SSEN_ENx	
0	Spread Spectrum disabled on MultiSynthx
1	Spread Spectrum enabled on MultiSynthx

Output Frequency Select Pins

There are five integer dividers, one corresponding to each of the five output banks. Using ClockBuilder Pro, a universal hardware input pin can be assigned for each integer divider, providing capability to select between two different pre-programmed divide values. Divider values of every integer from 8 to 255 are available in ClockBuilder Pro for each integer divider.

Table 3.4. FS_INT Pin Selection Table

FS_INTX	Output Frequency from INTx
0	Frequency A, as defined in ClockBuilder Pro
1	Frequency B, as defined in ClockBuilder Pro

Output Enable

A universal hardware input pin can be defined to control output enable of a differential output, a bank of differential outputs, or as a global output enable pin controlling all outputs. Upon de-assertion of an OE pin, the corresponding output will be disabled within 2-6 clock cycles. Asserting an OE pin from disable to enable will take <20 μ s for the output to have a clean clock.

Output enabled/disabled for LVCMOS are done in pairs. Each differential buffer True and Compliment output can generate an LVCMOS clock and the OE pin associated with the True and Compliment output buffer will control the respective LVCMOS pair.

For example: If DIFF0 is configured to be SE1 and DIFF0# is configured to be SE2 and OE1 is the associated OE pin, de-asserting the OE1 pin will disable both SE1 and SE2 outputs. The disable and enable of the outputs to a known state is glitch free.

I²C Address Pin

This pin sets the LSB of the 7-bit I²C address. For example, if the I²C address is 6Ah, setting this pin high will set the I²C address to 6Bh.

CLKIN_SEL[1:0] Pins

These pins are used to set the input source clock between the input clock channels (Crystal, CLKIN_2/CLKIN_2# or CLKIN_3/CLKIN_3#). Upon switching the input clock source, the output will not be glitch free. It is intended for the user to set this pin to a known state before the system is powered up or have the receiver address any unintended output signals when switching to a different input source clock.

The SmartClock health monitoring and fault detection features utilize the CLK_SEL pins. ClockBuilder Pro guides users through the steps needed to assign these pins. When using Si5332-AM2/3, one of the Si5332-AM outputs should be used as an input source. Additional details on implementing the health monitoring and fault detection features can be found in the "[Si5332-AM1/2/3 Automotive Grade Device Reference Manual](#)" and "[AN1292: Si5332-AM Fault Detection and Monitoring](#)".

LOS (Loss of Signal) Output

LOS is a feature that can be implemented during configuration file development using ClockBuilder Pro on a customized device. LOS is not available on the generic volatile I²C programmable devices. The LOS indicator is used to check for the presence of an input reference source (crystal or clock). LOS will assert when the reference source frequency drops below the configured input reference frequency or is no longer detected.

LOS pin is active low open drain output. Requires external pull-up resistor to device VDD Core voltage. Resistor value of 1 kΩ or greater.

FOOF (Fast Out of Frequency) Output

FOOF is a SmartClock feature that indicates the PLL can no longer track the input reference clock. This can be the result of input reference clock failure or other PLL fault. The FOOF output can be connected to a system safety manager IC or ASIL-B/D MCU to alert the system of a reference clock fault. If a fault is detected and the FOOF is asserted, the system safety manager IC or ASIL-B/D MCU can subsequently switch from the primary input source (that has faulted) to a secondary, back-up source so that the Si5332-AM continues sourcing output clocks. For further detailed information on how to implement this function, please refer to "[AN1292: Si5332-AM Fault Detection and Monitoring](#)".

LOS pin is active low open drain output. Requires external pull-up resistor to device VDD Core voltage. Resistor value of 1 kΩ or greater.

3.8 Custom Factory Preprogrammed Parts

Custom pre-programmed parts can be ordered corresponding to a specific configuration file generated using the ClockBuilder Pro software utility. Skyworks writes the configuration file into the device prior to shipping. Use the [ClockBuilder Pro](#) custom part number wizard to quickly and easily generate a custom part number for your ClockBuilder Pro configuration file. A factory pre-programmed part will generate clocks at power-up.

In less than three minutes, you will be able to generate a custom part number with a detailed data sheet addendum matching your design's configuration. Once you receive the confirmation email with the data sheet addendum, simply place an order with your local Skyworks sales representative. Samples of your pre-programmed device will ship within two weeks.

3.9 I²C Serial Interface

The Si5332-AM is compatible with Rev 6 of the I²C specification, including Standard, Fast, and Fast+ modes.

Configuration and operation of the Si5332-AM can be controlled by reading and writing registers using the I²C. Communication with a 1.8 V, 2.5 V, or 3.3 V host is supported consistent with SDA, SCLK pin usage as described in the device [Pin Description](#) tables. See the [Si5332-AM1/2/3 Family Reference Manual](#) for details.

3.10 In-Circuit Programming

The Si5332-AM is in-system configurable using the I²C interface by the following two methods:

- *In-circuit configuration of device registers after power-up.* With this method, changes to volatile register memory can be done as required to produce the desired outputs. This does not alter internal NVM; therefore, register memory changes are lost at power-down. Refer to the [Si5332-AM1/2/3 Family Reference Manual](#) available on our web site for details.

Note: Universal input/output pin configurations, or pin configuration changes, can't be performed when using this method of device configuration.

- *In-circuit re-configuration of internal NVM.* Writing to internal NVM requires the use of the CBPro Field Programmer (CBPROG-DON-GL) and CBPro software. See [UG286: ClockBuilderPro Field Programmer Kit User's Guide](#), available on the Skyworks website for more information.
- VDD core voltages (VDD_DIG, VDDA, VDD_XTAL) must be 3.3 V for in-circuit NVM programming. Using VDD core voltage lower than 3.3 V (i.e., 2.5 V or 1.8 V) will not support reliable in-circuit NVM programming.

3.11 Minimizing Power Consumption

The Si5332-AM clock generator products are designed to provide a high level of flexibility and programmability, while achieving very low jitter performance. To ensure the 125 °C maximum junction temperature limit (T_{JMAX}) is not exceeded, overall power consumption of the device must be limited to the maximum specifications noted in [Table 5.2 DC Characteristics on page 23](#).

ClockBuilder Pro provides power consumption and T_J estimates to help with power estimation and budgeting as a configuration file is being developed. If the maximum power consumption limit is exceeded, ClockBuilder Pro will provide a warning to the user. Skyworks recommends the following guidelines:

To minimize power consumption:

- Use 1.8 V VDD and/or VDDO instead of 2.5 V or 3.3 V whenever possible.
- For differential clock outputs, use LVDS output drivers instead of LVPECL or HCSL.
- For HCSL clock outputs:
 - Select 100 Ω impedance driver instead of 85 Ω
 - Select external termination instead of internal termination
- For single-ended clock outputs
 - Use the lowest frequency option available for your design. Lower frequencies consumes lower output driver current.
 - Use the lowest capacitive loading available for your design. Lower capacitive loading consumes lower output driver current.
 - When two outputs of the same frequency are needed, select a dual-complementary CMOS output driver instead of two independent single-CMOS output drivers.

Skyworks always recommends that users develop a configuration file in ClockBuilder Pro and assign a customized part number. Users who elect to use the “blank” ordering option and program the device in-system must first check the desired configuration in ClockBuilder Pro to ensure the maximum power consumption limits are not exceeded. That is the only way to ensure the maximum power consumption limits are not exceeded, and therefore, meets a 125 °C maximum junction temperature.

4. Register Map

Refer to the [Si5332-AM1/2/3 Family Reference Manual](#) for a complete list of register descriptions and settings.

5. Electrical Specifications

Table 5.1. Recommended Operating Conditions

($V_{DD} = V_{DDA} = V_{DD_DIG} = V_{DD_XTAL} = 1.8\text{ V to }3.3\text{ V }+5\%/-5\%$, $V_{DDO} = 1.8\text{ V }±5\%$, $2.5\text{ V }±5\%$, or $3.3\text{ V }±5\%$, $T_A = -40\text{ to }105\text{ }^{\circ}\text{C}$)

Parameter	Symbol	Test Condition	Min	Typ	Max	Units
Ambient Temperature	T_A		-40	25	105	$^{\circ}\text{C}$
Junction Temperature	T_{JMAX}		—	—	125	$^{\circ}\text{C}$
Core Supply Voltage	V_{DDA} , V_{DD_DIG} , V_{DD_xtal}		1.71	—	3.46	V
Output Driver Supply Voltage	V_{DDO}		1.42 ³	—	3.46	V

Note:

1. All minimum and maximum specifications are guaranteed and apply across the recommended operating conditions. Typical values apply at nominal supply voltages and an operating temperature of 25 $^{\circ}\text{C}$ unless otherwise noted.
2. All core voltages (V_{DD_DIG} , V_{DDA} , V_{DD_XTAL}) must be connected to the same voltage.
3. LVCMOS outputs only.

Table 5.2. DC Characteristics

($V_{DD} = V_{DDA} = V_{DD_DIG} = V_{DD_XTAL} = 1.8\text{ V to }3.3\text{ V }+5\%/-5\%$, $V_{DDO} = 1.8\text{ V }±5\%$, $2.5\text{ V }±5\%$, or $3.3\text{ V }±5\%$, $T_A = -40\text{ to }105\text{ }^{\circ}\text{C}$)

Parameter	Symbol	Test Condition		Min	Typ	Max	Units
Core Supply Current	I_{DD}			—	45	70	mA
Output Buffer Supply Current	I_{DDOx}	LVPECL Output ¹ @ 156.25 MHz		—	33	35	mA
		HCSL Output ¹ @ 100 MHz		—	20	22	mA
		LVDS Output ¹ @ 156.25 MHz		—	11	13	mA
		3.3 V VDDO LVCMOS ² output @ 170 MHz		—	16	19	mA
		2.5 V VDDO LVCMOS ² output @ 170 MHz		—	9	11	mA
		1.8 V VDDO LVCMOS ² output @ 170 MHz		—	7.5	8.5	mA
Total Power Dissipation	P_d	48-pin	Notes 3, 4	—	590	1550	mW
		40-pin	Notes 3, 4, 5	—	320	875	mW
		32-pin	Notes 3, 4, 6	—	270	720	mW

Note:

- Differential outputs terminated into a 100 Ω load.
- LVCMOS outputs measured into a 5 inch 50 Ω PCB trace with 4 pF load.

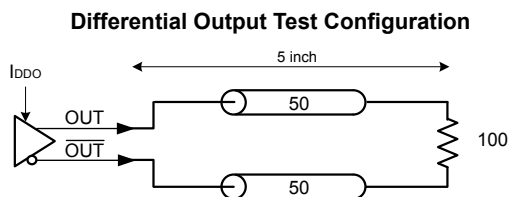

- ClockBuilderPro includes a power consumption indicator. Users should always enter the desired configuration into ClockBuilderPro to ensure the maximum power dissipation limits are not exceeded.
- If configurations exceed the Max Total Power Dissipation specifications, the maximum ambient temperature limit of 105 $^{\circ}\text{C}$ and maximum junction temperature limits of 125 $^{\circ}\text{C}$ are void.
- Si5332 40-pin test configuration: $V_{DD} = V_{DDA} = V_{DD} = 1.8\text{ V}$, 4 \times 2.5 V LVDS outputs enabled @ 156.25 MHz, 2 \times 1.8 V HCSL outputs enabled @ 100 MHz, 2 \times 3.3 V LVCMOS outputs enabled @ 25 MHz. . Excludes power in termination resistors.
- Si5332 32-pin test configuration: $V_{DD} = V_{DDA} = V_{DDI} = 1.8\text{ V}$, 2 \times 2.5 V LVDS outputs enabled @ 156.25 MHz, 2 \times 1.8 V HCSL outputs enabled @ 100 MHz. 2x 3.3 V LVCMOS outputs enabled @ 25 MHz. Excludes power in termination resistors.

Table 5.3. Clock Input Specifications(V_{DD} = V_{DDA} = V_{DD_DIG} = V_{DD_XTAL} = 1.8 V to 3.3 V +5%/-5%, V_{DDO} = 1.8 V ±5%, 2.5 V ±5%, or 3.3 V ±5%, T_A = -40 to 105 °C)

Parameter	Symbol	Test Condition	Min	Typ	Max	Units
Input Clock (AC-Coupled Differential Input Clock on CLKIN_2/CLKIN_2# or CLKIN_3/CLKIN_3#)						
Frequency	F _{IN}	Differential	10	—	250	MHz
Voltage Swing	V _{PP_DIFF} ³	Differential AC-coupled < 333.33 MHz	0.5	—	1.8	V _{PP_diff}
Slew Rate ^{1,2}	SR/SF	20-80%	0.75	—	—	V/ns
Duty Cycle	DC		40	—	60	%
Input Impedance	R _{IN}		10	—	—	kΩ
Input Capacitance	C _{IN}		2	3.5	6	pF
Input Clock (AC-Coupled LVCMOS Input Clock on CLKIN_2 or CLKIN_3)						
Frequency	F _{IN}		10	—	170	MHz
Input High Voltage	V _{IH}		0.8 × V _{DD}	—	—	V
Input Low Voltage	V _{IL}		—	—	0.2 × V _{DD}	V
Slew Rate ^{1,2}	SR/SF	20-80%	0.75	—	—	V/ns
Duty Cycle	DC		40	—	60	%
Input Capacitance	C _{IN}		2	3.5	6	pF
Input Clock (AC-Coupled Input Clock on CLKIN1)						
Frequency	F _{IN}		10	—	170	MHz
Voltage Swing				—	1	V _{PP}
Input Low Voltage	V _{IL}		—	—	0.2 × V _{DD}	V
Slew Rate ^{1, 2}	SR/SF	20-80%	0.75	—	—	V/ns
Duty Cycle	DC		40	—	60	%
Input Capacitance	C _{IN}		2	3.5	6	pF
Notes:						
1. Imposed for jitter performance.						
2. Rise and fall times can be estimated using the following simplified equation: $tr/tf_{80-20} = ((0.8 - 0.2) * V_{IN_Vpp_se}) / SR$.						
3. V _{PP_DIFF} = 2 × V _{PP_SINGLE-ENDED}						

Table 5.4. External Crystal Input Specification(V_{DD} = V_{DDA} = V_{DD_DIG} = V_{DD_XTAL} = 1.8 V to 3.3 V +5%/-5%, V_{DDO} = 1.8 V ±5%, 2.5 V ±5%, or 3.3 V ±5%, T_A = -40 to 105 °C)

Parameter	Symbol	Test Condition	Min	Typ	Max	Units
Crystal Frequency	F _{xtal}		16-50			MHz
Load Capacitance	C _L	16 - 30 MHz	6	12	20	pF
		31 - 50 MHz			10	pF
Shunt Capacitance	C _O	16 - 30 MHz	—	—	7	pF
		31 - 50 MHz	—	—	2	pF
ESR		16 - 30 MHz	—	—	50	Ω
		31 - 50 MHz	—	—	50	Ω
Max Crystal Drive Level	d _L		—	—	250	μW
Input Capacitance ¹	C _{IN}	Internal cap disabled	—	2.5	—	pF
		Internal cap enabled (per pad) ²	5	—	43	pF
Input Voltage	V _{XIN}		-0.3	—	1.3	V

Notes:

- Internal capacitance on the xtal input pads is programmable or can be disabled. Refer to section [3.4.1 External Reference Input \(XA/XB\)](#) for more detailed information.
- Refer to [Si5332-AM1/2/3 Family Reference Manual](#) for more information.

Table 5.5. Control Pins(V_{DD} = V_{DDA} = V_{DD_DIG} = V_{DD_XTAL} = 1.8 V to 3.3 V ±5%, T_A = -40 to 105 °C)

Parameter	Symbol	Test Condition	Min	Typ	Max	Units
Si5332 Control Input Pins (Inputx)						
Input Voltage	V _{IL}		-0.1	—	0.3 × V _{DD} ¹	V
	V _{IH}		0.7 × V _{DD} ¹	—	1.1 × V _{DD} ¹	V
Input Capacitance	C _{IN}		—	—	4	pF
Pull-up/down Resistance	R _{IN}		—	50	—	kΩ

Note:

- V_{DD} indicates all core voltages V_{DD_DIG}, V_{DDA}, and V_{DD_XTAL} which are required to all be using same nominal voltage.

Table 5.6. Differential Clock Output Specifications(V_{DD} = V_{DDA} = V_{DD_DIG} = V_{DD_XTAL} = 1.8 V to 3.3 V +5%/-5%, V_{DDO} = 1.8 V ±5%, 2.5 V ±5%, or 3.3 V ±5%, T_A = -40 to 105 °C)

Parameter	Symbol	Test Condition		Min	Typ	Max	Units
Output Frequency	f _{OUT}	Integer synthesis mode		5	—	333.33 ¹³	MHz
		Fractional synthesis mode		5	—	250	MHz
Duty Cycle	DC	Note 1		48	—	52	%
Output-Output Skew	T _{SK}	Within the same bank		—	—	30	ps
		Across banks		—	—	80	ps
Output Voltage Swing	V _{SEPP}	LVPECL		0.6	0.75	0.85	V _{PP}
		LVDS ¹⁰	1.8/2.5/3.3 V	0.3	0.375	0.45	V _{PP}
		HCSL		0.7	0.8	0.9	V _{PP}
Common Mode Voltage	V _{CM}	LVPECL		—	V _{DDO} -1.4	—	V
		LVDS	2.5/3.3 V	1.125	1.2	1.275	V
		LVDS	1.8 V	0.75	0.8	0.85	V
		HCSL		0.35	0.4	0.45	V
HCSL Edge Rate	Edgr	Notes 3, 5, 7		1	—	4.5	V/ns
HCSL Delta Tr	D _{tr}	Notes 5, 6, 11		—	—	155	ps
HCSL Delta Tf	D _{tf}	Notes 5, 6, 11		—	—	155	ps
HCSL Vcross Abs	V _{xa}	Notes 2, 4, 5, 6		250	—	550	mV
HCSL Delta Vcross	D _{vcrs}	Notes 5, 6, 10		—	—	140	mV
HCSL Vovs	V _{ovs}	Notes 5, 6, 8		—	—	V _{HIGH} +300	mV
HCSL Vuds	V _{uds}	Notes 5, 6, 9		—	—	V _{LOW} -300	mV
HCSL Vrng	V _{rng}	Notes 5, 6		V _{HIGH} -200	—	V _{LOW} +200	mV
Rise and Fall Times (20% to 80%)	t _R /t _F	LVDS (fast mode)	3.3 V or 2.5 V	150	200	350	ps
		LVDS (slow mode)	3.3 V or 2.5 V	350	530	620	ps
			1.8 V	150	225	350	ps
Rise and Fall Times (20% to 80%)	t _R /t _F	LVPECL		150	—	320	ps
		HCSL		—	—	420	ps

Parameter	Symbol	Test Condition	Min	Typ	Max	Units
-----------	--------	----------------	-----	-----	-----	-------

Notes:

1. Not in PLL bypass mode.
2. Measured at crossing point where the instantaneous voltage value of the rising edge of CLK equals the falling edge of CLK#.
3. Measure taken from differential waveform on a component test board. The edge (slew) rate is measured from -150 mV to +150 mV on the differential waveform. Scope is set to average because the scope sample clock is making most of the dynamic wiggles along the clock edge. Only valid for Rising clock and Falling Clock#. Signal must be monotonic through the Vol to Voh region for Trise and Tfall.
4. This measurement refers to the total variation from the lowest crossing point to the highest, regardless of which edge is crossing.
5. Applies to a 2 pf load with both internal or external 50 Ω or 42.5 Ω Rp.
6. Measurement taken from Single Ended waveform.
7. Measurement taken from differential waveform.
8. Overshoot is defined as the absolute value of the maximum voltage.
9. Undershoot is defined as the absolute value of the minimum voltage.
10. ΔV_{cross} is defined as the total variation of all crossing voltages of Rising CLOCK and Falling CLOCK#. This is the maximum allowed variance in Vcross for any particular system.
11. Measured with oscilloscope, averaging off, using min max statistics. Variation is the delta between min and max.

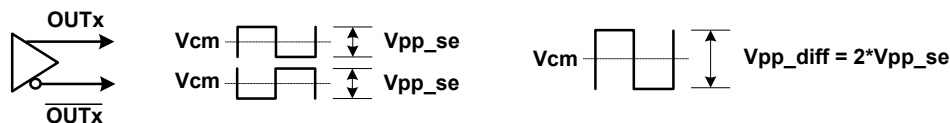

12. LVDS swing levels for 50 Ω transmission lines.
13. Max frequency is 333 + 1/3 MHz.

Table 5.7. LVCMOS Clock Output Specifications

($V_{DD} = V_{DDA} = V_{DD_DIG} = V_{DD_XTAL} = 1.8\text{ V to }3.3\text{ V } \pm 5\%/-5\%$, $V_{DDO} = 1.5\text{ V } \pm 5\%$, $1.8\text{ V } \pm 5\%$, $2.5\text{ V } \pm 5\%$, or $3.3\text{ V } \pm 5\%$, $T_A = -40$ to $105\text{ }^\circ\text{C}$)

Parameter	Symbol	Test Condition	Min	Typ	Max	Units
Frequency	f _{out}	1.8-3.3 V CMOS	5	—	170	MHz
		1.5 V CMOS	5	—	133.33	MHz
Rise/Fall Time, 3.3 V (20-80%)	t _R /t _F	50 Ω impedance, 5" trace, CL = 4 pf	—	0.5	0.8	ns
Rise/Fall Time, 2.5 V (20-80%)	t _R /t _F	50 Ω impedance, 5" trace CL = 4 pf	—	0.6	0.95	ns
Rise/Fall Time, 1.8 V (20-80%)	t _R /t _F	50 Ω impedance, 5" trace CL = 4 pf	—	0.75	1.3	ns
Rise/Fall Time, 1.5 V (20-80%)	t _R /t _F	50 Ω impedance, 5" trace CL = 4 pf	—	0.9	1.3	ns
CMOS Output Resistance (Single Strength. Corresponds to CBPro LVCMOS 50 Ω mode.)		3.3 V	—	46	—	Ω
		2.5 V	—	48	—	Ω
		1.8 V	—	53	—	Ω
		1.5 V	—	58	—	Ω
CMOS Output Resistance (Double Strength. Corresponds to CBPro LVCMOS 25 Ω mode.)		3.3 V	—	23	—	Ω
		2.5 V	—	24	—	Ω
		1.8 V	—	27	—	Ω
		1.5 V	—	29	—	Ω
CMOS Output Voltage	V _{OH}	−4 mA load	V _{DDO} -0.3	—	—	V
	V _{OL}	4 mA load	—	—	0.3	V
Duty Cycle	DC	XO and PLL mode	45	—	55	%

Table 5.8. Performance Characteristics(V_{DD} = V_{DDA} = V_{DD_DIG} = V_{DD_XTAL} = 1.8 V to 3.3 V +5%/-5%, V_{DDO} = 1.8 V ±5%, 2.5 V ±5%, or 3.3 V ±5%, T_A = -40 to 105 °C)

Parameter	Symbol	Test Condition	Min	Typ	Max	Units
Power Ramp	t _{VDD}	0 V to V _{DDmin}	0.1	—	10	ms
Initialization Time ¹	t _{initialization}	Time for I ² C to become operational after core supply exceeds V _{DDmin}	—	—	15	ms
Clock Stabilization from Power-up	t _{STABLE}	Time for clock outputs to appear after POR	—	15	25	ms
Input to Output Propagation Delay	t _{PROP}	Buffer mode (PLL Bypass)	—	3.75	4.25	ns
Spread Spectrum PP Frequency Deviation ²	SSDEV	MultiSynth Output < 250 MHz	0.1	—	2.5	%
0.5% Spread Frequency Deviation ²	SSDEV	MultiSynth Output < 250 MHz	0.4	0.45	0.5	%
Spread Spectrum Modulation Rate ³		MultiSynth Output < 250 MHz	30	31.5	33	kHz

Notes:

1. Outputs at same frequencies and using the same driver format.
2. The maximum step size is only limited by the register lengths; however, the MultiSynth output frequency must be kept between 5 MHz and 250 MHz.
3. Default value is ~31.5 kHz.

Table 5.9. Jitter Performance Specifications
 $(V_{DD} = V_{DDA} = V_{DD_DIG} = V_{DD_XTAL} = 1.8\text{ V to }3.3\text{ V }+5\%/-5\%, V_{DDO} = 1.8\text{ V } \pm 5\%, 2.5\text{ V } \pm 5\%, \text{ or } 3.3\text{ V } \pm 5\%, T_A = -40\text{ to }105\text{ }^\circ\text{C})$

Parameter	Symbol	Test Condition	Typ	Max	Units
Jitter Generation, Locked to External 25 MHz Clock ⁵	J _{GEN}	INT Mode 12 kHz – 20 MHz ^{1,2}	210	280	fs RMS
		FRAC Mode 12 kHz – 20 MHz ^{3,5}	250		fs RMS
	J _{PER}	Derived from integrated phase noise at a BER of 1e-12	4.5		ps Pk-Pk
	J _{CC}		3.8		ps Pk
	J _{PER}	N = 10, 000 cycles Integer or Fractional Mode. ^{2,3} Measured in the time domain. Performance is limited by the noise floor of the equipment.	12		ps Pk-Pk
	J _{CC}		11		ps Pk
Jitter Generation, Locked to External 25 MHz Crystal ⁵	J _{GEN}	INT Mode 12 kHz – 20 MHz ^{1,2}	190	240	fs RMS
		FRAC Mode 12 kHz – 20 MHz ^{3,5}	250		fs RMS
	J _{PER}	Derived from integrated phase noise at a BER of 1e-12	3.5		ps Pk-Pk
	J _{CC}		3.1		ps Pk
	J _{PER}	N = 10, 000 cycles Integer or Fractional Mode. ^{2,3} Measured in the time domain. Performance is limited by the noise floor of the equipment.	12		ps Pk-Pk
	J _{CC}		11		ps Pk
Power Supply Noise Rejection ⁶	PSNR	25 kHz	-67 (@25 kHz)	—	dBc
		50 kHz	-66 (@50 kHz)	—	
		100 kHz	-66 (@100 kHz)	—	
		500 kHz	-68 (@500 kHz)	—	
		1 MHz	-70 (@1 MHz)	—	

Notes:

1. INT jitter generation test conditions $f_{OUT} = 156.25\text{ MHz LVPECL}$.
2. Integer mode assumes that the output dividers (Nn/Nd) are configured with an integer value.
3. Fractional mode assumes that the output dividers (Nn/Nd) are configured with a fractional value and the feedback divider is an integer.
4. All jitter data in this table is based upon all output formats being differential. When LVCMOS outputs are used, there is the potential that the output jitter may increase due to the nature of LVCMOS outputs. If your configuration implements any LVCMOS output and any output is required to have jitter less than 3 ps RMS, contact Skyworks for support to validate your configuration and ensure the best jitter performance.
5. FRAC jitter generation test conditions $f_{OUT} = 150\text{ MHz LVPECL}$.
6. Measured at 156.25 MHz carrier frequency. Carrier power of -1.5 dBm. 100 mVpp sine wave noise added and noise spur amplitude measured. See "[AN491: Power Supply Rejection for Low-Jitter Clocks](#)" for further details on measurement methodology.

Table 5.10. PCI-Express Clock Outputs (100 MHz HCSL)(V_{DD} = V_{DDA} = V_{DD_DIG} = V_{DD_XTAL} = 1.8 V to 3.3 V +5%/-5%, V_{DDO} = 1.8 V ±5%, 2.5 V ±5%, or 3.3 V ±5%, T_A = -40 to 105 °C)

Parameter	Test Condition	SSC On/Off	Typ	Max	Units
PCIe Gen 1.1 ¹	Includes PLL BW 1.5–22 MHz, Peaking = 3 dB, Td = 10 ns, Ftrk = 1.5 MHz with BER = 1E-12 ²	Off	11	19	ps RMS
		On	22	30	ps RMS
PCIe Gen 2.1 ¹	Includes PLL BW 5MHz and 8–16 MHz, Jitter Peaking = 0.01–1 dB and 3 dB, Td = 12 ns, Low Band, F < 1.5 MHz	Off	0.02	0.026	ps RMS
		On	0.12	0.21	ps RMS
	Includes PLL BW 5 MHz and 8–16 MHz, Jitter Peaking = 0.01–1 dB and 3 dB, Td = 12 ns, High Band, 1.5 MHz < F < Nyquist ²	Off	0.2	0.31	ps RMS
		On	0.8	1.35	ps RMS
PCIe Gen 3.0 Common Clock ¹	Includes PLL BW 2–4 MHz and 5 MHz, Peaking = 0.01–2 dB and 1 dB, Td = 12 ns, CDR = 10 MHz ^{2, 3}	Off	0.06	0.1	ps RMS
		On	0.26	0.38	ps RMS
PCIe Gen 3.0 SRIS ¹	Includes PLL BW 4 MHz Peaking = 2 dB and 1dB, Td = 12 ns CDR = 10 MHz ^{2, 3}	On	0.35	0.37	ps RMS
PCIe Gen 4.0 Common Clock ¹	Includes PLL BW 2–4 MHz and 5 MHz, Peaking = 0.01–2 dB and 1 dB, Td = 12 ns, CDR = 10 MHz ^{2, 3}	Off	0.05	0.1	ps RMS
		On	0.26	0.38	ps RMS
PCIe Gen 4.0 SRIS ¹	Includes PLL BW 4 MHz Peaking = 2 dB and 1dB, Td = 12 ns CDR = 10 MHz ^{2, 3}	On	0.31	0.38	ps RMS
PCIe Gen 5.0 Common Clock ¹		Off	0.025	0.04	ps RMS
		On	0.1	0.15	ps RMS
PCIe Gen 5.0 SRIS ¹		On	0.08	0.1	ps RMS

Note:

- All jitter data in this table is based upon all output formats being differential. When LVCMOS outputs are used, there is the potential that the output jitter may increase due to the nature of LVCMOS outputs. If your configuration implements any LVCMOS output and any output is required to have jitter less than 3 ps RMS, contact Skyworks for support to validate your configuration and ensure the best jitter performance.
- All output clocks 100 MHz HCSL format. Jitter data taken from Clock Jitter Tool v.1.3.
- Excludes oscilloscope sampling noise.

Table 5.11. Fanout Mode Additive Jitter Performance Specifications(V_{DD} = V_{DDA} = V_{DD_DIG} = V_{DD_XTAL} = 1.8 V to 3.3 V +5%/-5%, V_{DDO} = 1.8 V ±5%, 2.5 V ±5%, or 3.3 V ±5%, T_A = -40 to 105 °C)

Parameter	Symbol	Test Condition	Typ	Max	Units
Additive Phase Jitter ¹		156.25 MHz, 12 kHz–20 MHz ¹ , LVDS (slow mode)	130 (LVDS slow)	170	fs RMS
		156.25 MHz, 12 kHz–20 MHz, LVDS (fast mode)	120	150	fs RMS
		156.25 MHz, 12 kHz–20 MHz, LVPECL ¹	110	140	fs RMS
		156.25 MHz, 12 kHz–20 MHz, HCSL ¹	120	150	fs RMS
PCIe Gen 3/4 Additive Phase Jitter ²	JADD_GEN3 JADD_GEN4	Includes PLL BW 2–4 MHz, CDR = 10 MHz	54	69	fs RMS
PCIe Gen 5 Additive Phase Jitter ²	JADD_GEN5	Includes PLL BW 500 kHz–1.8 MHz, CDR = 20 MHz	21	27	fs RMS

Note:

1. Measured with 100 MHz differential input on CLKIN_2, bypassing the PLL to any output.
2. Skyworks PCIe Clock Jitter Tool is used to obtain measurements for additive phase jitter. Additive Phase Jitter = $\sqrt{\text{output jitter}^2 - \text{input jitter}^2}$. Input used is 100 MHz from Si5340.
3. Measurements on 100 MHz output use the template file in the PCIe Clock Jitter Tool.
4. For complete PCIe specifications, visit www.pcisig.com.
5. Input clock slew rate of 3.0 V/ns used for jitter measurements.

Table 5.12. Thermal Characteristics

Parameter	Symbol	Test Condition ¹	Value	Units
Si53350 — 48 QFN				
Thermal Resistance, Junction to Ambient	θ_{JA}	Still Air	12 ²	°C/W
		Air Flow 1 m/s	9.7 ²	
		Air Flow 2 m/s	8.7 ²	
Thermal Resistance, Junction to Case	θ_{JC}		2.2 ²	
Thermal Resistance, Junction to Board	θ_{JB}		3.6 ²	
	ψ_{JB}		3.2 ²	
Thermal Resistance, Junction to Top Center	ψ_{JT}		0.4 ²	
Si5332 — 40 QFN				
Thermal Resistance, Junction to Ambient	θ_{JA}	Still Air	23.1 ¹	°C/W
		Air Flow 1 m/s	17.5 ¹	
		Air Flow 2 m/s	16.5 ¹	
Thermal Resistance, Junction to Case	θ_{JC}	Still Air	13.4 ¹	
Thermal Resistance, Junction to Board	θ_{JB}	Still Air	8.7 ¹	
	ψ_{JB}	Still Air	8.4 ¹	
Thermal Resistance, Junction to Top Center	ψ_{JT}	Still Air	0.3 ¹	
Si5332 — 32 QFN				
Thermal Resistance, Junction to Ambient	θ_{JA}	Still Air	28.4 ¹	°C/W
		Air Flow 1 m/s	24 ¹	
		Air Flow 2 m/s	23 ¹	
Thermal Resistance, Junction to Case	θ_{JC}	Still Air	15.9 ¹	
Thermal Resistance, Junction to Board	θ_{JB}	Still Air	11.5 ¹	
	ψ_{JB}	Still Air	11.2 ¹	
Thermal Resistance, Junction to Top Center	ψ_{JT}	Still Air	0.4 ¹	
Note:				
1. Based on a JEDEC standard 4-layer PCB.				
2. Based on Si5332-12A-EVB (PCB dimensions: 9" x 9"; PCB thickness: 0.062"; number of PCB layers: 8)				

Table 5.13. Absolute Maximum Ratings^{1,2,3}

Parameter	Symbol	Test Condition	Value	Units
Storage Temperature Range	T _{STG}		-55 to +150	°C
DC Supply Voltage	V _{DD}		-0.5 to 3.8	V
	V _{DDA}		-0.5 to 3.8	V
	V _{DDxtal}		-0.5 to 3.8	V
	V _{DDO}		-0.5 to 3.8	V
Input Voltage Range	V _I	XIN/XOUT	-0.3 to 1.3	V
Latch-up Tolerance	LU		JESD78 Compliant	
ESD Tolerance	HBM	32-pin, 40-pin, 48-pin packages: 100 pF, 1.5 kΩ	2.0	kV
	CDM	32-pin, 40-pin packages	500	V
		48-pin package: All pins except for XA/ CLKIN1 and XB	500	V
		48-pin package: XA/CLKIN1 and XB pins	450	V
Junction Temperature	T _{JCT}		-55 to 125	°C
Soldering Temperature	T _{PEAK}		260	°C
Soldering Temperature Time at T _{PEAK}	T _P		20 to 40	sec

Notes:

1. Permanent device damage may occur if the absolute maximum ratings are exceeded. Functional operation should be restricted to the conditions as specified in the operational sections of this data sheet. Exposure to absolute maximum rating conditions for extended periods may affect device reliability.
2. For more packaging information, go to https://www.skyworksinc.com/product_certificate.aspx.
3. The device is compliant with JEDEC J-STD-020.

6. Pin Descriptions

6.1 Pin Descriptions (48-QFN)



Figure 6.1. 48-QFN

Table 6.1. Si5332 Pin Descriptions (48-QFN)

Pin Number	Pin Name	Pin Type	Function
1	VDD_DIG	P	Voltage supply for digital functions. Connect to 1.8–3.3 V. Part of internal core VDD voltage. Must be connected to same voltage as VDDA and VDD_XTAL.
2	CLKIN_2	I	These pins accept both differential and single-ended clock signals. Refer to Section 3.4.2 Input Clocks for input termination options. These pins are high-impedance and must be terminated externally. If both the CLKIN_2 and CLKIN_2b inputs are un-used and powered down, then both inputs can be left floating. ClockBuilder Pro will power down an input that is set as "Unused".
3	CLKIN_2b	I	
4	VDD_XTAL	P	Voltage supply for crystal oscillator. Connect to 1.8–3.3 V. Part of internal core VDD voltage. Must be connected to same voltage as VDDA and VDD_XTAL.
5	XA/CLKIN1	I	These pins are used for an optional XTAL input when operating the device in asynchronous mode (i.e. free-run mode). Refer to Section 5. Electrical Specifications for recommended crystal specifications.
6	XB	O	
7	CLKIN_3	I	These pins accept both differential and single-ended clock signals. Refer to Section 3.4.2 Input Clocks for input termination options. These pins are high-impedance and must be terminated externally. If both the CLKIN_3 and CLKIN_3b inputs are unused and powered down, then both inputs can be left floating. ClockBuilder Pro will power down an input that is set as "Unused".
8	CLKIN_3b	I	
9	VDDA	P	Core Supply Voltage. Connect to 1.8–3.3 V. See the <i>Si5332 Family Reference Manual</i> for power supply filtering recommendations. Must be connected to same voltage as VDD_DIG and VDD_XTAL.
10	UNIVERSAL1	I/O	Universal HW Input pin. This hardware input pin is user definable through ClockBuilder Pro. Refer to Section 3.7 Universal Hardware Pins for a list of definitions that hardware input pins can be used for.
11	UNIVERSAL2	I/O	Universal HW Input pin. This hardware input pin is user definable through ClockBuilder Pro. Refer to Section 3.7 Universal Hardware Pins for a list of definitions that hardware input pins can be used for.
12	UNIVERSAL3	I/O	Universal HW Input pin. This hardware input pin is user definable through ClockBuilder Pro. Refer to Section 3.7 Universal Hardware Pins for a list of definitions that hardware input pins can be used for.
13	SCLK	I	Serial Clock Input This pin functions as the serial clock input for I ² C. SCLK is a digital input internally referenced to VDD_DIG. SCLK must have an external pull-up resistor (I ² C bus pull-up) to same voltage as VDD_DIG.
14	SDA	I/O	Serial Data Interface This is the bidirectional data pin (SDA) for the I ² C mode. SDA is a digital open-drain bi-directional internally referenced to VDD_DIG. SDA must have an external pull-up resistor (I ² C bus pull-up) to same voltage as VDD_DIG.

Pin Number	Pin Name	Pin Type	Function
15	OUT0b	O	Output Clock
16	OUT0	O	These output clocks support a programmable signal swing and common mode voltage. Desired output signal format is configurable using register control. Termination recommendations are provided in 3.5.2 Differential Output Terminations and 3.5.3 LVCMOS Output Terminations . Unused outputs should be left unconnected.
17	VDDO0	P	Supply Voltage (1.8–3.3 V, or 1.5 V for CMOS only) for OUT0 See the <i>Si5332 Family Reference Manual</i> for power supply filtering recommendations. Leave VDDOx pins of unused output drivers unconnected. An alternate option is to connect the VDDOx pin to a power supply and disable the output driver to minimize current consumption.
18	OUT1b	O	Output Clock
19	OUT1	O	These output clocks support a programmable signal swing and common mode voltage. Desired output signal format is configurable using register control. Termination recommendations are provided in 3.5.2 Differential Output Terminations and 3.5.3 LVCMOS Output Terminations . Unused outputs should be left unconnected.
20	VDDO1	P	Supply Voltage (1.8–3.3 V, or 1.5 V for CMOS only) for OUT1 and OUT2 See the <i>Si5332 Family Reference Manual</i> for power supply filtering recommendations. Leave VDDOx pins of unused output drivers unconnected. An alternate option is to connect the VDDOx pin to a power supply and disable the output driver to minimize current consumption.
21	OUT2b	O	Output Clock
22	OUT2	O	These output clocks support a programmable signal swing and common mode voltage. Desired output signal format is configurable using register control. Termination recommendations are provided in 3.5.2 Differential Output Terminations and 3.5.3 LVCMOS Output Terminations . Unused outputs should be left unconnected.
23	UNIVERSAL4	I/O	Universal HW Input pin. This hardware input pin is user definable through ClockBuilder Pro. Refer to Section 3.7 Universal Hardware Pins for a list of definitions that hardware input pins can be used for.
24	VDDO2	P	Supply Voltage (1.8–3.3 V, or 1.5 V for CMOS only) for OUT3, OUT4, and OUT5 See the <i>Si5332 Family Reference Manual</i> for power supply filtering recommendations. Leave VDDOx pins of unused output drivers unconnected. An alternate option is to connect the VDDOx pin to a power supply and disable the output driver to minimize current consumption.
25	OUT3b	O	Output Clock
26	OUT3	O	These output clocks support a programmable signal swing & common mode voltage. Desired output signal format is configurable using register control. Termination recommendations are provided in 3.5.2 Differential Output Terminations and 3.5.3 LVCMOS Output Terminations . Unused outputs should be left unconnected.

Pin Number	Pin Name	Pin Type	Function
27	OUT4b	O	Output Clock
28	OUT4	O	These output clocks support a programmable signal swing & common mode voltage. Desired output signal format is configurable using register control. Termination recommendations are provided in 3.5.2 Differential Output Terminations and 3.5.3 LVCMOS Output Terminations . Unused outputs should be left unconnected.
29	OUT5b	O	Output Clock
30	OUT5	O	These output clocks support a programmable signal swing & common mode voltage. Desired output signal format is configurable using register control. Termination recommendations are provided in 3.5.2 Differential Output Terminations and 3.5.3 LVCMOS Output Terminations . Unused outputs should be left unconnected.
31	OUT6b	O	Output Clock
32	OUT6	O	These output clocks support a programmable signal swing & common mode voltage. Desired output signal format is configurable using register control. Termination recommendations are provided in 3.5.2 Differential Output Terminations and 3.5.3 LVCMOS Output Terminations . Unused outputs should be left unconnected.
33	OUT7b	O	Output Clock
34	OUT7	O	These output clocks support a programmable signal swing & common mode voltage. Desired output signal format is configurable using register control. Termination recommendations are provided in 3.5.2 Differential Output Terminations and 3.5.3 LVCMOS Output Terminations . Unused outputs should be left unconnected.
35	OUT8b	O	Output Clock
36	OUT8	O	These output clocks support a programmable signal swing & common mode voltage. Desired output signal format is configurable using register control. Termination recommendations are provided in 3.5.2 Differential Output Terminations and 3.5.3 LVCMOS Output Terminations . Unused outputs should be left unconnected.
37	VDDO3	P	Supply Voltage (1.8–3.3 V, or 1.5 V for CMOS only) for OUT6, OUT7, and OUT8 See the <i>Si5332 Family Reference Manual</i> for power supply filtering recommendations. Leave VDDOx pins of unused output drivers unconnected. An alternate option is to connect the VDDOx pin to a power supply and disable the output driver to minimize current consumption.
38	UNIVERSAL5	I/O	Universal HW Input pin. This hardware input pin is user definable through ClockBuilder Pro. Refer to 3.7 Universal Hardware Pins for a list of definitions that hardware input pins can be used for.
39	VDDO4	P	Supply Voltage (1.8–3.3 V, or 1.5 V for CMOS only) for OUT9 See the <i>Si5332 Family Reference Manual</i> for power supply filtering recommendations. Leave VDDOx pins of unused output drivers unconnected. An alternate option is to connect the VDDOx pin to a power supply and disable the output driver to minimize current consumption.

Pin Number	Pin Name	Pin Type	Function
40	OUT9b	O	Output Clock
41	OUT9	O	These output clocks support a programmable signal swing & common mode voltage. Desired output signal format is configurable using register control. Termination recommendations are provided in 3.5.2 Differential Output Terminations and 3.5.3 LVCMOS Output Terminations . Unused outputs should be left unconnected.
42	UNIVERSAL6	I/O	Universal HW Input pin. This hardware input pin is user definable through ClockBuilder Pro. Refer to 3.7 Universal Hardware Pins for a list of definitions that hardware input pins can be used for.
43	UNIVERSAL7	I/O	Universal HW Input pin. This hardware input pin is user definable through ClockBuilder Pro. Refer to 3.7 Universal Hardware Pins for a list of definitions that hardware input pins can be used for.
44	VDDO5	P	Supply Voltage (1.8–3.3 V, or 1.5 V for CMOS only) for OUT10 and OUT11 See the <i>Si5332 Family Reference Manual</i> for power supply filtering recommendations. Leave VDDOx pins of unused output drivers unconnected. An alternate option is to connect the VDDOx pin to a power supply and disable the output driver to minimize current consumption.
45	OUT10b	O	Output Clock
46	OUT10	O	These output clocks support a programmable signal swing & common mode voltage. Desired output signal format is configurable using register control. Termination recommendations are provided in 3.5.2 Differential Output Terminations and 3.5.3 LVCMOS Output Terminations . Unused outputs should be left unconnected.
47	OUT11b	O	Output Clock
48	OUT11	O	These output clocks support a programmable signal swing & common mode voltage. Desired output signal format is configurable using register control. Termination recommendations are provided in 3.5.2 Differential Output Terminations and 3.5.3 LVCMOS Output Terminations . Unused outputs should be left unconnected.
49	GND PAD	P	Ground Pad This pad provides electrical and thermal connection to ground and must be connected for proper operation.

6.2 Pin Descriptions (40-QFN)

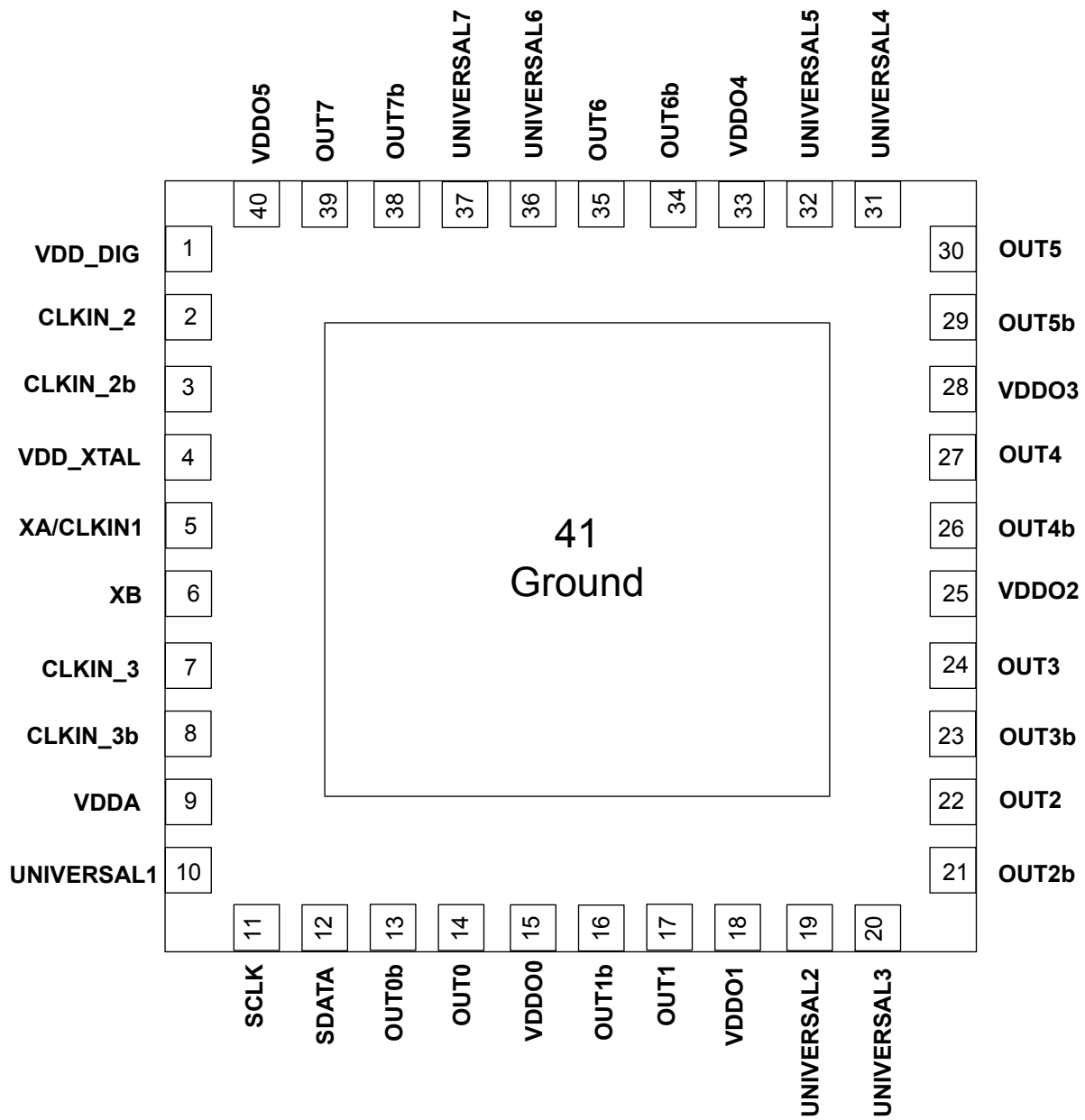

Figure 6.2. 40-QFN

Table 6.2. Si5332 Pin Descriptions (40-QFN)

Pin Number	Pin Name	Pin Type	Function
1	VDD_DIG	P	Voltage supply for digital functions. Connect to 1.8–3.3 V. Part of internal core VDD voltage. Must be connected to same voltage as VDDA and VDD_XTAL.
2	CLKIN_2	I	These pins accept both differential and single-ended clock signals. Refer to Section 3.4.2 Input Clocks for input termination options. These pins are high-impedance and must be terminated externally. If both the CLKIN_2 and CLKIN_2b inputs are un-used and powered down, then both inputs can be left floating. ClockBuilder Pro will power down an input that is set as "Unused".
3	CLKIN_2b	I	
4	VDD_XTAL	P	Voltage supply for crystal oscillator. Connect to 1.8–3.3 V. Part of internal core VDD voltage. Must be connected to same voltage as VDDA and VDD_DIG.
5	XA/CLKIN1	I	Si5332A/B/C/D: These pins are used for an optional XTAL input when operating the device in asynchronous mode (i.e. free-run mode). Refer to Section 5. Electrical Specifications for recommended crystal specifications.
6	XB	O	
7	CLKIN_3	I	These pins accept both differential and single-ended clock signals. Refer to Section 3.4.2 Input Clocks for input termination options. These pins are high-impedance and must be terminated externally. If both the CLKIN_3 and CLKIN_3b inputs are un-used and powered down, then both inputs can be left floating. ClockBuilder Pro will power down an input that is set as "Unused".
8	CLKIN_3b	I	
9	VDDA	P	Core Supply Voltage. Connect to 1.8–3.3 V. See the Si5332-AM1/2/3 Family Reference Manual for power supply filtering recommendations. Must be connected to same voltage as VDD_DIG and VDD_XTAL.
10	UNIVERSAL1	I/O	Universal HW pin. This hardware pin is user-definable through ClockBuilder Pro. Refer to Section 3.7 Universal Hardware Pins for a list of definitions that hardware input pins can be used for.
11	SCLK	I	Serial Clock Input This pin functions as the serial clock input for I ² C. SCLK is a digital input internally referenced to VDD_DIG. SCLK must have an external pull-up resistor (I ² C bus pull-up) to same voltage as VDD_DIG.
12	SDATA	I/O	Serial Data Interface This is the bidirectional data pin for the I ² C mode. SDA is a digital, open-drain, bi-directional pin internally referenced to VDD_DIG. SDA must have an external pull-up resistor (I ² C bus pull-up) to same voltage as VDD_DIG.
13	OUT0b	O	Output Clock These output clocks support a programmable signal swing and common mode voltage. Desired output signal format is configurable using register control. Termination recommendations are provided in 3.5.2 Differential Output Terminations and 3.5.3 LVCMOS Output Terminations . Unused outputs should be left unconnected.
14	OUT0	O	

Pin Number	Pin Name	Pin Type	Function
15	VDDO0	P	<p>Supply Voltage (1.8–3.3 V, or 1.5 V for CMOS only) for OUT0</p> <p>See the Si5332-AM1/2/3 Family Reference Manual for power supply filtering recommendations.</p> <p>Leave VDDOx pins of unused output drivers unconnected. An alternate option is to connect the VDDOx pin to a power supply and disable the output driver to minimize current consumption.</p>
16	OUT1b	O	<p>Output Clock</p> <p>These output clocks support a programmable signal swing and common mode voltage. Desired output signal format is configurable using register control. Termination recommendations are provided in 3.5.2 Differential Output Terminations and 3.5.3 LVCMOS Output Terminations. Unused outputs should be left unconnected.</p>
17	OUT1	O	
18	VDDO1	P	<p>Supply Voltage (1.8–3.3 V, or 1.5 V for CMOS only) for OUT1</p> <p>See the Si5332-AM1/2/3 Family Reference Manual for power supply filtering recommendations.</p> <p>Leave VDDOx pins of unused output drivers unconnected. An alternate option is to connect the VDDOx pin to a power supply and disable the output driver to minimize current consumption.</p>
19	UNIVERSAL2	I/O	Universal HW pin. This hardware pin is user-definable through ClockBuilder Pro. Refer to 3.7 Universal Hardware Pins for a list of definitions that hardware input pins can be used for.
20	UNIVERSAL3	I/O	Universal HW pin. This hardware pin is user-definable through ClockBuilder Pro. Refer to 3.7 Universal Hardware Pins for a list of definitions that hardware input pins can be used for.
21	OUT2b	O	<p>Output Clock</p> <p>These output clocks support a programmable signal swing and common mode voltage. Desired output signal format is configurable using register control. Termination recommendations are provided in 3.5.2 Differential Output Terminations and 3.5.3 LVCMOS Output Terminations. Unused outputs should be left unconnected.</p>
22	OUT2	O	
23	OUT3b	O	<p>Output Clock</p> <p>These output clocks support a programmable signal swing and common mode voltage. Desired output signal format is configurable using register control. Termination recommendations are provided in 3.5.2 Differential Output Terminations and 3.5.3 LVCMOS Output Terminations. Unused outputs should be left unconnected.</p>
24	OUT3	O	
25	VDDO2	P	<p>Supply Voltage (1.8–3.3 V, or 1.5 V for CMOS only) for OUT2 and OUT3</p> <p>See the Si5332-AM1/2/3 Family Reference Manual for power supply filtering recommendations.</p> <p>Leave VDDOx pins of unused output drivers unconnected. An alternate option is to connect the VDDOx pin to a power supply and disable the output driver to minimize current consumption.</p>
26	OUT4b	O	<p>Output Clock</p> <p>These output clocks support a programmable signal swing and common mode voltage. Desired output signal format is configurable using register control. Termination recommendations are provided in 3.5.2 Differential Output Terminations and 3.5.3 LVCMOS Output Terminations. Unused outputs should be left unconnected.</p>
27	OUT4	O	

Pin Number	Pin Name	Pin Type	Function
28	VDDO3	P	<p>Supply Voltage (1.8–3.3 V, or 1.5 V for CMOS only) for OUT4 and OUT5</p> <p>See the Si5332-AM1/2/3 Family Reference Manual for power supply filtering recommendations.</p> <p>Leave VDDOx pins of unused output drivers unconnected. An alternate option is to connect the VDDOx pin to a power supply and disable the output driver to minimize current consumption.</p>
29	OUT5b	O	<p>Output Clock</p> <p>These output clocks support a programmable signal swing and common mode voltage. Desired output signal format is configurable using register control. Termination recommendations are provided in 3.5.2 Differential Output Terminations and 3.5.3 LVCMOS Output Terminations. Unused outputs should be left unconnected.</p>
30	OUT5	O	
31	UNIVERSAL4	I/O	Universal HW pin. This hardware pin is user-definable through ClockBuilder Pro. Refer to 3.7 Universal Hardware Pins for a list of definitions that hardware input pins can be used for.
32	UNIVERSAL5	I/O	Universal HW pin. This hardware pin is user-definable through ClockBuilder Pro. Refer to 3.7 Universal Hardware Pins for a list of definitions that hardware input pins can be used for.
33	VDDO4	P	<p>Supply Voltage (1.8–3.3 V, or 1.5 V for CMOS only) for OUT6</p> <p>See the Si5332-AM1/2/3 Family Reference Manual for power supply filtering recommendations.</p> <p>Leave VDDOx pins of unused output drivers unconnected. An alternate option is to connect the VDDOx pin to a power supply and disable the output driver to minimize current consumption.</p>
34	OUT6b	O	<p>Output Clock</p> <p>These output clocks support a programmable signal swing and common mode voltage. Desired output signal format is configurable using register control. Termination recommendations are provided in 3.5.2 Differential Output Terminations and 3.5.3 LVCMOS Output Terminations. Unused outputs should be left unconnected.</p>
35	OUT6	O	
36	UNIVERSAL6	I/O	Universal HW pin. This hardware pin is user-definable through ClockBuilder Pro. Refer to 3.7 Universal Hardware Pins for a list of definitions that hardware input pins can be used for.
37	UNIVERSAL7	I/O	Universal HW pin. This hardware pin is user-definable through ClockBuilder Pro. Refer to 3.7 Universal Hardware Pins for a list of definitions that hardware input pins can be used for.
38	OUT7b	O	<p>Output Clock</p> <p>These output clocks support a programmable signal swing and common mode voltage. Desired output signal format is configurable using register control. Termination recommendations are provided in 3.5.2 Differential Output Terminations and 3.5.3 LVCMOS Output Terminations. Unused outputs should be left unconnected.</p>
39	OUT7	O	
40	VDDO5	P	<p>Supply Voltage (1.8–3.3 V, or 1.5 V for CMOS only) for OUT7</p> <p>See the Si5332-AM1/2/3 Family Reference Manual for power supply filtering recommendations.</p> <p>Leave VDDOx pins of unused output drivers unconnected. An alternate option is to connect the VDDOx pin to a power supply and disable the output driver to minimize current consumption.</p>

Pin Number	Pin Name	Pin Type	Function
41	GND PAD	P	<p>Ground Pad</p> <p>This pad provides electrical and thermal connection to ground and must be connected for proper operation.</p>

6.3 Pin Descriptions (32-QFN)



Figure 6.3. 32-QFN

Table 6.3. Si5332 Pin Descriptions, (32-QFN)

Pin Number	Pin Name	Pin Type	Function
1	VDD_DIG	P	Voltage supply for digital functions. Connect to 1.8–3.3 V. Part of internal core VDD voltage. Must be connected to same voltage as VDDA and VDD_XTAL.
2	CLKIN_2	I	These pins accept both differential and single-ended clock signals. Refer to Section 3.4.2 Input Clocks for input termination options. These pins are high-impedance and must be terminated externally. If both the CLKIN_2 and CLKIN_2b inputs are un-used and powered down, then both inputs can be left floating. ClockBuilder Pro will power down an input that is set as "Unused".
3	CLKIN_2b	I	
4	VDD_XTAL	P	Voltage supply for crystal oscillator. Connect to 1.8–3.3 V. Part of internal core VDD voltage. Must be connected to same voltage as VDDA and VDD_DIG.
5	XA/CLKIN1	I	Si5332A/B/C/D
6	XB	O	These pins are used for an optional XTAL input when operating the device in asynchronous mode (i.e. free-run mode). Refer to Section 5. Electrical Specifications for recommended crystal specifications.

Pin Number	Pin Name	Pin Type	Function
7	VDDA	P	<p>Core Supply Voltage. Connect to 1.8–3.3 V.</p> <p>See the Si5332-AM1/2/3 Family Reference Manual for power supply filtering recommendations.</p> <p>Must be connected to same voltage as VDD_DIG and VDD_XTAL.</p>
8	UNIVERSAL1	I/O	<p>Universal HW pin. This hardware pin is user-definable through ClockBuilder Pro. Refer to Section 3.7 Universal Hardware Pins for a list of definitions that hardware input pins can be used for.</p>
9	SCLK	I	<p>Serial Clock Input</p> <p>This pin functions as the serial clock input for I²C.</p> <p>SCLK is a digital input internally referenced to VDD_DIG. SCLK must have an external pull-up resistor (I²C bus pull-up) to same voltage as VDD_DIG.</p>
10	SDATA	I/O	<p>Serial Data Interface</p> <p>This is the bidirectional data pin for the I²C mode.</p> <p>SDA is a digital, open-drain, bi-directional pin internally referenced to VDD_DIG. SDA must have an external pull-up resistor (I²C bus pull-up) to same voltage as VDD_DIG.</p>
11	OUT0b	O	<p>Output Clock</p>
12	OUT0	O	<p>These output clocks support a programmable signal swing and common mode voltage. Desired output signal format is configurable using register control. Termination recommendations are provided in 3.5.2 Differential Output Terminations and 3.5.3 LVCMOS Output Terminations. Unused outputs should be left unconnected.</p>
13	VDDO0	P	<p>Supply Voltage (1.8–3.3 V, or 1.5 V for CMOS only) for OUT0</p> <p>See the Si5332-AM1/2/3 Family Reference Manual for power supply filtering recommendations.</p> <p>Leave VDDOx pins of unused output drivers unconnected. An alternate option is to connect the VDDOx pin to a power supply and disable the output driver to minimize current consumption.</p>
14	OUT1b	O	<p>Output Clock</p>
15	OUT1	O	<p>These output clocks support a programmable signal swing & common mode voltage. Desired output signal format is configurable using register control. Termination recommendations are provided in 3.5.2 Differential Output Terminations and 3.5.3 LVCMOS Output Terminations. Unused outputs should be left unconnected.</p>
16	VDDO1	P	<p>Supply Voltage (1.8–3.3 V, or 1.5 V for CMOS only) for OUT1</p> <p>See the Si5332-AM1/2/3 Family Reference Manual for power supply filtering recommendations.</p> <p>Leave VDDOx pins of unused output drivers unconnected. An alternate option is to connect the VDDOx pin to a power supply and disable the output driver to minimize current consumption.</p>
17	UNIVERSAL2	I/O	<p>Universal HW pin. This hardware pin is user-definable through ClockBuilder Pro. Refer to Section 3.7 Universal Hardware Pins for a list of definitions that hardware input pins can be used for.</p>

Pin Number	Pin Name	Pin Type	Function
18	OUT2b	O	Output Clock
19	OUT2	O	These output clocks support a programmable signal swing and common mode voltage. Desired output signal format is configurable using register control. Termination recommendations are provided in 3.5.2 Differential Output Terminations and 3.5.3 LVCMOS Output Terminations . Unused outputs should be left unconnected.
20	VDDO2	P	Supply Voltage (1.8–3.3 V, or 1.5 V for CMOS only) for OUT2 See the Si5332-AM1/2/3 Family Reference Manual for power supply filtering recommendations. Leave VDDOx pins of unused output drivers unconnected. An alternate option is to connect the VDDOx pin to a power supply and disable the output driver to minimize current consumption.
21	OUT3b	O	Output Clock
22	OUT3	O	These output clocks support a programmable signal swing and common mode voltage. Desired output signal format is configurable using register control. Termination recommendations are provided in 3.5.2 Differential Output Terminations and 3.5.3 LVCMOS Output Terminations . Unused outputs should be left unconnected.
23	VDDO3	P	Supply Voltage (1.8–3.3 V, or 1.5 V for CMOS only) for OUT3 See the Si5332-AM1/2/3 Family Reference Manual for power supply filtering recommendations. Leave VDDOx pins of unused output drivers unconnected. An alternate option is to connect the VDDOx pin to a power supply and disable the output driver to minimize current consumption.
24	UNIVERSAL3	I/O	Universal HW pin. This hardware pin is user-definable through ClockBuilder Pro. Refer to Section 3.7 Universal Hardware Pins for a list of definitions that hardware input pins can be used for.
25	VDDO4	P	Supply Voltage (1.8–3.3 V, or 1.5 V for CMOS only) for OUT4 See the Si5332-AM1/2/3 Family Reference Manual for power supply filtering recommendations. Leave VDDOx pins of unused output drivers unconnected. An alternate option is to connect the VDDOx pin to a power supply and disable the output driver to minimize current consumption.
26	OUT4b	O	Output Clock
27	OUT4	O	These output clocks support a programmable signal swing and common mode voltage. Desired output signal format is configurable using register control. Termination recommendations are provided in 3.5.2 Differential Output Terminations and 3.5.3 LVCMOS Output Terminations . Unused outputs should be left unconnected.
28	UNIVERSAL4	I/O	Universal HW pin. This hardware pin is user-definable through ClockBuilder Pro. Refer to Section 3.7 Universal Hardware Pins for a list of definitions that hardware input pins can be used for.
29	UNIVERSAL5	I/O	Universal HW pin. This hardware pin is user-definable through ClockBuilder Pro. Refer to Section 3.7 Universal Hardware Pins for a list of definitions that hardware input pins can be used for.

Pin Number	Pin Name	Pin Type	Function
30	OUT5b	O	Output Clock
31	OUT5	O	These output clocks support a programmable signal swing and common mode voltage. Desired output signal format is configurable using register control. Termination recommendations are provided in 3.5.2 Differential Output Terminations and 3.5.3 LVCMOS Output Terminations . Unused outputs should be left unconnected.
32	VDDO5	P	Supply Voltage (1.8–3.3 V, or 1.5 V for CMOS only) for OUT5 See the Si5332-AM1/2/3 Family Reference Manual for power supply filtering recommendations. Leave VDDOx pins of unused output drivers unconnected. An alternate option is to connect the VDDOx pin to a power supply and disable the output driver to minimize current consumption.
33	GND PAD	P	Ground Pad This pad provides electrical and thermal connection to ground and must be connected for proper operation.

7. Package Outline

7.1 Si5332-AM3 7x7 mm 48-QFN Package Diagram

The figure below illustrates the package details for 48-QFN. The table below lists the values for the dimensions shown in the illustration.

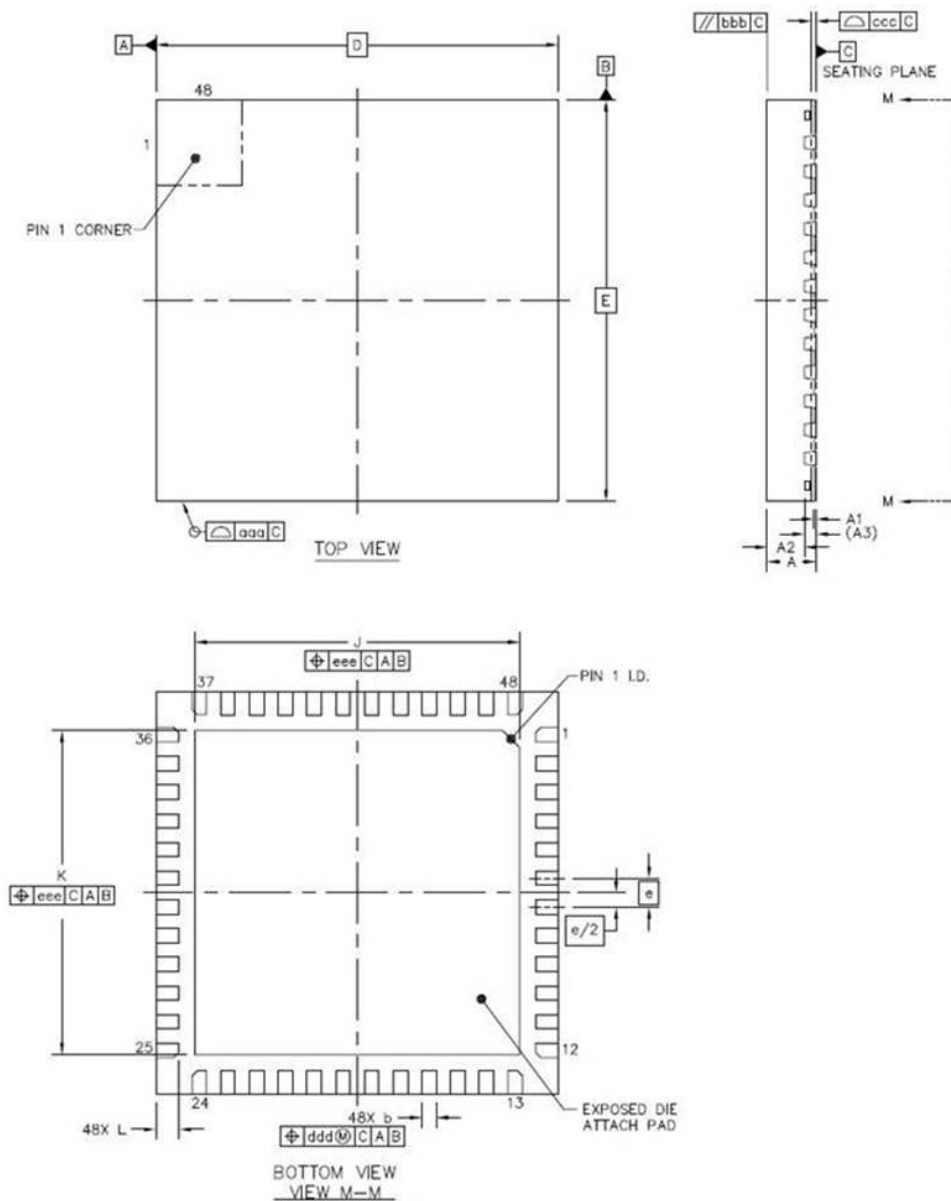

Figure 7.1. 48-Pin Quad Flat No-Lead (QFN)

Table 7.1. Package Dimensions

Dimension	Min	Nom	Max
A	0.80	0.85	0.90
A1	00	0.035	0.05
A2	--	0.65	0.67
A3	0.203 REF		
b	0.20	0.25	0.30
D	7 BSC		

Dimension	Min	Nom	Max
E	7 BSC		
e	0.5 BSC		
J	5.55	5.65	5.75
K	5.55	5.65	5.75
L	0.35	0.40	0.45
aaa	0.10		
bbb	0.10		
ccc	0.08		
ddd	0.10		
eee	0.10		

Notes:

1. All dimensions shown are in millimeters (mm) unless otherwise noted.
2. Dimensions and Tolerances per ANSI Y14.5M-1994.
3. This drawing conforms to the JEDEC Solid State Outline MO-220, Variation VLLD-5
4. Recommended card re-flow profile is per the JEDEC/IPC J-STD-020 specification for Small Body Components.

7.2 Si5332-AM2 6x6 mm 40-QFN Package Diagram

The figure below illustrates the package details for the Si5332-AM2 in 40-QFN. The table below lists the values for the dimensions shown in the illustration.

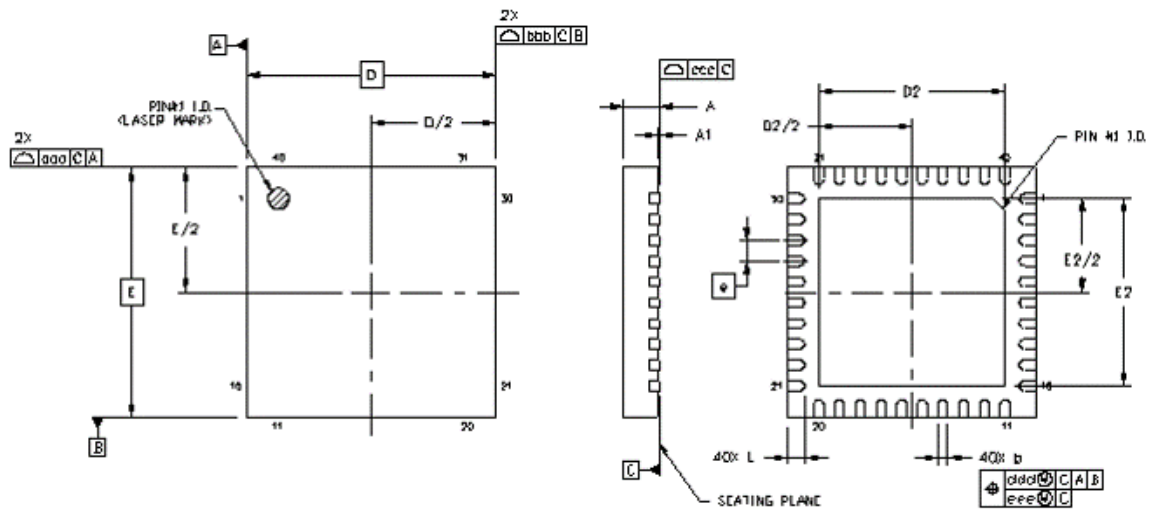

Figure 7.2. 40-Pin Quad Flat No-Lead (QFN)

Table 7.2. Package Dimensions

Dimension	Min	Nom	Max
A	0.80	0.85	0.90
A1	0.00	0.02	0.05
b	0.18	0.25	0.30
D	6.00 BSC		
D2	4.35	4.50	4.65
e	0.50 BSC		
E	6.00 BSC		
E2	4.35	4.50	4.65
L	0.30	0.40	0.50
aaa	—	—	0.15
bbb	—	—	0.15
ccc	—	—	0.08
ddd	—	—	0.10
eee	—	—	0.05

Notes:

1. All dimensions shown are in millimeters (mm) unless otherwise noted.
2. Dimensioning and Tolerancing per ANSI Y14.5M-1994.
3. This drawing conforms to the JEDEC Solid State Outline MO-220.
4. Recommended card reflow profile is per the JEDEC/IPC J-STD-020 specification for Small Body Components.

7.3 Si5332-AM1 5x5 mm 32-QFN Package Diagram

The figure below illustrates the package details for the Si5332-AM1 32-QFN option. The table below lists the values for the dimensions shown in the illustration.

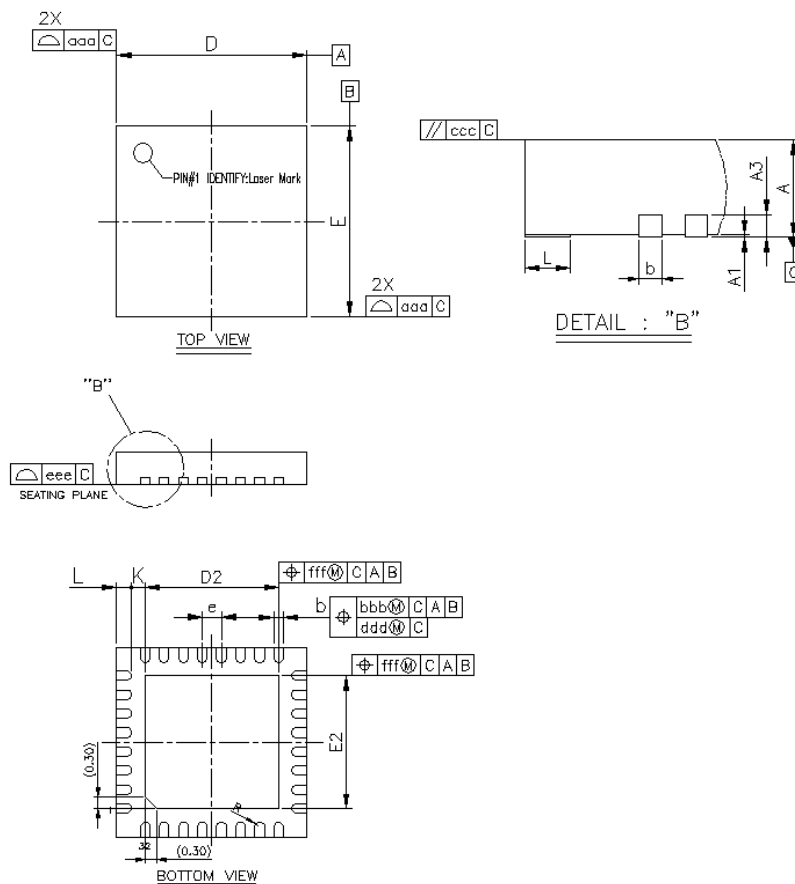

Figure 7.3. 32-Pin Quad Flat No-Lead (QFN)

Table 7.3. Package Dimensions

Dimension	MIN	NOM	MAX
A	0.80	0.85	0.90
A1	0.00	0.02	0.05
A3	0.20 REF		
b	0.18	0.25	0.30
D/E	4.90	5.00	5.10
D2/E2	3.40	3.50	3.60
e	0.50 BSC		
L	0.30	0.40	0.50
K	0.20	---	---
R	0.09	---	0.14
aaa	0.15		
bbb	0.10		
ccc	0.10		

Dimension	MIN	NOM	MAX
ddd		0.05	
eee		0.08	
fff		0.10	

Notes:

1. All dimensions shown are in millimeters (mm) unless otherwise noted.
2. Dimensioning and Tolerancing per ANSI Y14.5M-1994.
3. This drawing conforms to the JEDEC Solid State Outline MO-220, Variation VKKD-4.
4. Recommended card reflow profile is per the JEDEC/IPC J-STD-020 specification for Small Body Components.

8. PCB Land Pattern

8.1 7x7 mm 48-QFN Land Pattern

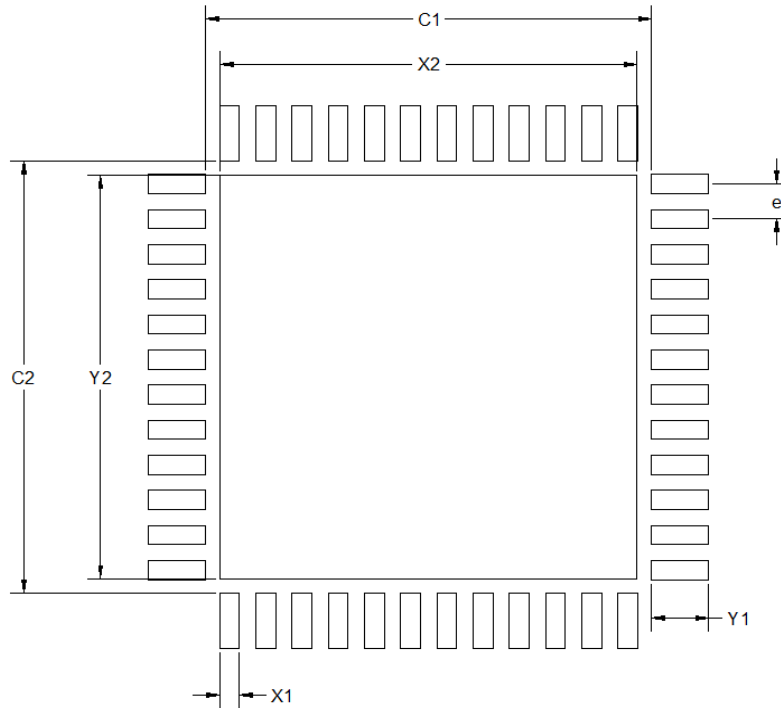

Figure 8.1. 48-QFN Land Pattern

Table 8.1. PCB Land Pattern Dimensions

Dimension	MIN	TYP	MAX
C1	6.05	6.15	6.25
C2	6.05	6.15	6.25
e	0.50 BSC		
X1	0.17	0.25	0.37
Y1	0.69	0.8	0.89
X2	5.65	5.75	5.85
Y2	5.65	5.75	5.85

Dimension	MIN	TYP	MAX
<p>Notes:</p> <p>General</p> <ol style="list-style-type: none"> 1. All dimensions shown are in millimeters (mm) unless otherwise noted. 2. This Land Pattern Design is based on the IPC-7351 guidelines. <p>Solder Mask Design</p> <ol style="list-style-type: none"> 1. All metal pads are to be non-solder mask defined (NSMD). Clearance between the solder mask and the metal pad is to be 60 µm minimum, all the way around the pad. <p>Stencil Design</p> <ol style="list-style-type: none"> 1. A stainless steel, laser-cut and electro-polished stencil with trapezoidal walls should be used to assure good solder paste release. 2. The stencil thickness should be 0.125 mm (5 mils). 3. The ratio of stencil aperture to land pad size can be 1:1 for all perimeter pads. 4. The stencil aperture to center land pad size recommendation is 70% paste coverage. <p>Card Assembly</p> <ol style="list-style-type: none"> 1. A No-Clean, Type-3 solder paste is recommended. 2. The recommended card re-flow profile is per the JEDEC/IPC J-STD-020 specification for Small Body Components. 			

8.2 6x6 mm 40-QFN Land Pattern

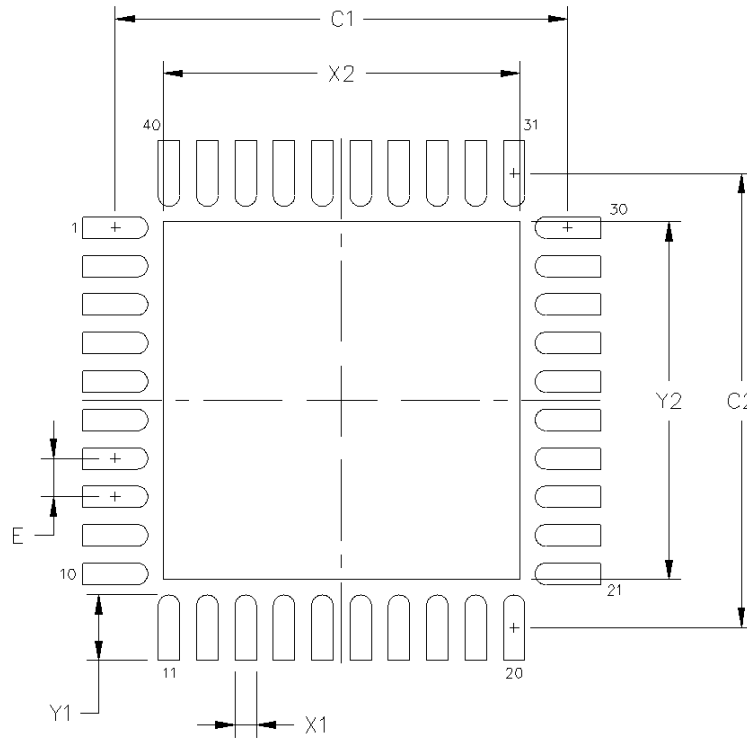

Figure 8.2. 40-QFN Land Pattern

Table 8.2. PCB Land Pattern Dimensions

Dimension	mm
C1	5.90
C2	5.90
e	0.50 BSC
X1	0.30
Y1	0.85
X2	4.65
Y2	4.65

Dimension	mm
<p>Notes:</p> <p>General</p> <ol style="list-style-type: none"> 1. All dimensions shown are in millimeters (mm) unless otherwise noted. 2. This Land Pattern Design is based on the IPC-7351 guidelines. <p>Solder Mask Design</p> <ol style="list-style-type: none"> 1. All metal pads are to be non-solder mask defined (NSMD). Clearance between the solder mask and the metal pad is to be 60 µm minimum, all the way around the pad. <p>Stencil Design</p> <ol style="list-style-type: none"> 1. A stainless steel, laser-cut and electro-polished stencil with trapezoidal walls should be used to assure good solder paste release. 2. The stencil thickness should be 0.125 mm (5 mils). 3. The ratio of stencil aperture to land pad size can be 1:1 for all perimeter pads. 4. The stencil aperture to land pad size recommendation is 70% paste coverage. <p>Card Assembly</p> <ol style="list-style-type: none"> 1. A No-Clean, Type-3 solder paste is recommended. 2. The recommended card reflow profile is per the JEDEC/IPC J-STD-020 specification for Small Body Components. 	

8.3 5x5 mm 32-QFN Land Pattern

The figure below illustrates the PCB land pattern details for Si5332 in 32-QFN package. The table below lists the values for the dimensions shown in the illustration.

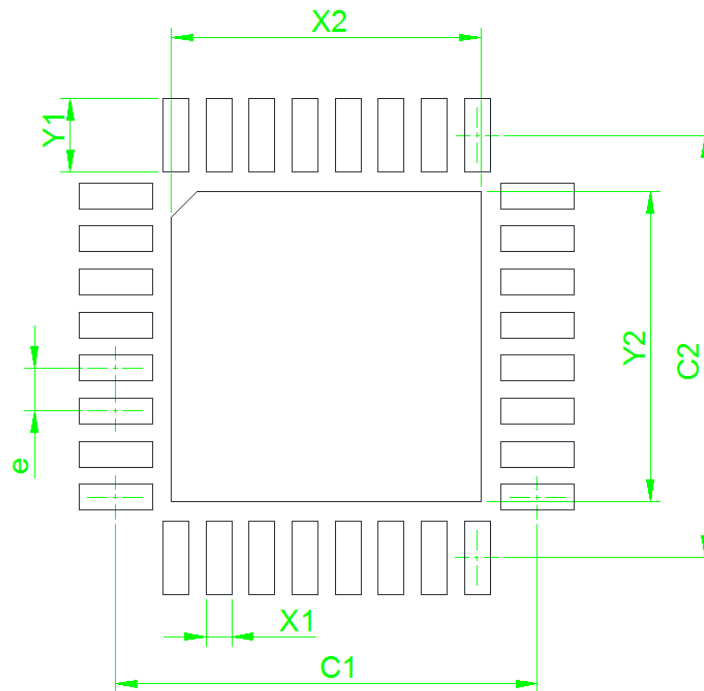

Figure 8.3. 32-QFN Land Pattern

Table 8.3. PCB Land Pattern Dimensions

Dimension	mm
C1	4.90
C2	4.90
e	0.50 BSC
X1	0.30
Y1	0.85
X2	3.60
Y2	3.60

Dimension	mm
<p>Notes:</p> <p>General</p> <ol style="list-style-type: none"> 1. All dimensions shown are in millimeters (mm) unless otherwise noted. 2. This Land Pattern Design is based on the IPC-7351 guidelines. <p>Solder Mask Design</p> <ol style="list-style-type: none"> 1. All metal pads are to be non-solder mask defined (NSMD). Clearance between the solder mask and the metal pad is to be 60 µm minimum, all the way around the pad. <p>Stencil Design</p> <ol style="list-style-type: none"> 1. A stainless steel, laser-cut and electro-polished stencil with trapezoidal walls should be used to assure good solder paste release. 2. The stencil thickness should be 0.125 mm (5 mils). 3. The ratio of stencil aperture to land pad size can be 1:1 for all perimeter pads. 4. The stencil aperture to land pad size recommendation is 70% paste coverage. <p>Card Assembly</p> <ol style="list-style-type: none"> 1. A No-Clean, Type-3 solder paste is recommended. 2. The recommended card reflow profile is per the JEDEC/IPC J-STD-020 specification for Small Body Components. 	

9. Top Marking

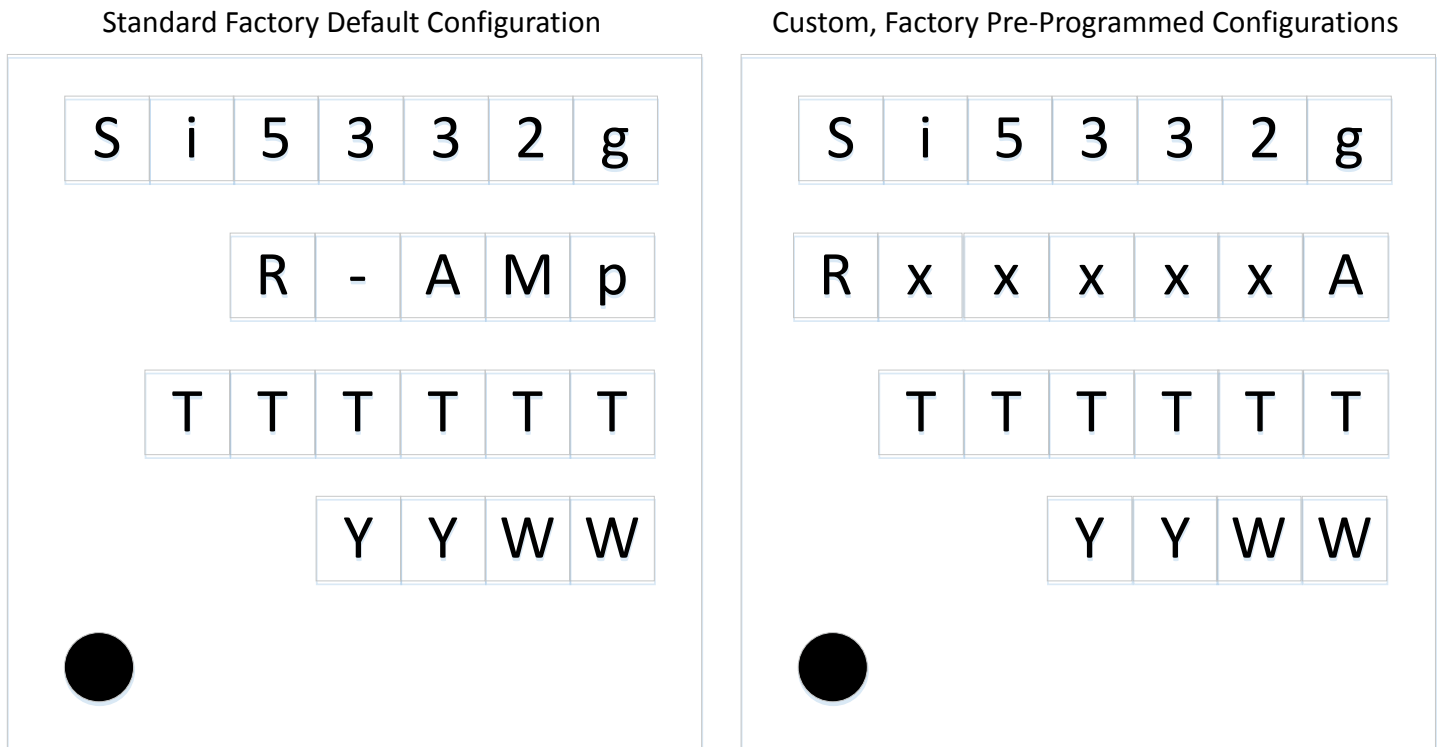

Figure 9.1. Si5332 Top Marking

Table 9.1. Top Marking Explanation

Line	Characters	Description
1	Si5332g	Si5332 = Base part number
		g = Device Grade (A, B, C, D)
2	R-AMp	R = Product revision (see Ordering Guide for current revision)
		- = Dash character
		AM = Automotive grade temperature range (-40 °C to +105 °C) and Package (QFN)
		p = Package Size <ul style="list-style-type: none"> • 1 = 6-output, 32-pin QFN • 2 = 8-output, 40-pin QFN • 3 = 12-output, 48-pin QFN
	RxxxxA	R = product revision
		xxxxx = Customer specific NVM sequence number. NVM code assigned for custom, factory pre-programmed devices using ClockBuilder Pro. See Ordering Guide for more information.
3	TTTTTT	Manufacturing trace code
4	YYWW	Year (YY) and work week (WW) of package assembly

10. Revision History

Revision A

July, 2022

- Added Agile data sheet revision in footer.

Revision 1.1

January, 2021

- Added SmartClock health monitor and fault detection features.
- Added Si5332-AM3 ordering option, 12-output device in 48-QFN package.
- Changed "Inputx" pin names to "Universalx".
- Updated notes in [Table 5.6 Differential Clock Output Specifications on page 26](#).
- Updated max specs in [Table 5.9 Jitter Performance Specifications on page 30](#), [Table 5.10 PCI-Express Clock Outputs \(100 MHz HCSL\) on page 31](#), and [Table 5.11 Fanout Mode Additive Jitter Performance Specifications on page 32](#) based on Si5332-AM3 characterization results.

Revision 1.0

July, 2020

- Added AEC-Q100 qualified.
- Updated Stencil Design notes in [8. PCB Land Pattern](#).
- Added health monitor and fault detection features.
- Added Si5332-AM3 ordering option, 12-output device in 48-QFN package.
- Changed "Inputx" pin names to "Universalx".

Revision 0.7

September, 2019

- Initial release.



ClockBuilder Pro

One-click access to Timing tools, documentation, software, source code libraries & more. Available for Windows and iOS (CBGo only).

skyworksinc.com/CBPro



Portfolio

skyworksinc.com



SW/HW

skyworksinc.com/CBPro

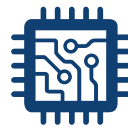

Quality

skyworksinc.com/quality



Support & Resources

skyworksinc.com/support

Copyright © 2022 Skyworks Solutions, Inc. All Rights Reserved.

Information in this document is provided in connection with Skyworks Solutions, Inc. ("Skyworks") products or services. These materials, including the information contained herein, are provided by Skyworks as a service to its customers and may be used for informational purposes only by the customer. Skyworks assumes no responsibility for errors or omissions in these materials or the information contained herein. Skyworks may change its documentation, products, services, specifications or product descriptions at any time, without notice. Skyworks makes no commitment to update the materials or information and shall have no responsibility whatsoever for conflicts, incompatibilities, or other difficulties arising from any future changes.

No license, whether express, implied, by estoppel or otherwise, is granted to any intellectual property rights by this document. Skyworks assumes no liability for any materials, products or information provided hereunder, including the sale, distribution, reproduction or use of Skyworks products, information or materials, except as may be provided in Skyworks' Terms and Conditions of Sale.

THE MATERIALS, PRODUCTS AND INFORMATION ARE PROVIDED "AS IS" WITHOUT WARRANTY OF ANY KIND, WHETHER EXPRESS, IMPLIED, STATUTORY, OR OTHERWISE, INCLUDING FITNESS FOR A PARTICULAR PURPOSE OR USE, MERCHANTABILITY, PERFORMANCE, QUALITY OR NON-INFRINGEMENT OF ANY INTELLECTUAL PROPERTY RIGHT; ALL SUCH WARRANTIES ARE HEREBY EXPRESSLY DISCLAIMED. SKYWORKS DOES NOT WARRANT THE ACCURACY OR COMPLETENESS OF THE INFORMATION, TEXT, GRAPHICS OR OTHER ITEMS CONTAINED WITHIN THESE MATERIALS. SKYWORKS SHALL NOT BE LIABLE FOR ANY DAMAGES, INCLUDING BUT NOT LIMITED TO ANY SPECIAL, INDIRECT, INCIDENTAL, STATUTORY, OR CONSEQUENTIAL DAMAGES, INCLUDING WITHOUT LIMITATION, LOST REVENUES OR LOST PROFITS THAT MAY RESULT FROM THE USE OF THE MATERIALS OR INFORMATION, WHETHER OR NOT THE RECIPIENT OF MATERIALS HAS BEEN ADVISED OF THE POSSIBILITY OF SUCH DAMAGE

Skyworks products are not intended for use in medical, lifesaving or life-sustaining applications, or other equipment in which the failure of the Skyworks products could lead to personal injury, death, physical or environmental damage. Skyworks customers using or selling Skyworks products for use in such applications do so at their own risk and agree to fully indemnify Skyworks for any damages resulting from such improper use or sale.

Customers are responsible for their products and applications using Skyworks products, which may deviate from published specifications as a result of design defects, errors, or operation of products outside of published parameters or design specifications. Customers should include design and operating safeguards to minimize these and other risks. Skyworks assumes no liability for applications assistance, customer product design, or damage to any equipment resulting from the use of Skyworks products outside of Skyworks' published specifications or parameters.



Skyworks, the Skyworks symbol, Sky5®, SkyOne®, SkyBlue™, Skyworks Green™, ClockBuilder®, DSPLL®, ISOMODEM®, PROSLIC®, and SiPHY® are trademarks or registered trademarks of Skyworks Solutions, Inc. or its subsidiaries in the United States and other countries. Third-party brands and names are for identification purposes only and are the property of their respective owners. Additional information, including relevant terms and conditions, posted at www.skyworksinc.com, are incorporated by reference.

Skyworks Solutions, Inc. | Nasdaq: SWKS | sales@skyworksinc.com | www.skyworksinc.com

USA: 781-376-3000 | Asia: 886-2-2735 0399 | Europe: 33 (0)1 43548540

Looking for pricing, stock, or lifecycle information?

Click below to explore more details on WIN SOURCE:

-  [View SI5332D-D-AM1 on WIN SOURCE](#)
-  [Skyworks Solutions Inc. Information](#)

Optimize Your Supply Chain with WIN SOURCE Solutions

-  Global Sourcing Solution
-  Obsolete Management
-  Cost Control Management
-  Shortage Management
-  Alternative Solution
-  Excess Inventory Management