



**THE DATASHEET OF
SPC5516EAMMG66**



MPC5510 Family Product Brief

32-Bit Power Architecture™ Microcontrollers for Body Electronics

The MPC5510 is a new family of next generation microcontrollers built on the Power Architecture.

This document describes the features of the family and the options available on the devices in this family. It also provides some important electrical and physical characteristics of these devices.

The MPC5510 family of 32-bit microcontrollers is Freescale Semiconductor's latest achievement in integrated automotive application controllers. It belongs to an expanding family of automotive-focused products designed to address the next wave of central body and gateway applications within the vehicle. Freescale's advanced and cost efficient host processor core of the MPC5510 automotive controller family is compatible with the Power Architecture Book E architecture. It operates at speeds up to 80 MHz and offers high performance processing optimized for low-power consumption. It capitalizes on the available development infrastructure of the current Power Architecture devices and will be supported with software drivers, operating

Contents

1	Application Examples	2
1.1	Body Controller Application Example	2
1.2	Gateway Application Example	3
2	Features	3
2.1	MPC5510 Family Comparison	3
2.2	Block Diagram	6
2.3	Critical Performance Parameters	7
2.4	Packages	9
2.5	Chip-Level Features	9
2.6	Module Features	10
3	Developer Environment	21

systems, and configuration code to assist with users’ implementations. Refer to [Section 3, “Developer Environment,”](#) for more information.

The MPC5510 platform has a single level of memory hierarchy and can support up to 80 KB of on-chip static random access memory (SRAM) and 1.5 MB of internal flash memory. Refer to [Table 1](#) for specific memory and feature sets of the proposed roadmap product members.

1 Application Examples

The MPC5510 is designed to address the next wave of central body and gateway applications within the vehicle. As shown in the following examples, the MCU is central to the application and provides the flexibility to add or remove peripheral components in a modular design.

1.1 Body Controller Application Example

Body controller modules primarily control interior features of the car, such as:

- Comfort features—doors, seats, interior lighting
- Security/access features—passive entry, immobilizer, TPMS
- Lighting—headlights, brake lights, turn lights
- Centralized diagnostic and network management

[Figure 1](#) shows the MPC551xE/S used in a typical body controller application.

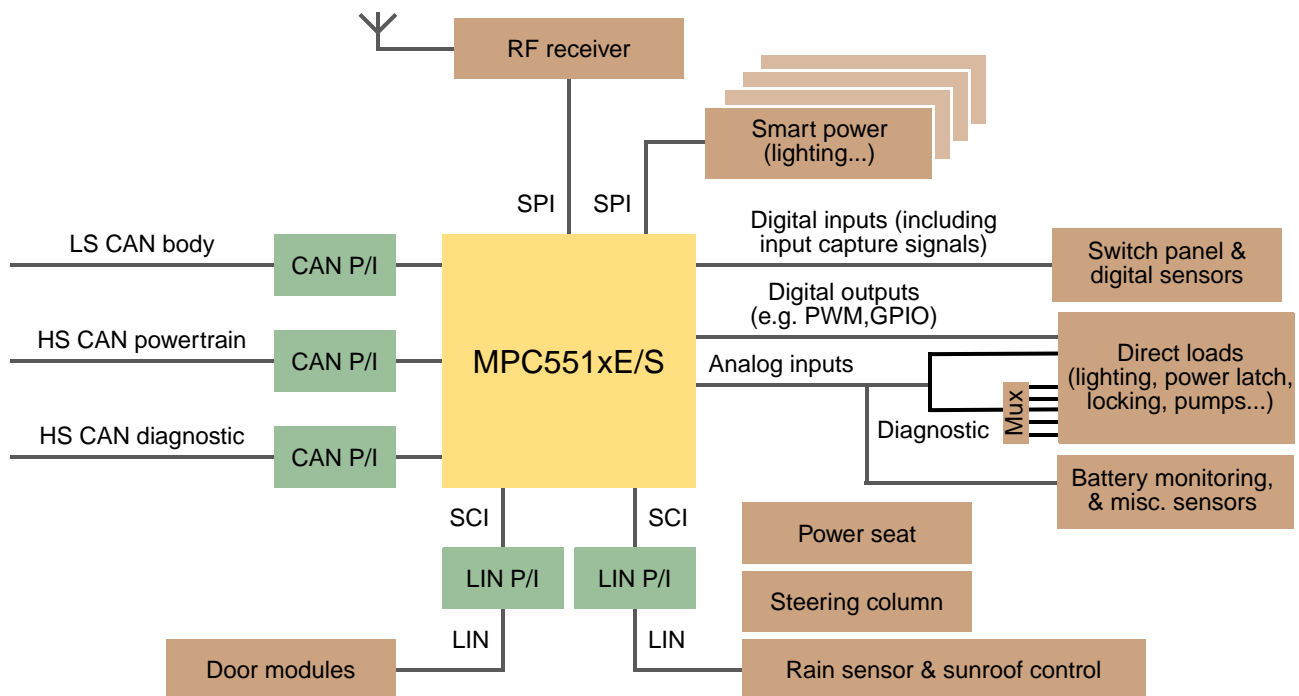

Figure 1. Body Controller Application Example

1.2 Gateway Application Example

Gateway modules are used in highly distributed architectures to route messages between multiple CAN, LIN, and FlexRay buses. They also manage centralized functions, such as diagnostic, power/wakeup management, and module reprogramming.

Figure 2 shows the MPC551xG used in a typical gateway application.

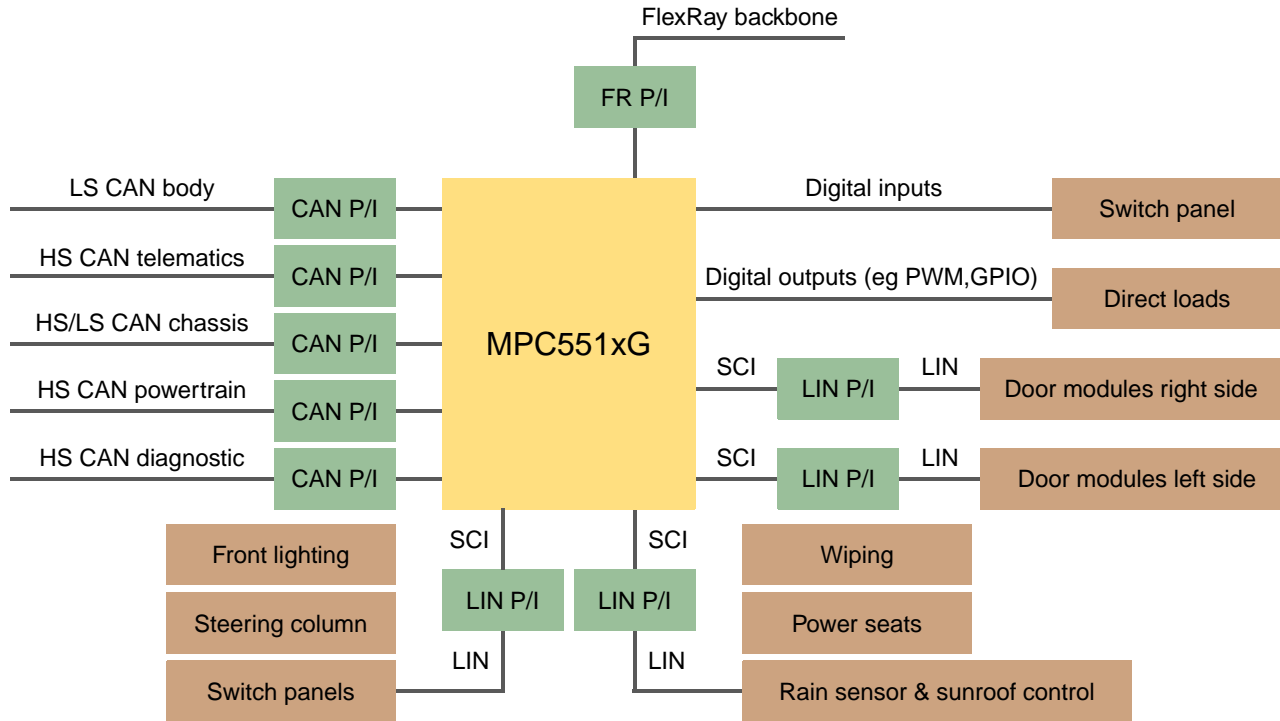

Figure 2. Gateway Application Example

2 Features

This section describes the features of the MPC5510 family.

2.1 MPC5510 Family Comparison

Table 1 provides a summary of the different members of the MPC5510 family and their proposed features. Great flexibility is offered through multiplexing of I/O functionality. The features available will depend on the specific I/O function assignments in the application. Refer to the pinout information in the reference manual for more details.

Table 1. MPC5510 Family Comparison, Maximum Feature Set¹

Feature	MPC5517G	MPC5517E	MPC5517S	MPC5516G	MPC5516E	MPC5516S	MPC5515S	MPC5515S
Package	208-BGA	144-LQFP 208-BGA/ 176-LQFP	144-LQFP 208-BGA/ 176-LQFP	144-LQFP 208-BGA	144-LQFP 208-BGA/ 176-LQFP	144-LQFP 176-LQFP	144-LQFP 176-LQFP	144-LQFP 176-LQFP
Main CPU	e200z1							
Maximum Execution Speed ²	80 MHz at Ta=105C 75 MHz at Ta=125C	80 MHz at Ta=105C 75 MHz at Ta=125C	66 MHz	80 MHz at Ta=105C 75 MHz at Ta=125C	80 MHz at Ta=105C 75 MHz at Ta=125C	66 MHz	66 MHz	66 MHz
Flash ³	1.5 MB	1.5 MB	1.5 MB	1 MB	1 MB	1 MB	768 KB	512 K
RAM	80 KB	80 KB	64 KB	64 KB	64 KB	48 KB	48 KB	64 K
I/O Processor	e200z0	e200z0	—	e200z0	e200z0	—	—	e200z0
DMA	Yes	Yes	Yes	Yes	Yes	Yes	Yes	Yes
MPU	16 entry	16 entry	8 entry	16 entry	16 entry	8 entry	8 entry	16 entry
ADC ⁴	40 channels, 12-bit (16 channels input only; 24 channels bidirectional)							
Total Timed I/O ⁵ eMIOS200	24 channels, 16-bit (8 channels IC/OC; 16 channels PWM, IC/OC)							
Real-Time Clock	ext 32 KHz Crystal	ext 32 KHz Crystal	—	ext 32 KHz Crystal	ext 32 KHz Crystal	—	—	ext 32 KHz Crystal
SCI	6x eSCI	6x eSCI 8x eSCI	6x eSCI	6x eSCI	6x eSCI 8x eSCI	6x eSCI	6x eSCI	6x eSCI
SPI	4x DSPI	4x DSPI	4x DSPI	4x DSPI	4x DSPI	3x DSPI	3x DSPI	3x DSPI
SPI Chip Selects	24	23 ⁶ 24	23 ⁶ 24	23 ⁶ 24	23 ⁶ 24	18	18	18
CAN	6x FlexCAN	5x FlexCAN	4x FlexCAN 5x FlexCAN	6x FlexCAN	5x FlexCAN	4x FlexCAN 5x FlexCAN	4x FlexCAN 5x FlexCAN	6x FlexCAN
FlexRay	Yes	—	—	Yes	—	—	—	Yes
MLB ⁷	Yes	Yes	—	Yes	Yes	—	—	Yes
I ² C	—	—	—	—	—	—	—	—
EBI ⁸	Yes ⁹	Yes ¹⁰ Yes ⁹	Yes ⁹ Yes ¹⁰	Yes ⁹ Yes ¹⁰	Yes ⁹ Yes ¹⁰	Yes ⁹ Yes ¹⁰	Yes ⁹ Yes ¹⁰	Yes ⁹ Yes ¹⁰
GPIO ¹¹	144	111 144/137	111 144/137	111 144/137	111 144/137	111 137	111 137	111 137

NOTES:

- Maximum feature set displayed for each family member. Feature set depends on selected peripheral multiplexing.
- Maximum speed is 66 MHz on 144-LQFP and 176-LQFP package options.
- EEPROM emulation supported by small flash blocks with read-while-write operation as part of main array space.
- ADC channel accuracy greater for input-only channel, bidirectional channels offer the ability for unused channels to be used as outputs.
- IC—input capture; O/C—output compare; PWM—pulse-width modulation.
- For devices with four DSPI modules, in the 144-pin package, it is not possible to bring out all 24 DSPI chip selects. Hence, three modules can have six chip selects, but one module can have only four chip selects.
- MLB is emulated in software and requires the following resources: I/O Processor, 2xDSPI, 4x eDMA channels, RAM, SoftMLB Interface Logic.
- In the 208-pin package, there can be up to 24 address bits with 32-bit data and four chip selects. In the 144-pin and 176-pin packages, there are 24 address bits with 16-bit data and four chip selects.
- 16-bit or 32-bit multiplexed data bus supported. EBI multiplexed with other functions shown as available.
- 16-bit multiplexed data bus supported. EBI multiplexed with other functions shown as available.
- Estimated I/O count for proposed packages based on multiplexing with peripherals.

2.1.1 Family Feature Set Scaling

The MPC5510 family supports multiple functions on most of the pins. This allows flexibility in the positioning and the availability of device features. It is the user's choice what trade-offs are made between the feature set used for the available pin count through this device pin multiplexing. The available features implemented on silicon will be added incrementally as the family functionality increases. [Table 2](#) provides a summary of the flash array address space supported by the different device memory sizes. [Table 3](#) summarizes the RAM array address space supported by the different device memory sizes. [Table 4](#) summarizes the available peripheral functionality of each family member.

Evaluation of the pin list for each device will be necessary, as it may not be possible to retain all modules sequentially, depending on the selected pin multiplexing trade-offs on each device.

NOTE

The RAppID initialization tool provides a pin allocation wizard that will allow you to configure I/O graphically to meet the requirements of the peripheral functions. More information on this tool can be found at <http://www.freescale.com/mpc55xx>.

Table 2. Flash Memory Scaling

Memory Size	Start Address	End Address
1.5 MB	0x0000_0000	0x0017_FFFF
1 MB	0x0000_0000	0x000F_FFFF
768 KB	0x0000_0000	0x000B_FFFF
512 KB	0x0000_0000	0x0007_FFFF

Table 3. RAM Memory Scaling

Memory Size	Start Address	End Address
80 KB	0x4000_0000	0x4001_3FFF
64 KB	0x4000_0000	0x4000_FFFF
48 KB	0x4000_0000	0x4000_BFFF
32 KB	0x4000_0000	0x4000_7FFF

Table 4. Peripheral Scaling

		MPC5517					MPC5516					MPC5515		MPC5514	
		G	E		S		G	E		S		S		G	E
	Package	208	144	176/ 208	144	176	144/208	144	176/ 208	144	176	144	176	144	144
MPU	Regions	16	16	16	8	8	16	16	16	8	8	8	8	16	16
SCI	Number	6	6	8	6	6	6	6	8	6	6	6	6	6	6
	Module	A,B,C,D, E,F	A,B,C,D, E,F	A,B,C,D, E,F,G,H	A,B,C,D, E,F	A,B,C,D, E,F	A,B,C,D, E,F	A,B,C,D, E,F	A,B,C,D, E,F,G,H	A,B,C,D, E,F	A,B,C,D, E,F	A,B,C,D, E,F	A,B,C,D, E,F	A,B,C,D, E,F	A,B,C,D, E,F
SPI	Number	4	4	4	4	4	4	4	4	3	3	3	3	3	4
	Module	A,B,C,D	A,B,C,D	A,B,C,D	A,B,C,D	A,B,C,D	A,B,C,D	A,B,C,D	A,B,C,D	A,B,C	A,B,C	A,B,C	A,B,C	A,B,C	A,B,C,D
CAN	Number	6	5	5	4	5	6	5	5	4	5	4	5	6	5
	Module	A,B,C,D, E,F	A,C,D,E, F	A,C,D,E, F	A,C,D,E	A,C,D,E, F	A,B,C,D, E,F	A,C,D,E, F	A,C,D,E, F	A,C,D,E	A,C,D,E, F	A,C,D,E	A,C,D,E, F	A,C,D,E, F	A,B,C,D, E,F

2.2 Block Diagram

Figure 3 shows a top level block diagram of the MPC5510 family.

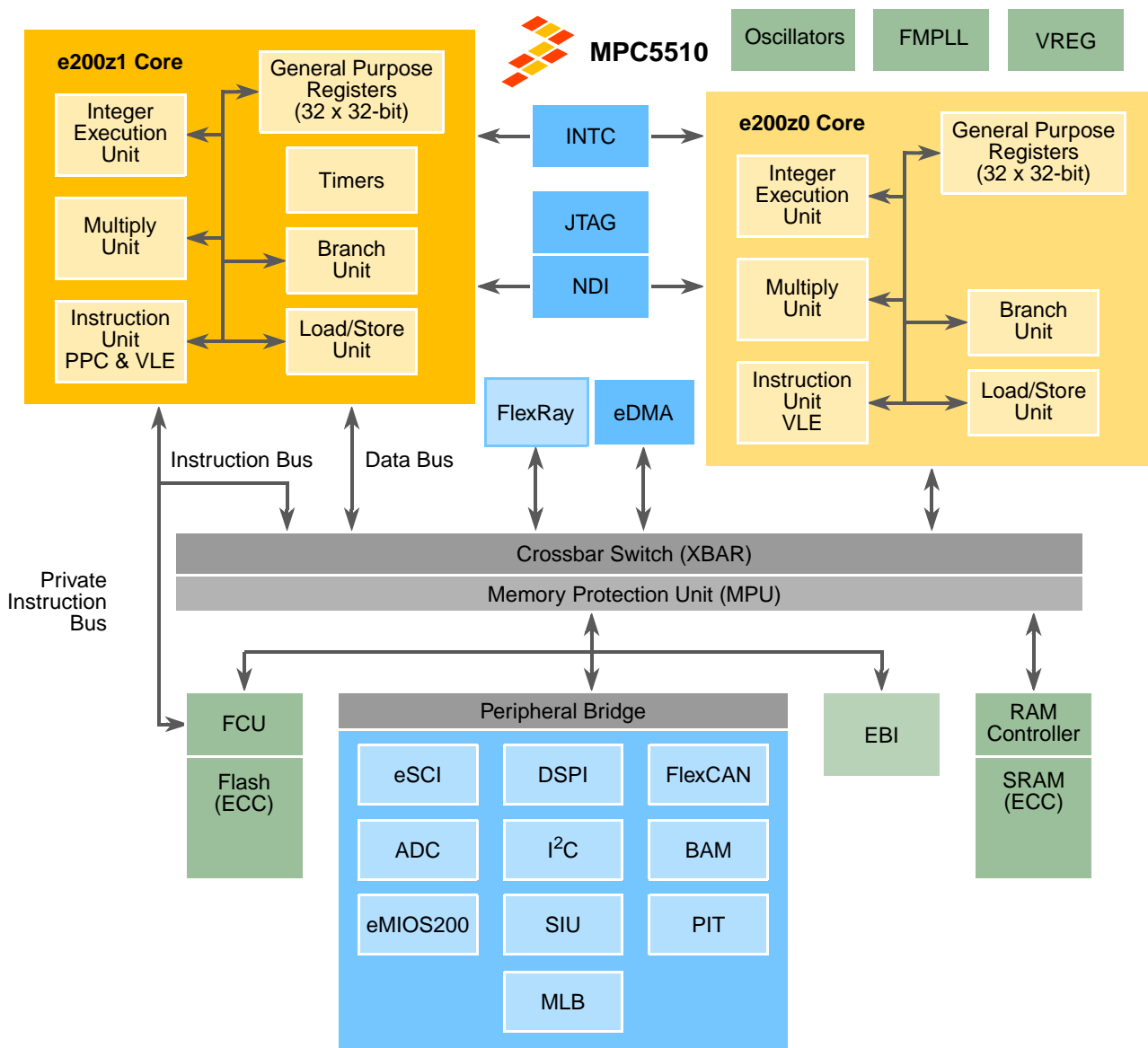

LEGEND

- | | |
|--|---|
| ADC – Analog to Digital Converter modules | FlexRay – Dual Channel FlexRay controller |
| BAM – Boot Assist Module | FMPLL – Frequency Modulated Phase Locked Loop module |
| DSPI – Serial Peripherals Interface controller module | I²C – Inter IC Controller modules |
| EBI – External Bus Interface module | INTC – Interrupt Controller module |
| ECC – Error Correction Code | JTAG – Joint Test Action Group interface |
| eDMA – enhanced Direct Memory Controller module | MLB – Media Local Bus emulation logic |
| eMIOS200 – Timed Input Output module | NDI – Nexus Debug Interface module |
| eSCI – Serial Communications Interface modules | PIT – Periodic Interrupt Timer module |
| FCU – Flash Controller Unit | SIU – System Integration module |
| FlexCAN – Controller Area Network controller modules | VREG – Voltage Regulator |

Figure 3. MPC5510 Family Block Diagram

2.3 Critical Performance Parameters

The critical performance parameters of the MPC5510 feature the following:

- Fully static design operation up to a maximum of 80 MHz
- Low-power design
 - Designed for dynamic power management of core and peripherals

Table 5. Target Device Current Consumption¹

Mode		Description	Condition ²	Typical ³	Units
RUN		Full performance core operating mode with both main core and I/O processor executing	85 °C, 66 MHz	110	mA
STOP		Static mode, with clocks stopped, but power retained to full device	25 °C	600	μA
SLEEP	80K RAM retained	Static mode, with clocks stopped and power disabled to much of the device	25 °C	95	μA
	64K RAM retained		25 °C	81	μA
	32K RAM retained		25 °C	53	μA
	16K RAM retained		25 °C	39	μA
	8K RAM retained		25 °C	32	μA
	No RAM retained		25 °C	25	μA

NOTES:

¹ Values are design targets; all values are estimates until silicon is available and characterization has been performed.

² Based on ambient temperatures with device operating with a typical peripheral implementation.

³ Values do not include I/O current consumption.

- Internal voltage regulator (VREG) enables control with a single input voltage
 - 5 V + 5%, -10% input supply voltage
 - 1.5 V internal logic
- ADC analog supply 5 V + 5%, -10%
- Configurable pins
 - Selectable hysteresis
 - Selectable slew rate control
 - Selectable pullup, pulldown, or no pull on all pins
 - Selectable open drain pin
 - Support for 3.3 V and 5.0 V I/O levels based on I/O supply voltage level (three power domains can be independently supplied)

Table 6. I/O Characteristics, VDDE = 5V

Parameter	Symbol	Value	Equation
Input Voltage High	V _{IH}	3.25 V	VDDE*0.65
Input Voltage Low	V _{IL}	1.75 V	VDDE*0.35
Output Voltage High	V _{OH}	4.0 V	VDDE*0.8V
Output Voltage Low	V _{OL}	1.0 V	VDDE*0.2V
Output Drive Strength ¹	I _{DRV}	2mA	—
I/O DC Injection Current	I _{IC}	± 2mA	—

NOTES:

¹ Refer to the device reference manual and device data sheet for details of allocation of pins capable of stated values and conditions that apply.

- Frequency modulated phase locked loop
- -40 to 150 °C junction temperature

2.3.1 Low Power Operation

The MPC5510 has two dynamic power modes and three static power modes:

- Low-power modes use clock gating to halt the clock for all or part of the device.
- The lowest power modes also use power gating to automatically turn off the power supply to parts of the device to minimize leakage.
- Dynamic power modes are RUN:
 - RUN mode is the main full-performance operating mode where the entire device is powered and clocked. The user can configure the device operating speed through selection of the clock source and the phase-locked loop (FMPLL) frequency. Clock gating can be performed on a peripheral by peripheral basis to select which device features have their clock halted to save power. When implemented, the I/O processor can optionally be enabled, allowing execution of code and access to the memory and peripherals of the device.
- Static power modes are STOP and SLEEP:
 - STOP mode maintains power to the entire device allowing the retention of all on-chip registers and memory, and providing a fast recovery low-power mode with no need to reconfigure the device. The clocks are halted to the cores and peripherals and the crystal oscillator can be optionally enabled in STOP mode to reduce start-up time, but cannot drive the API/RTC when in this mode.
 - STOP is entered from RUN mode. On exiting STOP mode the device returns to the RUN mode.
 - SLEEP mode halts the clock to the entire device and turns off the power to the majority of the chip to offer the lowest power consumption modes of the MPC5510. SLEEP mode retains the output levels on the pins, but power gating means that the contents of the cores, on-chip peripheral registers and some of the volatile memory are not held. The device can be awakened from selected I/O pins, a reset, or from a periodic wakeup using a low-power oscillator. If required by the user, it is possible to enable the internal 16 MHz or 32 KHz RC oscillator, or

an external 32 KHz oscillator. The crystal oscillator can be optionally enabled in SLEEP mode to reduce start-up time. The user can select the desired level of RAM to be retained as the following: full contents of the on-chip PRAM, 80K, 64K, 32K, 16K, 8K, no RAM retained.

- Fast wakeup using the on-chip 16 MHz internal RC oscillator allowing rapid execution on exit from low-power modes.
- 16 MHz internal RC oscillator supports low-speed code execution and clocking of peripherals

2.4 Packages

MPC5510 family members are offered in the following package types:

- 144-pin LQFP, 0.5mm pitch, 20mm x 20mm outline
- 176-pin LQFP, 0.5 mm pitch, 24mm x 24mm outline
- 208-ball MAPBGA, 1mm ball pitch, 17mm x 17mm outline

2.5 Chip-Level Features

On-chip modules available within the family include the following features:

- Single-issue, 32-bit CPU core complex (e200z1)
 - Compliant with the Power Architecture embedded category
 - Includes an instruction set enhancement allowing variable length encoding (VLE) for code size footprint reduction. With the optional encoding of mixed 16-bit and 32-bit instructions, it is possible to achieve significant code-size footprint reduction.
- Up to 1.5 MB of on-chip flash with flash control unit (FCU)
- Up to 80 KB on-chip SRAM
- Memory protection unit (MPU) with up to 16 region descriptors and 32-byte region granularity
- Interrupt controller (INTC) capable of handling selectable-priority interrupt sources
- Frequency modulated Phase-locked loop (FMPLL)
- Crossbar switch architecture for concurrent access to peripherals, flash, or RAM from multiple bus masters
- One 16-channel enhanced direct memory access controller (eDMA)
- Boot assist module (BAM) supports internal flash programming via a serial link (CAN or SCI)
- Timer supports input/output channels providing a range of 16-bit input capture, output compare, and pulse-width modulation functions (eMIOS200)
- One 12-bit analog-to-digital converter (ADC)
- Up to four serial peripheral interface (DSPI) modules
- Up to eight serial communication interface (eSCI) modules
- Up to six enhanced full CAN (FlexCAN) modules with configurable buffers
- One inter IC communication interface (I²C) module
- Up to 144 configurable general-purpose pins supporting input and input/output operations

Features

- Real-time counter (RTC) with clock source from external 32 KHz crystal oscillator, internal 32 KHz or 16 MHz oscillator and supporting wakeup with selectable 1 sec. resolution and >1 hour timeout, or 1 mS resolution with max timeout of 2 sec.
- Up to eight periodic interrupt timers (PIT) with 32-bit counter resolution
- Nexus development interface (NDI) per IEEE-ISTO 5001-2003 Class Two Plus standard
- Device/board test support per joint test action group (JTAG) of IEEE (IEEE 1149.1)
- On-chip voltage regulator (VREG) regulation of input supply for all internal levels
- Optional e200z0, second I/O processor built on Power Architecture technology with VLE instruction set
- Optional FlexRAY controller
- Optional external bus interface (EBI) module
- Optional medial local bus (MLB) interface for communication with off-chip MOST controller

2.6 Module Features

The following sections provide more detailed information on the modules implemented on the MPC5510.

2.6.1 High Performance e200z1 Core Processor

The e200z1 core includes the following features:

- Single-issue four-stage pipelined in-order execution, 32-bit Power Architecture CPU
- Supports the 32-bit Power Architecture Book E programmer's model
- Variable length encoding (VLE) enhancements
 - Allows optional encoding of mixed 16-bit and 32-bit instructions
 - Results in smaller code-size footprint
 - Minimizes impact on performance
- Memory management unit (MMU) with four entry translation look-aside buffer (TLB)
 - MMU provides features such as VLE or Book-E ISA selection and endianness access control
- Branch processing acceleration using lookahead instruction buffer
 - Dedicated branch address calculation adder
 - Branch acceleration using branch lookahead instruction buffer
- Load/store unit
 - One cycle load latency
 - Fully pipelined architecture
 - Misaligned access support
 - No load-to-use pipeline bubbles
- Thirty-two 32-bit general-purpose registers (GPRs)
- Separate instruction bus and load/store bus Harvard architecture
 - Private instruction bus to flash controller

- Hardware or software vectored interrupt support
- Reservation instructions for implementing read-modify-write constructs
- Multi-cycle divide (divw), load multiple (lmw), and store multiple (smw) class instructions; can be interrupted to prevent increases in interrupt latency
- Extensive system development support through Nexus debug port

2.6.2 I/O Processor

The MPC5510's I/O processor features the following:

- The MPC5510 family of devices allows support for flexible implementations, with the option to select whether the main core is running with or without the I/O processor. This allows tuning of performance against power consumption, and can help smooth out performance peaks while running at a lower speeds. Additionally, the I/O processor can execute when the main core is disabled.
- High-performance, low-cost e200z0 core processor for managing peripherals and interrupts
- Single-issue four-stage pipelined in-order execution, 32-bit Power Architecture CPU
- Variable length encoding (VLE), allowing mixed 16-bit and 32-bit instructions
 - Results in smaller code-size footprint
 - Minimizes impact on performance
- Branch processing acceleration using lookahead instruction buffer
- Load/store unit
 - One-cycle load latency
 - Fully pipelined architecture
 - Misaligned access support
 - No load-to-use pipeline bubbles
- Thirty-two 32-bit general purpose registers (GPRs)
- Unified interface into crossbar switch
- Hardware vectored interrupt support
- Reservation instructions for implementing read-modify-write constructs
- Multi-cycle divide (divw), load multiple (lmw), and store multiple (smw) class instructions, can be interrupted to prevent increases in interrupt latency
- Extensive system development support through Nexus debug port

2.6.3 Enhanced Direct Memory Access Controller (eDMA)

The following summarizes the MPC5510's implementation of the eDMA controller:

- 16 channels support independent 8, 16, or 32 bit single-value or block transfers
- Supports variable sized queues and circular queues
- Source and destination address registers are independently configured to post-increment or remain constant

Features

- Each transfer is initiated by a peripheral, CPU, periodic timer interrupt, or eDMA channel request
- Each eDMA channel can optionally send an interrupt request to the CPU on completion of a single value or block transfer
- DMA transfers possible between system memories, SPIs, SCIs, I²C, ADC, eMIOS200, and general purpose I/O
- Programmable DMA channel mux allows assignment of any DMA source to any available DMA channel with up to a total of 64 potential request sources

2.6.4 Crossbar Switch (XBAR)

The following summarizes the MPC5510's implementation of the crossbar switch:

- Up to five master ports
 - Masters: CPU instruction bus, CPU load/store bus, I/O processor bus, FlexRay, and eDMA
- Multiple bus slaves to enable access to flash, SRAM, peripherals, external bus interface (EBI)
- Shared port for crossbar access to flash, peripherals bus, and optional external bus interface
- Private 32-bit wide instruction bus to flash from main CPU
- Crossbar supports up to two consecutive transfers at any one time
- 32-bit internal address bus, 32-bit internal data bus
- Fixed-priority arbitration based on port master
- Temporary dynamic priority elevation of masters

2.6.5 Memory Protection Unit (MPU)

The MPU features the following:

- Up to 16 region descriptors for per master protection
- Start and end address defined with 32-byte granularity
- Overlapping regions supported
- Protection attributes can optionally include process ID
- Protection offered for three concurrent read ports
- Read and write attributes for all masters
- Execute and supervisor/user mode attributes for processor masters

2.6.6 Interrupt Controller (INTC)

The MPC5510 implements an interrupt controller that features the following:

- Unique 9-bit vector for each of the separate interrupt sources
- 8 software-triggerable interrupt sources
- 16 priority levels with fixed hardware arbitration within priority levels for each interrupt source
- Ability to modify the ISR or task priority.

- Modifying the priority can be used to implement the priority ceiling protocol for accessing shared resources
- Interrupt steering between main CPU and I/O processor
 - Independent selection of any interrupt source to be routed through I/O processor
 - Interrupts share same priority level between I/O processor and CPU
- Two external high-priority interrupts directly accessing the main core and IOP critical interrupt mechanism

2.6.7 System Clocks and Clock Generation

The following list summarizes the system clock and clock generation on the MPC5510:

- System clock can be derived from the following sources
 - External oscillator
 - FMPLL
 - 16 MHz internal RC oscillator
- Programmable output clock divider of system clock ($\div 1$, $\div 2$, $\div 4$, $\div 8$)
- Separate programmable peripheral bus clock divider ratio ($\div 1$, $\div 2$, $\div 4$, $\div 8$) applied to system clock
- Frequency modulated Phase-locked loop (FMPLL)
 - Input clock frequency from 4 MHz to 40 MHz
 - Optional frequency modulation
 - Lock detect circuitry continuously monitors lock status
 - Loss-of-clock (LOC) detection for reference and feedback clocks
 - On-chip loop filter (for improved electromagnetic interference performance and reduces number of external components required)
- On-chip crystal oscillator
- Dedicated 16 MHz internal RC oscillator
 - Used as default clock source out of reset (can provide a back-up clock in the event of PLL or external oscillator clock failure)
 - Provides a clock for rapid start-up from low-power modes
 - Offers an independent clock source for the watchdog timer
 - 5% accuracy (after factory trim loaded). Application trim resolution $\pm 0.5\%$
 - Trimming registers to support frequency adjustment with in-application calibration
- Dedicated internal 32 KHz internal RC oscillator for low-power mode operation and self wakeup
- Optional 32 KHz low-power external oscillator for low-power and real-time clock

2.6.8 System Integration Unit (SIU)

The SIU features the following:

- Up to four levels of internal pin multiplexing, allowing exceptional flexibility in the allocation of device functions for each package
- Centralized general-purpose input/output (GPIO) control of up to 144 input/output pins
- All GPIO pins can be independently configured to support pullup, pulldown, no pull, or slew rate and hysteresis
- Reading and writing to GPIO supported both as individual pins and 16-bit wide ports
- All peripheral pins, except selected ADC channels, can be alternatively configured as general-purpose input/output pins
- All ADC channels can be alternatively configured as general-purpose inputs, with some pins also able to support outputs
- Direct readback of the pin value supported on all digital output pins through the SIU
- Configurable digital input filter that can be applied to some general-purpose input pins for noise elimination
- Multiple independent I/O power domains
 - Supports independent, non 5 V supply levels from external voltage regulators
 - I/O support for 3.3 V or 5 V levels

2.6.9 Watchdog

The watchdog on the MPC5510 features the following:

- Watchdog supporting software activation or enabled out of reset
 - Supports normal or windowed mode
 - Watchdog timer value writable once after reset
 - Watchdog supports optional halting during debug
 - Configurable response on timeout: reset, interrupt, or interrupt followed by reset
- Selectable clock source for main system clock or internal RC oscillator clock

2.6.10 On-Chip Flash

On-chip flash on the MPC5510 features the following:

- Burst flash memory
 - Dual-ported system bus connection
 - Private 32-bit instruction bus from main processor core
 - 32-bit bus shared for main processor data accesses and other bus masters through crossbar
 - Two independent sets of 4 x 128-bit page buffers with programmable prefetch control
 - Typical flash access time: zero wait-state for buffer hits, two wait-states for page buffer miss at 80 MHz

- Page buffers can be allocated for code only, fixed partitions of code and data, all available for any access
- 64-bit ECC with single-bit correction, double-bit detection for data integrity
- Censorship protection scheme to prevent flash content visibility
- Hardware read-while-write feature that allows blocks to be erased/programmed while other blocks are being read (used for EEPROM emulation and data calibration)
- Lowest flash address space configured with ten blocks over three partitions ($4 \times 16\text{K} + 4 \times 16\text{K} + 2 \times 64\text{K}$ bytes) to support features such as boot block, operating system block, and EEPROM emulation
- Hardware programming state machine

2.6.11 On-Chip SRAM

On-chip SRAM on the MPC5510 features the following:

- General-purpose RAM
- Typical SRAM access time: zero wait-state for reads and 32-bit writes; one wait-state for 8- and 16-bit writes if back to back with a read to same memory block
- 32-bit ECC with single-bit correction, double bit detection for data integrity
- Supports byte (8-bit), halfword (16-bit), and word (32-bit) writes for optimal use of memory
- User transparent ECC encoding and decoding for byte, halfword, and word accesses
- Separate internal power domains allow 80 KB, 64 KB, 32 KB, 16 KB, 8 KB of RAM to remain powered (contents retained) during sleep mode

2.6.12 Boot Assist Module (BAM)

The MPC5510's BAM is implemented as follows:

- Enables and manages the transition of MCU from reset to user code execution
- Configures device to support code download via FlexCAN or eSCI and its execution, for end of line programming support
- Multiple bootcode starting locations out of reset through implementation of search for valid reset configuration halfword
- Configurable enable or disable of watchdog out of reset through BAM read of reset configuration halfword option bit

2.6.13 Enhanced Modular Input Output System (eMIOS200)

The MPC5510 implements a scaled down version of the eMIOS module:

- Up to 24 timed I/O channels with 16-bit counter resolution
 - Seven channels offering single-action capture/compare channels
 - One channel offering single-action capture/compare channels and modulus up and down counters to support driving the local and global counter busses

Features

- 16 channels offering dual-action operation with output pulse width modulation (PWM), capture/compare capability and modulus up and down counters
- Buffered updates
- Edge-aligned or center-aligned output pulse width modulation
 - Programmable pulse period and duty cycle
 - Supports 0% and 100% duty cycle
 - Shared or independent time bases
- Programmable phase shift between channels

2.6.14 Analog to Digital Converter Module (ADC)

The ADC features the following:

- 12-bit resolution
- 0–5 V common mode conversion range
- Up to 40 single-ended input channels, expandable with external multiplexers
- Conversions speeds of up to 800K samples/second possible
- Conversion calibration supported through dedicated hardware MAC
- Internal conversion triggering from periodic interrupt timer (PIT) or timed I/O module (eMIOS)
- Six conversion command and result queues with up to four deep FIFOs supporting prioritized conversions
- Complex queuing supported through I/O processor
- Optional conversion timestamp
- All unused analog pins available as general purpose input pins
- Selected unused analog pins available as general purpose input/output pins

2.6.15 Deserial Serial Peripheral Interface Module (DSPI)

The DSPI features the following:

- Up to four DSPI modules supported
- Full-duplex, synchronous transfers
- Master or slave operation
- Programmable master bit rates
- Programmable clock polarity and phase
- End-of-transmission interrupt flag
- Programmable transfer baud rate
- Programmable data frames from 4 to 16 bits
- Up to six chip select lines available, depending on package and pin multiplexing, allowing 64 external devices to be selected using external multiplexing from a single DSPI

- Up to eight independently configurable transfer types can be configured for each DSPI using the clock and transfer attributes registers
- Chip-select strobe available as alternate function on one of the chip-select pins for de-glitching
- FIFOs for buffering up to four transfers on both the transmit and receive side
- Queueing operation possible through use of the I/O processor or eDMA
- Supports serialization of eMIOS200 channels
- General-purpose I/O functionality on pins when not used for SPI

2.6.16 Serial Communication Interface Module (eSCI)

The eSCI on the MPC5510 features the following:

- Up to eight eSCI modules supported
- LIN state machine and UART operating modes
- LIN state machine compliant to LIN1.3, LIN2.0, and LIN2.1 specifications
- LIN master mode state machine
 - Supports generation of LIN message header
 - Detection and flagging of LIN errors
 - Classic or extended checksum calculation
 - Supports autonomous LIN frame handling when combined with eDMA
- UART operating mode
 - Standard non-return-to-zero (NRZ) mark/space format
 - Full-duplex operation
 - Software selectable word length (8-bit or 9-bit words)
 - 10/11- or 13/14-bit break character possible
 - 13-bit programmable baud rate modulus counter
 - Separately enabled transmitter and receiver
 - Separate receiver and transmitter CPU interrupt requests
 - Programmable transmitter output polarity
 - Two receiver wakeup methods
 - Interrupt-driven operation with eight flags
 - Receiver framing error detection
 - Hardware parity checking
 - 1/16 bit time noise reduction

2.6.17 Controller Area Network Module (FlexCAN)

The enhanced FlexCAN module features the following:

- Up to six FlexCAN modules supported
 - Full implementation of the CAN protocol specification, version 2.0B

Features

- 64 mailboxes, each configurable as transmit or receive
 - Mailboxes configurable while module remains synchronized to CAN bus
- Transmit features
 - Supports configuration of multiple mailboxes to form message queues of scalable depth
 - Arbitration scheme according to message ID, message buffer number, or local buffer priority
 - Internal arbitration to guarantee no inner or outer priority inversion
 - Transmit abort procedure and notification
- Receive features
 - Individual programmable filters for each mailbox
 - Eight mailboxes optionally configurable as a six-entry receive FIFO
 - Eight programmable acceptance filters for receive FIFO
- Programmable clock source
 - System clock
 - Direct oscillator clock to avoid PLL jitter
- Listen-only mode capabilities
- Configurable to disable reception of modules own transmitted messages to reduce interrupt loading

2.6.18 Inter IC Communications Module (I²C)

The I²C module features the following:

- One I²C module supported
- Two-wire bidirectional serial bus for on-board communications
- Compatibility with I²C bus standard
- Multimaster operation
- Software-programmable for one of 256 different serial clock frequencies
- Software-selectable acknowledge bit
- Interrupt-driven, byte-by-byte data transfer
- Arbitration-lost interrupt with automatic mode switching from master to slave
- Calling address identification interrupt
- Start and stop signal generation/detection
- Repeated START signal generation
- Acknowledge bit generation/detection
- Bus-busy detection

2.6.19 Dual-Channel FlexRay Controller

The dual-channel FlexRay controller features the following:

- Optionally supported module
- Full implementation of FlexRay Protocol Specification 2.1

- 64 configurable message buffers can be handled
- Message buffers configurable as Tx, Rx, or RxFIFO
- Message buffer size configurable
- Message filtering for all message buffers based on FrameID, cycle count, and message ID
- Programmable acceptance filters for RxFIFO message buffers
- Dual channel, each at up to 10 Mbit/s data rate

2.6.20 Media Local Bus Module (MLB)

The media local bus module features the following:

- Optionally supported module
- 3-pin or 5-pin interface
- 256Fs operation
- External level shift control signals for 3-pin interface
- Multiple pin out options to increase flexibility
- MLBCLK clock adjust
- Visibility of debug signals

2.6.21 External Bus Interface (EBI)

The external bus interface features the following:

- Optionally supported module
- Up to 16 MB of external byte-addressable space with 24-bit address bus
- Address, data multiplexed bus with 16 or 32 data lines and 24 address lines, package dependent
- 8-bit, 16-bit, or 32-bit transfers supported
- Support for internal auto-termination or external termination
- Up to four programmable chip-selects

2.6.22 Periodic Interrupt Timer Module (PIT)

The PIT features the following:

- Up to eight general-purpose interrupt timers
- Up to two dedicated interrupt timers for triggering ADC conversions
- 32-bit counter resolution
- Clocked by system clock frequency
- 32-bit counter for real-time interrupt, clocked from main external oscillator

2.6.23 Real-Time Counter

Real-time counter supports wakeup from low-power modes or real-time clock generation

Features

- 32-bit counter, supporting maximum timeouts of up to 1.5 months with 1 mS resolution
- Configurable resolution for different timeout periods optimized for low-power operation using different comparator banks
 - 12-bit comparator: 1 second resolution for >1 hour period
 - 10-bit comparator: 1 millisecond resolution for 1 second period
- Selectable clock sources from external 32 KHz crystal, internal 32 KHz RC oscillator, 16 MHz RC oscillator, or divided internal 16 MHz RC oscillator
 - 16 MHz RC with fixed divide by 512 before input to real-time counter to prevent rapid time-out

2.6.24 Nexus Development Interface (NDI)

Nexus features the following:

- Per IEEE-ISTO 5001-2003
- Nexus 2 Plus features supported
 - Static debug
 - Watchpoint messaging
 - Ownership trace messaging
 - Program trace messaging
 - Real-time read/write of any internally memory mapped resources through JTAG pins
 - Overrun control, which selects whether to stall before Nexus overruns or keep executing and allow overwrite of information
 - Watchpoint triggering, watchpoint triggers program tracing
- Configured via the IEEE 1149.1 (JTAG) port
- Narrow auxiliary Nexus port supporting support trace, with four MDO pins
- Wide auxiliary Nexus port supporting higher bandwidth trace, with eight MDO pins
- Cross triggering between the main core and the I/O processor allows support for low-skid halting of one CPU as a result of a breakpoint match set on the other CPU
- Synchronous start and stop control of main core and I/O Processor

2.6.25 IEEE 1149.1 JTAG controller (JTAGC)

JTAG features:

- IEEE 1149.1-2001 test access port (TAP) interface
- Supporting boundary scan testing

2.6.26 On-Chip Voltage Regulator (VREG)

The MPC5510's on-chip voltage regulator includes the following features:

- Regulates 5 V input to generate internal 3.3 V and 1.5 V supplies for internal control
- Manages power gating

- Low-power regulators supports operation when in STOP and SLEEP modes to minimize power consumption
- Fast start-up on-chip regulators for rapid exit of low-power modes
- Low-voltage reset supported on all supplies
- Low-voltage interrupt supported on external supply

3 Developer Environment

The MPC5510 family of MCUs supports similar tools and third party developers as other Freescale MPC5500 products, offering a widespread, established network of tools and software vendors. It also features a high-performance Nexus debug interface.

The following development support is available.

- Automotive evaluation boards (EVB) featuring CAN, LIN interfaces, and more
- Compilers
- Debuggers
- JTAG and Nexus interfaces
- RAppID Initialization tool

The following software support will be available:

- OSEK solutions will be available from multiple third parties
- FlexRAY, CAN and LIN drivers
- AUTOSAR package including OS, MCAL, and communication drivers
- Standard software routines available for I/O processor
- MLB emulation software driver

How to Reach Us:

Home Page:

www.freescale.com

Web Support:

<http://www.freescale.com/support>

USA/Europe or Locations Not Listed:

Freescale Semiconductor, Inc.
 Technical Information Center, EL516
 2100 East Elliot Road
 Tempe, Arizona 85284
 +1-800-521-6274 or +1-480-768-2130
www.freescale.com/support

Europe, Middle East, and Africa:

Freescale Halbleiter Deutschland GmbH
 Technical Information Center
 Schatzbogen 7
 81829 Muenchen, Germany
 +44 1296 380 456 (English)
 +46 8 52200080 (English)
 +49 89 92103 559 (German)
 +33 1 69 35 48 48 (French)
www.freescale.com/support

Japan:

Freescale Semiconductor Japan Ltd.
 Headquarters
 ARCO Tower 15F
 1-8-1, Shimo-Meguro, Meguro-ku,
 Tokyo 153-0064
 Japan
 0120 191014 or +81 3 5437 9125
support.japan@freescale.com

Asia/Pacific:

Freescale Semiconductor China Ltd.
 Exchange Building 23F
 No. 118 Jianguo Road
 Chaoyang District
 Beijing 100022
 China
 +86 010 5879 8000
support.asia@freescale.com

For Literature Requests Only:

Freescale Semiconductor Literature Distribution Center
 P.O. Box 5405
 Denver, Colorado 80217
 1-800-441-2447 or 303-675-2140
 Fax: 303-675-2150
LDCForFreescaleSemiconductor@hibbertgroup.com

Document Number: MPC5510PB

Rev. 2
 5/2008

Information in this document is provided solely to enable system and software implementers to use Freescale Semiconductor products. There are no express or implied copyright licenses granted hereunder to design or fabricate any integrated circuits or integrated circuits based on the information in this document.

Freescale Semiconductor reserves the right to make changes without further notice to any products herein. Freescale Semiconductor makes no warranty, representation or guarantee regarding the suitability of its products for any particular purpose, nor does Freescale Semiconductor assume any liability arising out of the application or use of any product or circuit, and specifically disclaims any and all liability, including without limitation consequential or incidental damages. "Typical" parameters that may be provided in Freescale Semiconductor data sheets and/or specifications can and do vary in different applications and actual performance may vary over time. All operating parameters, including "Typicals", must be validated for each customer application by customer's technical experts. Freescale Semiconductor does not convey any license under its patent rights nor the rights of others. Freescale Semiconductor products are not designed, intended, or authorized for use as components in systems intended for surgical implant into the body, or other applications intended to support or sustain life, or for any other application in which the failure of the Freescale Semiconductor product could create a situation where personal injury or death may occur. Should Buyer purchase or use Freescale Semiconductor products for any such unintended or unauthorized application, Buyer shall indemnify and hold Freescale Semiconductor and its officers, employees, subsidiaries, affiliates, and distributors harmless against all claims, costs, damages, and expenses, and reasonable attorney fees arising out of, directly or indirectly, any claim of personal injury or death associated with such unintended or unauthorized use, even if such claim alleges that Freescale Semiconductor was negligent regarding the design or manufacture of the part.

RoHS-compliant and/or Pb-free versions of Freescale products have the functionality and electrical characteristics as their non-RoHS-compliant and/or non-Pb-free counterparts. For further information, see <http://www.freescale.com> or contact your Freescale sales representative.

For information on Freescale's Environmental Products program, go to <http://www.freescale.com/epp>.

Freescale™ and the Freescale logo are trademarks of Freescale Semiconductor, Inc. All other product or service names are the property of their respective owners. The Power Architecture and Power.org word marks and the Power and Power.org logos and related marks are trademarks and service marks licensed by Power.org.

© Freescale Semiconductor, Inc. 2007, 2008. All rights reserved.



Looking for pricing, stock, or lifecycle information?

Click below to explore more details on WIN SOURCE:

 [View SPC5516EAMMG66 on WIN SOURCE](#)

 [NXP / Nexperia Information](#)

Optimize Your Supply Chain with WIN SOURCE Solutions

-  Global Sourcing Solution
-  Obsolete Management
-  Cost Control Management
-  Shortage Management
-  Alternative Solution
-  Excess Inventory Management