



**THE DATASHEET OF
R5F10268ASP#55**



RL78/G12 RENESAS MCU

R01DS0193EJ0240
Rev.2.40
Mar 29, 2024

True low-power platform (63 μ A/MHz) for the general-purpose applications, with 1.8-V to 5.5-V operation, 2- to 16-Kbyte code flash memory, and 31 DMIPS at 24 MHz

1. OUTLINE

1.1 Features

Ultra-low power consumption technology

- V_{DD} = single power supply voltage of 1.8 to 5.5 V which can operate at a low voltage
- HALT mode
- STOP mode
- SNOOZE mode

RL78 CPU core

- CISC architecture with 3-stage pipeline
- Minimum instruction execution time: Can be changed from high speed (0.04167 μ s: @ 24 MHz operation with high-speed on-chip oscillator) to ultra-low speed (1 μ s: @ 1 MHz operation)
- Address space: 1 MB
- General-purpose registers: (8-bit register x 8) x 4 banks
- On-chip RAM: 256 B to 2 KB

Code flash memory

- Code flash memory: 2 to 16 KB
- Block size: 1 KB
- Prohibition of block erase and rewriting (security function)
- On-chip debug function
- Self-programming (with flash shield window function)

Data flash memory ^{Note2}

- Data flash memory: 2 KB
- Back ground operation (BGO): Instructions are executed from the program memory while rewriting the data flash memory.
- Number of rewrites: 1,000,000 times (TYP.)
- Voltage of rewrites: V_{DD} = 1.8 to 5.5 V

High-speed on-chip oscillator

- Select from 24 MHz, 16 MHz, 12 MHz, 8 MHz, 6 MHz, 4 MHz, 3 MHz, 2 MHz, and 1 MHz
- High accuracy: $\pm 1.0\%$ (V_{DD} = 1.8 to 5.5 V, T_A = -20 to +85 $^{\circ}$ C)

Operating ambient temperature

- T_A = -40 to +85 $^{\circ}$ C (A: Consumer applications, D: Industrial applications)
- T_A = -40 to +105 $^{\circ}$ C (G: Industrial applications) ^{Note2}

Power management and reset function

- On-chip power-on-reset (POR) circuit
- On-chip voltage detector (LVD) (Select interrupt and reset from 12 levels)

DMA (Direct Memory Access) controller ^{Note2}

- 2 channels
- Number of clocks during transfer between 8/16-bit SFR and internal RAM: 2 clocks

Multiplier and divider/multiply-accumulator

- 16 bits x 16 bits = 32 bits (Unsigned or signed)
- 32 bits x 32 bits = 32 bits (Unsigned)
- 16 bits x 16 bits + 32 bits = 32 bits (Unsigned or signed)

Serial interface

- Simplified SPI (CSI ^{Note1}): : 1 to 3 channels
- UART : 1 to 3 channels
- Simplified I²C communication : 0 to 3 channels
- I²C communication : 1 channel

Timer

- 16-bit timer : 4 to 8 channels
- 12-bit interval timer : 1 channel
- Watchdog timer : 1 channel (operable with the dedicated low-speed on-chip oscillator)

A/D converter

- 8/10-bit resolution A/D converter (V_{DD} = 1.8 to 5.5 V)
- 8 to 11 channels, internal reference voltage (1.45 V), and temperature sensor ^{Note2}

I/O port

- I/O port: 18 to 26
(N-ch open drain I/O [withstand voltage of 6 V]: 2, N-ch open drain I/O [V_{DD} withstand voltage]: 4 to 9)
- Can be set to N-ch open drain, TTL input buffer, and on-chip pull-up resistor
- Different potential interface: Can connect to a 1.8/2.5/3 V device
- On-chip key interrupt function
- On-chip clock output/buzzer output controller

Others

- On-chip BCD (binary-coded decimal) correction circuit

Note 1. Although the CSI function is generally called SPI, it is also called CSI in this product, so it is referred to as such in this manual.

Note 2. Can be selected only in HS (high-speed main) mode.

Remark The functions mounted depend on the product. See **1.7 Outline of Functions**.

O ROM, RAM capacities

Code flash	Data flash	RAM	20 pins	24 pins	30 pins
16 KB	2 KB	2 KB	–	–	R5F102AA
	–		–	–	R5F103AA
	2 KB	1.5 KB	R5F1026A ^{Note 1}	R5F1027A ^{Note 1}	–
	–		R5F1036A ^{Note 1}	R5F1037A ^{Note 1}	–
12 KB	2KB	1 KB	R5F10269 ^{Note 1}	R5F10279 ^{Note 1}	R5F102A9
	–		R5F10369 ^{Note 1}	R5F10379 ^{Note 1}	R5F103A9
8 KB	2 KB	768 B	R5F10268 ^{Note 1}	R5F10278 ^{Note 1}	R5F102A8
	–		R5F10368 ^{Note 1}	R5F10378 ^{Note 1}	R5F103A8
4 KB	2KB	512 B	R5F10267	R5F10277	R5F102A7
	–		R5F10367	R5F10377	R5F103A7
2 KB	2 KB	256 B	R5F10266 ^{Note 2}	–	–
	–		R5F10366 ^{Note 2}	–	–

- Notes**
1. This is 640 bytes when the self-programming function or data flash function is used. (For details, see **CHAPTER 3 CPU ARCHITECTURE** in the RL78/G12 User's Manual.)
 2. The self-programming function cannot be used for R5F10266 and R5F10366.

Caution When the flash memory is rewritten via a user program, the code flash area and RAM area are used because each library is used. When using the library, refer to RL78 Family Flash Self Programming Library Type01 User's Manual and RL78 Family Data Flash Library Type04 User's Manual.

1.2 List of Part Numbers

<R>

Figure 1-1. Part Number, Memory Size, and Package of RL78/G12



- Notes**
1. For details about the differences between the R5F102 products and the R5F103 products of RL78/G12, see **1.3 Differences between the R5F102 Products and the R5F103 Products**.
 2. Products only for “A: Consumer applications (T_A = -40 to +85°C)” and “D: Industrial applications (T_A = -40 to +85°C)”

Table 1-1. List of Ordering Part Numbers

Pin count	Package	Data flash	Fields of Application <small>Note</small>	Ordering Part Number		RENESAS Code
				Product Name	Packaging Specifications	
<R>	20-pin plastic LSSOP (4.4 × 6.5 mm, 0.65-mm pitch)	Mounted	A	R5F1026AASP, R5F10269ASP, R5F10268ASP, R5F10267ASP, R5F10266ASP	#V5, #35, #X5, #55	PLSP0020JB-A
			D	R5F1026ADSP, R5F10269DSP, R5F10268DSP, R5F10267DSP, R5F10266DSP		
			G	R5F1026AGSP, R5F10269GSP, R5F10268GSP, R5F10267GSP, R5F10266GSP		
		Not mounted	A	R5F1036AASP, R5F10369ASP, R5F10368ASP, R5F10367ASP, R5F10366ASP	#V5, #35, #X5, #55	PLSP0020JB-A
			D	R5F1036ADSP, R5F10369DSP, R5F10368DSP, R5F10367DSP, R5F10366DSP		
		20-pin plastic TSSOP (4.4 × 6.5 mm, 0.65-mm pitch)	Mounted	A	R5F1026AASM, R5F10269ASM, R5F10268ASM, R5F10267ASM, R5F10266ASM	#15, #35, #55, #75
G	R5F1026AGSM, R5F10269GSM, R5F10268GSM, R5F10267GSM, R5F10266GSM					
Not mounted	A			R5F1036AASM, R5F10369ASM, R5F10368ASM, R5F10367ASM, R5F10366ASM		
<R>	24-pin plastic HWQFN (4 × 4 mm, 0.5-mm pitch)	Mounted	A	R5F1027AANA, R5F10279ANA, R5F10278ANA, R5F10277ANA	#U5, #W5	PWQN0024KE-A
				R5F1027AANA, R5F10279ANA, R5F10278ANA, R5F10277ANA	#05, #25, #45, #65	PWQN0024KF-A PWQN0024KH-A
				R5F1027ADNA, R5F10279DNA, R5F10278DNA, R5F10277DNA	#U5, #W5	PWQN0024KE-A
			G	R5F1027AGNA, R5F10279GNA, R5F10278GNA, R5F10277GNA	#05, #25, #45, #65	PWQN0024KF-A PWQN0024KH-A
				R5F1027AGNA, R5F10279GNA, R5F10278GNA, R5F10277GNA		
				R5F1027AGNA, R5F10279GNA, R5F10278GNA, R5F10277GNA		
		Not mounted	A	R5F1037AANA, R5F10379ANA, R5F10378ANA, R5F10377ANA	#U5, #W5	PWQN0024KE-A
				R5F1037AANA, R5F10379ANA, R5F10378ANA, R5F10377ANA	#05, #25, #45, #65	PWQN0024KF-A PWQN0024KH-A
				R5F1037ADNA, R5F10379DNA, R5F10378DNA, R5F10377DNA	#U5, #W5	PWQN0024KE-A
			D	R5F1037ADNA, R5F10379DNA, R5F10378DNA, R5F10377DNA	#U5, #W5	PWQN0024KE-A
				R5F1037ADNA, R5F10379DNA, R5F10378DNA, R5F10377DNA		
				R5F1037ADNA, R5F10379DNA, R5F10378DNA, R5F10377DNA		
<R>	30-pin plastic LSSOP (7.62 mm (300), 0.65-mm pitch)	Mounted	A	R5F102AAASP, R5F102A9ASP, R5F102A8ASP, R5F102A7ASP	#V0, #10, #30, #X0, #50, #70	PLSP0030JB-B
			D	R5F102AADSP, R5F102A9DSP, R5F102A8DSP, R5F102A7DSP		
			G	R5F102AAGSP, R5F102A9GSP, R5F102A8GSP, R5F102A7GSP		
		Not mounted	A	R5F103AAASP, R5F103A9ASP, R5F103A8ASP, R5F103A7ASP	#V0, #10, #30, #X0, #50, #70	PLSP0030JB-B
			D	R5F103AADSP, R5F103A9DSP, R5F103A8DSP, R5F103A7DSP		
			D	R5F103AADSP, R5F103A9DSP, R5F103A8DSP, R5F103A7DSP		

Note For fields of application, see **Figure 1-1 Part Number, Memory Size, and Package of RL78/G12**.

Caution The ordering part numbers represent the numbers at the time of publication. For the latest ordering part numbers, refer to the target product page of the Renesas Electronics website.

1.3 Differences between the R5F102 Products and the R5F103 Products

The following are differences between the R5F102 products and the R5F103 products.

- O Whether the data flash memory is mounted or not
- O High-speed on-chip oscillator oscillation frequency accuracy
- O Number of channels in serial interface
- O Whether the DMA function is mounted or not
- O Whether a part of the safety functions are mounted or not

1.3.1 Data Flash

The data flash memory of 2 KB is mounted on the R5F102 products, but not on the R5F103 products.

Product	Data Flash
<u>R5F102 products</u> R5F1026A, R5F1027A, R5F102AA, R5F10269, R5F10279, R5F102A9, R5F10268, R5F10278, R5F102A8, R5F10267, R5F10277, R5F102A7, R5F10266 <small>Note</small>	2 KB
<u>R5F103 products</u> R5F1036A, R5F1037A, R5F103AA, R5F10369, R5F10379, R5F103A9, R5F10368, R5F10378 R5F103A8, R5F10367, R5F10377, R5F103A7, R5F10366	Not mounted

Note The RAM in the R5F10266 has capacity as small as 256 bytes. Depending on the customer's program specification, the stack area to execute the data flash library may not be kept and data may not be written to or erased from the data flash memory.

Caution When the flash memory is rewritten via a user program, the code flash area and RAM area are used because each library is used. When using the library, refer to RL78 Family Flash Self Programming Library Type01 User's Manual and RL78 Family Data Flash Library Type04 User's Manual.

1.3.2 On-chip oscillator characteristics

(1) High-speed on-chip oscillator oscillation frequency of the R5F102 products

Oscillator	Condition	MIN	MAX	Unit
High-speed on-chip oscillator oscillation frequency accuracy	$T_A = -20$ to $+85^\circ\text{C}$	-1.0	+1.0	%
	$T_A = -40$ to -20°C	-1.5	+1.5	
	$T_A = +85$ to $+105^\circ\text{C}$	-2.0	+2.0	

(2) High-speed on-chip oscillator oscillation frequency of the R5F103 products

Oscillator	Condition	MIN	MAX	Unit
High-speed on-chip oscillator oscillation frequency accuracy	$T_A = -40$ to $+85^\circ\text{C}$	-5.0	+5.0	%

1.3.3 Peripheral Functions

The following are differences in peripheral functions between the R5F102 products and the R5F103 products.

RL78/G12		R5F102 product		R5F103 product	
		20, 24 pin product	30 pin product	20, 24 pin product	30 pin product
Serial interface	UART	1 channel	3 channels	1 channel	
	Simplified SPI (CSI)	2 channels	3 channels	1 channel	
	Simplified I ² C	2 channels	3 channels	None	
DMA function		2 channels		None	
Safety function	CRC operation	Yes		None	
	RAM guard	Yes		None	
	SFR guard	Yes		None	

1.4 Pin Configuration (Top View)

1.4.1 20-pin products

- 20-pin plastic LSSOP (4.4 × 6.5 mm, 0.65-mm pitch)
- 20-pin plastic TSSOP (4.4 × 6.5 mm, 0.65-mm pitch)



Note Provided only in the R5F102 products.

Remarks 1. For pin identification, see **1.5 Pin Identification**.

2. Functions in parentheses in the above figure can be assigned via settings in the peripheral I/O redirection register (PIOR). See **Figure 4-8 Format of Peripheral I/O Redirection Register (PIOR)** in the RL78/G12 User's Manual.

1.4.2 24-pin products

- 24-pin plastic HWQFN (4 × 4 mm, 0.5-mm pitch)

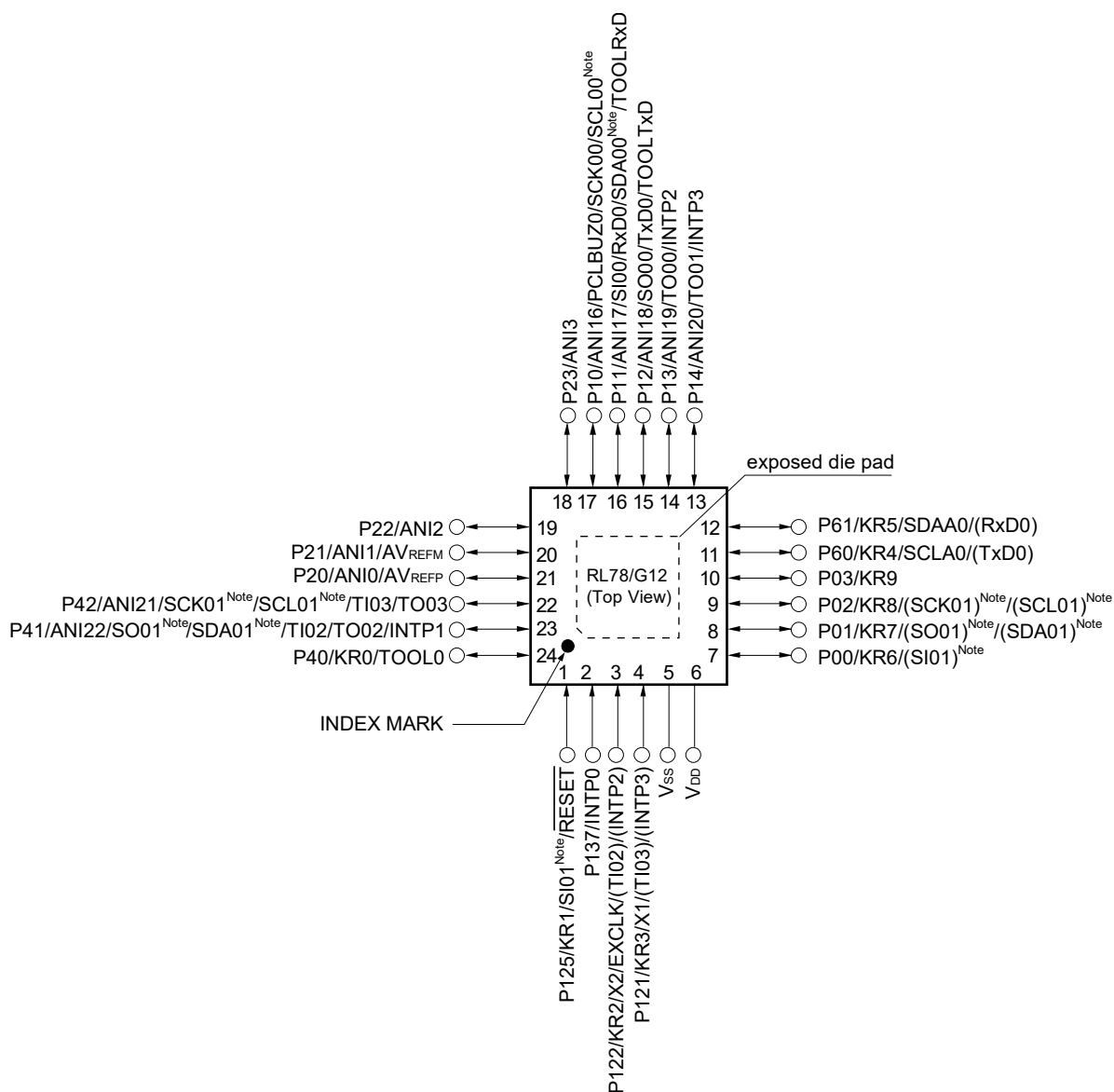

Note Provided only in the R5F102 products.

Remarks 1. For pin identification, see 1.5 Pin Identification.

2. Functions in parentheses in the above figure can be assigned via settings in the peripheral I/O redirection register (PIOR). See Figure 4-8 Format of Peripheral I/O Redirection Register (PIOR) in the RL78/G12 User's Manual.

3. It is recommended to connect an exposed die pad to V_{SS}.

1.4.3 30-pin products

- 30-pin plastic LSSOP (7.62 mm (300), 0.65-mm pitch)

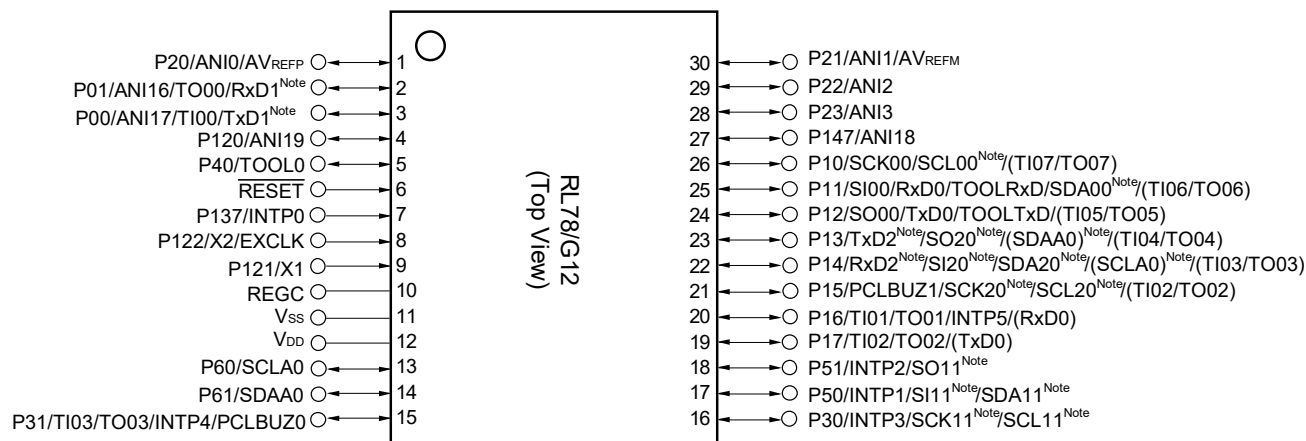

Note Provided only in the R5F102 products.

Caution Connect the REGC pin to V_{SS} via capacitor (0.47 to 1 μ F).

Remarks 1. For pin identification, see 1.5 Pin Identification.

2. Functions in parentheses in the above figure can be assigned via settings in the peripheral I/O redirection register (PIOR). See **Figure 4-8 Format of Peripheral I/O Redirection Register (PIOR)** in the RL78/G12 User's Manual.

1.5 Pin Identification

ANI0 to ANI3, ANI16 to ANI22:	Analog input	REGC:	Regulator Capacitance
AVREFM:	Analog Reference Voltage Minus	RESET:	Reset
AVREFP:	Analog reference voltage plus	RxD0 to RxD2:	Receive Data
EXCLK:	External Clock Input (Main System Clock)	SCK00, SCK01, SCK11, SCK20:	Serial Clock Input/Output
INTP0 to INTP5	Interrupt Request From Peripheral	SCL00, SCL01, SCL11, SCL20, SCLA0:	Serial Clock Input/Output
KR0 to KR9:	Key Return	SDA00, SDA01, SDA11, SDA20, SDAA0:	Serial Data Input/Output
P00 to P03:	Port 0	SI00, SI01, SI11, SI20:	Serial Data Input
P10 to P17:	Port 1	SO00, SO01, SO11, SO20:	Serial Data Output
P20 to P23:	Port 2	TI00 to TI07:	Timer Input
P30 to P31:	Port 3	TO00 to TO07:	Timer Output
P40 to P42:	Port 4	TOOL0:	Data Input/Output for Tool
P50, P51:	Port 5	TOOLRxD, TOOLTxD:	Data Input/Output for External Device
P60, P61:	Port 6	TxD0 to TxD2:	Transmit Data
P120 to P122, P125:	Port 12	VDD:	Power supply
P137:	Port 13	VSS:	Ground
P147:	Port 14	X1, X2:	Crystal Oscillator (Main System Clock)
PCLBUZ0, PCLBUZ1:	Programmable Clock Output/ Buzzer Output		

1.6 Block Diagram

1.6.1 20-pin products



Note Provided only in the R5F102 products.

1.6.2 24-pin products



Note Provided only in the R5F102 products.

1.6.3 30-pin products

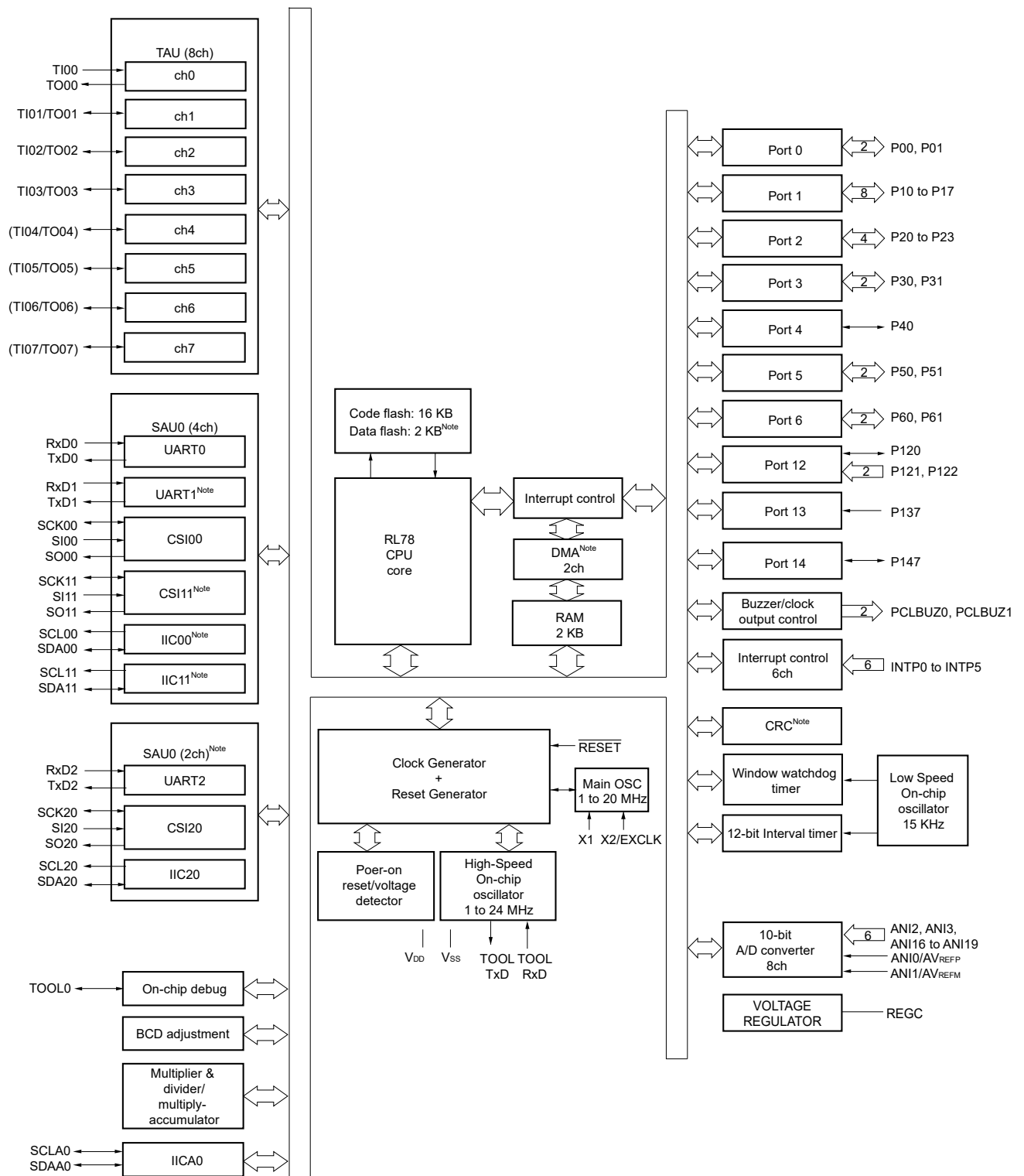

Note Provided only in the R5F102 products.

Remark Functions in parentheses in the above figure can be assigned via settings in the peripheral I/O redirection register (PIOR). See **Figure 4-8 Format of Peripheral I/O Redirection Register (PIOR)** in the RL78/G12 User's Manual.

1.7 Outline of Functions

This outline describes the function at the time when Peripheral I/O redirection register (PIOR) is set to 00H.

(1/2)

Item		20-pin		24-pin		30-pin	
		R5F1026x	R5F1036x	R5F1027x	R5F1037x	R5F102Ax	R5F103Ax
Code flash memory		2 to 16 KB ^{Note 1}		4 to 16 KB			
Data flash memory		2 KB	–	2 KB	–	2 KB	–
RAM		256 B to 1.5 KB		512 B to 1.5 KB		512 B to 2KB	
Address space		1 MB					
Main system clock	High-speed system clock	X1 (crystal/ceramic) oscillation, external main system clock input (EXCLK) HS (High-speed main) mode : 1 to 20 MHz ($V_{DD} = 2.7$ to 5.5 V), HS (High-speed main) mode : 1 to 16 MHz ($V_{DD} = 2.4$ to 5.5 V), LS (Low-speed main) mode : 1 to 8 MHz ($V_{DD} = 1.8$ to 5.5 V)					
	High-speed on-chip oscillator clock	HS (High-speed main) mode : 1 to 24 MHz ($V_{DD} = 2.7$ to 5.5 V), HS (High-speed main) mode : 1 to 16 MHz ($V_{DD} = 2.4$ to 5.5 V), LS (Low-speed main) mode : 1 to 8 MHz ($V_{DD} = 1.8$ to 5.5 V)					
Low-speed on-chip oscillator clock		15 kHz (TYP)					
General-purpose register		(8-bit register × 8) × 4 banks					
Minimum instruction execution time		0.04167 μs (High-speed on-chip oscillator clock: $f_{IH} = 24$ MHz operation)					
		0.05 μs (High-speed system clock: $f_{MX} = 20$ MHz operation)					
Instruction set		<ul style="list-style-type: none"> • Data transfer (8/16 bits) • Adder and subtractor/logical operation (8/16 bits) • Multiplication (8 bits × 8 bits) • Rotate, barrel shift, and bit manipulation (set, reset, test, and Boolean operation), etc. 					
I/O port	Total	18		22		26	
	CMOS I/O	12 (N-ch O.D. I/O [V_{DD} withstand voltage]: 4)		16 (N-ch O.D. I/O [V_{DD} withstand voltage]: 5)		21 (N-ch O.D. I/O [V_{DD} withstand voltage]: 9)	
	CMOS input	4		4		3	
	N-ch open-drain I/O (6 V tolerance)	2					
Timer	16-bit timer	4 channels				8 channels	
	Watchdog timer	1 channel					
	12-bit Interval timer	1 channel					
	Timer output	4 channels (PWM outputs: 3 ^{Note 3})				8 channels (PWM outputs: 7 ^{Notes 2, 3})	

- Notes**
1. The self-programming function cannot be used in the R5F10266 and R5F10366.
 2. The maximum number of channels when PIOR0 is set to 1.
 3. The number of PWM outputs varies depending on the setting of channels in use (the number of masters and slaves). (See **6.9.3 Operation as multiple PWM output function** in the RL78/G12 User's Manual.)

Caution When the flash memory is rewritten via a user program, the code flash area and RAM area are used because each library is used. When using the library, refer to RL78 Family Flash Self Programming Library Type01 User's Manual and RL78 Family Data Flash Library Type04 User's Manual.

(2/2)

Item	20-pin		24-pin		30-pin			
	R5F1026x	R5F1036x	R5F1027x	R5F1037x	R5F102Ax	R5F103Ax		
Clock output/buzzer output	1				2			
	2.44 kHz to 10 MHz: (Peripheral hardware clock: $f_{MAIN} = 20$ MHz operation)							
8/10-bit resolution A/D converter	11 channels				8 channels			
Serial interface	[R5F1026x (20-pin), R5F1027x (24-pin)]							
	<ul style="list-style-type: none"> • Simplified SPI (CSI): 2 channels/Simplified I²C: 2 channels/UART: 1 channel 							
	[R5F102Ax (30-pin)]							
I ² C bus	<ul style="list-style-type: none"> • Simplified SPI (CSI): 1 channel/Simplified I²C: 1 channel/UART: 1 channel • Simplified SPI (CSI): 1 channel/Simplified I²C: 1 channel/UART: 1 channel • Simplified SPI (CSI): 1 channel/Simplified I²C: 1 channel/UART: 1 channel 							
	[R5F1036x (20-pin), R5F1037x (24-pin)]							
	[R5F103Ax (30-pin)]							
Multiplier and divider/multiply-accumulator	<ul style="list-style-type: none"> • Simplified SPI (CSI): 1 channel/Simplified I²C: 0 channel/UART: 1 channel • Simplified SPI (CSI): 1 channel/Simplified I²C: 0 channel/UART: 1 channel 							
	1 channel							
DMA controller	<ul style="list-style-type: none"> • 16 bits × 16 bits = 32 bits (unsigned or signed) • 32 bits × 32 bits = 32 bits (unsigned) • 16 bits × 16 bits + 32 bits = 32 bits (unsigned or signed) 							
	2 channels		–		2 channels		–	
Vectored interrupt sources	Internal	18	16	18	16	26	19	
	External	5				6		
Key interrupt	6		10		–			
Reset	<ul style="list-style-type: none"> • Reset by \overline{RESET} pin • Internal reset by watchdog timer • Internal reset by power-on-reset • Internal reset by voltage detector • Internal reset by illegal instruction execution ^{Note} • Internal reset by RAM parity error • Internal reset by illegal-memory access 							
Power-on-reset circuit	<ul style="list-style-type: none"> • Power-on-reset: 1.51 V (TYP) • Power-down-reset: 1.50 V (TYP) 							
Voltage detector	<ul style="list-style-type: none"> • Rising edge : 1.88 to 4.06 V (12 stages) • Falling edge : 1.84 to 3.98 V (12 stages) 							
On-chip debug function	Provided							
Power supply voltage	$V_{DD} = 1.8$ to 5.5 V							
Operating ambient temperature	$T_A = -40$ to $+85^\circ\text{C}$ (A: Consumer applications, D: Industrial applications), $T_A = -40$ to $+105^\circ\text{C}$ (G: Industrial applications)							

Note The illegal instruction is generated when instruction code FFH is executed.

Reset by the illegal instruction execution not issued by emulation with the in-circuit emulator or on-chip debug emulator.

2. ELECTRICAL SPECIFICATIONS ($T_A = -40$ to $+85^\circ\text{C}$)

This chapter describes the following electrical specifications.

Target products A: Consumer applications $T_A = -40$ to $+85^\circ\text{C}$

R5F102xxAxx, R5F103xxAxx

D: Industrial applications $T_A = -40$ to $+85^\circ\text{C}$

R5F102xxDxx, R5F103xxDxx

G: Industrial applications when $T_A = -40$ to $+105^\circ\text{C}$ products is used in the range of $T_A = -40$ to $+85^\circ\text{C}$

R5F102xxGxx

- Cautions**
- 1. The RL78 microcontrollers have an on-chip debug function, which is provided for development and evaluation. Do not use the on-chip debug function in products designated for mass production, because the guaranteed number of rewritable times of the flash memory may be exceeded when this function is used, and product reliability therefore cannot be guaranteed. Renesas Electronics is not liable for problems occurring when the on-chip debug function is used.**
 - 2. The pins mounted depend on the product. Refer to 2.1 Port Functions to 2.2.1 Functions for each product in the RL78/G12 User's Manual.**

2.1 Absolute Maximum Ratings

Absolute Maximum Ratings ($T_A = 25^\circ\text{C}$)

Parameter	Symbols	Conditions		Ratings	Unit
Supply Voltage	V_{DD}			-0.5 to + 6.5	V
REGC terminal input voltage ^{Note 1}	V_{IREGC}	REGC		-0.3 to +2 and -0.3 to $V_{DD} + 0.3$ ^{Note 2}	V
Input Voltage	V_{I1}	Other than P60, P61		-0.3 to $V_{DD} + 0.3$ ^{Note 3}	V
	V_{I2}	P60, P61 (N-ch open drain)		-0.3 to 6.5	V
Output Voltage	V_O			-0.3 to $V_{DD} + 0.3$ ^{Note 3}	V
Analog input voltage	V_{AI}	20-, 24-pin products: ANI0 to ANI3, ANI16 to ANI22 30-pin products: ANI0 to ANI3, ANI16 to ANI19		-0.3 to $V_{DD} + 0.3$ and -0.3 to $AV_{REF}(+) + 0.3$ ^{Notes 3, 4}	V
Output current, high	I_{OH1}	Per pin	Other than P20 to P23	-40	mA
		Total of all pins	All the terminals other than P20 to P23	-170	mA
			20-, 24-pin products: P40 to P42 30-pin products: P00, P01, P40, P120	-70	mA
			20-, 24-pin products: P00 to P03 ^{Note 5} , P10 to P14 30-pin products: P10 to P17, P30, P31, P50, P51, P147	-100	mA
	I_{OH2}	Per pin	P20 to P23	-0.5	mA
		Total of all pins		-2	mA
Output current, low	I_{OL1}	Per pin	Other than P20 to P23	40	mA
		Total of all pins	All the terminals other than P20 to P23	170	mA
			20-, 24-pin products: P40 to P42 30-pin products: P00, P01, P40, P120	70	mA
			20-, 24-pin products: P00 to P03 ^{Note 5} , P10 to P14, P60, P61 30-pin products: P10 to P17, P30, P31, P50, P51, P60, P61, P147	100	mA
	I_{OL2}	Per pin	P20 to P23	1	mA
		Total of all pins		5	mA
Operating ambient temperature	T_A			-40 to +85	$^\circ\text{C}$
Storage temperature	T_{stg}			-65 to +150	$^\circ\text{C}$

Notes 1. 30-pin product only.

2. Connect the REGC pin to V_{SS} via a capacitor (0.47 to 1 μF). This value determines the absolute maximum rating of the REGC pin. Do not use it with voltage applied.

3. Must be 6.5 V or lower.

4. Do not exceed $AV_{REF}(+) + 0.3$ V in case of A/D conversion target pin.

5. 24-pin products only.

Caution Product quality may suffer if the absolute maximum rating is exceeded even momentarily for any parameter. That is, the absolute maximum ratings are rated values at which the product is on the verge of suffering physical damage, and therefore the product must be used under conditions that ensure that the absolute maximum ratings are not exceeded.

Remarks 1. Unless specified otherwise, the characteristics of alternate-function pins are the same as those of the port pins.

2. $AV_{REF}(+)$: + side reference voltage of the A/D converter.

3. V_{SS} : Reference voltage

2.2 Oscillator Characteristics

2.2.1 X1 oscillator characteristics

($T_A = -40$ to $+85^\circ\text{C}$, $1.8\text{ V} \leq V_{DD} \leq 5.5\text{ V}$, $V_{SS} = 0\text{ V}$)

Parameter	Resonator	Conditions	MIN.	TYP.	MAX.	Unit
X1 clock oscillation frequency (f_x) ^{Note}	Ceramic resonator / crystal oscillator	$2.7\text{ V} \leq V_{DD} \leq 5.5\text{ V}$	1.0		20.0	MHz
		$1.8\text{ V} \leq V_{DD} < 2.7\text{ V}$	1.0		8.0	

Note Indicates only permissible oscillator frequency ranges. Refer to AC Characteristics for instruction execution time. Request evaluation by the manufacturer of the oscillator circuit mounted on a board to check the oscillator characteristics.

Caution Since the CPU is started by the high-speed on-chip oscillator clock after a reset release, check the X1 clock oscillation stabilization time using the oscillation stabilization time counter status register (OSTC) by the user. Determine the oscillation stabilization time of the OSTC register and the oscillation stabilization time select register (OSTS) after sufficiently evaluating the oscillation stabilization time with the resonator to be used.

Remark When using the X1 oscillator, refer to **5.4 System Clock Oscillator** in the RL78/G12 User's Manual.

2.2.2 On-chip oscillator characteristics

($T_A = -40$ to $+85^\circ\text{C}$, $1.8\text{ V} \leq V_{DD} \leq 5.5\text{ V}$, $V_{SS} = 0\text{ V}$)

Oscillators	Parameters	Conditions		MIN.	TYP.	MAX.	Unit
High-speed on-chip oscillator clock frequency ^{Notes 1, 2}	f_{iH}			1		24	MHz
High-speed on-chip oscillator clock frequency accuracy		R5F102 products	$T_A = -20$ to $+85^\circ\text{C}$	-1.0		+1.0	%
			$T_A = -40$ to -20°C	-1.5		+1.5	%
		R5F103 products		-5.0		+5.0	%
Low-speed on-chip oscillator clock frequency	f_{iL}				15		kHz
Low-speed on-chip oscillator clock frequency accuracy				-15		+15	%

Notes 1. High-speed on-chip oscillator frequency is selected by bits 0 to 3 of option byte (000C2H) and bits 0 to 2 of HOCODIV register.

2. This only indicates the oscillator characteristics. Refer to AC Characteristics for instruction execution time.

2.3 DC Characteristics

2.3.1 Pin characteristics

(T_A = -40 to +85°C, 1.8 V ≤ V_{DD} ≤ 5.5 V, V_{SS} = 0 V)

(1/4)

Parameter	Symbol	Conditions	MIN.	TYP.	MAX.	Unit		
Output current, high ^{Note 1}	I _{OH1}	20-, 24-pin products: Per pin for P00 to P03 ^{Note 4} , P10 to P14, P40 to P42 30-pin products: Per pin for P00, P01, P10 to P17, P30, P31, P40, P50, P51, P120, P147			-10.0 ^{Note 2}	mA		
		20-, 24-pin products: Total of P40 to P42 30-pin products: Total of P00, P01, P40, P120 (When duty ≤ 70% ^{Note 3})	4.0 V ≤ V _{DD} ≤ 5.5 V			-30.0	mA	
			2.7 V ≤ V _{DD} < 4.0 V			-6.0	mA	
			1.8 V ≤ V _{DD} < 2.7 V			-4.5	mA	
		20-, 24-pin products: Total of P00 to P03 ^{Note 4} , P10 to P14 30-pin products: Total of P10 to P17, P30, P31, P50, P51, P147 (When duty ≤ 70% ^{Note 3})	4.0 V ≤ V _{DD} ≤ 5.5 V			-80.0	mA	
			2.7 V ≤ V _{DD} < 4.0 V			-18.0	mA	
			1.8 V ≤ V _{DD} < 2.7 V			-10.0	mA	
		Total of all pins (When duty ≤ 70% ^{Note 3})				-100	mA	
		I _{OH2}	Per pin for P20 to P23				-0.1	mA
			Total of all pins				-0.4	mA

- Notes**
- value of current at which the device operation is guaranteed even if the current flows from the V_{DD} pin to an output pin.
 - However, do not exceed the total current value.
 - The output current value under conditions where the duty factor ≤ 70%.
If duty factor > 70%: The output current value can be calculated with the following expression (where n represents the duty factor as a percentage).
 - Total output current of pins = (I_{OH} × 0.7)/(n × 0.01)
<Example> Where n = 80% and I_{OH} = -10.0 mA
Total output current of pins = (-10.0 × 0.7)/(80 × 0.01) ≅ -8.7 mA
 However, the current that is allowed to flow into one pin does not vary depending on the duty factor. A current higher than the absolute maximum rating must not flow into one pin.
 - 24-pin products only.

Caution P10 to P12 and P41 for 20-pin products, P01, P10 to P12, and P41 for 24-pin products, and P00, P10 to P15, P17, and P50 for 30-pin products do not output high level in N-ch open-drain mode.

Remark Unless specified otherwise, the characteristics of alternate-function pins are the same as those of the port pins.

(T_A = -40 to +85°C, 1.8 V ≤ V_{DD} ≤ 5.5 V, V_{SS} = 0 V)

(2/4)

Parameter	Symbol	Conditions	MIN.	TYP.	MAX.	Unit	
Output current, low ^{Note 1}	I _{OL1}	20-, 24-pin products: Per pin for P00 to P03 ^{Note 4} , P10 to P14, P40 to P42 30-pin products: Per pin for P00, P01, P10 to P17, P30, P31, P40, P50, P51, P120, P147			20.0 ^{Note 2}	mA	
		Per pin for P60, P61			15.0 ^{Note 2}	mA	
		20-, 24-pin products: Total of P40 to P42 30-pin products: Total of P00, P01, P40, P120 (When duty ≤ 70% ^{Note 3})	4.0 V ≤ V _{DD} ≤ 5.5 V			60.0	mA
			2.7 V ≤ V _{DD} < 4.0 V			9.0	mA
			1.8 V ≤ V _{DD} < 2.7 V			1.8	mA
		20-, 24-pin products: Total of P00 to P03 ^{Note 4} , P10 to P14, P60, P61 30-pin products: Total of P10 to P17, P30, P31, P50, P51, P60, P61, P147 (When duty ≤ 70% ^{Note 3})	4.0 V ≤ V _{DD} ≤ 5.5 V			80.0	mA
			2.7 V ≤ V _{DD} < 4.0 V			27.0	mA
			1.8 V ≤ V _{DD} < 2.7 V			5.4	mA
		Total of all pins (When duty ≤ 70% ^{Note 3})				140	mA
		I _{OL2}	Per pin for P20 to P23				0.4
Total of all pins					1.6	mA	

- Notes**
- Value of current at which the device operation is guaranteed even if the current flows from an output pin to the V_{SS} pin.
 - However, do not exceed the total current value.
 - The output current value under conditions where the duty factor ≤ 70%.
If duty factor > 70%: The output current value can be calculated with the following expression (where n represents the duty factor as a percentage).
 - Total output current of pins = (I_{OL} × 0.7)/(n × 0.01)
 <Example> Where n = 80% and I_{OL} = 10.0 mA
 Total output current of pins = (10.0 × 0.7)/(80 × 0.01) ≅ 8.7 mA
 However, the current that is allowed to flow into one pin does not vary depending on the duty factor. A current higher than the absolute maximum rating must not flow into one pin.
 - 24-pin products only.

Remark Unless specified otherwise, the characteristics of alternate-function pins are the same as those of the port pins.

$(T_A = -40$ to $+85^\circ\text{C}$, $1.8\text{ V} \leq V_{DD} \leq 5.5\text{ V}$, $V_{SS} = 0\text{ V}$)

(3/4)

Parameter	Symbol	Conditions	MIN.	TYP.	MAX.	Unit
Input voltage, high	V_{IH1}	Normal input buffer 20-, 24-pin products: P00 to P03 ^{Note 2} , P10 to P14, P40 to P42 30-pin products: P00, P01, P10 to P17, P30, P31, P40, P50, P51, P120, P147	$0.8V_{DD}$		V_{DD}	V
	V_{IH2}	TTL input buffer 20-, 24-pin products: P10, P11 30-pin products: P01, P10, P11, P13 to P17	$4.0\text{ V} \leq V_{DD} \leq 5.5\text{ V}$	2.2	V_{DD}	V
			$3.3\text{ V} \leq V_{DD} < 4.0\text{ V}$	2.0	V_{DD}	V
			$1.8\text{ V} \leq V_{DD} < 3.3\text{ V}$	1.5	V_{DD}	V
	V_{IH3}	P20 to P23	$0.7V_{DD}$		V_{DD}	V
	V_{IH4}	P60, P61	$0.7V_{DD}$		6.0	V
V_{IH5}	P121, P122, P125 ^{Note 1} , P137, EXCLK, RESET	$0.8V_{DD}$		V_{DD}	V	
Input voltage, low	V_{IL1}	Normal input buffer 20-, 24-pin products: P00 to P03 ^{Note 2} , P10 to P14, P40 to P42 30-pin products: P00, P01, P10 to P17, P30, P31, P40, P50, P51, P120, P147	0		$0.2V_{DD}$	V
	V_{IL2}	TTL input buffer 20-, 24-pin products: P10, P11 30-pin products: P01, P10, P11, P13 to P17	$4.0\text{ V} \leq V_{DD} \leq 5.5\text{ V}$	0	0.8	V
			$3.3\text{ V} \leq V_{DD} < 4.0\text{ V}$	0	0.5	V
			$1.8\text{ V} \leq V_{DD} < 3.3\text{ V}$	0	0.32	V
	V_{IL3}	P20 to P23	0		$0.3V_{DD}$	V
	V_{IL4}	P60, P61	0		$0.3V_{DD}$	V
V_{IL5}	P121, P122, P125 ^{Note 1} , P137, EXCLK, RESET	0		$0.2V_{DD}$	V	
Output voltage, high	V_{OH1}	20-, 24-pin products: P00 to P03 ^{Note 2} , P10 to P14, P40 to P42 30-pin products: P00, P01, P10 to P17, P30, P31, P40, P50, P51, P120, P147	$4.0\text{ V} \leq V_{DD} \leq 5.5\text{ V}$, $I_{OH1} = -10.0\text{ mA}$	$V_{DD}-1.5$		V
			$4.0\text{ V} \leq V_{DD} \leq 5.5\text{ V}$, $I_{OH1} = -3.0\text{ mA}$	$V_{DD}-0.7$		V
			$2.7\text{ V} \leq V_{DD} \leq 5.5\text{ V}$, $I_{OH1} = -2.0\text{ mA}$	$V_{DD}-0.6$		V
			$1.8\text{ V} \leq V_{DD} \leq 5.5\text{ V}$, $I_{OH1} = -1.5\text{ mA}$	$V_{DD}-0.5$		V
	V_{OH2}	P20 to P23	$I_{OH2} = -100\text{ }\mu\text{A}$	$V_{DD}-0.5$		V

Notes 1. 20, 24-pin products only.

2. 24-pin products only.

Caution The maximum value of V_{IH} of pins P10 to P12 and P41 for 20-pin products, P01, P10 to P12, and P41 for 24-pin products, and P00, P10 to P15, P17, and P50 for 30-pin products is V_{DD} even in N-ch open-drain mode.

High level is not output in the N-ch open-drain mode.

Remark Unless specified otherwise, the characteristics of alternate-function pins are the same as those of the port pins.

$(T_A = -40$ to $+85^\circ\text{C}$, $1.8\text{ V} \leq V_{DD} \leq 5.5\text{ V}$, $V_{SS} = 0\text{ V}$)

(4/4)

Parameter	Symbol	Conditions		MIN.	TYP.	MAX.	Unit
Output voltage, low	V_{OL1}	20-, 24-pin products: P00 to P03 ^{Note} , P10 to P14, P40 to P42 30-pin products: P00, P01, P10 to P17, P30, P31, P40, P50, P51, P120, P147	$4.0\text{ V} \leq V_{DD} \leq 5.5\text{ V}$, $I_{OL1} = 20.0\text{ mA}$			1.3	V
			$4.0\text{ V} \leq V_{DD} \leq 5.5\text{ V}$, $I_{OL1} = 8.5\text{ mA}$			0.7	V
			$2.7\text{ V} \leq V_{DD} \leq 5.5\text{ V}$, $I_{OL1} = 3.0\text{ mA}$			0.6	V
			$2.7\text{ V} \leq V_{DD} \leq 5.5\text{ V}$, $I_{OL1} = 1.5\text{ mA}$			0.4	V
			$1.8\text{ V} \leq V_{DD} \leq 5.5\text{ V}$, $I_{OL1} = 0.6\text{ mA}$			0.4	V
	V_{OL2}	P20 to P23	$I_{OL2} = 400\text{ }\mu\text{A}$			0.4	V
	V_{OL3}	P60, P61	$4.0\text{ V} \leq V_{DD} \leq 5.5\text{ V}$, $I_{OL1} = 15.0\text{ mA}$			2.0	V
			$4.0\text{ V} \leq V_{DD} \leq 5.5\text{ V}$, $I_{OL1} = 5.0\text{ mA}$			0.4	V
			$2.7\text{ V} \leq V_{DD} \leq 5.5\text{ V}$, $I_{OL1} = 3.0\text{ mA}$			0.4	V
			$1.8\text{ V} \leq V_{DD} \leq 5.5\text{ V}$, $I_{OL1} = 2.0\text{ mA}$			0.4	V
Input leakage current, high	I_{LIH1}	Other than P121, P122	$V_i = V_{DD}$			1	μA
	I_{LIH2}	P121, P122 (X1, X2/EXCLK)	$V_i = V_{DD}$	Input port or external clock input		1	μA
				When resonator connected		10	μA
Input leakage current, low	I_{LIL1}	Other than P121, P122	$V_i = V_{SS}$			-1	μA
	I_{LIL2}	P121, P122 (X1, X2/EXCLK)	$V_i = V_{SS}$	Input port or external clock input		-1	μA
				When resonator connected		-10	μA
On-chip pull-up resistance	R_U	20-, 24-pin products: P00 to P03 ^{Note} , P10 to P14, P40 to P42, P125, RESET 30-pin products: P00, P01, P10 to P17, P30, P31, P40, P50, P51, P120, P147	$V_i = V_{SS}$, input port	10	20	100	k Ω

Note 24-pin products only.**Remark** Unless specified otherwise, the characteristics of alternate-function pins are the same as those of the port pins.

2.3.2 Supply current characteristics

(1) 20-, 24-pin products

(T_A = -40 to +85°C, 1.8 V ≤ V_{DD} ≤ 5.5 V, V_{SS} = 0 V)

(1/2)

Parameter	Symbol	Conditions				MIN.	TYP.	MAX.	Unit		
Supply current ^{Note 1}	IDD1	Operating mode	HS(High-speed main) mode ^{Note 4}	f _{IH} = 24 MHz ^{Note 3}	Basic operation	V _{DD} = 5.0 V		1.5		mA	
						V _{DD} = 3.0 V		1.5			
					Normal operation	V _{DD} = 5.0 V		3.3	5.0	mA	
						V _{DD} = 3.0 V		3.3	5.0		
				f _{IH} = 16 MHz ^{Note 3}	V _{DD} = 5.0 V		2.5	3.7	mA		
					V _{DD} = 3.0 V		2.5	3.7			
					LS(Low-speed main) mode ^{Note 4}	f _{IH} = 8 MHz ^{Note 3}	V _{DD} = 3.0 V		1.2	1.8	mA
						V _{DD} = 2.0 V		1.2	1.8		
			HS(High-speed main) mode ^{Note 4}	f _{MX} = 20 MHz ^{Note 2} , V _{DD} = 5.0 V	Square wave input		2.8	4.4	mA		
						Resonator connection		3.0		4.6	
					Square wave input		2.8	4.4	mA		
						Resonator connection		3.0		4.6	
				f _{MX} = 20 MHz ^{Note 2} , V _{DD} = 3.0 V	Square wave input		1.8	2.6	mA		
						Resonator connection		1.8		2.6	
					Square wave input		1.8	2.6	mA		
						Resonator connection		1.8		2.6	
f _{MX} = 10 MHz ^{Note 2} , V _{DD} = 5.0 V	Square wave input		1.1	1.7	mA						
		Resonator connection		1.1		1.7					
	Square wave input		1.1	1.7	mA						
		Resonator connection		1.1		1.7					
LS(Low-speed main) mode ^{Note 4}	f _{MX} = 8 MHz ^{Note 2} , V _{DD} = 3.0 V	Square wave input		1.1	1.7	mA					
			Resonator connection		1.1		1.7				
	f _{MX} = 8 MHz ^{Note 2} , V _{DD} = 2.0 V	Square wave input		1.1	1.7	mA					
			Resonator connection		1.1		1.7				

- Notes**
- Total current flowing into V_{DD}, including the input leakage current flowing when the level of the input pin is fixed to V_{DD} or V_{SS}. The values below the MAX. column include the peripheral operation current. However, not including the current flowing into the A/D converter, LVD circuit, I/O port, and on-chip pull-up/pull-down resistors and the current flowing during data flash rewrite.
 - When high-speed on-chip oscillator clock is stopped.
 - When high-speed system clock is stopped
 - Relationship between operation voltage width, operation frequency of CPU and operation mode is as follows.
 HS (High speed main) mode: V_{DD} = 2.7 V to 5.5 V @1 MHz to 24 MHz
 V_{DD} = 2.4 V to 5.5 V @1 MHz to 16 MHz
 LS (Low speed main) mode: V_{DD} = 1.8 V to 5.5 V @1 MHz to 8 MHz

- Remarks**
- f_{MX}: High-speed system clock frequency (X1 clock oscillation frequency or external main system clock frequency)
 - f_{IH}: high-speed on-chip oscillator clock frequency
 - Temperature condition of the TYP. value is T_A = 25°C.

(1) 20-, 24-pin products

 $(T_A = -40$ to $+85^\circ\text{C}$, $1.8\text{ V} \leq V_{DD} \leq 5.5\text{ V}$, $V_{SS} = 0\text{ V}$)

(2/2)

Parameter	Symbol	Conditions			MIN.	TYP.	MAX.	Unit		
Supply current ^{Note 1}	I _{DD2} ^{Note 2}	HALT mode	HS (High-speed main) mode ^{Note 6}	f _{IH} = 24 MHz ^{Note 4}	V _{DD} = 5.0 V		440	1210	μA	
					V _{DD} = 3.0 V		440	1210		
				f _{IH} = 16 MHz ^{Note 4}	V _{DD} = 5.0 V		400	950	μA	
					V _{DD} = 3.0 V		400	950		
				LS (Low-speed main) mode ^{Note 6}	f _{IH} = 8 MHz ^{Note 4}	V _{DD} = 3.0 V		270	542	μA
						V _{DD} = 2.0 V		270	542	
			HS (High-speed main) mode ^{Note 6}	f _{MX} = 20 MHz ^{Note 3} , V _{DD} = 5.0 V	Square wave input		280	1000	μA	
					Resonator connection		450	1170		
				f _{MX} = 20 MHz ^{Note 3} , V _{DD} = 3.0 V	Square wave input		280	1000	μA	
					Resonator connection		450	1170		
				f _{MX} = 10 MHz ^{Note 3} , V _{DD} = 5.0 V	Square wave input		190	590	μA	
					Resonator connection		260	660		
				f _{MX} = 10 MHz ^{Note 3} , V _{DD} = 3.0 V	Square wave input		190	590	μA	
					Resonator connection		260	660		
			LS (Low-speed main) mode ^{Note 6}	f _{MX} = 8 MHz ^{Note 3} , V _{DD} = 3.0 V	Square wave input		110	360	μA	
Resonator connection		150			416					
f _{MX} = 8 MHz ^{Note 3} , V _{DD} = 2.0 V	Square wave input			110	360	μA				
	Resonator connection			150	416					
I _{DD3} ^{Note 5}	STOP mode	T _A = -40°C				0.19	0.50	μA		
		T _A = +25°C				0.24	0.50			
		T _A = +50°C				0.32	0.80			
		T _A = +70°C				0.48	1.20			
		T _A = +85°C				0.74	2.20			

- Notes**
- Total current flowing into V_{DD}, including the input leakage current flowing when the level of the input pin is fixed to V_{DD} or V_{SS}. The values below the MAX. column include the peripheral operation current. However, not including the current flowing into the A/D converter, LVD circuit, I/O port, and on-chip pull-up/pull-down resistors and the current flowing during data flash rewrite.
 - During HALT instruction execution by flash memory.
 - When high-speed on-chip oscillator clock is stopped.
 - When high-speed system clock is stopped.
 - Not including the current flowing into the 12-bit interval timer and watchdog timer.
 - Relationship between operation voltage width, operation frequency of CPU and operation mode is as follows.
 HS (High speed main) mode: V_{DD} = 2.7 V to 5.5 V @1 MHz to 24 MHz
 V_{DD} = 2.4 V to 5.5 V @1 MHz to 16 MHz
 LS (Low speed main) mode: V_{DD} = 1.8 V to 5.5 V @1 MHz to 8 MHz

- Remarks**
- f_{MX}: High-speed system clock frequency (X1 clock oscillation frequency or external main system clock frequency)
 - f_{IH}: high-speed on-chip oscillator clock frequency
 - Except temperature condition of the TYP. value is T_A = 25°C, other than STOP mode

(2) 30-pin products

 $(T_A = -40$ to $+85^\circ\text{C}$, $1.8\text{ V} \leq V_{DD} \leq 5.5\text{ V}$, $V_{SS} = 0\text{ V})$

(1/2)

Parameter	Symbol	Conditions					MIN.	TYP.	MAX.	Unit	
Supply current ^{Note 1}	I _{DD1}	Operating mode	HS (High-speed main) mode ^{Note 4}	$f_{IH} = 24\text{ MHz}$ ^{Note 3}	Basic operation	$V_{DD} = 5.0\text{ V}$		1.5		mA	
						$V_{DD} = 3.0\text{ V}$		1.5			
					Normal operation	$V_{DD} = 5.0\text{ V}$		3.7	5.5	mA	
						$V_{DD} = 3.0\text{ V}$		3.7	5.5		
				$f_{IH} = 16\text{ MHz}$ ^{Note 3}	$V_{DD} = 5.0\text{ V}$		2.7	4.0	mA		
					$V_{DD} = 3.0\text{ V}$		2.7	4.0			
					LS (Low-speed main) mode ^{Note 4}	$f_{IH} = 8\text{ MHz}$ ^{Note 3}	$V_{DD} = 3.0\text{ V}$		1.2	1.8	mA
						$V_{DD} = 2.0\text{ V}$		1.2	1.8		
			HS (High-speed main) mode ^{Note 4}	$f_{MX} = 20\text{ MHz}$ ^{Note 2} , $V_{DD} = 5.0\text{ V}$	Square wave input		3.0	4.6	mA		
					Resonator connection		3.2	4.8			
					$f_{MX} = 20\text{ MHz}$ ^{Note 2} , $V_{DD} = 3.0\text{ V}$	Square wave input		3.0	4.6	mA	
						Resonator connection		3.2	4.8		
				$f_{MX} = 10\text{ MHz}$ ^{Note 2} , $V_{DD} = 5.0\text{ V}$	Square wave input		1.9	2.7	mA		
					Resonator connection		1.9	2.7			
				$f_{MX} = 10\text{ MHz}$ ^{Note 2} , $V_{DD} = 3.0\text{ V}$	Square wave input		1.9	2.7	mA		
					Resonator connection		1.9	2.7			
LS (Low-speed main) mode ^{Note 4}	$f_{MX} = 8\text{ MHz}$ ^{Note 2} , $V_{DD} = 3.0\text{ V}$	Square wave input		1.1	1.7	mA					
		Resonator connection		1.1	1.7						
	$f_{MX} = 8\text{ MHz}$ ^{Note 2} , $V_{DD} = 2.0\text{ V}$	Square wave input		1.1	1.7	mA					
		Resonator connection		1.1	1.7						

- Notes**
- Total current flowing into V_{DD} , including the input leakage current flowing when the level of the input pin is fixed to V_{DD} or V_{SS} . The values below the MAX. column include the peripheral operation current. However, not including the current flowing into the A/D converter, LVD circuit, I/O port, and on-chip pull-up/pull-down resistors and the current flowing during data flash rewrite.
 - When high-speed on-chip oscillator clock is stopped.
 - When high-speed system clock is stopped
 - Relationship between operation voltage width, operation frequency of CPU and operation mode is as follows.
 HS (High speed main) mode: $V_{DD} = 2.7\text{ V}$ to 5.5 V @1 MHz to 24 MHz
 $V_{DD} = 2.4\text{ V}$ to 5.5 V @1 MHz to 16 MHz
 LS (Low speed main) mode: $V_{DD} = 1.8\text{ V}$ to 5.5 V @1 MHz to 8 MHz

- Remarks**
- f_{MX} : High-speed system clock frequency (X1 clock oscillation frequency or external main system clock frequency)
 - f_{IH} : high-speed on-chip oscillator clock frequency
 - Temperature condition of the TYP. value is $T_A = 25^\circ\text{C}$.

(2) 30-pin products

 $(T_A = -40$ to $+85^\circ\text{C}$, $1.8\text{ V} \leq V_{DD} \leq 5.5\text{ V}$, $V_{SS} = 0\text{ V}$)

(2/2)

Parameter	Symbol	Conditions				MIN.	TYP.	MAX.	Unit	
Supply current ^{Note 1}	I _{DD2} ^{Note 2}	HALT mode	HS (High-speed main) mode ^{Note 6}	f _{IH} = 24 MHz ^{Note 4}	V _{DD} = 5.0 V		440	1280	μA	
					V _{DD} = 3.0 V		440	1280		
				f _{IH} = 16 MHz ^{Note 4}	V _{DD} = 5.0 V		400	1000	μA	
					V _{DD} = 3.0 V		400	1000		
				LS (Low-speed main) mode ^{Note 6}	f _{IH} = 8 MHz ^{Note 4}	V _{DD} = 3.0 V		260	530	μA
						V _{DD} = 2.0 V		260	530	
			HS (High-speed main) mode ^{Note 6}	f _{MX} = 20 MHz ^{Note 3} , V _{DD} = 5.0 V	Square wave input		280	1000	μA	
					Resonator connection		450	1170		
				f _{MX} = 20 MHz ^{Note 3} , V _{DD} = 3.0 V	Square wave input		280	1000	μA	
					Resonator connection		450	1170		
				f _{MX} = 10 MHz ^{Note 3} , V _{DD} = 5.0 V	Square wave input		190	600	μA	
					Resonator connection		260	670		
				f _{MX} = 10 MHz ^{Note 3} , V _{DD} = 3.0 V	Square wave input		190	600	μA	
					Resonator connection		260	670		
			LS (Low-speed main) mode ^{Note 6}	f _{MX} = 8 MHz ^{Note 3} , V _{DD} = 3.0 V	Square wave input		95	330	μA	
					Resonator connection		145	380		
f _{MX} = 8 MHz ^{Note 3} , V _{DD} = 2.0 V	Square wave input			95	330	μA				
	Resonator connection			145	380					
I _{DD3} ^{Note 5}	STOP mode	T _A = -40°C					0.18	0.50	μA	
		T _A = +25°C					0.23	0.50		
		T _A = +50°C					0.30	1.10		
		T _A = +70°C					0.46	1.90		
		T _A = +85°C					0.75	3.30		

Notes 1. Total current flowing into V_{DD}, including the input leakage current flowing when the level of the input pin is fixed to V_{DD} or V_{SS}. The values below the MAX. column include the peripheral operation current. However, not including the current flowing into the A/D converter, LVD circuit, I/O port, and on-chip pull-up/pull-down resistors and the current flowing during data flash rewrite.

2. During HALT instruction execution by flash memory.
3. When high-speed on-chip oscillator clock is stopped.
4. When high-speed system clock is stopped.
5. Not including the current flowing into the 12-bit interval timer and watchdog timer.
6. Relationship between operation voltage width, operation frequency of CPU and operation mode is as follows.

HS (High speed main) mode: V_{DD} = 2.7 V to 5.5 V @1 MHz to 24 MHz

V_{DD} = 2.4 V to 5.5 V @1 MHz to 16 MHz

LS (Low speed main) mode: V_{DD} = 1.8 V to 5.5 V @1 MHz to 8 MHz

Remarks 1. f_{MX}: High-speed system clock frequency (X1 clock oscillation frequency or external main system clock frequency)

2. f_{IH}: high-speed on-chip oscillator clock frequency
3. Except STOP mode, temperature condition of the TYP. value is T_A = 25°C.

(3) Peripheral functions (Common to all products)**($T_A = -40$ to $+85^\circ\text{C}$, $1.8\text{ V} \leq V_{DD} \leq 5.5\text{ V}$, $V_{SS} = 0\text{ V}$)**

Parameter	Symbol	Conditions		MIN.	TYP.	MAX.	Unit
Low-speed onchip oscillator operating current	I_{FIL} ^{Note 1}				0.20		μA
12-bit interval timer operating current	I_{TMKA} ^{Notes 1, 2, 3}				0.02		μA
Watchdog timer operating current	I_{WDT} ^{Notes 1, 2, 4}	$f_{IL} = 15\text{ kHz}$			0.22		μA
A/D converter operating current	I_{ADC} ^{Notes 1, 5}	When conversion at maximum speed	Normal mode, $AV_{REFP} = V_{DD} = 5.0\text{ V}$		1.30	1.70	mA
			Low voltage mode, $AV_{REFP} = V_{DD} = 3.0\text{ V}$		0.50	0.70	mA
A/D converter reference voltage operating current	I_{ADREF} ^{Note 1}				75.0		μA
Temperature sensor operating current	I_{TMPS} ^{Note 1}				75.0		μA
LVD operating current	I_{LVD} ^{Notes 1, 6}				0.08		μA
Self-programming operating current	I_{FSP} ^{Notes 1, 8}				2.00	12.20	mA
BGO operating current	I_{BGO} ^{Notes 1, 7}				2.00	12.20	mA
SNOOZE operating current	I_{SNOZ} ^{Note 1}	ADC operation	The mode is performed ^{Note 9}		0.50	0.60	mA
			The A/D conversion operations are performed, Low voltage mode, $AV_{REFP} = V_{DD} = 3.0\text{ V}$		1.20	1.44	mA
		Simplified SPI (CSI)/UART operation				0.70	0.84

- Notes**
1. Current flowing to the V_{DD} .
 2. When high speed on-chip oscillator and high-speed system clock are stopped.
 3. Current flowing only to the 12-bit interval timer (excluding the operating current of the low-speed on-chip oscillator). The current value of the RL78 microcontrollers is the sum of I_{DD1} , I_{DD2} or I_{DD3} , and I_{FIL} and I_{TMKA} when the 12-bit interval timer operates.
 4. Current flowing only to the watchdog timer (including the operating current of the low-speed on-chip oscillator). The current value of the RL78 microcontrollers is the sum of I_{DD1} , I_{DD2} or I_{DD3} and I_{WDT} when the watchdog timer operates.
 5. Current flowing only to the A/D converter. The current value of the RL78 microcontrollers is the sum of I_{DD1} or I_{DD2} and I_{ADC} when the A/D converter operates in an operation mode or the HALT mode.
 6. Current flowing only to the LVD circuit. The current value of the RL78 microcontrollers is the sum of I_{DD1} , I_{DD2} or I_{DD3} and I_{LVD} when the LVD circuit operates.
 7. Current flowing only during data flash rewrite.
 8. Current flowing only during self programming.
 9. For shift time to the SNOOZE mode, see **17.3.3 SNOOZE mode** in the RL78/G12 User's Manual.

- Remarks**
1. f_{IL} : Low-speed on-chip oscillator clock frequency
 2. Temperature condition of the TYP. value is $T_A = 25^\circ\text{C}$

2.4 AC Characteristics

 $(T_A = -40$ to $+85^\circ\text{C}$, $1.8\text{ V} \leq V_{DD} \leq 5.5\text{ V}$, $V_{SS} = 0\text{ V}$)

Items	Symbol	Conditions			MIN.	TYP.	MAX.	Unit
Instruction cycle (minimum instruction execution time)	T_{CY}	Main system clock (f_{MAIN}) operation	HS (High-speed main) mode	$2.7\text{ V} \leq V_{DD} \leq 5.5\text{ V}$	0.04167		1	μs
				$2.4\text{ V} \leq V_{DD} < 2.7\text{ V}$	0.0625		1	μs
			LS (Low-speed main) mode	$1.8\text{ V} \leq V_{DD} \leq 5.5\text{ V}$	0.125		1	μs
		During self programming	HS (High-speed main) mode	$2.7\text{ V} \leq V_{DD} \leq 5.5\text{ V}$	0.04167		1	μs
				$2.4\text{ V} \leq V_{DD} < 2.7\text{ V}$	0.0625		1	μs
			LS (Low-speed main) mode	$1.8\text{ V} \leq V_{DD} \leq 5.5\text{ V}$	0.125		1	μs
External main system clock frequency	f_{EX}	$2.7\text{ V} \leq V_{DD} \leq 5.5\text{ V}$		1.0		20.0	MHz	
		$2.4\text{ V} \leq V_{DD} < 2.7\text{ V}$		1.0		16.0	MHz	
		$1.8\text{ V} \leq V_{DD} < 2.4\text{ V}$		1.0		8.0	MHz	
External main system clock input high-level width, low-level width	t_{EXH} , t_{EXL}	$2.7\text{ V} \leq V_{DD} \leq 5.5\text{ V}$		24			ns	
		$2.4\text{ V} \leq V_{DD} < 2.7\text{ V}$		30			ns	
		$1.8\text{ V} \leq V_{DD} < 2.4\text{ V}$		60			ns	
TI00 to TI07 input high-level width, low-level width	t_{TIH} , t_{TIL}				$1/f_{MCK} + 10$			ns
TO00 to TO07 output frequency	f_{TO}	$4.0\text{ V} \leq V_{DD} \leq 5.5\text{ V}$				12	MHz	
		$2.7\text{ V} \leq V_{DD} < 4.0\text{ V}$				8	MHz	
		$1.8\text{ V} \leq V_{DD} < 2.7\text{ V}$				4	MHz	
PCLBUZ0, or PCLBUZ1 output frequency	f_{PCL}	$4.0\text{ V} \leq V_{DD} \leq 5.5\text{ V}$				16	MHz	
		$2.7\text{ V} \leq V_{DD} < 4.0\text{ V}$				8	MHz	
		$1.8\text{ V} \leq V_{DD} < 2.7\text{ V}$				4	MHz	
INTP0 to INTP5 input high-level width, low-level width	t_{INTH} , t_{INTL}				1			μs
KR0 to KR9 input available width	t_{KR}				250			ns
RESET low-level width	t_{RSL}				10			μs

Remark f_{MCK} : Timer array unit operation clock frequency
 (Operation clock to be set by the timer clock select register 0 (TPS0) and the CKS0n bit of timer mode register 0n (TMR0n). n: Channel number (n = 0 to 7))

Minimum Instruction Execution Time during Main System Clock Operation



AC Timing Test Point



External Main System Clock Timing



TI/TO Timing



Interrupt Request Input Timing



Key Interrupt Input Timing



RESET Input Timing



2.5 Peripheral Functions Characteristics

AC Timing Test Point



2.5.1 Serial array unit

(1) During communication at same potential (UART mode)

(T_A = -40 to +85°C, 1.8 V ≤ V_{DD} ≤ 5.5 V, V_{SS} = 0 V)

Parameter	Symbol	Conditions	HS (high-speed main) Mode		LS (low-speed main) Mode		Unit
			MIN.	MAX.	MIN.	MAX.	
Transfer rate				f _{MCK} /6		f _{MCK} /6	bps
Note 1		Theoretical value of the maximum transfer rate f _{CLK} = f _{MCK} ^{Note 2}		4.0		1.3	Mbps

- Notes**
- Transfer rate in the SNOOZE mode is 4800 bps only.
 - The maximum operating frequencies of the CPU/peripheral hardware clock (f_{CLK}) are:
 HS (high-speed main) mode: 24 MHz (2.7 V ≤ V_{DD} ≤ 5.5 V)
 16 MHz (2.4 V ≤ V_{DD} ≤ 5.5 V)
 LS (low-speed main) mode: 8 MHz (1.8 V ≤ V_{DD} ≤ 5.5 V)

Caution Select the normal input buffer for the RxDq pin and the normal output mode for the TxDq pin by using port input mode register g (PIMg) and port output mode register g (POMg).

UART mode connection diagram (during communication at same potential)



UART mode bit width (during communication at same potential) (reference)



- Remarks**
- q: UART number (q = 0 to 2), g: PIM, POM number (g = 0, 1)
 - f_{MCK}: Serial array unit operation clock frequency
 (Operation clock to be set by the serial clock select register m (SPSm) and the CKSmn bit of serial mode register mn (SMRmn).
 m: Unit number, n: Channel number (mn = 00 to 03, 10, 11))

(2) During communication at same potential (simplified SPI (CSI) mode) (master mode, SCK00... internal clock output, corresponding CSI00 only)

(T_A = -40 to +85°C, 2.7 V ≤ V_{DD} ≤ 5.5 V, V_{SS} = 0 V)

Parameter	Symbol	Conditions	HS (high-speed main) Mode		LS (low-speed main) Mode		Unit
			MIN.	MAX.	MIN.	MAX.	
SCK00 cycle time	t _{KCY1}	t _{KCY1} ≥ 2/f _{CLK}	83.3		250		ns
SCK00 high-/low-level width	t _{KH1} , t _{KL1}	4.0 V ≤ V _{DD} ≤ 5.5 V	t _{KCY1} /2-7		t _{KCY1} /2-50		ns
		2.7 V ≤ V _{DD} ≤ 5.5 V	t _{KCY1} /2-10		t _{KCY1} /2-50		ns
SI00 setup time (to SCK00↑) ^{Note 1}	t _{SIK1}	4.0 V ≤ V _{DD} ≤ 5.5 V	23		110		ns
		2.7 V ≤ V _{DD} ≤ 5.5 V	33		110		ns
SI00 hold time (from SCK00↑) ^{Note 2}	t _{KS1}		10		10		ns
Delay time from SCK00↓ to SO00 output ^{Note 3}	t _{KSO1}	C = 20 pF ^{Note 4}		10		10	ns

- Notes**
1. When DAP00 = 0 and CKP00 = 0, or DAP00 = 1 and CKP00 = 1. The SI00 setup time becomes “to SCK00↓” when DAP00 = 0 and CKP00 = 1, or DAP00 = 1 and CKP00 = 0.
 2. When DAP00 = 0 and CKP00 = 0, or DAP00 = 1 and CKP00 = 1. The SI00 hold time becomes “from SCK00↓” when DAP00 = 0 and CKP00 = 1, or DAP00 = 1 and CKP00 = 0.
 3. When DAP00 = 0 and CKP00 = 0, or DAP00 = 1 and CKP00 = 1. The delay time to SO00 output becomes “from SCK00↑” when DAP00 = 0 and CKP00 = 1, or DAP00 = 1 and CKP00 = 0.
 4. C is the load capacitance of the SCK00 and SO00 output lines.

Caution Select the normal input buffer for the SI00 pin and the normal output mode for the SO00 and SCK00 pins by using port input mode register 1 (PIM1) and port output mode register 1 (POM1).

- Remarks**
1. This specification is valid only when CSI00's peripheral I/O redirect function is not used.
 2. f_{MCK}: Serial array unit operation clock frequency
(Operation clock to be set by the serial clock select register 0 (SPS0) and the CKS00 bit of serial mode register 00 (SMR00).)

(3) During communication at same potential (simplified SPI (CSI) mode) (master mode, SCKp... internal clock output)**(T_A = -40 to +85°C, 1.8 V ≤ V_{DD} ≤ 5.5 V, V_{SS} = 0 V)**

Parameter	Symbol	Conditions	HS (high-speed main) Mode		LS (low-speed main) Mode		Unit
			MIN.	MAX.	MIN.	MAX.	
SCKp cycle time	t _{KCY1}	t _{KCY1} ≥ 4/f _{CLK}	2.7 V ≤ V _{DD} ≤ 5.5 V	167		500	ns
			2.4 V ≤ V _{DD} ≤ 5.5 V	250		500	ns
			1.8 V ≤ V _{DD} ≤ 5.5 V	–		500	ns
SCKp high-/low-level width	t _{KH1} ,	4.0 V ≤ V _{DD} ≤ 5.5 V	t _{KCY1} /2–12		t _{KCY1} /2–50		ns
			t _{KL1}	t _{KCY1} /2–18		t _{KCY1} /2–50	ns
	t _{KL1}	2.7 V ≤ V _{DD} ≤ 5.5 V	t _{KCY1} /2–38		t _{KCY1} /2–50		ns
			1.8 V ≤ V _{DD} ≤ 5.5 V	–		t _{KCY1} /2–50	ns
Slp setup time (to SCKp↑) Note 1	t _{SIK1}	4.0 V ≤ V _{DD} ≤ 5.5 V	44		110		ns
		2.7 V ≤ V _{DD} ≤ 5.5 V	44		110	ns	
		2.4 V ≤ V _{DD} ≤ 5.5 V	75		110	ns	
		1.8 V ≤ V _{DD} ≤ 5.5 V	–		110	ns	
Slp hold time (from SCKp↑) Note 2	t _{KS11}		19		19		ns
Delay time from SCKp↓ to SOp output Note 3	t _{KSO1}	C = 30 pF Note 4		25		25	ns

- Notes**
- When DAPmn = 0 and CKPmn = 0, or DAPmn = 1 and CKPmn = 1. The Slp setup time becomes “to SCKp↓” when DAPmn = 0 and CKPmn = 1, or DAPmn = 1 and CKPmn = 0.
 - When DAPmn = 0 and CKPmn = 0, or DAPmn = 1 and CKPmn = 1. The Slp hold time becomes “from SCKp↓” when DAPmn = 0 and CKPmn = 1, or DAPmn = 1 and CKPmn = 0.
 - When DAPmn = 0 and CKPmn = 0, or DAPmn = 1 and CKPmn = 1. The delay time to SOp output becomes “from SCKp↑” when DAPmn = 0 and CKPmn = 1, or DAPmn = 1 and CKPmn = 0.
 - C is the load capacitance of the SCKp and SOp output lines.

Caution Select the normal input buffer for the Slp pin and the normal output mode for the SOp and SCKp pins by using port input mode register 1 (PIM1) and port output mode registers 0, 1, 4 (POM0, POM1, POM4).

- Remarks**
- p: CSI number (p = 00, 01, 11, 20), m: Unit number (m = 0, 1), n: Channel number (n = 0, 1, 3: “1, 3” is only for the R5F102 products)
 - f_{MCK}: Serial array unit operation clock frequency
(Operation clock to be set by the serial clock select register m (SPSm) and the CKSmn bit of serial mode register mn (SMRmn). m: Unit number (m = 0, 1), n: Channel number (n = 0, 1, 3: “1, 3” is only for the R5F102 products.))

(4) During communication at same potential (simplified SPI (CSI) mode) (slave mode, SCKp... external clock input)**($T_A = -40$ to $+85^\circ\text{C}$, $1.8\text{ V} \leq V_{DD} \leq 5.5\text{ V}$, $V_{SS} = 0\text{ V}$)**

Parameter	Symbol	Conditions		HS (high-speed main) Mode		LS (low-speed main) Mode		Unit
				MIN.	MAX.	MIN.	MAX.	
SCKp cycle time ^{Note 5}	t_{KCY2}	$4.0\text{ V} \leq V_{DD} \leq 5.5\text{ V}$	$20\text{ MHz} < f_{MCK}$	$8/f_{MCK}$		–		ns
			$f_{MCK} \leq 20\text{ MHz}$	$6/f_{MCK}$		$6/f_{MCK}$		ns
		$2.7\text{ V} \leq V_{DD} \leq 5.5\text{ V}$	$16\text{ MHz} < f_{MCK}$	$8/f_{MCK}$		–		ns
			$f_{MCK} \leq 16\text{ MHz}$	$6/f_{MCK}$		$6/f_{MCK}$		ns
		$2.4\text{ V} \leq V_{DD} \leq 5.5\text{ V}$		$6/f_{MCK}$ and 500		$6/f_{MCK}$ and 500		ns
$1.8\text{ V} \leq V_{DD} \leq 5.5\text{ V}$		–		$6/f_{MCK}$ and 750		ns		
SCKp high-/low-level width	t_{KH2}	$4.0\text{ V} \leq V_{DD} \leq 5.5\text{ V}$		$t_{KCY2}/2-7$		$t_{KCY2}/2-7$		ns
		$2.7\text{ V} \leq V_{DD} \leq 5.5\text{ V}$		$t_{KCY2}/2-8$		$t_{KCY2}/2-8$		ns
	$2.4\text{ V} \leq V_{DD} \leq 5.5\text{ V}$		$t_{KCY2}/2-18$		$t_{KCY2}/2-18$		ns	
	$1.8\text{ V} \leq V_{DD} \leq 5.5\text{ V}$		–		$t_{KCY2}/2-18$		ns	
Slp setup time (to SCKp \uparrow) ^{Note 1}	t_{SIK2}	$2.7\text{ V} \leq V_{DD} \leq 5.5\text{ V}$		$1/f_{MCK} + 20$		$1/f_{MCK} + 30$		ns
		$2.4\text{ V} \leq V_{DD} \leq 5.5\text{ V}$		$1/f_{MCK} + 30$		$1/f_{MCK} + 30$		ns
		$1.8\text{ V} \leq V_{DD} \leq 5.5\text{ V}$		–		$1/f_{MCK} + 30$		ns
Slp hold time (from SCKp \uparrow) ^{Note 2}	t_{SI2}			$1/f_{MCK} + 31$		$1/f_{MCK} + 31$		ns
Delay time from SCKp \downarrow to SOp output ^{Note 3}	t_{KSO2}	$C = 30\text{ pF}$ ^{Note 4}	$2.7\text{ V} \leq V_{DD} \leq 5.5\text{ V}$		$2/f_{MCK} + 44$		$2/f_{MCK} + 110$	ns
			$2.4\text{ V} \leq V_{DD} \leq 5.5\text{ V}$		$2/f_{MCK} + 75$		$2/f_{MCK} + 110$	ns
			$1.8\text{ V} \leq V_{DD} \leq 5.5\text{ V}$		–		$2/f_{MCK} + 110$	ns

- Notes**
1. When $DAP_{mn} = 0$ and $CKP_{mn} = 0$, or $DAP_{mn} = 1$ and $CKP_{mn} = 1$. The Slp setup time becomes “to SCKp \downarrow ” when $DAP_{mn} = 0$ and $CKP_{mn} = 1$, or $DAP_{mn} = 1$ and $CKP_{mn} = 0$.
 2. When $DAP_{mn} = 0$ and $CKP_{mn} = 0$, or $DAP_{mn} = 1$ and $CKP_{mn} = 1$. The Slp hold time becomes “from SCKp \downarrow ” when $DAP_{mn} = 0$ and $CKP_{mn} = 1$, or $DAP_{mn} = 1$ and $CKP_{mn} = 0$.
 3. When $DAP_{mn} = 0$ and $CKP_{mn} = 0$, or $DAP_{mn} = 1$ and $CKP_{mn} = 1$. The delay time to SOp output becomes “from SCKp \uparrow ” when $DAP_{mn} = 0$ and $CKP_{mn} = 1$, or $DAP_{mn} = 1$ and $CKP_{mn} = 0$.
 4. C is the load capacitance of the SOp output lines.
 5. Transfer rate in the SNOOZE mode: MAX. 1 Mbps.

Caution Select the normal input buffer for the Slp and SCKp pins and the normal output mode for the SOp pin by using port input mode register 1 (PIM1) and port output mode registers 0, 1, 4 (POM0, POM1, POM4).

Simplified SPI (CSI) mode connection diagram (during communication at same potential)

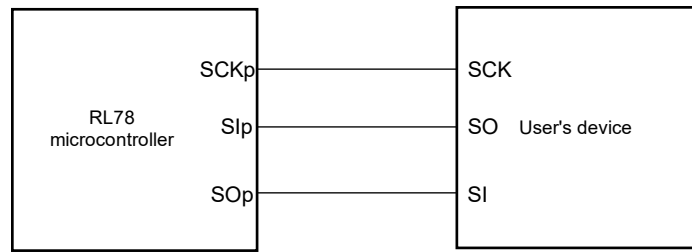

Simplified SPI (CSI) mode serial transfer timing (during communication at same potential)
 (When $DAPmn = 0$ and $CKPmn = 0$, or $DAPmn = 1$ and $CKPmn = 1$.)

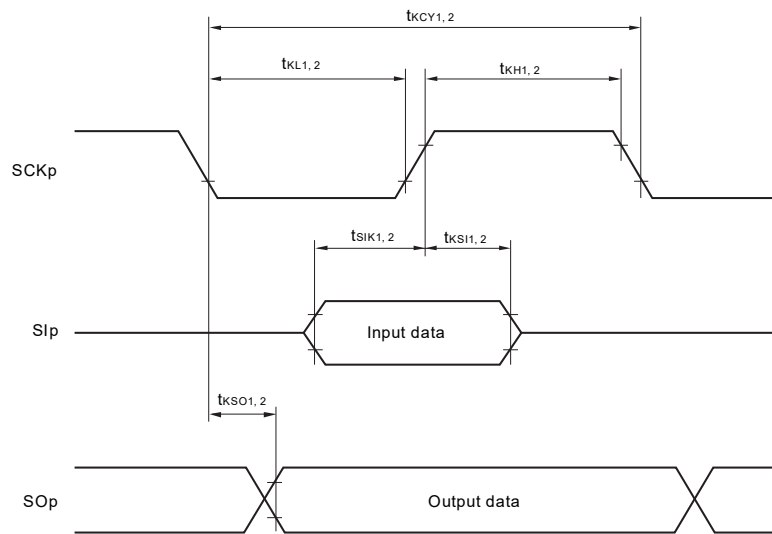

Simplified SPI (CSI) mode serial transfer timing (during communication at same potential)
 (When $DAPmn = 0$ and $CKPmn = 1$, or $DAPmn = 1$ and $CKPmn = 0$.)

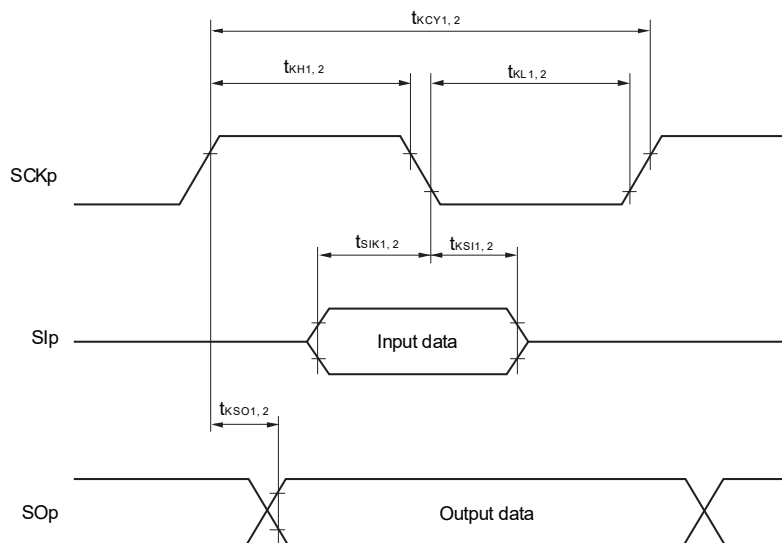

(Remarks are listed on the next page.)

- Remarks 1.** p: CSI number (p = 00, 01, 11, 20), m: Unit number (m = 0, 1), n: Channel number (n = 0, 1, 3: "1, 3" is only for the R5F102 products.)
- 2.** f_{MCK} : Serial array unit operation clock frequency
(Operation clock to be set by the serial clock select register m (SPSm) and the CKSmn bit of serial mode register mn (SMRmn). m: Unit number (m = 0, 1), n: Channel number (n = 0, 1, 3: "1, 3" is only for the R5F102 products.))

(5) During communication at same potential (simplified I²C mode)

($T_A = -40$ to $+85^\circ\text{C}$, $1.8\text{ V} \leq V_{DD} \leq 5.5\text{ V}$, $V_{SS} = 0\text{ V}$)

Parameter	Symbol	Conditions	HS (high-speed main) Mode LS (low-speed main) Mode		Unit
			MIN.	MAX.	
SCLr clock frequency	f_{SCL}	$1.8\text{ V} \leq V_{DD} \leq 5.5\text{ V}$, $C_b = 100\text{ pF}$, $R_b = 3\text{ k}\Omega$		400 ^{Note 1}	kHz
		$1.8\text{ V} \leq V_{DD} < 2.7\text{ V}$, $C_b = 100\text{ pF}$, $R_b = 5\text{ k}\Omega$		300 ^{Note 1}	kHz
Hold time when SCLr = "L"	t_{LOW}	$1.8\text{ V} \leq V_{DD} \leq 5.5\text{ V}$, $C_b = 100\text{ pF}$, $R_b = 3\text{ k}\Omega$	1150		ns
		$1.8\text{ V} \leq V_{DD} < 2.7\text{ V}$, $C_b = 100\text{ pF}$, $R_b = 5\text{ k}\Omega$	1550		ns
Hold time when SCLr = "H"	t_{HIGH}	$1.8\text{ V} \leq V_{DD} \leq 5.5\text{ V}$, $C_b = 100\text{ pF}$, $R_b = 3\text{ k}\Omega$	1150		ns
		$1.8\text{ V} \leq V_{DD} < 2.7\text{ V}$, $C_b = 100\text{ pF}$, $R_b = 5\text{ k}\Omega$	1550		ns
Data setup time (reception)	$t_{SU:DAT}$	$1.8\text{ V} \leq V_{DD} \leq 5.5\text{ V}$, $C_b = 100\text{ pF}$, $R_b = 3\text{ k}\Omega$	$1/f_{MCK} + 145$ ^{Note 2}		ns
		$1.8\text{ V} \leq V_{DD} < 2.7\text{ V}$, $C_b = 100\text{ pF}$, $R_b = 5\text{ k}\Omega$	$1/f_{MCK} + 230$ ^{Note 2}		ns
Data hold time (transmission)	$t_{HD:DAT}$	$1.8\text{ V} \leq V_{DD} \leq 5.5\text{ V}$, $C_b = 100\text{ pF}$, $R_b = 3\text{ k}\Omega$	0	355	ns
		$1.8\text{ V} \leq V_{DD} < 2.7\text{ V}$, $C_b = 100\text{ pF}$, $R_b = 5\text{ k}\Omega$	0	405	ns

- Notes 1.** The value must be equal to or less than $f_{MCK}/4$.
- 2.** Set $t_{SU:DAT}$ so that it will not exceed the hold time when SCLr = "L" or SCLr = "H".

Caution Select the N-ch open drain output (V_{DD} tolerance) mode for SDAr by using port output mode register h (POMh).

(Remarks are listed on the next page.)

Simplified I²C mode connection diagram (during communication at same potential)Simplified I²C mode serial transfer timing (during communication at same potential)

- Remarks**
1. R_b [Ω]: Communication line (SDAr) pull-up resistance
 C_b [F]: Communication line (SCLr, SDAr) load capacitance
 2. r: IIC number (r = 00, 01, 11, 20), h: = POM number (h = 0, 1, 4, 5)
 3. f_{MCK} : Serial array unit operation clock frequency
 (Operation clock to be set by the serial clock select register m (SPSm) and the CKSmn bit of serial mode register mn (SMRmn). m: Unit number (m = 0, 1), n: Channel number (0, 1, 3))
 4. Simplified I²C mode is supported only by the R5F102 products.

(6) Communication at different potential (1.8 V, 2.5 V, 3 V) (UART mode)

(T_A = -40 to +85°C, 1.8 V ≤ V_{DD} ≤ 5.5 V, V_{SS} = 0 V)

Parameter	Symbol	Conditions	HS (high-speed main) Mode		LS (low-speed main) Mode		Unit		
			MIN.	MAX.	MIN.	MAX.			
Transfer rate ^{Note4}		Reception	4.0 V ≤ V _{DD} ≤ 5.5 V, 2.7 V ≤ V _b ≤ 4.0 V		f _{MCK} /6 Note1		f _{MCK} /6 Note1	bps	
			Theoretical value of the maximum transfer rate f _{MCK} = f _{CLK} Note3		4.0		1.3	Mbps	
			2.7 V ≤ V _{DD} < 4.0 V, 2.3 V ≤ V _b ≤ 2.7 V		f _{MCK} /6 Note1		f _{MCK} /6 Note1	bps	
				Theoretical value of the maximum transfer rate f _{MCK} = f _{CLK} Note3		4.0		1.3	Mbps
		1.8 V ≤ V _{DD} < 3.3 V, 1.6 V ≤ V _b ≤ 2.0 V		f _{MCK} /6 Notes1, 2		f _{MCK} /6 Notes1, 2	bps		
				Theoretical value of the maximum transfer rate f _{MCK} = f _{CLK} Note3		4.0		1.3	Mbps
		Transmission	4.0 V ≤ V _{DD} ≤ 5.5 V, 2.7 V ≤ V _b ≤ 4.0 V		Note4		Note4	bps	
			Theoretical value of the maximum transfer rate C _b = 50 pF, R _b = 1.4 kΩ, V _b = 2.7 V		2.8 Note5		2.8 Note5	Mbps	
			2.7 V ≤ V _{DD} < 4.0 V, 2.3 V ≤ V _b ≤ 2.7 V		Note6		Note6	bps	
			Theoretical value of the maximum transfer rate C _b = 50 pF, R _b = 2.7 kΩ, V _b = 2.3 V		1.2 Note7		1.2 Note7	Mbps	
			1.8 V ≤ V _{DD} < 3.3 V, 1.6 V ≤ V _b ≤ 2.0 V		Notes 2, 8		Notes 2, 8	bps	
				Theoretical value of the maximum transfer rate C _b = 50 pF, R _b = 5.5 kΩ, V _b = 1.6 V		0.43 Note9		0.43 Note9	Mbps

- Notes**
- Transfer rate in the SNOOZE mode is 4800 bps only.
 - Use it with V_{DD} ≥ V_b.
 - The maximum operating frequencies of the CPU/peripheral hardware clock (f_{CLK}) are:
 HS (high-speed main) mode: 24 MHz (2.7 V ≤ V_{DD} ≤ 5.5 V)
 16 MHz (2.4 V ≤ V_{DD} ≤ 5.5 V)
 LS (low-speed main) mode: 8 MHz (1.8 V ≤ V_{DD} ≤ 5.5 V)
 - The smaller maximum transfer rate derived by using f_{MCK}/6 or the following expression is the valid maximum transfer rate.
 Expression for calculating the transfer rate when 4.0 V ≤ V_{DD} ≤ 5.5 V and 2.7 V ≤ V_b ≤ 4.0 V

$$\text{Maximum transfer rate} = \frac{1}{\{-C_b \times R_b \times \ln(1 - \frac{2.2}{V_b})\} \times 3} \text{ [bps]}$$

$$\text{Baud rate error (theoretical value)} = \frac{\frac{1}{\text{Transfer rate} \times 2} - \{-C_b \times R_b \times \ln(1 - \frac{2.2}{V_b})\}}{(\frac{1}{\text{Transfer rate}}) \times \text{Number of transferred bits}} \times 100 \text{ [%]}$$

* This value is the theoretical value of the relative difference between the transmission and reception sides.

5. This value as an example is calculated when the conditions described in the “Conditions” column are met. Refer to **Note 4** above to calculate the maximum transfer rate under conditions of the customer.

6. The smaller maximum transfer rate derived by using $f_{MCK}/6$ or the following expression is the valid maximum transfer rate.

Expression for calculating the transfer rate when $2.7\text{ V} \leq V_{DD} < 4.0\text{ V}$ and $2.3\text{ V} \leq V_b \leq 2.7\text{ V}$

$$\text{Maximum transfer rate} = \frac{1}{\{-C_b \times R_b \times \ln(1 - \frac{2.0}{V_b})\} \times 3} \quad [\text{bps}]$$

$$\text{Baud rate error (theoretical value)} = \frac{\frac{1}{\text{Transfer rate} \times 2} - \{-C_b \times R_b \times \ln(1 - \frac{2.0}{V_b})\}}{(\frac{1}{\text{Transfer rate}}) \times \text{Number of transferred bits}} \times 100 [\%]$$

* This value is the theoretical value of the relative difference between the transmission and reception sides.

7. This value as an example is calculated when the conditions described in the “Conditions” column are met. Refer to **Note 6** above to calculate the maximum transfer rate under conditions of the customer.

8. The smaller maximum transfer rate derived by using $f_{MCK}/6$ or the following expression is the valid maximum transfer rate.

Expression for calculating the transfer rate when $1.8\text{ V} \leq V_{DD} < 3.3\text{ V}$, $1.6\text{ V} \leq V_b \leq 2.0\text{ V}$

$$\text{Maximum transfer rate} = \frac{1}{\{-C_b \times R_b \times \ln(1 - \frac{1.5}{V_b})\} \times 3} \quad [\text{bps}]$$

$$\text{Baud rate error (theoretical value)} = \frac{\frac{1}{\text{Transfer rate} \times 2} - \{-C_b \times R_b \times \ln(1 - \frac{1.5}{V_b})\}}{(\frac{1}{\text{Transfer rate}}) \times \text{Number of transferred bits}} \times 100 [\%]$$

* This value is the theoretical value of the relative difference between the transmission and reception sides.

9. This value as an example is calculated when the conditions described in the “Conditions” column are met. Refer to **Note 8** above to calculate the maximum transfer rate under conditions of the customer.

Caution Select the TTL input buffer for the RxDq pin and the N-ch open drain output (V_{DD} tolerance) mode for the TxDq pin by using port input mode register g (PIMg) and port output mode register g (POMg). For V_{IH} and V_{IL}, see the DC characteristics with TTL input buffer selected.

UART mode connection diagram (during communication at different potential)



UART mode bit width (during communication at different potential) (reference)



- Remarks**
1. $R_b[\Omega]$: Communication line (TxDq) pull-up resistance, $C_b[F]$: Communication line (TxDq) load capacitance, $V_b[V]$: Communication line voltage
 2. q: UART number (q = 0 to 2), g: PIM and POM number (g = 0, 1)
 3. f_{MCK} : Serial array unit operation clock frequency
(Operation clock to be set by the serial clock select register m (SPSm) and the CKSmn bit of serial mode register mn (SMRmn).
m: Unit number, n: Channel number (mn = 00 to 03, 10, 11))
 4. UART0 of the 20- and 24-pin products supports communication at different potential only when the peripheral I/O redirection function is not used.

(7) Communication at different potential (2.5 V, 3 V) (simplified SPI (CSI) mode) (master mode, SCK00... internal clock output, corresponding CSI00 only)

 $(T_A = -40$ to $+85^\circ\text{C}$, $2.7\text{ V} \leq V_{DD} \leq 5.5\text{ V}$, $V_{SS} = 0\text{ V})$

Parameter	Symbol	Conditions	HS (high-speed main) Mode		LS (low-speed main) Mode		Unit
			MIN.	MAX.	MIN.	MAX.	
SCK00 cycle time	t_{KCY1}	$t_{KCY1} \geq 2/f_{CLK}$ $4.0\text{ V} \leq V_{DD} \leq 5.5\text{ V}$, $2.7\text{ V} \leq V_b \leq 4.0\text{ V}$, $C_b = 20\text{ pF}$, $R_b = 1.4\text{ k}\Omega$	200		1150		ns
			300		1150		ns
SCK00 high-level width	t_{KH1}	$4.0\text{ V} \leq V_{DD} \leq 5.5\text{ V}$, $2.7\text{ V} \leq V_b \leq 4.0\text{ V}$, $C_b = 20\text{ pF}$, $R_b = 1.4\text{ k}\Omega$	$t_{KCY1}/2 - 50$		$t_{KCY1}/2 - 50$		ns
		$2.7\text{ V} \leq V_{DD} < 4.0\text{ V}$, $2.3\text{ V} \leq V_b \leq 2.7\text{ V}$, $C_b = 20\text{ pF}$, $R_b = 2.7\text{ k}\Omega$	$t_{KCY1}/2 - 120$		$t_{KCY1}/2 - 120$		ns
SCK00 low-level width	t_{KL1}	$4.0\text{ V} \leq V_{DD} \leq 5.5\text{ V}$, $2.7\text{ V} \leq V_b \leq 4.0\text{ V}$, $C_b = 20\text{ pF}$, $R_b = 1.4\text{ k}\Omega$	$t_{KCY1}/2 - 7$		$t_{KCY1}/2 - 50$		ns
		$2.7\text{ V} \leq V_{DD} < 4.0\text{ V}$, $2.3\text{ V} \leq V_b \leq 2.7\text{ V}$, $C_b = 20\text{ pF}$, $R_b = 2.7\text{ k}\Omega$	$t_{KCY1}/2 - 10$		$t_{KCY1}/2 - 50$		ns
SI00 setup time (to SCK00 \uparrow) ^{Note 1}	t_{SIK1}	$4.0\text{ V} \leq V_{DD} \leq 5.5\text{ V}$, $2.7\text{ V} \leq V_b \leq 4.0\text{ V}$, $C_b = 20\text{ pF}$, $R_b = 1.4\text{ k}\Omega$	58		479		ns
		$2.7\text{ V} \leq V_{DD} < 4.0\text{ V}$, $2.3\text{ V} \leq V_b \leq 2.7\text{ V}$, $C_b = 20\text{ pF}$, $R_b = 2.7\text{ k}\Omega$	121		479		ns
SI00 hold time (from SCK00 \uparrow) ^{Note 1}	t_{KSI1}	$4.0\text{ V} \leq V_{DD} \leq 5.5\text{ V}$, $2.7\text{ V} \leq V_b \leq 4.0\text{ V}$, $C_b = 20\text{ pF}$, $R_b = 1.4\text{ k}\Omega$	10		10		ns
		$2.7\text{ V} \leq V_{DD} < 4.0\text{ V}$, $2.3\text{ V} \leq V_b \leq 2.7\text{ V}$, $C_b = 20\text{ pF}$, $R_b = 2.7\text{ k}\Omega$	10		10		ns
Delay time from SCK00 \downarrow to SO00 output ^{Note 1}	t_{KSO1}	$4.0\text{ V} \leq V_{DD} \leq 5.5\text{ V}$, $2.7\text{ V} \leq V_b \leq 4.0\text{ V}$, $C_b = 20\text{ pF}$, $R_b = 1.4\text{ k}\Omega$		60		60	ns
		$2.7\text{ V} \leq V_{DD} < 4.0\text{ V}$, $2.3\text{ V} \leq V_b \leq 2.7\text{ V}$, $C_b = 20\text{ pF}$, $R_b = 2.7\text{ k}\Omega$		130		130	ns
SI00 setup time (to SCK00 \downarrow) ^{Note 2}	t_{SIK1}	$4.0\text{ V} \leq V_{DD} \leq 5.5\text{ V}$, $2.7\text{ V} \leq V_b \leq 4.0\text{ V}$, $C_b = 20\text{ pF}$, $R_b = 1.4\text{ k}\Omega$	23		110		ns
		$2.7\text{ V} \leq V_{DD} < 4.0\text{ V}$, $2.3\text{ V} \leq V_b \leq 2.7\text{ V}$, $C_b = 20\text{ pF}$, $R_b = 2.7\text{ k}\Omega$	33		110		ns
SI00 hold time (from SCK00 \downarrow) ^{Note 2}	t_{KSI1}	$4.0\text{ V} \leq V_{DD} \leq 5.5\text{ V}$, $2.7\text{ V} \leq V_b \leq 4.0\text{ V}$, $C_b = 20\text{ pF}$, $R_b = 1.4\text{ k}\Omega$	10		10		ns
		$2.7\text{ V} \leq V_{DD} < 4.0\text{ V}$, $2.3\text{ V} \leq V_b \leq 2.7\text{ V}$, $C_b = 20\text{ pF}$, $R_b = 2.7\text{ k}\Omega$	10		10		ns
Delay time from SCK00 \uparrow to SO00 output ^{Note 2}	t_{KSO1}	$4.0\text{ V} \leq V_{DD} \leq 5.5\text{ V}$, $2.7\text{ V} \leq V_b \leq 4.0\text{ V}$, $C_b = 20\text{ pF}$, $R_b = 1.4\text{ k}\Omega$		10		10	ns
		$2.7\text{ V} \leq V_{DD} < 4.0\text{ V}$, $2.3\text{ V} \leq V_b \leq 2.7\text{ V}$, $C_b = 20\text{ pF}$, $R_b = 2.7\text{ k}\Omega$		10		10	ns

(Notes, Caution, and Remarks are listed on the next page.)

- Notes**
1. When DAP00 = 0 and CKP00 = 0, or DAP00 = 1 and CKP00 = 1
 2. When DAP00 = 0 and CKP00 = 1, or DAP00 = 1 and CKP00 = 0.

Caution Select the TTL input buffer for the SI00 pin and the N-ch open drain output (V_{DD} tolerance) mode for the SO00 pin and SCK00 pin by using port input mode register 1 (PIM1) and port output mode register 1 (POM1). For V_{IH} and V_{IL} , see the DC characteristics with TTL input buffer selected.

- Remarks**
1. R_b [Ω]: Communication line (SCK00, SO00) pull-up resistance, C_b [F]: Communication line (SCK00, SO00) load capacitance, V_b [V]: Communication line voltage
 2. f_{MCK} : Serial array unit operation clock frequency
(Operation clock to be set by the serial clock select register 0 (SPS0) and the CKS00 bit of serial mode register 00 (SMR00).)

(8) Communication at different potential (1.8 V, 2.5 V, 3 V) (simplified SPI (CSI) mode) (master mode, SCKp... internal clock output) (1/3)**($T_A = -40$ to $+85^\circ\text{C}$, $1.8\text{ V} \leq V_{DD} \leq V_{DD} \leq 5.5\text{ V}$, $V_{SS} = 0\text{ V}$)**

Parameter	Symbol	Conditions		HS (high-speed main) Mode		LS (low-speed main) Mode		Unit
				MIN.	MAX.	MIN.	MAX.	
SCKp cycle time	t_{KCY1}	$t_{KCY1} \geq 4/f_{CLK}$	$4.0\text{ V} \leq V_{DD} \leq 5.5\text{ V}$, $2.7\text{ V} \leq V_b \leq 4.0\text{ V}$, $C_b = 30\text{ pF}$, $R_b = 1.4\text{ k}\Omega$	300		1150		ns
			$2.7\text{ V} \leq V_{DD} < 4.0\text{ V}$, $2.3\text{ V} \leq V_b \leq 2.7\text{ V}$, $C_b = 30\text{ pF}$, $R_b = 2.7\text{ k}\Omega$	500		1150		ns
			$1.8\text{ V} \leq V_{DD} < 3.3\text{ V}$, $1.6\text{ V} \leq V_b \leq 2.0\text{ V}$ ^{Note} , $C_b = 30\text{ pF}$, $R_b = 5.5\text{ k}\Omega$	1150		1150		ns
SCKp high-level width	t_{KH1}		$4.0\text{ V} \leq V_{DD} \leq 5.5\text{ V}$, $2.7\text{ V} \leq V_b \leq 4.0\text{ V}$, $C_b = 30\text{ pF}$, $R_b = 1.4\text{ k}\Omega$	$t_{KCY1}/2 - 75$		$t_{KCY1}/2 - 75$		ns
			$2.7\text{ V} \leq V_{DD} < 4.0\text{ V}$, $2.3\text{ V} \leq V_b \leq 2.7\text{ V}$, $C_b = 30\text{ pF}$, $R_b = 2.7\text{ k}\Omega$	$t_{KCY1}/2 - 170$		$t_{KCY1}/2 - 170$		ns
			$1.8\text{ V} \leq V_{DD} < 3.3\text{ V}$, $1.6\text{ V} \leq V_b \leq 2.0\text{ V}$ ^{Note} , $C_b = 30\text{ pF}$, $R_b = 5.5\text{ k}\Omega$	$t_{KCY1}/2 - 458$		$t_{KCY1}/2 - 458$		ns
SCKp low-level width	t_{KL1}		$4.0\text{ V} \leq V_{DD} \leq 5.5\text{ V}$, $2.7\text{ V} \leq V_b \leq 4.0\text{ V}$, $C_b = 30\text{ pF}$, $R_b = 1.4\text{ k}\Omega$	$t_{KCY1}/2 - 12$		$t_{KCY1}/2 - 50$		ns
			$2.7\text{ V} \leq V_{DD} < 4.0\text{ V}$, $2.3\text{ V} \leq V_b \leq 2.7\text{ V}$, $C_b = 30\text{ pF}$, $R_b = 2.7\text{ k}\Omega$	$t_{KCY1}/2 - 18$		$t_{KCY1}/2 - 50$		ns
			$1.8\text{ V} \leq V_{DD} < 3.3\text{ V}$, $1.6\text{ V} \leq V_b \leq 2.0\text{ V}$ ^{Note} , $C_b = 30\text{ pF}$, $R_b = 5.5\text{ k}\Omega$	$t_{KCY1}/2 - 50$		$t_{KCY1}/2 - 50$		ns

Note Use it with $V_{DD} \geq V_b$.

Cautions 1. Select the TTL input buffer for the SIp pin and the N-ch open drain output (V_{DD} tolerance) mode for the SOp pin and SCKp pin by using port input mode register 1 (PIM1) and port output mode register 1 (POM1). For V_{IH} and V_{IL} , see the DC characteristics with TTL input buffer selected.

2. CSI01 and CSI11 cannot communicate at different potential.

Remarks 1. R_b [Ω]: Communication line (SCKp, SOp) pull-up resistance, C_b [F]: Communication line (SCKp, SOp) load capacitance, V_b [V]: Communication line voltage

2. p: CSI number (p = 00, 20)

(8) Communication at different potential (1.8 V, 2.5 V, 3 V) (simplified SPI (CSI) mode) (master mode, SCKp... internal clock output) (2/3)**($T_A = -40$ to $+85^\circ\text{C}$, $1.8\text{ V} \leq V_{DD} \leq 5.5\text{ V}$, $V_{SS} = 0\text{ V}$)**

Parameter	Symbol	Conditions	HS (high-speed main) Mode		LS (low-speed main) Mode		Unit
			MIN.	MAX.	MIN.	MAX.	
Slp setup time (to SCKp \uparrow) ^{Note 1}	t _{SIK1}	4.0 V \leq V _{DD} \leq 5.5 V, 2.7 V \leq V _b \leq 4.0 V, C _b = 30 pF, R _b = 1.4 k Ω	81		479		ns
		2.7 V \leq V _{DD} < 4.0 V, 2.3 V \leq V _b \leq 2.7 V, C _b = 30 pF, R _b = 2.7 k Ω	177		479		ns
		1.8 V \leq V _{DD} < 3.3 V, 1.6 V \leq V _b \leq 2.0 V ^{Note 2} , C _b = 30 pF, R _b = 5.5 k Ω	479		479		ns
Slp hold time (from SCKp \uparrow) ^{Note 1}	t _{SI1}	4.0 V \leq V _{DD} \leq 5.5 V, 2.7 V \leq V _b \leq 4.0 V, C _b = 30 pF, R _b = 1.4 k Ω	19		19		ns
		2.7 V \leq V _{DD} < 4.0 V, 2.3 V \leq V _b \leq 2.7 V, C _b = 30 pF, R _b = 2.7 k Ω	19		19		ns
		1.8 V \leq V _{DD} < 3.3 V, 1.6 V \leq V _b \leq 2.0 V ^{Note 2} , C _b = 30 pF, R _b = 5.5 k Ω	19		19		ns
Delay time from SCKp \downarrow to SOp output ^{Note 1}	t _{KSO1}	4.0 V \leq V _{DD} \leq 5.5 V, 2.7 V \leq V _b \leq 4.0 V, C _b = 30 pF, R _b = 1.4 k Ω		100		100	ns
		2.7 V \leq V _{DD} < 4.0 V, 2.3 V \leq V _b \leq 2.7 V, C _b = 30 pF, R _b = 2.7 k Ω		195		195	ns
		1.8 V \leq V _{DD} < 3.3 V, 1.6 V \leq V _b \leq 2.0 V ^{Note 2} , C _b = 30 pF, R _b = 5.5 k Ω		483		483	ns

Notes 1. When DAPmn = 0 and CKPmn = 0, or DAPmn = 1 and CKPmn = 1.2. Use it with $V_{DD} \geq V_b$.**(Cautions and Remarks are listed on the next page.)**

(8) Communication at different potential (1.8 V, 2.5 V, 3 V) (simplified SPI (CSI) mode) (master mode, SCKp... internal clock output) (3/3)

(T_A = -40 to +85°C, 1.8 V ≤ V_{DD} ≤ 5.5 V, V_{SS} = 0 V)

Parameter	Symbol	Conditions	HS (high-speed main) Mode		LS (low-speed main) Mode		Unit
			MIN.	MAX.	MIN.	MAX.	
Slp setup time (to SCKp↓) ^{Note 1}	t _{SIK1}	4.0 V ≤ V _{DD} ≤ 5.5 V, 2.7 V ≤ V _b ≤ 4.0 V, C _b = 30 pF, R _b = 1.4 kΩ	44		110		ns
		2.7 V ≤ V _{DD} < 4.0 V, 2.3 V ≤ V _b ≤ 2.7 V, C _b = 30 pF, R _b = 2.7 kΩ	44		110		ns
		1.8 V ≤ V _{DD} < 3.3 V, 1.6 V ≤ V _b ≤ 2.0 V ^{Note 2} , C _b = 30 pF, R _b = 5.5 kΩ	110		110		ns
Slp hold time (from SCKp↓) ^{Note 1}	t _{SI1}	4.0 V ≤ V _{DD} ≤ 5.5 V, 2.7 V ≤ V _b ≤ 4.0 V, C _b = 30 pF, R _b = 1.4 kΩ	19		19		ns
		2.7 V ≤ V _{DD} < 4.0 V, 2.3 V ≤ V _b ≤ 2.7 V, C _b = 30 pF, R _b = 2.7 kΩ	19		19		ns
		1.8 V ≤ V _{DD} < 3.3 V, 1.6 V ≤ V _b ≤ 2.0 V ^{Note 2} , C _b = 30 pF, R _b = 5.5 kΩ	19		19		ns
Delay time from SCKp↑ to SOp output ^{Note 1}	t _{KSO1}	4.0 V ≤ V _{DD} ≤ 5.5 V, 2.7 V ≤ V _b ≤ 4.0 V, C _b = 30 pF, R _b = 1.4 kΩ		25		25	ns
		2.7 V ≤ V _{DD} < 4.0 V, 2.3 V ≤ V _b ≤ 2.7 V, C _b = 30 pF, R _b = 2.7 kΩ		25		25	ns
		1.8 V ≤ V _{DD} < 3.3 V, 1.6 V ≤ V _b ≤ 2.0 V ^{Note 2} , C _b = 30 pF, R _b = 5.5 kΩ		25		25	ns

- Notes**
- When DAP_{mn} = 0 and CKP_{mn} = 1, or DAP_{mn} = 1 and CKP_{mn} = 0.
 - Use it with V_{DD} ≥ V_b.

- Cautions**
- Select the TTL input buffer for the Slp pin and the N-ch open drain output (V_{DD} tolerance) mode for the SOp pin and SCKp pin by using port input mode register 1 (PIM1) and port output mode register 1 (POM1). For V_{IH} and V_{IL}, see the DC characteristics with TTL input buffer selected.
 - CSI01 and CSI11 cannot communicate at different potential.

- Remarks**
- R_b [Ω]: Communication line (SCKp, SOp) pull-up resistance, C_b [F]: Communication line (SCKp, SOp) load capacitance, V_b [V]: Communication line voltage
 - p: CSI number (p = 00, 20), m: Unit number (m = 0, 1), n: Channel number (n = 0)

Simplified SPI (CSI) mode connection diagram (during communication at different potential)

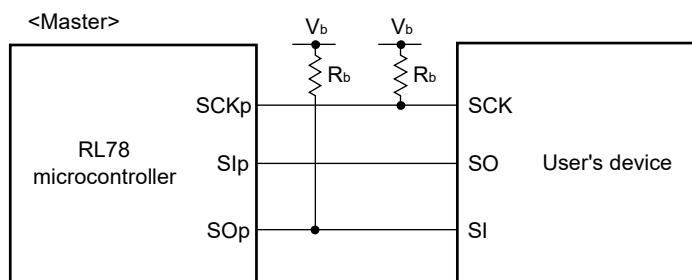

**Simplified SPI (CSI) mode serial transfer timing (master mode) (during communication at different potential)
(When DAPmn = 0 and CKPmn = 0, or DAPmn = 1 and CKPmn = 1)**



**Simplified SPI (CSI) mode serial transfer timing (master mode) (during communication at different potential)
(When DAPmn = 0 and CKPmn = 1, or DAPmn = 1 and CKPmn = 0.)**



(9) Communication at different potential (1.8 V, 2.5 V, 3 V) (simplified SPI (CSI) mode) (slave mode, SCKp... external clock input)**($T_A = -40$ to $+85^\circ\text{C}$, $1.8\text{ V} \leq V_{DD} \leq 5.5\text{ V}$, $V_{SS} = 0\text{ V}$)**

Parameter	Symbol	Conditions	HS (high-speed main) Mode		LS (low-speed main) Mode		Unit
			MIN.	MAX.	MIN.	MAX.	
SCKp cycle time ^{Note 1}	t_{KCY2}	$4.0\text{ V} \leq V_{DD} \leq 5.5\text{ V}$, $2.7\text{ V} \leq V_b \leq 4.0\text{ V}$	$20\text{ MHz} < f_{MCK} \leq 24\text{ MHz}$	$12/f_{MCK}$		–	ns
			$8\text{ MHz} < f_{MCK} \leq 20\text{ MHz}$	$10/f_{MCK}$		–	ns
			$4\text{ MHz} < f_{MCK} \leq 8\text{ MHz}$	$8/f_{MCK}$		$16/f_{MCK}$	ns
			$f_{MCK} \leq 4\text{ MHz}$	$6/f_{MCK}$		$10/f_{MCK}$	ns
		$2.7\text{ V} \leq V_{DD} < 4.0\text{ V}$, $2.3\text{ V} \leq V_b \leq 2.7\text{ V}$	$20\text{ MHz} < f_{MCK} \leq 24\text{ MHz}$	$16/f_{MCK}$		–	ns
			$16\text{ MHz} < f_{MCK} \leq 20\text{ MHz}$	$14/f_{MCK}$		–	ns
			$8\text{ MHz} < f_{MCK} \leq 16\text{ MHz}$	$12/f_{MCK}$		–	ns
			$4\text{ MHz} < f_{MCK} \leq 8\text{ MHz}$	$8/f_{MCK}$		$16/f_{MCK}$	ns
		$1.8\text{ V} \leq V_{DD} < 3.3\text{ V}$, $1.6\text{ V} \leq V_b \leq 2.0\text{ V}$ ^{Note 2}	$20\text{ MHz} < f_{MCK} \leq 24\text{ MHz}$	$36/f_{MCK}$		–	ns
			$16\text{ MHz} < f_{MCK} \leq 20\text{ MHz}$	$32/f_{MCK}$		–	ns
			$8\text{ MHz} < f_{MCK} \leq 16\text{ MHz}$	$26/f_{MCK}$		–	ns
			$4\text{ MHz} < f_{MCK} \leq 8\text{ MHz}$	$16/f_{MCK}$		$16/f_{MCK}$	ns
		$f_{MCK} \leq 4\text{ MHz}$	$10/f_{MCK}$		$10/f_{MCK}$	ns	
SCKp high-/low-level width	t_{KH2} , t_{KL2}	$4.0\text{ V} \leq V_{DD} \leq 5.5\text{ V}$, $2.7\text{ V} \leq V_b \leq 4.0\text{ V}$	$t_{KCY2}/2 - 12$		$t_{KCY2}/2 - 50$	ns	
		$2.7\text{ V} \leq V_{DD} < 4.0\text{ V}$, $2.3\text{ V} \leq V_b \leq 2.7\text{ V}$	$t_{KCY2}/2 - 18$		$t_{KCY2}/2 - 50$	ns	
		$1.8\text{ V} \leq V_{DD} < 3.3\text{ V}$, $1.6\text{ V} \leq V_b \leq 2.0\text{ V}$ ^{Note 2}	$t_{KCY2}/2 - 50$		$t_{KCY2}/2 - 50$	ns	
Slp setup time (to SCKp \uparrow) ^{Note 3}	t_{SIK2}	$4.0\text{ V} \leq V_{DD} \leq 5.5\text{ V}$, $2.7\text{ V} \leq V_b \leq 4.0\text{ V}$	$1/f_{MCK} + 20$		$1/f_{MCK} + 30$	ns	
		$2.7\text{ V} \leq V_{DD} < 4.0\text{ V}$, $2.3\text{ V} \leq V_b \leq 2.7\text{ V}$	$1/f_{MCK} + 20$		$1/f_{MCK} + 30$	ns	
		$1.8\text{ V} \leq V_{DD} < 3.3\text{ V}$, $1.6\text{ V} \leq V_b \leq 2.0\text{ V}$ ^{Note 2}	$1/f_{MCK} + 30$		$1/f_{MCK} + 30$	ns	
Slp hold time (from SCKp \uparrow) ^{Note 4}	t_{KSI2}		$1/f_{MCK} + 31$		$1/f_{MCK} + 31$	ns	
Delay time from SCKp \downarrow to SOp output ^{Note 5}	t_{KSO2}	$4.0\text{ V} \leq V_{DD} \leq 5.5\text{ V}$, $2.7\text{ V} \leq V_b \leq 4.0\text{ V}$, $C_b = 30\text{ pF}$, $R_b = 1.4\text{ k}\Omega$		$2/f_{MCK} + 120$		$2/f_{MCK} + 573$	ns
		$2.7\text{ V} \leq V_{DD} < 4.0\text{ V}$, $2.3\text{ V} \leq V_b \leq 2.7\text{ V}$, $C_b = 30\text{ pF}$, $R_b = 2.7\text{ k}\Omega$		$2/f_{MCK} + 214$		$2/f_{MCK} + 573$	ns
		$1.8\text{ V} \leq V_{DD} < 3.3\text{ V}$, $1.6\text{ V} \leq V_b \leq 2.0\text{ V}$ ^{Note 2} , $C_b = 30\text{ pF}$, $R_b = 5.5\text{ k}\Omega$		$2/f_{MCK} + 573$		$2/f_{MCK} + 573$	ns

- Notes**
- Transfer rate in the SNOOZE mode: MAX. 1 Mbps
 - Use it with $V_{DD} \geq V_b$.
 - When $DAPmn = 0$ and $CKPmn = 0$, or $DAPmn = 1$ and $CKPmn = 1$. The Slp setup time becomes “to SCKp \downarrow ” when $DAPmn = 0$ and $CKPmn = 1$, or $DAPmn = 1$ and $CKPmn = 0$.
 - When $DAPmn = 0$ and $CKPmn = 0$, or $DAPmn = 1$ and $CKPmn = 1$. The Slp hold time becomes “from SCKp \downarrow ” when $DAPmn = 0$ and $CKPmn = 1$, or $DAPmn = 1$ and $CKPmn = 0$.
 - When $DAPmn = 0$ and $CKPmn = 0$, or $DAPmn = 1$ and $CKPmn = 1$. The delay time to SOp output becomes “from SCKp \uparrow ” when $DAPmn = 0$ and $CKPmn = 1$, or $DAPmn = 1$ and $CKPmn = 0$.

- Cautions**
- Select the TTL input buffer for the Slp and SCKp pins and the N-ch open drain output (V_{DD} tolerance) mode for the SOp pin by using port input mode register 1 (PIM1) and port output mode register 1 (POM1). For V_{IH} and V_{IL} , see the DC characteristics with TTL input buffer selected.
 - CSI01 and CSI11 cannot communicate at different potential.

Simplified SPI (CSI) mode connection diagram (during communication at different potential)



- Remarks**
- R_b [Ω]: Communication line (SO_p) pull-up resistance, C_b [F]: Communication line (SO_p) load capacitance, V_b [V]: Communication line voltage
 - p : CSI number ($p = 00, 20$), m : Unit number ($m = 0, 1$), n : Channel number ($n = 0$)
 - f_{MCK} : Serial array unit operation clock frequency
(Operation clock to be set by the serial clock select register m (SPS_m) and the CKS_{mn} bit of serial mode register mn (SMR_{mn}). m : Unit number, n : Channel number ($mn = 00, 10$))

Simplified SPI (CSI) mode serial transfer timing (slave mode) (during communication at different potential)
(When DAP_{mn} = 0 and CKP_{mn} = 0, or DAP_{mn} = 1 and CKP_{mn} = 1.)

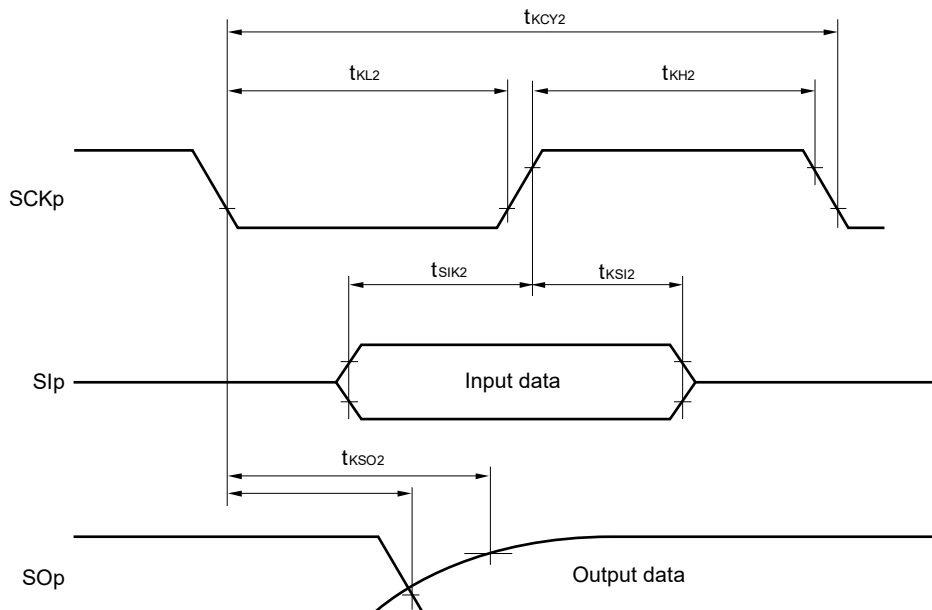

**Simplified SPI (CSI) mode serial transfer timing (slave mode) (during communication at different potential)
(When DAPmn = 0 and CKPmn = 1, or DAPmn = 1 and CKPmn = 0.)**



Remark p: CSI number (p = 00, 20), m: Unit number (m = 0, 1), n: Channel number (n = 0)

(10) Communication at different potential (1.8 V, 2.5 V, 3 V) (simplified I²C mode)**($T_A = -40$ to $+85^\circ\text{C}$, $1.8\text{ V} \leq V_{DD} \leq 5.5\text{ V}$, $V_{SS} = 0\text{ V}$)**

Parameter	Symbol	Conditions	HS (high-speed main) Mode		LS (low-speed main) Mode		Unit
			MIN.	MAX.	MIN.	MAX.	
SCLr clock frequency	f _{SCL}	$4.0\text{ V} \leq V_{DD} \leq 5.5\text{ V}$, $2.7\text{ V} \leq V_b \leq 4.0\text{ V}$, $C_b = 100\text{ pF}$, $R_b = 2.8\text{ k}\Omega$		400 ^{Note1}		300 ^{Note1}	kHz
		$2.7\text{ V} \leq V_{DD} < 4.0\text{ V}$, $2.3\text{ V} \leq V_b \leq 2.7\text{ V}$, $C_b = 100\text{ pF}$, $R_b = 2.7\text{ k}\Omega$		400 ^{Note1}		300 ^{Note1}	kHz
		$1.8\text{ V} \leq V_{DD} < 3.3\text{ V}$, $1.6\text{ V} \leq V_b \leq 2.0\text{ V}$, ^{Note2} $C_b = 100\text{ pF}$, $R_b = 5.5\text{ k}\Omega$		300 ^{Note1}		300 ^{Note1}	kHz
Hold time when SCLr = "L"	t _{LOW}	$4.0\text{ V} \leq V_{DD} \leq 5.5\text{ V}$, $2.7\text{ V} \leq V_b \leq 4.0\text{ V}$, $C_b = 100\text{ pF}$, $R_b = 2.8\text{ k}\Omega$	1150		1550		ns
		$2.7\text{ V} \leq V_{DD} < 4.0\text{ V}$, $2.3\text{ V} \leq V_b \leq 2.7\text{ V}$, $C_b = 100\text{ pF}$, $R_b = 2.7\text{ k}\Omega$	1150		1550		ns
		$1.8\text{ V} \leq V_{DD} < 3.3\text{ V}$, $1.6\text{ V} \leq V_b \leq 2.0\text{ V}$, ^{Note2} $C_b = 100\text{ pF}$, $R_b = 5.5\text{ k}\Omega$	1550		1550		ns
Hold time when SCLr = "H"	t _{HIGH}	$4.0\text{ V} \leq V_{DD} \leq 5.5\text{ V}$, $2.7\text{ V} \leq V_b \leq 4.0\text{ V}$, $C_b = 100\text{ pF}$, $R_b = 2.8\text{ k}\Omega$	675		610		ns
		$2.7\text{ V} \leq V_{DD} < 4.0\text{ V}$, $2.3\text{ V} \leq V_b \leq 2.7\text{ V}$, $C_b = 100\text{ pF}$, $R_b = 2.7\text{ k}\Omega$	600		610		ns
		$1.8\text{ V} \leq V_{DD} < 3.3\text{ V}$, $1.6\text{ V} \leq V_b \leq 2.0\text{ V}$, ^{Note2} $C_b = 100\text{ pF}$, $R_b = 5.5\text{ k}\Omega$	610		610		ns
Data setup time (reception)	t _{SU:DAT}	$4.0\text{ V} \leq V_{DD} \leq 5.5\text{ V}$, $2.7\text{ V} \leq V_b \leq 4.0\text{ V}$, $C_b = 100\text{ pF}$, $R_b = 2.8\text{ k}\Omega$	$1/f_{MCK}$ + 190 ^{Note3}		$1/f_{MCK}$ + 190 ^{Note3}		ns
		$2.7\text{ V} \leq V_{DD} < 4.0\text{ V}$, $2.3\text{ V} \leq V_b \leq 2.7\text{ V}$, $C_b = 100\text{ pF}$, $R_b = 2.7\text{ k}\Omega$	$1/f_{MCK}$ + 190 ^{Note3}		$1/f_{MCK}$ + 190 ^{Note3}		ns
		$1.8\text{ V} \leq V_{DD} < 3.3\text{ V}$, $1.6\text{ V} \leq V_b \leq 2.0\text{ V}$, ^{Note2} $C_b = 100\text{ pF}$, $R_b = 5.5\text{ k}\Omega$	$1/f_{MCK}$ + 190 ^{Note3}		$1/f_{MCK}$ + 190 ^{Note3}		ns
Data hold time (transmission)	t _{HD:DAT}	$4.0\text{ V} \leq V_{DD} \leq 5.5\text{ V}$, $2.7\text{ V} \leq V_b \leq 4.0\text{ V}$, $C_b = 100\text{ pF}$, $R_b = 2.8\text{ k}\Omega$	0	355	0	355	ns
		$2.7\text{ V} \leq V_{DD} < 4.0\text{ V}$, $2.3\text{ V} \leq V_b \leq 2.7\text{ V}$, $C_b = 100\text{ pF}$, $R_b = 2.7\text{ k}\Omega$	0	355	0	355	ns
		$1.8\text{ V} \leq V_{DD} < 3.3\text{ V}$, $1.6\text{ V} \leq V_b \leq 2.0\text{ V}$, ^{Note2} $C_b = 100\text{ pF}$, $R_b = 5.5\text{ k}\Omega$	0	405	0	405	ns

- Notes**
1. The value must be equal to or less than $f_{MCK}/4$.
 2. Use it with $V_{DD} \geq V_b$.
 3. Set t_{SU:DAT} so that it will not exceed the hold time when SCLr = "L" or SCLr = "H".

Cautions

1. Select the TTL input buffer and the N-ch open drain output (V_{DD} tolerance) mode for the SDAr pin and the N-ch open drain output (V_{DD} tolerance) mode for the SCLr pin by using port input mode register 1 (PIM1) and port output mode register 1 (POM1). For V_{IH} and V_{IL}, see the DC characteristics with TTL input buffer selected.

2. IIC01 and IIC11 cannot communicate at different potential.

(Remarks are listed on the next page.)

Simplified I²C mode connection diagram (during communication at different potential)



Simplified I²C mode serial transfer timing (during communication at different potential)



- Remarks 1.** R_b [Ω]: Communication line (SDAr, SCLr) pull-up resistance, C_b [F]: Communication line (SDAr, SCLr) load capacitance, V_b [V]: Communication line voltage
- 2.** r: IIC Number (r = 00, 20)
- 3.** f_{MCK} : Serial array unit operation clock frequency
(Operation clock to be set by the serial clock select register m (SPSm) and the CKSmn bit of serial mode register mn (SMRmn).
m: Unit number (m = 0,1), n: Channel number (n = 0))
- 4.** Simplified I²C mode is supported only by the R5F102 products.

2.5.2 Serial interface IICA

(T_A = -40 to +85°C, 1.8 V ≤ V_{DD} ≤ 5.5 V, V_{SS} = 0 V)

Parameter	Symbol	Conditions	HS (high-speed main) mode LS (low-speed main) mode				Unit
			Standard Mode		Fast Mode		
			MIN.	MAX.	MIN.	MAX.	
			SCLA0 clock frequency	f _{SCL}	Fast mode: f _{CLK} ≥ 3.5 MHz Normal mode: f _{CLK} ≥ 1 MHz		
Setup time of restart condition	t _{SU:STA}		4.7		0.6		μs
Hold time ^{Note 1}	t _{HD:STA}		4.0		0.6		μs
Hold time when SCLA0 = "L"	t _{LOW}		4.7		1.3		μs
Hold time when SCLA0 = "H"	t _{HIGH}		4.0		0.6		μs
Data setup time (reception)	t _{SU:DAT}		250		100		ns
Data hold time (transmission) ^{Note 2}	t _{HD:DAT}		0	3.45	0	0.9	μs
Setup time of stop condition	t _{SU:STO}		4.0		0.6		μs
Bus-free time	t _{BUF}		4.7		1.3		μs

- Notes**
- The first clock pulse is generated after this period when the start/restart condition is detected.
 - The maximum value (MAX.) of t_{HD:DAT} is during normal transfer and a clock stretch state is inserted in the ACK (acknowledge) timing.

Caution Only in the 30-pin products, the values in the above table are applied even when bit 2 (PIOR2) in the peripheral I/O redirection register (PIOR) is 1. At this time, the pin characteristics (I_{OH1}, I_{OL1}, V_{OH1}, V_{OL1}) must satisfy the values in the redirect destination.

Remark The maximum value of C_b (communication line capacitance) and the value of R_b (communication line pull-up resistor) at that time in each mode are as follows.

Normal mode: C_b = 400 pF, R_b = 2.7 kΩ
 Fast mode: C_b = 320 pF, R_b = 1.1 kΩ

IICA serial transfer timing

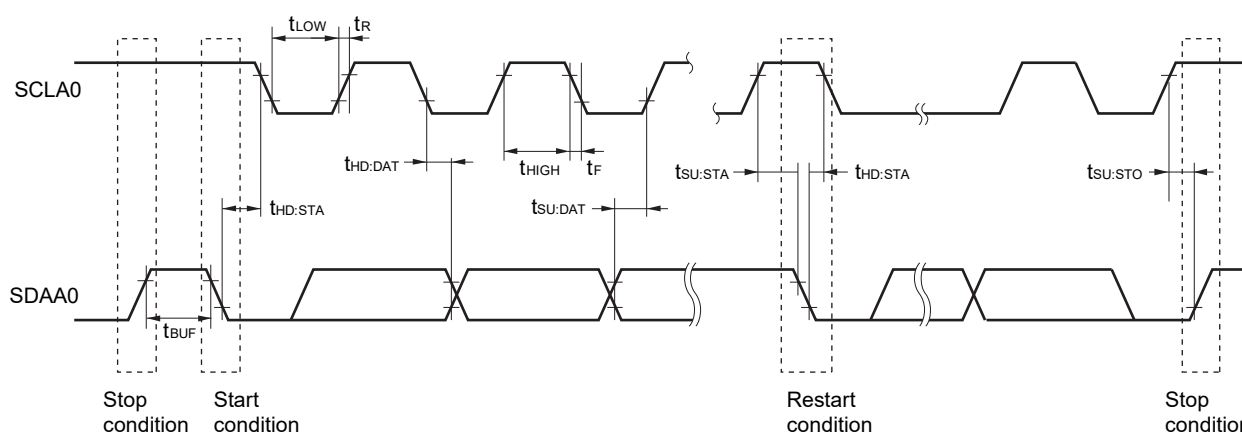

2.6 Analog Characteristics

2.6.1 A/D converter characteristics

Classification of A/D converter characteristics

Input channel	Reference Voltage		
	Reference voltage (+) = AV_{REFP} Reference voltage (-) = AV_{REFM}	Reference voltage (+) = V_{DD} Reference voltage (-) = V_{SS}	Reference voltage (+) = V_{BGR} Reference voltage (-) = AV_{REFM}
ANI0 to ANI3	Refer to 2.6.1 (1).	Refer to 2.6.1 (3).	Refer to 2.6.1 (4).
ANI16 to ANI22			
Internal reference voltage Temperature sensor output voltage	Refer to 2.6.1 (1).		–

(1) When reference voltage (+) = $AV_{REFP}/ANI0$ ($ADREFP1 = 0$, $ADREFP0 = 1$), reference voltage (-) = $AV_{REFM}/ANI1$ ($ADREFM = 1$), target pin: ANI2, ANI3, internal reference voltage, and temperature sensor output voltage

($T_A = -40$ to $+85^\circ\text{C}$, $1.8\text{ V} \leq AV_{REFP} \leq V_{DD} \leq 5.5\text{ V}$, $V_{SS} = 0\text{ V}$, Reference voltage (+) = AV_{REFP} , Reference voltage (-) = $AV_{REFM} = 0\text{ V}$)

Parameter	Symbol	Conditions	MIN.	TYP.	MAX.	Unit	
Resolution	RES		8		10	bit	
Overall error ^{Note 1}	AINL	10-bit resolution $AV_{REFP} = V_{DD}$ ^{Note 3}		1.2	± 3.5	LSB	
				1.2	± 7.0 ^{Note 4}	LSB	
Conversion time	t_{CONV}	10-bit resolution Target pin: ANI2, ANI3	$3.6\text{ V} \leq V_{DD} \leq 5.5\text{ V}$	2.125		39	μs
			$2.7\text{ V} \leq V_{DD} \leq 5.5\text{ V}$	3.1875		39	μs
			$1.8\text{ V} \leq V_{DD} \leq 5.5\text{ V}$	17		39	μs
		10-bit resolution Target pin: Internal reference voltage, and temperature sensor output voltage (HS (high-speed main) mode)	$3.6\text{ V} \leq V_{DD} \leq 5.5\text{ V}$	2.375		39	μs
			$2.7\text{ V} \leq V_{DD} \leq 5.5\text{ V}$	3.5625		39	μs
			$2.4\text{ V} \leq V_{DD} \leq 5.5\text{ V}$	17		39	μs
Zero-scale error ^{Notes 1, 2}	EZS	10-bit resolution $AV_{REFP} = V_{DD}$ ^{Note 3}			± 0.25	%FSR	
					± 0.50 ^{Note 4}	%FSR	
Full-scale error ^{Notes 1, 2}	EFS	10-bit resolution $AV_{REFP} = V_{DD}$ ^{Note 3}			± 0.25	%FSR	
					± 0.50 ^{Note 4}	%FSR	
Integral linearity error ^{Note 1}	ILE	10-bit resolution $AV_{REFP} = V_{DD}$ ^{Note 3}			± 2.5	LSB	
					± 5.0 ^{Note 4}	LSB	
Differential linearity error ^{Note 1}	DLE	10-bit resolution $AV_{REFP} = V_{DD}$ ^{Note 3}			± 1.5	LSB	
					± 2.0 ^{Note 4}	LSB	
Analog input voltage	V_{AIN}	ANI2, ANI3	0		AV_{REFP}	V	
		Internal reference voltage ($2.4\text{ V} \leq V_{DD} \leq 5.5\text{ V}$, HS (high-speed main) mode)			V_{BGR} ^{Note 5}	V	
		Temperature sensor output voltage ($2.4\text{ V} \leq V_{DD} \leq 5.5\text{ V}$, HS (high-speed main) mode)			V_{TMPS25} ^{Note 5}	V	

(Notes are listed on the next page.)

- Notes**
- Excludes quantization error ($\pm 1/2$ LSB).
 - This value is indicated as a ratio (%FSR) to the full-scale value.
 - When $AV_{REFP} < V_{DD}$, the MAX. values are as follows.
 Overall error: Add ± 1.0 LSB to the MAX. value when $AV_{REFP} = V_{DD}$.
 Zero-scale error/Full-scale error: Add $\pm 0.05\%$ FSR to the MAX. value when $AV_{REFP} = V_{DD}$.
 Integral linearity error/ Differential linearity error: Add ± 0.5 LSB to the MAX. value when $AV_{REFP} = V_{DD}$.
 - Values when the conversion time is set to 57 μs (min.) and 95 μs (max.).
 - Refer to **2.6.2 Temperature sensor/internal reference voltage characteristics**.

(2) When reference voltage (+) = $AV_{REFP}/ANI0$ (ADREFP1 = 0, ADREFP0 = 1), reference voltage (-) = $AV_{REFM}/ANI1$ (ADREFM = 1), target pin: ANI16 to ANI22

($T_A = -40$ to $+85^\circ\text{C}$, $1.8\text{ V} \leq AV_{REFP} \leq V_{DD} \leq 5.5\text{ V}$, $V_{SS} = 0\text{ V}$, Reference voltage (+) = AV_{REFP} , Reference voltage (-) = $AV_{REFM} = 0\text{ V}$)

Parameter	Symbol	Conditions		MIN.	TYP.	MAX.	Unit
Resolution	RES			8		10	bit
Overall error ^{Note 1}	AINL	10-bit resolution $AV_{REFP} = V_{DD}$ ^{Note 3}			1.2	± 5.0	LSB
					1.2	± 8.5 ^{Note 4}	LSB
Conversion time	t_{CONV}	10-bit resolution Target ANI pin: ANI16 to ANI22	$3.6\text{ V} \leq V_{DD} \leq 5.5\text{ V}$	2.125		39	μs
			$2.7\text{ V} \leq V_{DD} \leq 5.5\text{ V}$	3.1875		39	μs
			$1.8\text{ V} \leq V_{DD} \leq 5.5\text{ V}$	17		39	μs
				57		95	μs
Zero-scale error ^{Notes 1, 2}	EZS	10-bit resolution $AV_{REFP} = V_{DD}$ ^{Note 3}				± 0.35	%FSR
						± 0.60 ^{Note 4}	%FSR
Full-scale error ^{Notes 1, 2}	EFS	10-bit resolution $AV_{REFP} = V_{DD}$ ^{Note 3}				± 0.35	%FSR
						± 0.60 ^{Note 4}	%FSR
Integral linearity error ^{Note 1}	ILE	10-bit resolution $AV_{REFP} = V_{DD}$ ^{Note 3}				± 3.5	LSB
						± 6.0 ^{Note 4}	LSB
Differential linearity error ^{Note 1}	DLE	10-bit resolution $AV_{REFP} = V_{DD}$ ^{Note 3}				± 2.0	LSB
						± 2.5 ^{Note 4}	LSB
Analog input voltage	V_{AIN}	ANI16 to ANI22		0		AV_{REFP} and V_{DD}	V

- Notes**
- Excludes quantization error ($\pm 1/2$ LSB).
 - This value is indicated as a ratio (%FSR) to the full-scale value.
 - When $AV_{REFP} \leq V_{DD}$, the MAX. values are as follows.
 Overall error: Add ± 4.0 LSB to the MAX. value when $AV_{REFP} = V_{DD}$.
 Zero-scale error/Full-scale error: Add $\pm 0.20\%$ FSR to the MAX. value when $AV_{REFP} = V_{DD}$.
 Integral linearity error/ Differential linearity error: Add ± 2.0 LSB to the MAX. value when $AV_{REFP} = V_{DD}$.
 - When the conversion time is set to 57 μs (min.) and 95 μs (max.).

(3) When reference voltage (+) = V_{DD} (ADREFP1 = 0, ADREFP0 = 0), reference voltage (-) = V_{SS} (ADREFM = 0), target pin: ANI0 to ANI3, ANI16 to ANI22, internal reference voltage, and temperature sensor output voltage

($T_A = -40$ to $+85^\circ\text{C}$, $1.8\text{ V} \leq V_{DD} \leq 5.5\text{ V}$, $V_{SS} = 0\text{ V}$, Reference voltage (+) = V_{DD} , Reference voltage (-) = V_{SS})

Parameter	Symbol	Conditions	MIN.	TYP.	MAX.	Unit	
Resolution	R_{ES}		8		10	bit	
Overall error ^{Note 1}	AINL	10-bit resolution		1.2	± 7.0	LSB	
				1.2	± 10.5 ^{Note 3}	LSB	
Conversion time	t_{CONV}	10-bit resolution Target pin: ANI0 to ANI3, ANI16 to ANI22	$3.6\text{ V} \leq V_{DD} \leq 5.5\text{ V}$	2.125		39	μs
			$2.7\text{ V} \leq V_{DD} \leq 5.5\text{ V}$	3.1875		39	μs
			$1.8\text{ V} \leq V_{DD} \leq 5.5\text{ V}$	17		39	μs
				57		95	μs
Conversion time	t_{CONV}	10-bit resolution Target pin: internal reference voltage, and temperature sensor output voltage (HS (high-speed main) mode)	$3.6\text{ V} \leq V_{DD} \leq 5.5\text{ V}$	2.375		39	μs
			$2.7\text{ V} \leq V_{DD} \leq 5.5\text{ V}$	3.5625		39	μs
			$2.4\text{ V} \leq V_{DD} \leq 5.5\text{ V}$	17		39	μs
Zero-scale error ^{Notes 1, 2}	EZS	10-bit resolution			± 0.60	%FSR	
					± 0.85 ^{Note 3}	%FSR	
Full-scale error ^{Notes 1, 2}	EFS	10-bit resolution			± 0.60	%FSR	
					± 0.85 ^{Note 3}	%FSR	
Integral linearity error ^{Note 1}	ILE	10-bit resolution			± 4.0	LSB	
					± 6.5 ^{Note 3}	LSB	
Differential linearity error ^{Note 1}	DLE	10-bit resolution			± 2.0	LSB	
					± 2.5 ^{Note 3}	LSB	
Analog input voltage	V_{AIN}	ANI0 to ANI3, ANI16 to ANI22	0		V_{DD}	V	
		Internal reference voltage ($2.4\text{ V} \leq V_{DD} \leq 5.5\text{ V}$, HS (high-speed main) mode)	V_{BGR} ^{Note 4}			V	
		Temperature sensor output voltage ($2.4\text{ V} \leq V_{DD} \leq 5.5\text{ V}$, HS (high-speed main) mode)	V_{TMPS25} ^{Note 4}			V	

Notes 1. Excludes quantization error ($\pm 1/2$ LSB).

2. This value is indicated as a ratio (%FSR) to the full-scale value.

3. When the conversion time is set to 57 μs (min.) and 95 μs (max.).

4. Refer to **2.6.2 Temperature sensor/internal reference voltage characteristics**.

(4) When reference voltage (+) = Internal reference voltage (ADREFP1 = 1, ADREFP0 = 0), reference voltage (-) = AV_{REFM} (ADREFM = 1), target pin: ANI0, ANI2, ANI3, and ANI16 to ANI22

($T_A = -40$ to $+85^\circ\text{C}$, $2.4\text{ V} \leq V_{DD} \leq 5.5\text{ V}$, $V_{SS} = 0\text{ V}$, Reference voltage (+) = V_{BGR} ^{Note 3}, Reference voltage (-) = AV_{REFM}

Note 4= 0 V, HS (high-speed main) mode)

Parameter	Symbol	Conditions	MIN.	TYP.	MAX.	Unit
Resolution	R_{ES}		8			bit
Conversion time	t_{CONV}	8-bit resolution	17		39	μs
Zero-scale error ^{Notes 1, 2}	EZS	8-bit resolution			± 0.60	%FSR
Integral linearity error ^{Note 1}	ILE	8-bit resolution			± 2.0	LSB
Differential linearity error ^{Note 1}	DLE	8-bit resolution			± 1.0	LSB
Analog input voltage	V_{AIN}		0		V_{BGR} ^{Note 3}	V

Notes 1. Excludes quantization error ($\pm 1/2$ LSB).

2. This value is indicated as a ratio (%FSR) to the full-scale value.

3. Refer to **2.6.2 Temperature sensor/internal reference voltage characteristics**.

4. When reference voltage (-) = V_{SS} , the MAX. values are as follows.

Zero-scale error: Add $\pm 0.35\%$ FSR to the MAX. value when reference voltage (-) = AV_{REFM} .

Integral linearity error: Add ± 0.5 LSB to the MAX. value when reference voltage (-) = AV_{REFM} .

Differential linearity error: Add ± 0.2 LSB to the MAX. value when reference voltage (-) = AV_{REFM} .

2.6.2 Temperature sensor/internal reference voltage characteristics

($T_A = -40$ to $+85^\circ\text{C}$, $2.4\text{ V} \leq V_{DD} \leq 5.5\text{ V}$, $V_{SS} = 0\text{ V}$, HS (high-speed main) mode)

Parameter	Symbol	Conditions	MIN.	TYP.	MAX.	Unit
Temperature sensor output voltage	V_{TMPS25}	Setting ADS register = 80H, $T_A = +25^\circ\text{C}$		1.05		V
Internal reference voltage	V_{BGR}	Setting ADS register = 81H	1.38	1.45	1.50	V
Temperature coefficient	F_{VTMPS}	Temperature sensor output voltage that depends on the temperature		-3.6		mV/ $^\circ\text{C}$
Operation stabilization wait time	t_{AMP}		5			μs

2.6.3 POR circuit characteristics

($T_A = -40$ to $+85^\circ\text{C}$, $V_{SS} = 0\text{ V}$)

Parameter	Symbol	Conditions	MIN.	TYP.	MAX.	Unit
Detection voltage	V_{POR}	The power supply voltage is rising.	1.47	1.51	1.55	V
	V_{PDR}	The power supply voltage is falling.	1.46	1.50	1.54	V
Minimum pulse width ^{Note}	T_{PW}		300			μs

Note Minimum time required for a POR reset when V_{DD} exceeds below V_{PDR} . This is also the minimum time required for a POR reset from when V_{DD} exceeds below 0.7 V to when V_{DD} exceeds V_{POR} while STOP mode is entered or the main system clock is stopped through setting bit 0 (HIOSTOP) and bit 7 (MSTOP) in the clock operation status control register (CSC).

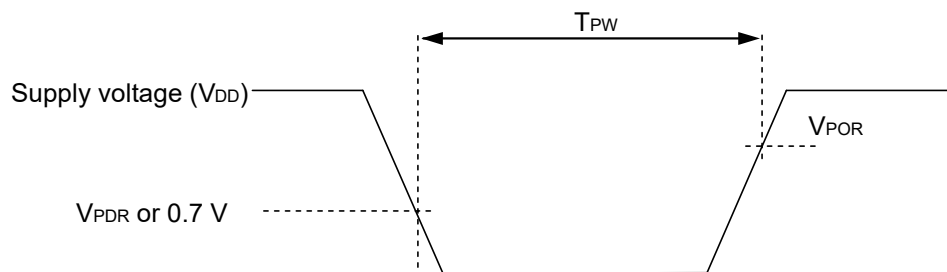

2.6.4 LVD circuit characteristics

LVD Detection Voltage of Reset Mode and Interrupt Mode

($T_A = -40$ to $+85^\circ\text{C}$, $V_{PDR} \leq V_{DD} \leq 5.5$ V, $V_{SS} = 0$ V)

Parameter	Symbol	Conditions	MIN.	TYP.	MAX.	Unit
Detection supply voltage	V _{LVD0}	The power supply voltage is rising.	3.98	4.06	4.14	V
		The power supply voltage is falling.	3.90	3.98	4.06	V
	V _{LVD1}	The power supply voltage is rising.	3.68	3.75	3.82	V
		The power supply voltage is falling.	3.60	3.67	3.74	V
	V _{LVD2}	The power supply voltage is rising.	3.07	3.13	3.19	V
		The power supply voltage is falling.	3.00	3.06	3.12	V
	V _{LVD3}	The power supply voltage is rising.	2.96	3.02	3.08	V
		The power supply voltage is falling.	2.90	2.96	3.02	V
	V _{LVD4}	The power supply voltage is rising.	2.86	2.92	2.97	V
		The power supply voltage is falling.	2.80	2.86	2.91	V
	V _{LVD5}	The power supply voltage is rising.	2.76	2.81	2.87	V
		The power supply voltage is falling.	2.70	2.75	2.81	V
	V _{LVD6}	The power supply voltage is rising.	2.66	2.71	2.76	V
		The power supply voltage is falling.	2.60	2.65	2.70	V
	V _{LVD7}	The power supply voltage is rising.	2.56	2.61	2.66	V
		The power supply voltage is falling.	2.50	2.55	2.60	V
	V _{LVD8}	The power supply voltage is rising.	2.45	2.50	2.55	V
		The power supply voltage is falling.	2.40	2.45	2.50	V
	V _{LVD9}	The power supply voltage is rising.	2.05	2.09	2.13	V
		The power supply voltage is falling.	2.00	2.04	2.08	V
	V _{LVD10}	The power supply voltage is rising.	1.94	1.98	2.02	V
		The power supply voltage is falling.	1.90	1.94	1.98	V
V _{LVD11}	The power supply voltage is rising.	1.84	1.88	1.91	V	
	The power supply voltage is falling.	1.80	1.84	1.87	V	
Minimum pulse width	t _{LW}		300			μs
Detection delay time					300	μs

LVD detection voltage of interrupt & reset mode**($T_A = -40$ to $+85^\circ\text{C}$, $V_{PDR} \leq V_{DD} \leq 5.5$ V, $V_{SS} = 0$ V)**

Parameter	Symbol	Conditions	MIN.	TYP.	MAX.	Unit	
Interrupt and reset mode	VLVDB0	$V_{POC2}, V_{POC1}, V_{POC0} = 0, 0, 1$, falling reset voltage	1.80	1.84	1.87	V	
	VLVDB1	LVIS1, LVIS0 = 1, 0	Rising reset release voltage	1.94	1.98	2.02	V
			Falling interrupt voltage	1.90	1.94	1.98	V
	VLVDB2	LVIS1, LVIS0 = 0, 1	Rising reset release voltage	2.05	2.09	2.13	V
			Falling interrupt voltage	2.00	2.04	2.08	V
	VLVDB3	LVIS1, LVIS0 = 0, 0	Rising reset release voltage	3.07	3.13	3.19	V
			Falling interrupt voltage	3.00	3.06	3.12	V
	VLVDC0	$V_{POC2}, V_{POC1}, V_{POC0} = 0, 1, 0$, falling reset voltage	2.40	2.45	2.50	V	
	VLVDC1	LVIS1, LVIS0 = 1, 0	Rising reset release voltage	2.56	2.61	2.66	V
			Falling interrupt voltage	2.50	2.55	2.60	V
	VLVDC2	LVIS1, LVIS0 = 0, 1	Rising reset release voltage	2.66	2.71	2.76	V
			Falling interrupt voltage	2.60	2.65	2.70	V
	VLVDC3	LVIS1, LVIS0 = 0, 0	Rising reset release voltage	3.68	3.75	3.82	V
			Falling interrupt voltage	3.60	3.67	3.74	V
	VLVDD0	$V_{POC2}, V_{POC1}, V_{POC0} = 0, 1, 1$, falling reset voltage	2.70	2.75	2.81	V	
	VLVDD1	LVIS1, LVIS0 = 1, 0	Rising reset release voltage	2.86	2.92	2.97	V
			Falling interrupt voltage	2.80	2.86	2.91	V
	VLVDD2	LVIS1, LVIS0 = 0, 1	Rising reset release voltage	2.96	3.02	3.08	V
			Falling interrupt voltage	2.90	2.96	3.02	V
	VLVDD3	LVIS1, LVIS0 = 0, 0	Rising reset release voltage	3.98	4.06	4.14	V
Falling interrupt voltage			3.90	3.98	4.06	V	

2.6.5 Power supply voltage rising slope characteristics**($T_A = -40$ to $+85^\circ\text{C}$, $V_{SS} = 0$ V)**

Parameter	Symbol	Conditions	MIN.	TYP.	MAX.	Unit
Power supply voltage rising slope	S_{VDD}				54	V/ms

Caution Make sure to keep the internal reset state by the LVD circuit or an external reset until V_{DD} reaches the operating voltage range shown in 2.4 AC Characteristics.

2.7 RAM Data Retention Characteristics

(T_A = -40 to +85°C, V_{SS} = 0 V)

Parameter	Symbol	Conditions	MIN.	TYP.	MAX.	Unit
Data retention supply voltage	V _{DDDR}		1.46 ^{Note}		5.5	V

Note This depends on the POR detection voltage. For a falling voltage, data in RAM are retained until the voltage reaches the level that triggers a POR reset but not once it reaches the level at which a POR reset is generated.



2.8 Flash Memory Programming Characteristics

(T_A = -40 to +85°C, 1.8 V ≤ V_{DD} ≤ 5.5 V, V_{SS} = 0 V)

Parameter	Symbol	Conditions	MIN.	TYP.	MAX.	Unit
System clock frequency	f _{CLK}		1		24	MHz
Code flash memory rewritable times <small>Notes 1, 2, 3</small>	C _{erwr}	Retained for 20 years T _A = 85°C	1,000			Times
Data flash memory rewritable times <small>Notes 1, 2, 3</small>		Retained for 1 year T _A = 25°C		1,000,000		
		Retained for 5 years T _A = 85°C	100,000			
		Retained for 20 years T _A = 85°C	10,000			

- Notes**
- 1 erase + 1 write after the erase is regarded as 1 rewrite. The retaining years are until next rewrite after the rewrite.
 2. When using flash memory programmer and Renesas Electronics self programming library
 3. These are the characteristics of the flash memory and the results obtained from reliability testing by Renesas Electronics Corporation.

2.9 Dedicated Flash Memory Programmer Communication (UART)

(T_A = -40 to +85°C, 1.8 V ≤ V_{DD} ≤ 5.5 V, V_{SS} = 0 V)

Parameter	Symbol	Conditions	MIN.	TYP.	MAX.	Unit
Transfer rate		During serial programming	115,200		1,000,000	bps

2.10 Timing of Entry to Flash Memory Programming Modes

(T_A = -40 to +85°C, 1.8 V ≤ V_{DD} ≤ 5.5 V, V_{SS} = 0 V)

Parameter	Symbol	Conditions	MIN.	TYP.	MAX.	Unit
Time to complete the communication for the initial setting after the external reset is released	t _{SUINIT}	POR and LVD reset are released before external reset release			100	ms
Time to release the external reset after the TOOL0 pin is set to the low level	t _{SU}	POR and LVD reset are released before external reset release	10			μs
Time to hold the TOOL0 pin at the low level after the external reset is released (excluding the processing time of the firmware to control the flash memory)	t _{HD}	POR and LVD reset are released before external reset release	1			ms



- <1> The low level is input to the TOOL0 pin.
- <2> The external reset is released (POR and LVD reset must be released before the external reset is released.).
- <3> The TOOL0 pin is set to the high level.
- <4> Setting of the flash memory programming mode by UART reception and complete the baud rate setting.

Remark t_{SUINIT}: Communication for the initial setting must be completed within 100 ms after the external reset is released during this period.

t_{SU}: Time to release the external reset after the TOOL0 pin is set to the low level

t_{HD}: Time to hold the TOOL0 pin at the low level after the external reset is released (excluding the processing time of the firmware to control the flash memory)

3. ELECTRICAL SPECIFICATIONS (G: INDUSTRIAL APPLICATIONS $T_A = -40$ to $+105^\circ\text{C}$)

This chapter describes the following electrical specifications.

Target products G: Industrial applications $T_A = -40$ to $+105^\circ\text{C}$
R5F102xxGxx

- Cautions**
1. The RL78 microcontrollers have an on-chip debug function, which is provided for development and evaluation. Do not use the on-chip debug function in products designated for mass production, because the guaranteed number of rewritable times of the flash memory may be exceeded when this function is used, and product reliability therefore cannot be guaranteed. Renesas Electronics is not liable for problems occurring when the on-chip debug function is used.
 2. The pins mounted depend on the product. Refer to 2.1 Port Functions to 2.2.1 Functions for each product in the RL78/G12 User's Manual.
 3. Please contact Renesas Electronics sales office for derating of operation under $T_A = +85^\circ\text{C}$ to $+105^\circ\text{C}$. Derating is the systematic reduction of load for the sake of improved reliability.

Remark When the RL78 microcontroller is used in the range of $T_A = -40$ to $+85^\circ\text{C}$, see **2. ELECTRICAL SPECIFICATIONS ($T_A = -40$ to $+85^\circ\text{C}$)**.

There are following differences between the products "G: Industrial applications ($T_A = -40$ to $+105^\circ\text{C}$)" and the products "A: Consumer applications, and D: Industrial applications".

Parameter	Application	
	A: Consumer applications, D: Industrial applications	G: Industrial applications
Operating ambient temperature	$T_A = -40$ to $+85^\circ\text{C}$	$T_A = -40$ to $+105^\circ\text{C}$
Operating mode Operating voltage range	HS (high-speed main) mode: $2.7\text{ V} \leq V_{DD} \leq 5.5\text{ V}@1\text{ MHz}$ to 24 MHz $2.4\text{ V} \leq V_{DD} \leq 5.5\text{ V}@1\text{ MHz}$ to 16 MHz LS (low-speed main) mode: $1.8\text{ V} \leq V_{DD} \leq 5.5\text{ V}@1\text{ MHz}$ to 8 MHz	HS (high-speed main) mode only: $2.7\text{ V} \leq V_{DD} \leq 5.5\text{ V}@1\text{ MHz}$ to 24 MHz $2.4\text{ V} \leq V_{DD} \leq 5.5\text{ V}@1\text{ MHz}$ to 16 MHz
High-speed on-chip oscillator clock accuracy	R5F102 products, $1.8\text{ V} \leq V_{DD} \leq 5.5\text{ V}$: $\pm 1.0\%@T_A = -20$ to $+85^\circ\text{C}$ $\pm 1.5\%@T_A = -40$ to -20°C R5F103 products, $1.8\text{ V} \leq V_{DD} \leq 5.5\text{ V}$: $\pm 5.0\%@T_A = -40$ to $+85^\circ\text{C}$	R5F102 products, $2.4\text{ V} \leq V_{DD} \leq 5.5\text{ V}$: $\pm 2.0\%@T_A = +85$ to $+105^\circ\text{C}$ $\pm 1.0\%@T_A = -20$ to $+85^\circ\text{C}$ $\pm 1.5\%@T_A = -40$ to -20°C
Serial array unit	UART Simplified SPI (CSI): $f_{CLK}/2$ (supporting 12 Mbps), $f_{CLK}/4$ Simplified I ² C communication	UART Simplified SPI (CSI): $f_{CLK}/4$ Simplified I ² C communication
Voltage detector	Rise detection voltage: 1.88 V to 4.06 V (12 levels) Fall detection voltage: 1.84 V to 3.98 V (12 levels)	Rise detection voltage: 2.61 V to 4.06 V (8 levels) Fall detection voltage: 2.55 V to 3.98 V (8 levels)

Remark The electrical characteristics of the products G: Industrial applications ($T_A = -40$ to $+105^\circ\text{C}$) are different from those of the products "A: Consumer applications, and D: Industrial applications". For details, refer to **3.1 to 3.10**.

3.1 Absolute Maximum Ratings

Absolute Maximum Ratings ($T_A = 25^\circ\text{C}$)

Parameter	Symbols	Conditions		Ratings	Unit
Supply Voltage	V_{DD}			-0.5 to $+6.5$	V
REGC terminal input voltage ^{Note 1}	V_{IREGC}	REGC		-0.3 to $+2.8$ and -0.3 to $V_{DD} + 0.3$ <small>Note 2</small>	V
Input Voltage	V_{I1}	Other than P60, P61		-0.3 to $V_{DD} + 0.3$ ^{Note 3}	V
	V_{I2}	P60, P61 (N-ch open drain)		-0.3 to 6.5	V
Output Voltage	V_O			-0.3 to $V_{DD} + 0.3$ ^{Note 3}	V
Analog input voltage	V_{AI}	20-, 24-pin products: ANI0 to ANI3, ANI16 to ANI22 30-pin products: ANI0 to ANI3, ANI16 to ANI19		-0.3 to $V_{DD} + 0.3$ and -0.3 to $AV_{REF}(+) + 0.3$ ^{Notes 3, 4}	V
Output current, high	I_{OH1}	Per pin	Other than P20 to P23	-40	mA
		Total of all pins	All the terminals other than P20 to P23	-170	mA
			20-, 24-pin products: P40 to P42 30-pin products: P00, P01, P40, P120	-70	mA
			20-, 24-pin products: P00 to P03 ^{Note 5} , P10 to P14 30-pin products: P10 to P17, P30, P31, P50, P51, P147	-100	mA
	I_{OH2}	Per pin	P20 to P23	-0.5	mA
		Total of all pins		-2	mA
Output current, low	I_{OL1}	Per pin	Other than P20 to P23	40	mA
		Total of all pins	All the terminals other than P20 to P23	170	mA
			20-, 24-pin products: P40 to P42 30-pin products: P00, P01, P40, P120	70	mA
			20-, 24-pin products: P00 to P03 ^{Note 5} , P10 to P14, P60, P61 30-pin products: P10 to P17, P30, P31, P50, P51, P60, P61, P147	100	mA
	I_{OL2}	Per pin	P20 to P23	1	mA
		Total of all pins		5	mA
Operating ambient temperature	T_A			-40 to $+105$	$^\circ\text{C}$
Storage temperature	T_{stg}			-65 to $+150$	$^\circ\text{C}$

Notes 1. 30-pin product only.

2. Connect the REGC pin to V_{SS} via a capacitor (0.47 to 1 μF). This value determines the absolute maximum rating of the REGC pin. Do not use it with voltage applied.
3. Must be 6.5 V or lower.
4. Do not exceed $AV_{REF}(+) + 0.3$ V in case of A/D conversion target pin.
5. 24-pin products only.

Caution Product quality may suffer if the absolute maximum rating is exceeded even momentarily for any parameter. That is, the absolute maximum ratings are rated values at which the product is on the verge of suffering physical damage, and therefore the product must be used under conditions that ensure that the absolute maximum ratings are not exceeded.

- Remarks** 1. Unless specified otherwise, the characteristics of alternate-function pins are the same as those of the port pins.
2. $AV_{REF}(+)$: + side reference voltage of the A/D converter.
 3. V_{SS} : Reference voltage

3.2 Oscillator Characteristics

3.2.1 X1 oscillator characteristics

($T_A = -40$ to $+105^\circ\text{C}$, $2.4\text{ V} \leq V_{DD} \leq 5.5\text{ V}$, $V_{SS} = 0\text{ V}$)

Parameter	Resonator	Conditions	MIN.	TYP.	MAX.	Unit
X1 clock oscillation frequency (f_x) ^{Note}	Ceramic resonator / crystal oscillator	$2.7\text{ V} \leq V_{DD} \leq 5.5\text{ V}$	1.0		20.0	MHz
		$2.4\text{ V} \leq V_{DD} < 2.7\text{ V}$	1.0		8.0	

Note Indicates only permissible oscillator frequency ranges. Refer to AC Characteristics for instruction execution time. Request evaluation by the manufacturer of the oscillator circuit mounted on a board to check the oscillator characteristics.

Caution Since the CPU is started by the high-speed on-chip oscillator clock after a reset release, check the X1 clock oscillation stabilization time using the oscillation stabilization time counter status register (OSTC) by the user. Determine the oscillation stabilization time of the OSTC register and the oscillation stabilization time select register (OSTS) after sufficiently evaluating the oscillation stabilization time with the resonator to be used.

Remark When using the X1 oscillator, refer to **5.4 System Clock Oscillator** in the RL78/G12 User's Manual.

3.2.2 On-chip oscillator characteristics

($T_A = -40$ to $+105^\circ\text{C}$, $2.4\text{ V} \leq V_{DD} \leq 5.5\text{ V}$, $V_{SS} = 0\text{ V}$)

Oscillators	Parameters	Conditions	MIN.	TYP.	MAX.	Unit	
High-speed on-chip oscillator clock frequency ^{Notes 1, 2}	f_{IH}		1		24	MHz	
High-speed on-chip oscillator clock frequency accuracy		R5F102 products	$T_A = -20$ to $+85^\circ\text{C}$	-1.0		+1.0	%
			$T_A = -40$ to -20°C	-1.5		+1.5	%
			$T_A = +85$ to $+105^\circ\text{C}$	-2.0		+2.0	%
Low-speed on-chip oscillator clock frequency	f_{IL}			15		kHz	
Low-speed on-chip oscillator clock frequency accuracy			-15		+15	%	

Notes 1. High-speed on-chip oscillator frequency is selected by bits 0 to 3 of option byte (000C2H) and bits 0 to 2 of HOCODIV register.

2. This only indicates the oscillator characteristics. Refer to AC Characteristics for instruction execution time.

3.3 DC Characteristics

3.3.1 Pin characteristics

(T_A = -40 to +105°C, 2.4 V ≤ V_{DD} ≤ 5.5 V, V_{SS} = 0 V)

(1/4)

Parameter	Symbol	Conditions	MIN.	TYP.	MAX.	Unit		
Output current, high ^{Note 1}	I _{OH1}	20-, 24-pin products: Per pin for P00 to P03 ^{Note 4} , P10 to P14, P40 to P42 30-pin products: Per pin for P00, P01, P10 to P17, P30, P31, P40, P50, P51, P120, P147			-3.0 ^{Note 2}	mA		
		20-, 24-pin products: Total of P40 to P42 30-pin products: Total of P00, P01, P40, P120 (When duty ≤ 70% ^{Note 3})	4.0 V ≤ V _{DD} ≤ 5.5 V			-9.0	mA	
			2.7 V ≤ V _{DD} < 4.0 V			-6.0	mA	
			2.4 V ≤ V _{DD} < 2.7 V			-4.5	mA	
		20-, 24-pin products: Total of P00 to P03 ^{Note 4} , P10 to P14 30-pin products: Total of P10 to P17, P30, P31, P50, P51, P147 (When duty ≤ 70% ^{Note 3}) Total of all pins (When duty ≤ 70% ^{Note 3})	4.0 V ≤ V _{DD} ≤ 5.5 V			-27.0	mA	
			2.7 V ≤ V _{DD} < 4.0 V			-18.0	mA	
			2.4 V ≤ V _{DD} < 2.7 V			-10.0	mA	
						-36.0	mA	
		I _{OH2}	Per pin for P20 to P23				-0.1	mA
			Total of all pins				-0.4	mA

- Notes**
- value of current at which the device operation is guaranteed even if the current flows from the V_{DD} pin to an output pin.
 - However, do not exceed the total current value.
 - The output current value under conditions where the duty factor ≤ 70%.
If duty factor > 70%: The output current value can be calculated with the following expression (where n represents the duty factor as a percentage).
 - Total output current of pins = (I_{OH} × 0.7)/(n × 0.01)
<Example> Where n = 80% and I_{OH} = -10.0 mA
Total output current of pins = (-10.0 × 0.7)/(80 × 0.01) ≅ -8.7 mA
 However, the current that is allowed to flow into one pin does not vary depending on the duty factor. A current higher than the absolute maximum rating must not flow into one pin.
 - 24-pin products only.

Caution P10 to P12 and P41 for 20-pin products, P01, P10 to P12, and P41 for 24-pin products, and P00, P10 to P15, P17, and P50 for 30-pin products do not output high level in N-ch open-drain mode.

Remark Unless specified otherwise, the characteristics of alternate-function pins are the same as those of the port pins.

(T_A = -40 to +105°C, 2.4 V ≤ V_{DD} ≤ 5.5 V, V_{SS} = 0 V)

(2/4)

Parameter	Symbol	Conditions	MIN.	TYP.	MAX.	Unit
Output current, low ^{Note 1}	I _{OL1}	20-, 24-pin products: Per pin for P00 to P03 ^{Note 4} , P10 to P14, P40 to P42 30-pin products: Per pin for P00, P01, P10 to P17, P30, P31, P40, P50, P51, P120, P147			8.5 ^{Note 2}	mA
		Per pin for P60, P61			15.0 ^{Note 2}	mA
		20-, 24-pin products: Total of P40 to P42 30-pin products: Total of P00, P01, P40, P120 (When duty ≤ 70% ^{Note 3})	4.0 V ≤ V _{DD} ≤ 5.5 V		25.5	mA
			2.7 V ≤ V _{DD} < 4.0 V		9.0	mA
			2.4 V ≤ V _{DD} < 2.7 V		1.8	mA
		20-, 24-pin products: Total of P00 to P03 ^{Note 4} , P10 to P14, P60, P61 30-pin products: Total of P10 to P17, P30, P31, P50, P51, P60, P61, P147 (When duty ≤ 70% ^{Note 3})	4.0 V ≤ V _{DD} ≤ 5.5 V		40.0	mA
			2.7 V ≤ V _{DD} < 4.0 V		27.0	mA
			2.4 V ≤ V _{DD} < 2.7 V		5.4	mA
		Total of all pins (When duty ≤ 70% ^{Note 3})			65.5	mA
		I _{OL2}	Per pin for P20 to P23			0.4
Total of all pins				1.6	mA	

Notes 1. Value of current at which the device operation is guaranteed even if the current flows from an output pin to the V_{SS} pin.

2. However, do not exceed the total current value.

3. The output current value under conditions where the duty factor ≤ 70%.

If duty factor > 70%: The output current value can be calculated with the following expression (where n represents the duty factor as a percentage).

- Total output current of pins = (I_{OL} × 0.7)/(n × 0.01)

<Example> Where n = 80% and I_{OL} = 10.0 mA

$$\text{Total output current of pins} = (10.0 \times 0.7)/(80 \times 0.01) \cong 8.7 \text{ mA}$$

However, the current that is allowed to flow into one pin does not vary depending on the duty factor. A current higher than the absolute maximum rating must not flow into one pin.

4. 24-pin products only.

Remark Unless specified otherwise, the characteristics of alternate-function pins are the same as those of the port pins.

($T_A = -40$ to $+105^\circ\text{C}$, $2.4\text{ V} \leq V_{DD} \leq 5.5\text{ V}$, $V_{SS} = 0\text{ V}$)**(3/4)**

Parameter	Symbol	Conditions	MIN.	TYP.	MAX.	Unit
Input voltage, high	V_{IH1}	Normal input buffer 20-, 24-pin products: P00 to P03 ^{Note 2} , P10 to P14, P40 to P42 30-pin products: P00, P01, P10 to P17, P30, P31, P40, P50, P51, P120, P147	$0.8V_{DD}$		V_{DD}	V
	V_{IH2}	TTL input buffer 20-, 24-pin products: P10, P11 30-pin products: P01, P10, P11, P13 to P17	$4.0\text{ V} \leq V_{DD} \leq 5.5\text{ V}$	2.2	V_{DD}	V
			$3.3\text{ V} \leq V_{DD} < 4.0\text{ V}$	2.0	V_{DD}	V
			$2.4\text{ V} \leq V_{DD} < 3.3\text{ V}$	1.5	V_{DD}	V
	V_{IH3}	Normal input buffer P20 to P23	$0.7V_{DD}$		V_{DD}	V
	V_{IH4}	P60, P61	$0.7V_{DD}$		6.0	V
V_{IH5}	P121, P122, P125 ^{Note 1} , P137, EXCLK, RESET	$0.8V_{DD}$		V_{DD}	V	
Input voltage, low	V_{IL1}	Normal input buffer 20-, 24-pin products: P00 to P03 ^{Note 2} , P10 to P14, P40 to P42 30-pin products: P00, P01, P10 to P17, P30, P31, P40, P50, P51, P120, P147	0		$0.2V_{DD}$	V
	V_{IL2}	TTL input buffer 20-, 24-pin products: P10, P11 30-pin products: P01, P10, P11, P13 to P17	$4.0\text{ V} \leq V_{DD} \leq 5.5\text{ V}$	0	0.8	V
			$3.3\text{ V} \leq V_{DD} < 4.0\text{ V}$	0	0.5	V
			$2.4\text{ V} \leq V_{DD} < 3.3\text{ V}$	0	0.32	V
	V_{IL3}	P20 to P23	0		$0.3V_{DD}$	V
	V_{IL4}	P60, P61	0		$0.3V_{DD}$	V
V_{IL5}	P121, P122, P125 ^{Note 1} , P137, EXCLK, RESET	0		$0.2V_{DD}$	V	
Output voltage, high	V_{OH1}	20-, 24-pin products: P00 to P03 ^{Note 2} , P10 to P14, P40 to P42 30-pin products: P00, P01, P10 to P17, P30, P31, P40, P50, P51, P120, P147	$4.0\text{ V} \leq V_{DD} \leq 5.5\text{ V}$, $I_{OH1} = -3.0\text{ mA}$	$V_{DD}-0.7$		V
			$2.7\text{ V} \leq V_{DD} \leq 5.5\text{ V}$, $I_{OH1} = -2.0\text{ mA}$	$V_{DD}-0.6$		V
			$2.4\text{ V} \leq V_{DD} \leq 5.5\text{ V}$, $I_{OH1} = -1.5\text{ mA}$	$V_{DD}-0.5$		V
	V_{OH2}	P20 to P23	$I_{OH2} = -100\text{ }\mu\text{A}$	$V_{DD}-0.5$		V

Notes 1. 20, 24-pin products only.

2. 24-pin products only.

Caution The maximum value of V_{IH} of pins P10 to P12 and P41 for 20-pin products, P01, P10 to P12, and P41 for 24-pin products, and P00, P10 to P15, P17, and P50 for 30-pin products is V_{DD} even in N-ch open-drain mode.

High level is not output in the N-ch open-drain mode.

Remark Unless specified otherwise, the characteristics of alternate-function pins are the same as those of the port pins.

($T_A = -40$ to $+105^\circ\text{C}$, $2.4\text{ V} \leq V_{DD} \leq 5.5\text{ V}$, $V_{SS} = 0\text{ V}$)**(4/4)**

Parameter	Symbol	Conditions		MIN.	TYP.	MAX.	Unit
Output voltage, low	V _{OL1}	20-, 24-pin products: P00 to P03 ^{Note} , P10 to P14, P40 to P42	4.0 V \leq V _{DD} \leq 5.5 V, I _{OL1} = 8.5 mA			0.7	V
			2.7 V \leq V _{DD} \leq 5.5 V, I _{OL1} = 3.0 mA			0.6	V
		30-pin products: P00, P01, P10 to P17, P30, P31, P40, P50, P51, P120, P147	2.7 V \leq V _{DD} \leq 5.5 V, I _{OL1} = 1.5 mA			0.4	V
			2.4 V \leq V _{DD} \leq 5.5 V, I _{OL1} = 0.6 mA			0.4	V
	V _{OL2}	P20 to P23	I _{OL2} = 400 μ A			0.4	V
	V _{OL3}	P60, P61	4.0 V \leq V _{DD} \leq 5.5 V, I _{OL1} = 15.0 mA			2.0	V
			4.0 V \leq V _{DD} \leq 5.5 V, I _{OL1} = 5.0 mA			0.4	V
			2.7 V \leq V _{DD} \leq 5.5 V, I _{OL1} = 3.0 mA			0.4	V
2.4 V \leq V _{DD} \leq 5.5 V, I _{OL1} = 2.0 mA					0.4	V	
Input leakage current, high	I _{LIH1}	Other than P121, P122	V _I = V _{DD}			1	μ A
	I _{LIH2}	P121, P122 (X1, X2/EXCLK)	V _I = V _{DD}	Input port or external clock input		1	μ A
				When resonator connected		10	μ A
Input leakage current, low	I _{LIL1}	Other than P121, P122	V _I = V _{SS}			-1	μ A
	I _{LIL2}	P121, P122 (X1, X2/EXCLK)	V _I = V _{SS}	Input port or external clock input		-1	μ A
When resonator connected					-10	μ A	
On-chip pull-up resistance	R _U	20-, 24-pin products: P00 to P03 ^{Note} , P10 to P14, P40 to P42, P125, RESET 30-pin products: P00, P01, P10 to P17, P30, P31, P40, P50, P51, P120, P147	V _I = V _{SS} , input port	10	20	100	k Ω

Note 24-pin products only.**Remark** Unless specified otherwise, the characteristics of alternate-function pins are the same as those of the port pins.

3.3.2 Supply current characteristics

(1) 20-, 24-pin products

(T_A = -40 to +105°C, 2.4 V ≤ V_{DD} ≤ 5.5 V, V_{SS} = 0 V)

(1/2)

Parameter	Symbol	Conditions				MIN.	TYP.	MAX.	Unit	
Supply current ^{Note 1}	I _{DD1}	Operating mode	HS (High-speed main) mode ^{Note 4}	f _{IH} = 24 MHz ^{Note 3}	Basic operation	V _{DD} = 5.0 V		1.5		mA
						V _{DD} = 3.0 V		1.5		
				Normal operation	V _{DD} = 5.0 V		3.3	5.3	mA	
					V _{DD} = 3.0 V		3.3	5.3		
				f _{IH} = 16 MHz ^{Note 3}	V _{DD} = 5.0 V		2.5	3.9	mA	
					V _{DD} = 3.0 V		2.5	3.9		
		f _{MX} = 20 MHz ^{Note 2} , V _{DD} = 5.0 V	Square wave input		2.8	4.7	mA			
			Resonator connection		3.0	4.8				
		f _{MX} = 20 MHz ^{Note 2} , V _{DD} = 3.0 V	Square wave input		2.8	4.7	mA			
			Resonator connection		3.0	4.8				
		f _{MX} = 10 MHz ^{Note 2} , V _{DD} = 5.0 V	Square wave input		1.8	2.8	mA			
			Resonator connection		1.8	2.8				
f _{MX} = 10 MHz ^{Note 2} , V _{DD} = 3.0 V	Square wave input		1.8	2.8	mA					
	Resonator connection		1.8	2.8						

Notes 1. Total current flowing into V_{DD}, including the input leakage current flowing when the level of the input pin is fixed to V_{DD} or V_{SS}. The values below the MAX. column include the peripheral operation current. However, not including the current flowing into the A/D converter, LVD circuit, I/O port, and on-chip pull-up/pull-down resistors and the current flowing during data flash rewrite.

- 2. When high-speed on-chip oscillator clock is stopped.
- 3. When high-speed system clock is stopped
- 4. Relationship between operation voltage width, operation frequency of CPU and operation mode is as follows.

HS (High speed main) mode: V_{DD} = 2.7 V to 5.5 V @1 MHz to 24 MHz
 V_{DD} = 2.4 V to 5.5 V @1 MHz to 16 MHz

- Remarks 1.** f_{MX}: High-speed system clock frequency (X1 clock oscillation frequency or external main system clock frequency)
- 2. f_{IH}: high-speed on-chip oscillator clock frequency
 - 3. Temperature condition of the TYP. value is T_A = 25°C.

(1) 20-, 24-pin products

 $(T_A = -40$ to $+105^\circ\text{C}$, $2.4\text{ V} \leq V_{DD} \leq 5.5\text{ V}$, $V_{SS} = 0\text{ V})$

(2/2)

Parameter	Symbol	Conditions		MIN.	TYP.	MAX.	Unit		
Supply current ^{Note 1}	I _{DD2} ^{Note 2}	HALT mode	HS (High-speed main) mode ^{Note 6}	f _{IH} = 24 MHz ^{Note 4}	V _{DD} = 5.0 V		440	2230	μA
					V _{DD} = 3.0 V		440	2230	
				f _{IH} = 16 MHz ^{Note 4}	V _{DD} = 5.0 V		400	1650	μA
					V _{DD} = 3.0 V		400	1650	
				f _{MX} = 20 MHz ^{Note 3} , V _{DD} = 5.0 V	Square wave input		280	1900	μA
					Resonator connection		450	2000	
				f _{MX} = 20 MHz ^{Note 3} , V _{DD} = 3.0 V	Square wave input		280	1900	μA
					Resonator connection		450	2000	
				f _{MX} = 10 MHz ^{Note 3} , V _{DD} = 5.0 V	Square wave input		190	1010	μA
					Resonator connection		260	1090	
				f _{MX} = 10 MHz ^{Note 3} , V _{DD} = 3.0 V	Square wave input		190	1010	μA
					Resonator connection		260	1090	
I _{DD3} ^{Note 5}	STOP mode	T _A = -40°C			0.19	0.50	μA		
		T _A = +25°C			0.24	0.50			
		T _A = +50°C			0.32	0.80			
		T _A = +70°C			0.48	1.20			
		T _A = +85°C			0.74	2.20			
		T _A = +105°C			1.50	10.20			

- Notes**
- Total current flowing into V_{DD}, including the input leakage current flowing when the level of the input pin is fixed to V_{DD} or V_{SS}. The values below the MAX. column include the peripheral operation current. However, not including the current flowing into the A/D converter, LVD circuit, I/O port, and on-chip pull-up/pull-down resistors and the current flowing during data flash rewrite.
 - During HALT instruction execution by flash memory.
 - When high-speed on-chip oscillator clock is stopped.
 - When high-speed system clock is stopped.
 - Not including the current flowing into the 12-bit interval timer and watchdog timer.
 - Relationship between operation voltage width, operation frequency of CPU and operation mode is as follows.

HS (High speed main) mode: V_{DD} = 2.7 V to 5.5 V @1 MHz to 24 MHz

V_{DD} = 2.4 V to 5.5 V @1 MHz to 16 MHz

- Remarks**
- f_{MX}: High-speed system clock frequency (X1 clock oscillation frequency or external main system clock frequency)
 - f_{IH}: high-speed on-chip oscillator clock frequency
 - Except temperature condition of the TYP. value is T_A = 25°C, other than STOP mode

(2) 30-pin products

(T_A = -40 to +105°C, 2.4 V ≤ V_{DD} ≤ 5.5 V, V_{SS} = 0 V)

(1/2)

Parameter	Symbol	Conditions				MIN.	TYP.	MAX.	Unit	
Supply current ^{Note 1}	I _{DD1}	Operating mode	HS (High-speed main) mode ^{Note 4}	f _{HI} = 24 MHz ^{Note 3}	Basic operation	V _{DD} = 5.0 V		1.5		mA
						V _{DD} = 3.0 V		1.5		
					Normal operation	V _{DD} = 5.0 V		3.7	5.8	mA
						V _{DD} = 3.0 V		3.7	5.8	
					f _{HI} = 16 MHz ^{Note 3}	V _{DD} = 5.0 V		2.7	4.2	mA
						V _{DD} = 3.0 V		2.7	4.2	
				f _{MX} = 20 MHz ^{Note 2} , V _{DD} = 5.0 V	Square wave input		3.0	4.9	mA	
					Resonator connection		3.2	5.0		
				f _{MX} = 20 MHz ^{Note 2} , V _{DD} = 3.0 V	Square wave input		3.0	4.9	mA	
					Resonator connection		3.2	5.0		
				f _{MX} = 10 MHz ^{Note 2} , V _{DD} = 5.0 V	Square wave input		1.9	2.9	mA	
					Resonator connection		1.9	2.9		
f _{MX} = 10 MHz ^{Note 2} , V _{DD} = 3.0 V	Square wave input		1.9	2.9	mA					
	Resonator connection		1.9	2.9						

- Notes**
- Total current flowing into V_{DD}, including the input leakage current flowing when the level of the input pin is fixed to V_{DD} or V_{SS}. The values below the MAX. column include the peripheral operation current. However, not including the current flowing into the A/D converter, LVD circuit, I/O port, and on-chip pull-up/pull-down resistors and the current flowing during data flash rewrite.
 - When high-speed on-chip oscillator clock is stopped.
 - When high-speed system clock is stopped
 - Relationship between operation voltage width, operation frequency of CPU and operation mode is as follows.
 HS (High speed main) mode: V_{DD} = 2.7 V to 5.5 V @1 MHz to 24 MHz
 V_{DD} = 2.4 V to 5.5 V @1 MHz to 16 MHz

- Remarks**
- f_{MX}: High-speed system clock frequency (X1 clock oscillation frequency or external main system clock frequency)
 - f_{HI}: high-speed on-chip oscillator clock frequency
 - Temperature condition of the TYP. value is T_A = 25°C.

(2) 30-pin products**($T_A = -40$ to $+105^\circ\text{C}$, $2.4\text{ V} \leq V_{DD} \leq 5.5\text{ V}$, $V_{SS} = 0\text{ V}$)****(2/2)**

Parameter	Symbol	Conditions			MIN.	TYP.	MAX.	Unit	
Supply current Note 1	I _{DD2} Note 2	HALT mode	HS (High-speed main) mode Note 6	f _{IH} = 24 MHz Note 4	V _{DD} = 5.0 V		440	2300	μA
					V _{DD} = 3.0 V		440	2300	
				f _{IH} = 16 MHz Note 4	V _{DD} = 5.0 V		400	1700	μA
					V _{DD} = 3.0 V		400	1700	
				f _{MX} = 20 MHz Note 3, V _{DD} = 5.0 V	Square wave input		280	1900	μA
					Resonator connection		450	2000	
				f _{MX} = 20 MHz Note 3, V _{DD} = 3.0 V	Square wave input		280	1900	μA
					Resonator connection		450	2000	
				f _{MX} = 10 MHz Note 3, V _{DD} = 5.0 V	Square wave input		190	1020	μA
					Resonator connection		260	1100	
				f _{MX} = 10 MHz Note 3, V _{DD} = 3.0 V	Square wave input		190	1020	μA
					Resonator connection		260	1100	
I _{DD3} Note 5	STOP mode	T _A = -40°C				0.18	0.50	μA	
		T _A = +25°C				0.23	0.50		
		T _A = +50°C				0.30	1.10		
		T _A = +70°C				0.46	1.90		
		T _A = +85°C				0.75	3.30		
		T _A = +105°C				2.94	15.30		

- Notes**
- Total current flowing into V_{DD}, including the input leakage current flowing when the level of the input pin is fixed to V_{DD} or V_{SS}. The values below the MAX. column include the peripheral operation current. However, not including the current flowing into the A/D converter, LVD circuit, I/O port, and on-chip pull-up/pull-down resistors and the current flowing during data flash rewrite.
 - During HALT instruction execution by flash memory.
 - When high-speed on-chip oscillator clock is stopped.
 - When high-speed system clock is stopped.
 - Not including the current flowing into the 12-bit interval timer and watchdog timer.
 - Relationship between operation voltage width, operation frequency of CPU and operation mode is as follows.

HS (High speed main) mode: V_{DD} = 2.7 V to 5.5 V @1 MHz to 24 MHz

V_{DD} = 2.4 V to 5.5 V @1 MHz to 16 MHz

- Remarks**
- f_{MX}: High-speed system clock frequency (X1 clock oscillation frequency or external main system clock frequency)
 - f_{IH}: high-speed on-chip oscillator clock frequency
 - Except STOP mode, temperature condition of the TYP. value is T_A = 25°C.

(3) Peripheral functions (Common to all products)**($T_A = -40$ to $+105^\circ\text{C}$, $2.4\text{ V} \leq V_{DD} \leq 5.5\text{ V}$, $V_{SS} = 0\text{ V}$)**

Parameter	Symbol	Conditions		MIN.	TYP.	MAX.	Unit
Low-speed onchip oscillator operating current	I_{FIL} ^{Note 1}				0.20		μA
12-bit interval timer operating current	I_{TMKA} ^{Notes 1, 2, 3}				0.02		μA
Watchdog timer operating current	I_{WDT} ^{Notes 1, 2, 4}	$f_{IL} = 15\text{ kHz}$			0.22		μA
A/D converter operating current	I_{ADC} ^{Notes 1, 5}	When conversion at maximum speed	Normal mode, $AV_{REFP} = V_{DD} = 5.0\text{ V}$		1.30	1.70	mA
			Low voltage mode, $AV_{REFP} = V_{DD} = 3.0\text{ V}$		0.50	0.70	mA
A/D converter reference voltage operating current	I_{ADREF} ^{Note 1}				75.0		μA
Temperature sensor operating current	I_{TMPS} ^{Note 1}				75.0		μA
LVD operating current	I_{LVD} ^{Notes 1, 6}				0.08		μA
Self-programming operating current	I_{FSP} ^{Notes 1, 8}				2.00	12.20	mA
BGO operating current	I_{BGO} ^{Notes 1, 7}				2.00	12.20	mA
SNOOZE operating current	I_{SNOZ} ^{Note 1}	ADC operation	The mode is performed ^{Note 9}		0.50	1.10	mA
			The A/D conversion operations are performed, Low voltage mode, $AV_{REFP} = V_{DD} = 3.0\text{ V}$		1.20	2.04	mA
		Simplified SPI (CSI)/UART operation				0.70	1.54

Notes 1. Current flowing to the V_{DD} .**2.** When high speed on-chip oscillator and high-speed system clock are stopped.**3.** Current flowing only to the 12-bit interval timer (excluding the operating current of the low-speed on-chip oscillator). The current value of the RL78 microcontrollers is the sum of I_{DD1} , I_{DD2} or I_{DD3} , and I_{FIL} and I_{TMKA} when the 12-bit interval timer operates.**4.** Current flowing only to the watchdog timer (including the operating current of the low-speed on-chip oscillator). The current value of the RL78 microcontrollers is the sum of I_{DD1} , I_{DD2} or I_{DD3} and I_{WDT} when the watchdog timer operates.**5.** Current flowing only to the A/D converter. The current value of the RL78 microcontrollers is the sum of I_{DD1} or I_{DD2} and I_{ADC} when the A/D converter operates in an operation mode or the HALT mode.**6.** Current flowing only to the LVD circuit. The current value of the RL78 microcontrollers is the sum of I_{DD1} , I_{DD2} or I_{DD3} and I_{LVD} when the LVD circuit operates.**7.** Current flowing only during data flash rewrite.**8.** Current flowing only during self programming.**9.** For shift time to the SNOOZE mode, see **17.3.3 SNOOZE mode** in the RL78/G12 User's Manual.**Remarks 1.** f_{IL} : Low-speed on-chip oscillator clock frequency**2.** Temperature condition of the TYP. value is $T_A = 25^\circ\text{C}$

3.4 AC Characteristics

(TA = -40 to +105°C, 2.4 V ≤ VDD ≤ 5.5 V, VSS = 0 V)

Items	Symbol	Conditions		MIN.	TYP.	MAX.	Unit
Instruction cycle (minimum instruction execution time)	TCY	Main system clock (fMAIN) operation	HS (High-speed main) mode	2.7 V ≤ VDD ≤ 5.5 V	0.04167	1	μs
				2.4 V ≤ VDD < 2.7 V	0.0625	1	μs
		During self programming	HS (High-speed main) mode	2.7 V ≤ VDD ≤ 5.5 V	0.04167	1	μs
				2.4 V ≤ VDD < 2.7 V	0.0625	1	μs
External main system clock frequency	fEX	2.7 V ≤ VDD ≤ 5.5 V		1.0		20.0	MHz
		2.4 V ≤ VDD < 2.7 V		1.0		16.0	MHz
External main system clock input high-level width, low-level width	tEXH, tEXL	2.7 V ≤ VDD ≤ 5.5 V		24			ns
		2.4 V ≤ VDD < 2.7 V		30			ns
TI00 to TI07 input high-level width, low-level width	tTIH, tTIL			1/fMCK + 10			ns
TO00 to TO07 output frequency	fTO	4.0 V ≤ VDD ≤ 5.5 V				12	MHz
		2.7 V ≤ VDD < 4.0 V				8	MHz
		2.4 V ≤ VDD < 2.7 V				4	MHz
PCLBUZ0, or PCLBUZ1 output frequency	fPCL	4.0 V ≤ VDD ≤ 5.5 V				16	MHz
		2.7 V ≤ VDD < 4.0 V				8	MHz
		2.4 V ≤ VDD < 2.7 V				4	MHz
INTP0 to INTP5 input high-level width, low-level width	tINTH, tINTL			1			μs
KR0 to KR9 input available width	tKR			250			ns
RESET low-level width	tRSL			10			μs

Remark fMCK: Timer array unit operation clock frequency
 (Operation clock to be set by the timer clock select register 0 (TPS0) and the CKS0n bit of timer mode register 0n (TMR0n). n: Channel number (n = 0 to 7))

Minimum Instruction Execution Time during Main System Clock Operation



AC Timing Test Point



External Main System Clock Timing



TI/TO Timing

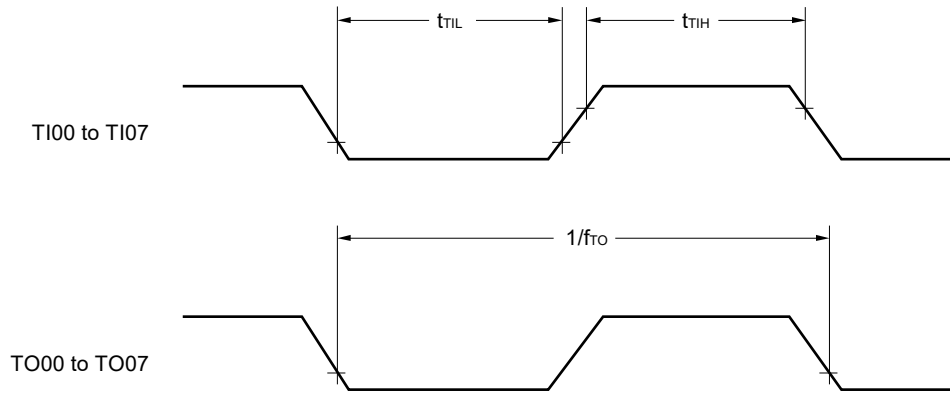

Interrupt Request Input Timing

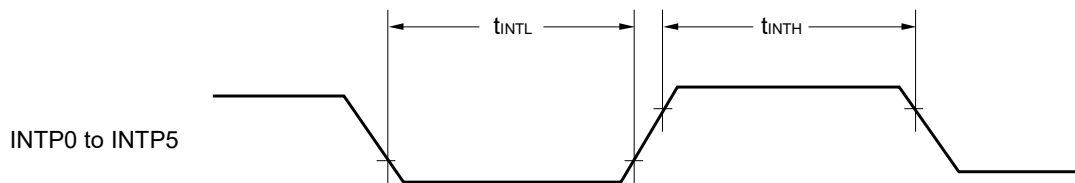

Key Interrupt Input Timing



RESET Input Timing

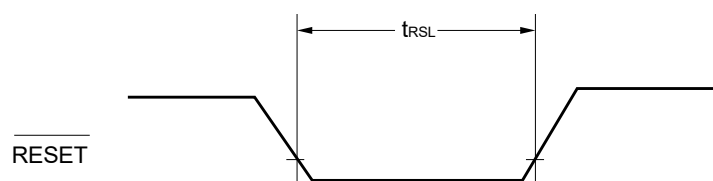

3.5 Peripheral Functions Characteristics

AC Timing Test Point



3.5.1 Serial array unit

(1) During communication at same potential (UART mode)

(T_A = -40 to +105°C, 2.4 V ≤ V_{DD} ≤ 5.5 V, V_{SS} = 0 V)

Parameter	Symbol	Conditions	HS (high-speed main) Mode		Unit
			MIN.	MAX.	
Transfer rate				f _{MCK} /12	bps
Note 1		Theoretical value of the maximum transfer rate f _{CLK} = f _{MCK} Note 2		2.0	Mbps

- Notes**
1. Transfer rate in the SNOOZE mode is 4800 bps only.
 2. The maximum operating frequencies of the CPU/peripheral hardware clock (f_{CLK}) are:
 HS (high-speed main) mode: 24 MHz (2.7 V ≤ V_{DD} ≤ 5.5 V)
 16 MHz (2.4 V ≤ V_{DD} ≤ 5.5 V)

Caution Select the normal input buffer for the RxDq pin and the normal output mode for the TxDq pin by using port input mode register g (PIMg) and port output mode register g (POMg).

UART mode connection diagram (during communication at same potential)



UART mode bit width (during communication at same potential) (reference)



- Remarks**
1. q: UART number (q = 0 to 2), g: PIM, POM number (g = 0, 1)
 2. f_{MCK}: Serial array unit operation clock frequency
 (Operation clock to be set by the serial clock select register m (SPSm) and the CKSmn bit of serial mode register mn (SMRmn).
 m: Unit number, n: Channel number (mn = 00 to 03, 10, 11))

(2) During communication at same potential (simplified SPI (CSI) mode) (master mode, SCKp... internal clock output)**($T_A = -40$ to $+105^\circ\text{C}$, $2.4\text{ V} \leq V_{DD} \leq 5.5\text{ V}$, $V_{SS} = 0\text{ V}$)**

Parameter	Symbol	Conditions	HS (high-speed main) Mode		Unit	
			MIN.	MAX.		
SCKp cycle time	t_{KCY1}	$t_{KCY1} \geq 4/f_{CLK}$	$2.7\text{ V} \leq V_{DD} \leq 5.5\text{ V}$	334		ns
			$2.4\text{ V} \leq V_{DD} \leq 5.5\text{ V}$	500		ns
SCKp high-/low-level width	t_{KH1} , t_{KL1}	$4.0\text{ V} \leq V_{DD} \leq 5.5\text{ V}$	$t_{KCY1}/2-24$		ns	
		$2.7\text{ V} \leq V_{DD} \leq 5.5\text{ V}$	$t_{KCY1}/2-36$		ns	
		$2.4\text{ V} \leq V_{DD} \leq 5.5\text{ V}$	$t_{KCY1}/2-76$		ns	
Slp setup time (to SCKp \uparrow) ^{Note 1}	t_{SIK1}	$4.0\text{ V} \leq V_{DD} \leq 5.5\text{ V}$	66		ns	
		$2.7\text{ V} \leq V_{DD} \leq 5.5\text{ V}$	66		ns	
		$2.4\text{ V} \leq V_{DD} \leq 5.5\text{ V}$	113		ns	
Slp hold time (from SCKp \uparrow) ^{Note 2}	t_{KSI1}		38		ns	
Delay time from SCKp \downarrow to SOp output ^{Note 3}	t_{KSO1}	$C = 30\text{ pF}$ ^{Note 4}		50	ns	

- Notes**
1. When DAPmn = 0 and CKPmn = 0, or DAPmn = 1 and CKPmn = 1. The Slp setup time becomes “to SCKp \downarrow ” when DAPmn = 0 and CKPmn = 1, or DAPmn = 1 and CKPmn = 0.
 2. When DAPmn = 0 and CKPmn = 0, or DAPmn = 1 and CKPmn = 1. The Slp hold time becomes “from SCKp \downarrow ” when DAPmn = 0 and CKPmn = 1, or DAPmn = 1 and CKPmn = 0.
 3. When DAPmn = 0 and CKPmn = 0, or DAPmn = 1 and CKPmn = 1. The delay time to SOp output becomes “from SCKp \uparrow ” when DAPmn = 0 and CKPmn = 1, or DAPmn = 1 and CKPmn = 0.
 4. C is the load capacitance of the SCKp and SOp output lines.

Caution Select the normal input buffer for the Slp pin and the normal output mode for the SOp and SCKp pins by using port input mode register 1 (PIM1) and port output mode registers 0, 1, 4 (POM0, POM1, POM4).

- Remarks**
1. p: CSI number (p = 00, 01, 11, 20), m: Unit number (m = 0, 1), n: Channel number (n = 0, 1, 3)
 2. f_{MCK} : Serial array unit operation clock frequency
(Operation clock to be set by the serial clock select register m (SPSm) and the CKSmn bit of serial mode register mn (SMRmn). m: Unit number (m = 0, 1), n: Channel number (n = 0, 1, 3))

(3) During communication at same potential (simplified SPI (CSI) mode) (slave mode, SCKp... external clock input)**(T_A = -40 to +105°C, 2.4 V ≤ V_{DD} ≤ 5.5 V, V_{SS} = 0 V)**

Parameter	Symbol	Conditions		HS (high-speed main) Mode		Unit
				MIN.	MAX.	
SCKp cycle time ^{Note 5}	t _{KCY2}	4.0 V ≤ V _{DD} ≤ 5.5 V	20 MHz < f _{MCK}	16/f _{MCK}		ns
			f _{MCK} ≤ 20 MHz	12/f _{MCK}		ns
		2.7 V ≤ V _{DD} ≤ 5.5 V	16 MHz < f _{MCK}	16/f _{MCK}		ns
			f _{MCK} ≤ 16 MHz	12/f _{MCK}		ns
		2.4 V ≤ V _{DD} ≤ 5.5 V		12/f _{MCK} and 1000		ns
SCKp high-/low-level width	t _{KH2} ,	4.0 V ≤ V _{DD} ≤ 5.5 V		t _{KCY2} /2-14		ns
	t _{KL2}	2.7 V ≤ V _{DD} ≤ 5.5 V		t _{KCY2} /2-16		ns
		2.4 V ≤ V _{DD} ≤ 5.5 V		t _{KCY2} /2-36		ns
Slp setup time (to SCKp↑) ^{Note 1}	t _{SIK2}	2.7 V ≤ V _{DD} ≤ 5.5 V		1/f _{MCK} + 40		ns
		2.4 V ≤ V _{DD} ≤ 5.5 V		1/f _{MCK} + 60		ns
Slp hold time (from SCKp↑) ^{Note 2}	t _{KSI2}			1/f _{MCK} + 62		ns
Delay time from SCKp↓ to SO _p output ^{Note 3}	t _{KSO2}	C = 30 pF ^{Note 4}	2.7 V ≤ V _{DD} ≤ 5.5 V		2/f _{MCK} + 66	ns
			2.4 V ≤ V _{DD} ≤ 5.5 V		2/f _{MCK} + 113	ns

- Notes**
1. When DAP_mn = 0 and CKP_mn = 0, or DAP_mn = 1 and CKP_mn = 1. The Slp setup time becomes “to SCKp↓” when DAP_mn = 0 and CKP_mn = 1, or DAP_mn = 1 and CKP_mn = 0.
 2. When DAP_mn = 0 and CKP_mn = 0, or DAP_mn = 1 and CKP_mn = 1. The Slp hold time becomes “from SCKp↓” when DAP_mn = 0 and CKP_mn = 1, or DAP_mn = 1 and CKP_mn = 0.
 3. When DAP_mn = 0 and CKP_mn = 0, or DAP_mn = 1 and CKP_mn = 1. The delay time to SO_p output becomes “from SCKp↑” when DAP_mn = 0 and CKP_mn = 1, or DAP_mn = 1 and CKP_mn = 0.
 4. C is the load capacitance of the SO_p output lines.
 5. Transfer rate in the SNOOZE mode: MAX. 1 Mbps.

Caution Select the normal input buffer for the Slp and SCKp pins and the normal output mode for the SO_p pin by using port input mode register 1 (PIM1) and port output mode registers 0, 1, 4 (POM0, POM1, POM4).

Simplified SPI (CSI) mode connection diagram (during communication at same potential)

**Simplified SPI (CSI) mode serial transfer timing (during communication at same potential)
(When DAPmn = 0 and CKPmn = 0, or DAPmn = 1 and CKPmn = 1.)**

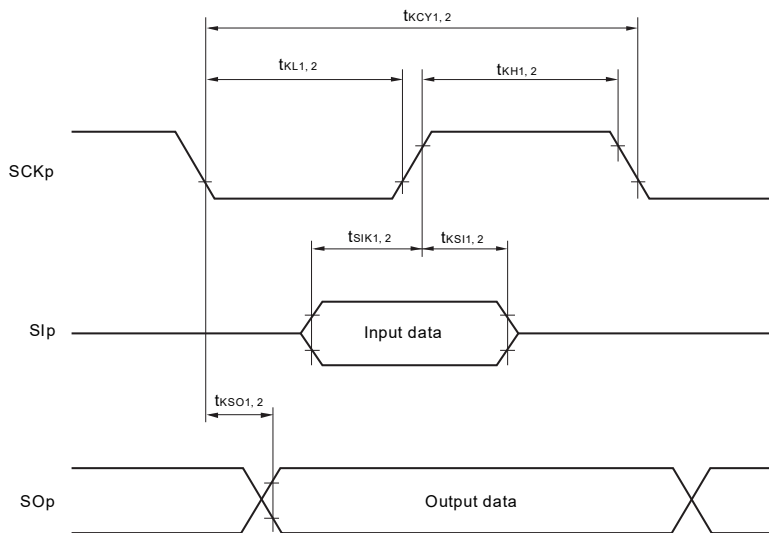

**Simplified SPI (CSI) mode serial transfer timing (during communication at same potential)
(When DAPmn = 0 and CKPmn = 1, or DAPmn = 1 and CKPmn = 0.)**



- Remarks 1.** p: CSI number (p = 00, 01, 11, 20), m: Unit number (m = 0, 1), n: Channel number (n = 0, 1, 3)
2. f_{MCK} : Serial array unit operation clock frequency
 (Operation clock to be set by the serial clock select register m (SPSm) and the CKSmn bit of serial mode register mn (SMRmn). m: Unit number (m = 0,1), n: Channel number (n = 0, 1, 3))

(4) During communication at same potential (simplified I²C mode)

(T_A = -40 to +105°C, 2.4 V ≤ V_{DD} ≤ 5.5 V, V_{SS} = 0 V)

Parameter	Symbol	Conditions	HS (high-speed main) Mode		Unit
			MIN.	MAX.	
SCLr clock frequency	f _{SCL}	C _b = 100 pF, R _b = 3 kΩ		100 ^{Note 1}	kHz
Hold time when SCLr = "L"	t _{LOW}	C _b = 100 pF, R _b = 3 kΩ	4600		ns
Hold time when SCLr = "H"	t _{HIGH}	C _b = 100 pF, R _b = 3 kΩ	4600		ns
Data setup time (reception)	t _{SU:DAT}	C _b = 100 pF, R _b = 3 kΩ	1/f _{MCK} + 580 ^{Note 2}		ns
Data hold time (transmission)	t _{HD:DAT}	C _b = 100 pF, R _b = 3 kΩ	0	1420	ns

- Notes**
1. The value must be equal to or less than f_{MCK}/4.
 2. Set t_{SU:DAT} so that it will not exceed the hold time when SCLr = "L" or SCLr = "H".

Caution Select the N-ch open drain output (V_{DD} tolerance) mode for SDAr by using port output mode register h (POMh).

Simplified I²C mode connection diagram (during communication at same potential)



Simplified I²C mode serial transfer timing (during communication at same potential)



- Remarks**
1. R_b [Ω]: Communication line (SDAr) pull-up resistance
C_b [F]: Communication line (SCLr, SDAr) load capacitance
 2. r: IIC number (r = 00, 01, 11, 20), h: = POM number (h = 0, 1, 4, 5)
 3. f_{MCK}: Serial array unit operation clock frequency
(Operation clock to be set by the serial clock select register m (SPSm) and the CKSmn bit of serial mode register mn (SMRmn).
m: Unit number (m = 0, 1), n: Channel number (0, 1, 3))

(5) Communication at different potential (1.8 V, 2.5 V, 3 V) (UART mode)

(T_A = -40 to +105°C, 2.4 V ≤ V_{DD} ≤ 5.5 V, V_{SS} = 0 V)

Parameter	Symbol	Conditions		HS (high-speed main) Mode		Unit
				MIN.	MAX.	
Transfer rate ^{Note 4}		Reception	4.0 V ≤ V _{DD} ≤ 5.5 V, 2.7 V ≤ V _b ≤ 4.0 V		f _{MCK} /12 Note 1	bps
				Theoretical value of the maximum transfer rate f _{MCK} = f _{CLK} Note 2	2.0	Mbps
			2.7 V ≤ V _{DD} < 4.0 V, 2.3 V ≤ V _b ≤ 2.7 V		f _{MCK} /12 Note 1	bps
				Theoretical value of the maximum transfer rate f _{MCK} = f _{CLK} Note 2	2.0	Mbps
		2.4 V ≤ V _{DD} < 3.3 V, 1.6 V ≤ V _b ≤ 2.0 V		f _{MCK} /12 Note 1	bps	
			Theoretical value of the maximum transfer rate f _{MCK} = f _{CLK} Note 2	2.0	Mbps	
		Transmission	4.0 V ≤ V _{DD} ≤ 5.5 V, 2.7 V ≤ V _b ≤ 4.0 V		Note 3	bps
				Theoretical value of the maximum transfer rate C _b = 50 pF, R _b = 1.4 kΩ, V _b = 2.7 V	2.0 Note 4	Mbps
			2.7 V ≤ V _{DD} < 4.0 V, 2.3 V ≤ V _b ≤ 2.7 V,		Note 5	bps
				Theoretical value of the maximum transfer rate C _b = 50 pF, R _b = 2.7 kΩ, V _b = 2.3 V	1.2 Note 6	Mbps
2.4 V ≤ V _{DD} < 3.3 V, 1.6 V ≤ V _b ≤ 2.0 V			Notes 2, 7	bps		
	Theoretical value of the maximum transfer rate C _b = 50 pF, R _b = 5.5 kΩ, V _b = 1.6 V		0.43 Note 8	Mbps		

- Notes**
- Transfer rate in the SNOOZE mode is 4800 bps only.
 - The maximum operating frequencies of the CPU/peripheral hardware clock (f_{CLK}) are:
 HS (high-speed main) mode: 24 MHz (2.7 V ≤ V_{DD} ≤ 5.5 V)
 16 MHz (2.4 V ≤ V_{DD} ≤ 5.5 V)
 - The smaller maximum transfer rate derived by using f_{MCK}/12 or the following expression is the valid maximum transfer rate.
 Expression for calculating the transfer rate when 4.0 V ≤ V_{DD} ≤ 5.5 V and 2.7 V ≤ V_b ≤ 4.0 V

$$\text{Maximum transfer rate} = \frac{1}{\{-C_b \times R_b \times \ln(1 - \frac{2.2}{V_b})\} \times 3} \text{ [bps]}$$

$$\text{Baud rate error (theoretical value)} = \frac{\frac{1}{\text{Transfer rate} \times 2} - \{-C_b \times R_b \times \ln(1 - \frac{2.2}{V_b})\}}{(\frac{1}{\text{Transfer rate}}) \times \text{Number of transferred bits}} \times 100 [\%]$$

* This value is the theoretical value of the relative difference between the transmission and reception sides.

4. This value as an example is calculated when the conditions described in the “Conditions” column are met. Refer to **Note 3** above to calculate the maximum transfer rate under conditions of the customer.
5. The smaller maximum transfer rate derived by using f_{MCK}/12 or the following expression is the valid maximum transfer rate.

Expression for calculating the transfer rate when 2.7 V ≤ V_{DD} < 4.0 V and 2.3 V ≤ V_b ≤ 2.7 V

$$\text{Maximum transfer rate} = \frac{1}{\{-C_b \times R_b \times \ln(1 - \frac{2.0}{V_b})\} \times 3} \quad [\text{bps}]$$

$$\text{Baud rate error (theoretical value)} = \frac{\frac{1}{\text{Transfer rate} \times 2} - \{-C_b \times R_b \times \ln(1 - \frac{2.0}{V_b})\}}{(\frac{1}{\text{Transfer rate}}) \times \text{Number of transferred bits}} \times 100 [\%]$$

* This value is the theoretical value of the relative difference between the transmission and reception sides.

6. This value as an example is calculated when the conditions described in the “Conditions” column are met. Refer to **Note 5** above to calculate the maximum transfer rate under conditions of the customer.
7. The smaller maximum transfer rate derived by using f_{MCK}/12 or the following expression is the valid maximum transfer rate.

Expression for calculating the transfer rate when 2.4 V ≤ V_{DD} < 3.3 V, 1.6 V ≤ V_b ≤ 2.0 V

$$\text{Maximum transfer rate} = \frac{1}{\{-C_b \times R_b \times \ln(1 - \frac{1.5}{V_b})\} \times 3} \quad [\text{bps}]$$

$$\text{Baud rate error (theoretical value)} = \frac{\frac{1}{\text{Transfer rate} \times 2} - \{-C_b \times R_b \times \ln(1 - \frac{1.5}{V_b})\}}{(\frac{1}{\text{Transfer rate}}) \times \text{Number of transferred bits}} \times 100 [\%]$$

* This value is the theoretical value of the relative difference between the transmission and reception sides.

8. This value as an example is calculated when the conditions described in the “Conditions” column are met. Refer to **Note 7** above to calculate the maximum transfer rate under conditions of the customer.

Caution Select the TTL input buffer for the RxDq pin and the N-ch open drain output (V_{DD} tolerance) mode for the TxDq pin by using port input mode register g (PIMg) and port output mode register g (POMg). For V_{IH} and V_{IL}, see the DC characteristics with TTL input buffer selected.

UART mode connection diagram (during communication at different potential)



UART mode bit width (during communication at different potential) (reference)



- Remarks**
1. $R_b[\Omega]$: Communication line (TxDq) pull-up resistance, $C_b[F]$: Communication line (TxDq) load capacitance, $V_b[V]$: Communication line voltage
 2. q: UART number (q = 0 to 2), g: PIM and POM number (g = 0, 1)
 3. f_{MCK} : Serial array unit operation clock frequency
(Operation clock to be set by the serial clock select register m (SPS_m) and the CKS_{mn} bit of serial mode register mn (SMR_{mn}).
m: Unit number, n: Channel number (mn = 00 to 03, 10, 11))
 4. UART0 of the 20- and 24-pin products supports communication at different potential only when the peripheral I/O redirection function is not used.

(6) Communication at different potential (1.8 V, 2.5 V, 3 V) (simplified SPI (CSI) mode) (master mode, SCKp... internal clock output) (1/3)**($T_A = -40$ to $+105^\circ\text{C}$, $2.4\text{ V} \leq V_{DD} \leq V_{DD} \leq 5.5\text{ V}$, $V_{SS} = 0\text{ V}$)**

Parameter	Symbol	Conditions	HS (high-speed main) Mode		Unit
			MIN.	MAX.	
SCKp cycle time	t_{KCY1}	$t_{KCY1} \geq 4/f_{CLK}$ $4.0\text{ V} \leq V_{DD} \leq 5.5\text{ V}$, $2.7\text{ V} \leq V_b \leq 4.0\text{ V}$, $C_b = 30\text{ pF}$, $R_b = 1.4\text{ k}\Omega$	600		ns
		$2.7\text{ V} \leq V_{DD} < 4.0\text{ V}$, $2.3\text{ V} \leq V_b \leq 2.7\text{ V}$, $C_b = 30\text{ pF}$, $R_b = 2.7\text{ k}\Omega$	1000		ns
		$2.4\text{ V} \leq V_{DD} < 3.3\text{ V}$, $1.6\text{ V} \leq V_b \leq 2.0\text{ V}$, $C_b = 30\text{ pF}$, $R_b = 5.5\text{ k}\Omega$	2300		ns
SCKp high-level width	t_{KH1}	$4.0\text{ V} \leq V_{DD} \leq 5.5\text{ V}$, $2.7\text{ V} \leq V_b \leq 4.0\text{ V}$, $C_b = 30\text{ pF}$, $R_b = 1.4\text{ k}\Omega$	$t_{KCY1}/2 - 150$		ns
		$2.7\text{ V} \leq V_{DD} < 4.0\text{ V}$, $2.3\text{ V} \leq V_b \leq 2.7\text{ V}$, $C_b = 30\text{ pF}$, $R_b = 2.7\text{ k}\Omega$	$t_{KCY1}/2 - 340$		ns
		$2.4\text{ V} \leq V_{DD} < 3.3\text{ V}$, $1.6\text{ V} \leq V_b \leq 2.0\text{ V}$, $C_b = 30\text{ pF}$, $R_b = 5.5\text{ k}\Omega$	$t_{KCY1}/2 - 916$		ns
SCKp low-level width	t_{KL1}	$4.0\text{ V} \leq V_{DD} \leq 5.5\text{ V}$, $2.7\text{ V} \leq V_b \leq 4.0\text{ V}$, $C_b = 30\text{ pF}$, $R_b = 1.4\text{ k}\Omega$	$t_{KCY1}/2 - 24$		ns
		$2.7\text{ V} \leq V_{DD} < 4.0\text{ V}$, $2.3\text{ V} \leq V_b \leq 2.7\text{ V}$, $C_b = 30\text{ pF}$, $R_b = 2.7\text{ k}\Omega$	$t_{KCY1}/2 - 36$		ns
		$2.4\text{ V} \leq V_{DD} < 3.3\text{ V}$, $1.6\text{ V} \leq V_b \leq 2.0\text{ V}$, $C_b = 30\text{ pF}$, $R_b = 5.5\text{ k}\Omega$	$t_{KCY1}/2 - 100$		ns

Cautions 1. Select the TTL input buffer for the SIp pin and the N-ch open drain output (V_{DD} tolerance) mode for the SOp pin and SCKp pin by using port input mode register 1 (PIM1) and port output mode register 1 (POM1). For V_{IH} and V_{IL} , see the DC characteristics with TTL input buffer selected.

2. CSI01 and CSI11 cannot communicate at different potential.

Remarks 1. R_b [Ω]: Communication line (SCKp, SOp) pull-up resistance, C_b [F]: Communication line (SCKp, SOp) load capacitance, V_b [V]: Communication line voltage

2. p: CSI number (p = 00, 20)

(6) Communication at different potential (1.8 V, 2.5 V, 3 V) (simplified SPI (CSI) mode) (master mode, SCKp... internal clock output) (2/3)**($T_A = -40$ to $+105^\circ\text{C}$, $2.4\text{ V} \leq V_{DD} \leq 5.5\text{ V}$, $V_{SS} = 0\text{ V}$)**

Parameter	Symbol	Conditions	HS (high-speed main) Mode		Unit
			MIN.	MAX.	
Slp setup time (to SCKp \uparrow) Note	t_{SIK1}	$4.0\text{ V} \leq V_{DD} \leq 5.5\text{ V}$, $2.7\text{ V} \leq V_b \leq 4.0\text{ V}$, $C_b = 30\text{ pF}$, $R_b = 1.4\text{ k}\Omega$	162		ns
		$2.7\text{ V} \leq V_{DD} < 4.0\text{ V}$, $2.3\text{ V} \leq V_b \leq 2.7\text{ V}$, $C_b = 30\text{ pF}$, $R_b = 2.7\text{ k}\Omega$	354		ns
		$2.4\text{ V} \leq V_{DD} < 3.3\text{ V}$, $1.6\text{ V} \leq V_b \leq 2.0\text{ V}$, $C_b = 30\text{ pF}$, $R_b = 5.5\text{ k}\Omega$	958		ns
Slp hold time (from SCKp \uparrow) Note	t_{KSI1}	$4.0\text{ V} \leq V_{DD} \leq 5.5\text{ V}$, $2.7\text{ V} \leq V_b \leq 4.0\text{ V}$, $C_b = 30\text{ pF}$, $R_b = 1.4\text{ k}\Omega$	38		ns
		$2.7\text{ V} \leq V_{DD} < 4.0\text{ V}$, $2.3\text{ V} \leq V_b \leq 2.7\text{ V}$, $C_b = 30\text{ pF}$, $R_b = 2.7\text{ k}\Omega$	38		ns
		$2.4\text{ V} \leq V_{DD} < 3.3\text{ V}$, $1.6\text{ V} \leq V_b \leq 2.0\text{ V}$, $C_b = 30\text{ pF}$, $R_b = 5.5\text{ k}\Omega$	38		ns
Delay time from SCKp \downarrow to SO p output Note	t_{KSO1}	$4.0\text{ V} \leq V_{DD} \leq 5.5\text{ V}$, $2.7\text{ V} \leq V_b \leq 4.0\text{ V}$, $C_b = 30\text{ pF}$, $R_b = 1.4\text{ k}\Omega$		200	ns
		$2.7\text{ V} \leq V_{DD} < 4.0\text{ V}$, $2.3\text{ V} \leq V_b \leq 2.7\text{ V}$, $C_b = 30\text{ pF}$, $R_b = 2.7\text{ k}\Omega$		390	ns
		$2.4\text{ V} \leq V_{DD} < 3.3\text{ V}$, $1.6\text{ V} \leq V_b \leq 2.0\text{ V}$, $C_b = 30\text{ pF}$, $R_b = 5.5\text{ k}\Omega$		966	ns

Note When DAPmn = 0 and CKPmn = 0, or DAPmn = 1 and CKPmn = 1.

(Cautions and Remarks are listed on the next page.)

(6) Communication at different potential (1.8 V, 2.5 V, 3 V) (simplified SPI (CSI) mode) (master mode, SCKp... internal clock output) (3/3)

(T_A = -40 to +105°C, 2.4 V ≤ V_{DD} ≤ 5.5 V, V_{SS} = 0 V)

Parameter	Symbol	Conditions	HS (high-speed main) Mode		Unit
			MIN.	MAX.	
Slp setup time (to SCKp↓) <small>Note</small>	t _{SIK1}	4.0 V ≤ V _{DD} ≤ 5.5 V, 2.7 V ≤ V _b ≤ 4.0 V, C _b = 30 pF, R _b = 1.4 kΩ	88		ns
		2.7 V ≤ V _{DD} < 4.0 V, 2.3 V ≤ V _b ≤ 2.7 V, C _b = 30 pF, R _b = 2.7 kΩ	88		ns
		2.4 V ≤ V _{DD} < 3.3 V, 1.6 V ≤ V _b ≤ 2.0 V, C _b = 30 pF, R _b = 5.5 kΩ	220		ns
Slp hold time (from SCKp↓) <small>Note</small>	t _{KSI1}	4.0 V ≤ V _{DD} ≤ 5.5 V, 2.7 V ≤ V _b ≤ 4.0 V, C _b = 30 pF, R _b = 1.4 kΩ	38		ns
		2.7 V ≤ V _{DD} < 4.0 V, 2.3 V ≤ V _b ≤ 2.7 V, C _b = 30 pF, R _b = 2.7 kΩ	38		ns
		2.4 V ≤ V _{DD} < 3.3 V, 1.6 V ≤ V _b ≤ 2.0 V, C _b = 30 pF, R _b = 5.5 kΩ	38		ns
Delay time from SCKp↑ to SO _p output <small>Note</small>	t _{KSO1}	4.0 V ≤ V _{DD} ≤ 5.5 V, 2.7 V ≤ V _b ≤ 4.0 V, C _b = 30 pF, R _b = 1.4 kΩ		50	ns
		2.7 V ≤ V _{DD} < 4.0 V, 2.3 V ≤ V _b ≤ 2.7 V, C _b = 30 pF, R _b = 2.7 kΩ		50	ns
		2.4 V ≤ V _{DD} < 3.3 V, 1.6 V ≤ V _b ≤ 2.0 V, C _b = 30 pF, R _b = 5.5 kΩ		50	ns

Note When DAP_mn = 0 and CKP_mn = 1, or DAP_mn = 1 and CKP_mn = 0.

- Cautions 1.** Select the TTL input buffer for the Slp pin and the N-ch open drain output (V_{DD} tolerance) mode for the SO_p pin and SCKp pin by using port input mode register 1 (PIM1) and port output mode register 1 (POM1). For V_{IH} and V_{IL}, see the DC characteristics with TTL input buffer selected.
- 2.** CSI01 and CSI11 cannot communicate at different potential.

- Remarks 1.** R_b [Ω]: Communication line (SCKp, SO_p) pull-up resistance, C_b [F]: Communication line (SCKp, SO_p) load capacitance, V_b [V]: Communication line voltage
- 2.** p: CSI number (p = 00, 20), m: Unit number (m = 0, 1), n: Channel number (n = 0)

Simplified SPI (CSI) mode connection diagram (during communication at different potential)



**Simplified SPI (CSI) mode serial transfer timing (master mode) (during communication at different potential)
(When DAPmn = 0 and CKPmn = 0, or DAPmn = 1 and CKPmn = 1)**



**Simplified SPI (CSI) mode serial transfer timing (master mode) (during communication at different potential)
(When DAPmn = 0 and CKPmn = 1, or DAPmn = 1 and CKPmn = 0.)**



Remark p: CSI number (p = 00, 20), m: Unit number (m = 0, 1), n: Channel number (n = 0)

(7) Communication at different potential (1.8 V, 2.5 V, 3 V) (simplified SPI (CSI) mode) (slave mode, SCKp... external clock input)**(T_A = -40 to +105°C, 2.4 V ≤ V_{DD} ≤ 5.5 V, V_{SS} = 0 V)**

Parameter	Symbol	Conditions		HS (high-speed main) Mode		Unit
				MIN.	MAX.	
SCKp cycle time ^{Note 1}	t _{KCY2}	4.0 V ≤ V _{DD} ≤ 5.5 V, 2.7 V ≤ V _b ≤ 4.0 V	20 MHz < f _{MCK} ≤ 24 MHz	24/f _{MCK}		ns
			8 MHz < f _{MCK} ≤ 20 MHz	20/f _{MCK}		ns
			4 MHz < f _{MCK} ≤ 8 MHz	16/f _{MCK}		ns
			f _{MCK} ≤ 4 MHz	12/f _{MCK}		ns
		2.7 V ≤ V _{DD} < 4.0 V, 2.3 V ≤ V _b ≤ 2.7 V	20 MHz < f _{MCK} ≤ 24 MHz	32/f _{MCK}		ns
			16 MHz < f _{MCK} ≤ 20 MHz	28/f _{MCK}		ns
			8 MHz < f _{MCK} ≤ 16 MHz	24/f _{MCK}		ns
			4 MHz < f _{MCK} ≤ 8 MHz	16/f _{MCK}		ns
		2.4 V ≤ V _{DD} < 3.3 V, 1.6 V ≤ V _b ≤ 2.0 V	f _{MCK} ≤ 4 MHz	12/f _{MCK}		ns
			20 MHz < f _{MCK} ≤ 24 MHz	72/f _{MCK}		ns
			16 MHz < f _{MCK} ≤ 20 MHz	64/f _{MCK}		ns
			8 MHz < f _{MCK} ≤ 16 MHz	52/f _{MCK}		ns
	4 MHz < f _{MCK} ≤ 8 MHz	32/f _{MCK}		ns		
	f _{MCK} ≤ 4 MHz	20/f _{MCK}		ns		
	SCKp high-/low-level width	t _{KH2} , t _{KL2}	4.0 V ≤ V _{DD} ≤ 5.5 V, 2.7 V ≤ V _b ≤ 4.0 V	t _{KCY2} /2 - 24		ns
			2.7 V ≤ V _{DD} < 4.0 V, 2.3 V ≤ V _b ≤ 2.7 V	t _{KCY2} /2 - 36		ns
2.4 V ≤ V _{DD} < 3.3 V, 1.6 V ≤ V _b ≤ 2.0 V			t _{KCY2} /2 - 100		ns	
Slp setup time (to SCKp↑) ^{Note 2}	t _{SIK2}	4.0 V ≤ V _{DD} ≤ 5.5 V, 2.7 V ≤ V _{DD} ≤ 4.0 V	1/f _{MCK} + 40		ns	
		2.7 V ≤ V _{DD} < 4.0 V, 2.3 V ≤ V _b ≤ 2.7 V	1/f _{MCK} + 40		ns	
		2.4 V ≤ V _{DD} < 3.3 V, 1.6 V ≤ V _{DD} ≤ 2.0 V	1/f _{MCK} + 60		ns	
Slp hold time (from SCKp↑) ^{Note 3}	t _{SI2}		1/f _{MCK} + 62		ns	
Delay time from SCKp↓ to SOP output ^{Note 4}	t _{SO2}	4.0 V ≤ V _{DD} ≤ 5.5 V, 2.7 V ≤ V _b ≤ 4.0 V, C _b = 30 pF, R _b = 1.4 kΩ		2/f _{MCK} + 240	ns	
		2.7 V ≤ V _{DD} < 4.0 V, 2.3 V ≤ V _b ≤ 2.7 V, C _b = 30 pF, R _b = 2.7 kΩ		2/f _{MCK} + 428	ns	
		2.4 V ≤ V _{DD} < 3.3 V, 1.6 V ≤ V _b ≤ 2.0 V, C _b = 30 pF, R _b = 5.5 kΩ		2/f _{MCK} + 1146	ns	

Notes 1. Transfer rate in the SNOOZE mode: MAX. 1 Mbps**2.** When DAPmn = 0 and CKPmn = 0, or DAPmn = 1 and CKPmn = 1. The Slp setup time becomes “to SCKp↓” when DAPmn = 0 and CKPmn = 1, or DAPmn = 1 and CKPmn = 0.**3.** When DAPmn = 0 and CKPmn = 0, or DAPmn = 1 and CKPmn = 1. The Slp hold time becomes “from SCKp↓” when DAPmn = 0 and CKPmn = 1, or DAPmn = 1 and CKPmn = 0.**4.** When DAPmn = 0 and CKPmn = 0, or DAPmn = 1 and CKPmn = 1. The delay time to SOP output becomes “from SCKp↑” when DAPmn = 0 and CKPmn = 1, or DAPmn = 1 and CKPmn = 0.**Cautions 1.** Select the TTL input buffer for the Slp and SCKp pins and the N-ch open drain output (V_{DD} tolerance) mode for the SOP pin by using port input mode register 1 (PIM1) and port output mode register 1 (POM1). For V_{IH} and V_{IL}, see the DC characteristics with TTL input buffer selected.**2.** CSI01 and CSI11 cannot communicate at different potential.

Simplified SPI (CSI) mode connection diagram (during communication at different potential)



**Simplified SPI (CSI) mode serial transfer timing (slave mode) (during communication at different potential)
(When DAPmn = 0 and CKPmn = 0, or DAPmn = 1 and CKPmn = 1.)**



- Remarks**
1. R_b [Ω]: Communication line (SO_p) pull-up resistance, C_b [F]: Communication line (SO_p) load capacitance, V_b [V]: Communication line voltage
 2. p: CSI number (p = 00, 20), m: Unit number (m = 0, 1), n: Channel number (n = 0)
 3. f_{MCK} : Serial array unit operation clock frequency
(Operation clock to be set by the serial clock select register m (SPSm) and the CKSmn bit of serial mode register mn (SMRmn))

**Simplified SPI (CSI) mode serial transfer timing (slave mode) (during communication at different potential)
(When $\text{DAPmn} = 0$ and $\text{CKPmn} = 1$, or $\text{DAPmn} = 1$ and $\text{CKPmn} = 0$.)**



Remark p: CSI number (p = 00, 20), m: Unit number (m = 0, 1), n: Channel number (n = 0)

(8) Communication at different potential (1.8 V, 2.5 V, 3 V) (simplified I²C mode)**($T_A = -40$ to $+105^\circ\text{C}$, $2.4\text{ V} \leq V_{DD} \leq 5.5\text{ V}$, $V_{SS} = 0\text{ V}$)**

Parameter	Symbol	Conditions	HS (high-speed main) Mode		Unit
			MIN.	MAX.	
SCLr clock frequency	f _{SCL}	4.0 V ≤ V _{DD} ≤ 5.5 V, 2.7 V ≤ V _b ≤ 4.0 V, C _b = 100 pF, R _b = 2.8 kΩ		100 ^{Note1}	kHz
		2.7 V ≤ V _{DD} < 4.0 V, 2.3 V ≤ V _b ≤ 2.7 V, C _b = 100 pF, R _b = 2.7 kΩ		100 ^{Note1}	
		2.4 V ≤ V _{DD} < 3.3 V, 1.6 V ≤ V _b ≤ 2.0 V, C _b = 100 pF, R _b = 5.5 kΩ		100 ^{Note1}	
Hold time when SCLr = "L"	t _{LOW}	4.0 V ≤ V _{DD} ≤ 5.5 V, 2.7 V ≤ V _b ≤ 4.0 V, C _b = 100 pF, R _b = 2.8 kΩ	4600		ns
		2.7 V ≤ V _{DD} < 4.0 V, 2.3 V ≤ V _b ≤ 2.7 V, C _b = 100 pF, R _b = 2.7 kΩ	4600		
		2.4 V ≤ V _{DD} < 3.3 V, 1.6 V ≤ V _b ≤ 2.0 V, C _b = 100 pF, R _b = 5.5 kΩ	4650		
Hold time when SCLr = "H"	t _{HIGH}	4.0 V ≤ V _{DD} ≤ 5.5 V, 2.7 V ≤ V _b ≤ 4.0 V, C _b = 100 pF, R _b = 2.8 kΩ	2700		ns
		2.7 V ≤ V _{DD} < 4.0 V, 2.3 V ≤ V _b ≤ 2.7 V, C _b = 100 pF, R _b = 2.7 kΩ	2400		
		2.4 V ≤ V _{DD} < 3.3 V, 1.6 V ≤ V _b ≤ 2.0 V, C _b = 100 pF, R _b = 5.5 kΩ	1830		
Data setup time (reception)	t _{SU:DAT}	4.0 V ≤ V _{DD} ≤ 5.5 V, 2.7 V ≤ V _b ≤ 4.0 V, C _b = 100 pF, R _b = 2.8 kΩ	1/f _{MCK} + 760 ^{Note2}		ns
		2.7 V ≤ V _{DD} < 4.0 V, 2.3 V ≤ V _b ≤ 2.7 V, C _b = 100 pF, R _b = 2.7 kΩ	1/f _{MCK} + 760 ^{Note2}		
		2.4 V ≤ V _{DD} < 3.3 V, 1.6 V ≤ V _b ≤ 2.0 V, C _b = 100 pF, R _b = 5.5 kΩ	1/f _{MCK} + 570 ^{Note2}		
Data hold time (transmission)	t _{HD:DAT}	4.0 V ≤ V _{DD} ≤ 5.5 V, 2.7 V ≤ V _b ≤ 4.0 V, C _b = 100 pF, R _b = 2.8 kΩ	0	1420	ns
		2.7 V ≤ V _{DD} < 4.0 V, 2.3 V ≤ V _b ≤ 2.7 V, C _b = 100 pF, R _b = 2.7 kΩ	0	1420	
		2.4 V ≤ V _{DD} < 3.3 V, 1.6 V ≤ V _b ≤ 2.0 V, C _b = 100 pF, R _b = 5.5 kΩ	0	1215	

Notes 1. The value must be equal to or less than f_{MCK}/4.

2. Set t_{SU:DAT} so that it will not exceed the hold time when SCLr = "L" or SCLr = "H".

Cautions 1. Select the TTL input buffer and the N-ch open drain output (V_{DD} tolerance) mode for the SDAr pin and the N-ch open drain output (V_{DD} tolerance) mode for the SCLr pin by using port input mode register 1 (PIM1) and port output mode register 1 (POM1). For V_{IH} and V_{IL}, see the DC characteristics with TTL input buffer selected.

2. IIC01 and IIC11 cannot communicate at different potential.

(Remarks are listed on the next page.)

Simplified I²C mode connection diagram (during communication at different potential)



Simplified I²C mode serial transfer timing (during communication at different potential)

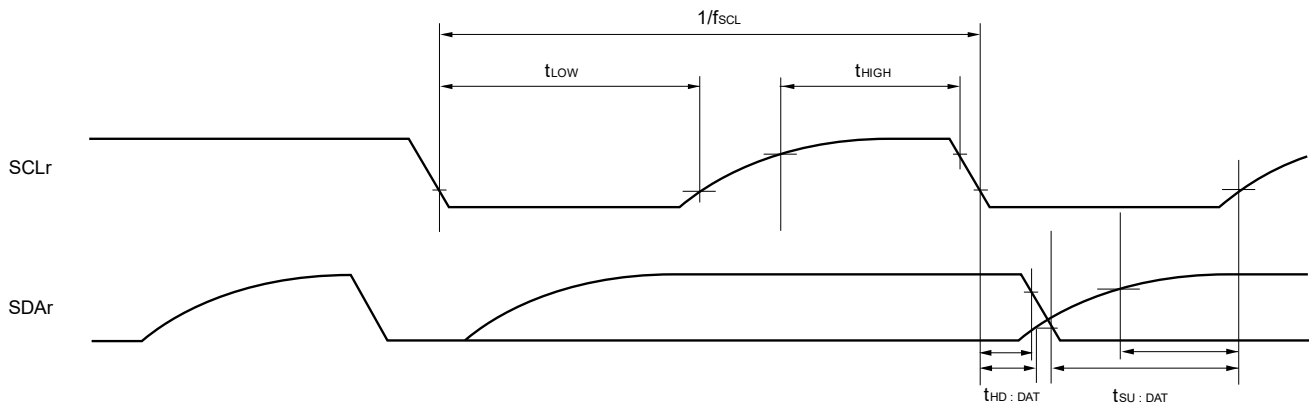

- Remarks 1.** R_b [Ω]: Communication line (SDAr, SCLr) pull-up resistance, C_b [F]: Communication line (SDAr, SCLr) load capacitance, V_b [V]: Communication line voltage
- 2.** r: IIC Number (r = 00, 20)
- 3.** f_{MCK} : Serial array unit operation clock frequency
 (Operation clock to be set by the serial clock select register m (SPSm) and the CKSmn bit of serial mode register mn (SMRmn).
 m: Unit number (m = 0,1), n: Channel number (n = 0))

3.5.2 Serial interface IICA

(T_A = -40 to +105°C, 2.4 V ≤ V_{DD} ≤ 5.5 V, V_{SS} = 0 V)

Parameter	Symbol	Conditions	HS (high-speed main) mode				Unit
			Standard Mode		Fast Mode		
			MIN.	MAX.	MIN.	MAX.	
SCLA0 clock frequency	f _{SCL}	Fast mode: f _{CLK} ≥ 3.5 MHz			0	400	kHz
		Normal mode: f _{CLK} ≥ 1 MHz	0	100			
Setup time of restart condition	t _{SU:STA}		4.7		0.6		μs
Hold time ^{Note 1}	t _{HD:STA}		4.0		0.6		μs
Hold time when SCLA0 = "L"	t _{LOW}		4.7		1.3		μs
Hold time when SCLA0 = "H"	t _{HIGH}		4.0		0.6		μs
Data setup time (reception)	t _{SU:DAT}		250		100		ns
Data hold time (transmission) ^{Note 2}	t _{HD:DAT}		0	3.45	0	0.9	μs
Setup time of stop condition	t _{SU:STO}		4.0		0.6		μs
Bus-free time	t _{BUF}		4.7		1.3		μs

- Notes**
- The first clock pulse is generated after this period when the start/restart condition is detected.
 - The maximum value (MAX.) of t_{HD:DAT} is during normal transfer and a clock stretch state is inserted in the ACK (acknowledge) timing.

Caution Only in the 30-pin products, the values in the above table are applied even when bit 2 (PIOR2) in the peripheral I/O redirection register (PIOR) is 1. At this time, the pin characteristics (I_{OH1}, I_{OL1}, V_{OH1}, V_{OL1}) must satisfy the values in the redirect destination.

Remark The maximum value of C_b (communication line capacitance) and the value of R_b (communication line pull-up resistor) at that time in each mode are as follows.

Normal mode: C_b = 400 pF, R_b = 2.7 kΩ
 Fast mode: C_b = 320 pF, R_b = 1.1 kΩ

IICA serial transfer timing

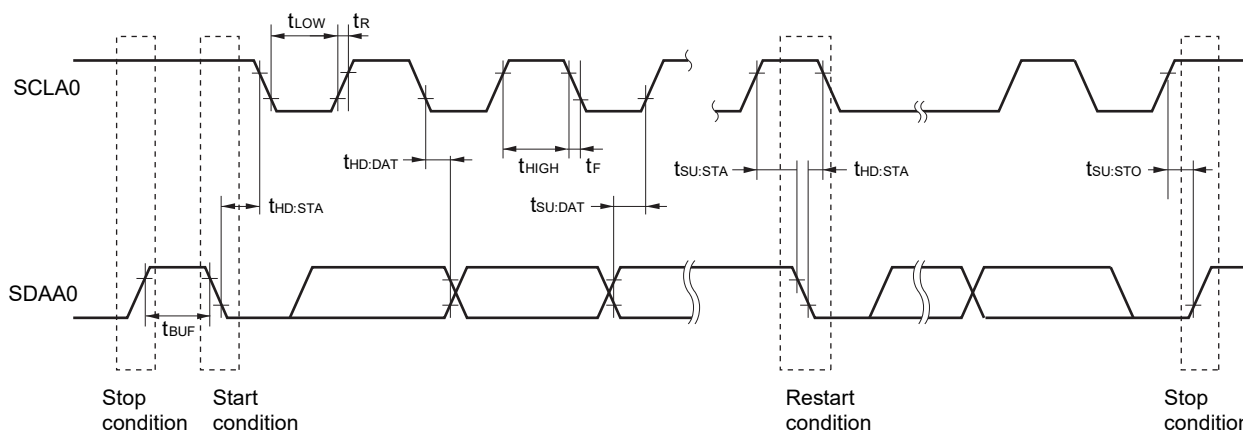

3.6 Analog Characteristics

3.6.1 A/D converter characteristics

Classification of A/D converter characteristics

Input channel	Reference Voltage		
	Reference voltage (+) = AV_{REFP} Reference voltage (-) = AV_{REFM}	Reference voltage (+) = V_{DD} Reference voltage (-) = V_{SS}	Reference voltage (+) = V_{BGR} Reference voltage (-) = AV_{REFM}
ANI0 to ANI3	Refer to 3.6.1 (1) .	Refer to 3.6.1 (3) .	Refer to 3.6.1 (4) .
ANI16 to ANI22	Refer to 3.6.1 (2) .		
Internal reference voltage Temperature sensor output voltage	Refer to 3.6.1 (1) .		–

(1) When reference voltage (+) = $AV_{REFP}/ANI0$ ($ADREFP1 = 0$, $ADREFP0 = 1$), reference voltage (-) = $AV_{REFM}/ANI1$ ($ADREFM = 1$), target pin: ANI2, ANI3, internal reference voltage, and temperature sensor output voltage

($T_A = -40$ to $+105^\circ\text{C}$, $2.4\text{ V} \leq AV_{REFP} \leq V_{DD} \leq 5.5\text{ V}$, $V_{SS} = 0\text{ V}$, Reference voltage (+) = AV_{REFP} , Reference voltage (-) = $AV_{REFM} = 0\text{ V}$)

Parameter	Symbol	Conditions	MIN.	TYP.	MAX.	Unit
Resolution	RES		8		10	bit
Overall error ^{Note 1}	AINL	10-bit resolution $AV_{REFP} = V_{DD}$ ^{Note 3}		1.2	± 3.5	LSB
Conversion time	t_{CONV}	10-bit resolution Target pin: ANI2, ANI3	$3.6\text{ V} \leq V_{DD} \leq 5.5\text{ V}$	2.125	39	μs
			$2.7\text{ V} \leq V_{DD} \leq 5.5\text{ V}$	3.1875	39	μs
			$2.4\text{ V} \leq V_{DD} \leq 5.5\text{ V}$	17	39	μs
		10-bit resolution Target pin: Internal reference voltage, and temperature sensor output voltage (HS (high-speed main) mode)	$3.6\text{ V} \leq V_{DD} \leq 5.5\text{ V}$	2.375	39	μs
			$2.7\text{ V} \leq V_{DD} \leq 5.5\text{ V}$	3.5625	39	μs
			$2.4\text{ V} \leq V_{DD} \leq 5.5\text{ V}$	17	39	μs
Zero-scale error ^{Notes 1, 2}	EZS	10-bit resolution $AV_{REFP} = V_{DD}$ ^{Note 3}			± 0.25	%FSR
Full-scale error ^{Notes 1, 2}	EFS	10-bit resolution $AV_{REFP} = V_{DD}$ ^{Note 3}			± 0.25	%FSR
Integral linearity error ^{Note 1}	ILE	10-bit resolution $AV_{REFP} = V_{DD}$ ^{Note 3}			± 2.5	LSB
Differential linearity error ^{Note 1}	DLE	10-bit resolution $AV_{REFP} = V_{DD}$ ^{Note 3}			± 1.5	LSB
Analog input voltage	V_{AIN}	ANI2, ANI3	0		AV_{REFP}	V
		Internal reference voltage (HS (high-speed main) mode)		V_{BGR} ^{Note 4}		V
		Temperature sensor output voltage (HS (high-speed main) mode)		V_{TMPS25} ^{Note 4}		V

(Notes are listed on the next page.)

- Notes**
1. Excludes quantization error ($\pm 1/2$ LSB).
 2. This value is indicated as a ratio (%FSR) to the full-scale value.
 3. When $AV_{REFP} < V_{DD}$, the MAX. values are as follows.
 Overall error: Add ± 1.0 LSB to the MAX. value when $AV_{REFP} = V_{DD}$.
 Zero-scale error/Full-scale error: Add $\pm 0.05\%$ FSR to the MAX. value when $AV_{REFP} = V_{DD}$.
 Integral linearity error/ Differential linearity error: Add ± 0.5 LSB to the MAX. value when $AV_{REFP} = V_{DD}$.
 4. Refer to **3.6.2 Temperature sensor/internal reference voltage characteristics**.

(2) When reference voltage (+) = $AV_{REFP}/ANI0$ (ADREFP1 = 0, ADREFP0 = 1), reference voltage (-) = $AV_{REFM}/ANI1$ (ADREFM = 1), target pin: ANI16 to ANI22

($T_A = -40$ to $+105^\circ\text{C}$, $2.4\text{ V} \leq AV_{REFP} \leq V_{DD} \leq 5.5\text{ V}$, $V_{SS} = 0\text{ V}$, Reference voltage (+) = AV_{REFP} , Reference voltage (-) = $AV_{REFM} = 0\text{ V}$)

Parameter	Symbol	Conditions	MIN.	TYP.	MAX.	Unit
Resolution	R_{ES}		8		10	bit
Overall error ^{Note 1}	A _{INL}	10-bit resolution $AV_{REFP} = V_{DD}$ ^{Note 3}		1.2	± 5.0	LSB
Conversion time	t_{CONV}	10-bit resolution Target ANI pin: ANI16 to ANI22	$3.6\text{ V} \leq V_{DD} \leq 5.5\text{ V}$	2.125	39	μs
			$2.7\text{ V} \leq V_{DD} \leq 5.5\text{ V}$	3.1875	39	μs
			$2.4\text{ V} \leq V_{DD} \leq 5.5\text{ V}$	17	39	μs
Zero-scale error ^{Notes 1, 2}	E _{ZS}	10-bit resolution $AV_{REFP} = V_{DD}$ ^{Note 3}			± 0.35	%FSR
Full-scale error ^{Notes 1, 2}	E _{FS}	10-bit resolution $AV_{REFP} = V_{DD}$ ^{Note 3}			± 0.35	%FSR
Integral linearity error ^{Note 1}	I _{LE}	10-bit resolution $AV_{REFP} = V_{DD}$ ^{Note 3}			± 3.5	LSB
Differential linearity error ^{Note 1}	D _{LE}	10-bit resolution $AV_{REFP} = V_{DD}$ ^{Note 3}			± 2.0	LSB
Analog input voltage	V_{AIN}	ANI16 to ANI22	0		AV_{REFP} and V_{DD}	V

- Notes**
1. Excludes quantization error ($\pm 1/2$ LSB).
 2. This value is indicated as a ratio (%FSR) to the full-scale value.
 3. When $AV_{REFP} \leq V_{DD}$, the MAX. values are as follows.
 Overall error: Add ± 4.0 LSB to the MAX. value when $AV_{REFP} = V_{DD}$.
 Zero-scale error/Full-scale error: Add $\pm 0.20\%$ FSR to the MAX. value when $AV_{REFP} = V_{DD}$.
 Integral linearity error/ Differential linearity error: Add ± 2.0 LSB to the MAX. value when $AV_{REFP} = V_{DD}$.

(3) When reference voltage (+) = V_{DD} (ADREFP1 = 0, ADREFP0 = 0), reference voltage (-) = V_{SS} (ADREFM = 0), target pin: ANI0 to ANI3, ANI16 to ANI22, internal reference voltage, and temperature sensor output voltage

($T_A = -40$ to $+105^\circ\text{C}$, $2.4\text{ V} \leq V_{DD} \leq 5.5\text{ V}$, $V_{SS} = 0\text{ V}$, Reference voltage (+) = V_{DD} , Reference voltage (-) = V_{SS})

Parameter	Symbol	Conditions	MIN.	TYP.	MAX.	Unit	
Resolution	R_{ES}		8		10	bit	
Overall error ^{Note 1}	A_{INL}	10-bit resolution		1.2	± 7.0	LSB	
Conversion time	t_{CONV}	10-bit resolution Target pin: ANI0 to ANI3, ANI16 to ANI22	$3.6\text{ V} \leq V_{DD} \leq 5.5\text{ V}$	2.125		39	μs
			$2.7\text{ V} \leq V_{DD} \leq 5.5\text{ V}$	3.1875		39	μs
			$2.4\text{ V} \leq V_{DD} \leq 5.5\text{ V}$	17		39	μs
Conversion time	t_{CONV}	10-bit resolution Target pin: internal reference voltage, and temperature sensor output voltage (HS (high-speed main) mode)	$3.6\text{ V} \leq V_{DD} \leq 5.5\text{ V}$	2.375		39	μs
			$2.7\text{ V} \leq V_{DD} \leq 5.5\text{ V}$	3.5625		39	μs
			$2.4\text{ V} \leq V_{DD} \leq 5.5\text{ V}$	17		39	μs
Zero-scale error ^{Notes 1, 2}	E_{ZS}	10-bit resolution			± 0.60	%FSR	
Full-scale error ^{Notes 1, 2}	E_{FS}	10-bit resolution			± 0.60	%FSR	
Integral linearity error ^{Note 1}	I_{LE}	10-bit resolution			± 4.0	LSB	
Differential linearity error ^{Note 1}	D_{LE}	10-bit resolution			± 2.0	LSB	
Analog input voltage	V_{AIN}	ANI0 to ANI3, ANI16 to ANI22	0		V_{DD}	V	
		Internal reference voltage (HS (high-speed main) mode)	V_{BGR} ^{Note 3}			V	
		Temperature sensor output voltage (HS (high-speed main) mode)	V_{TMPS25} ^{Note 3}			V	

Notes 1. Excludes quantization error ($\pm 1/2$ LSB).

2. This value is indicated as a ratio (%FSR) to the full-scale value.

3. Refer to **3.6.2 Temperature sensor/internal reference voltage characteristics**.

(4) When reference voltage (+) = Internal reference voltage (ADREFP1 = 1, ADREFP0 = 0), reference voltage (-) = AV_{REFM} (ADREFM = 1), target pin: ANI0, ANI2, ANI3, and ANI16 to ANI22

($T_A = -40$ to $+105^\circ\text{C}$, $2.4\text{ V} \leq V_{DD} \leq 5.5\text{ V}$, $V_{SS} = 0\text{ V}$, Reference voltage (+) = V_{BGR} ^{Note 3}, Reference voltage (-) = AV_{REFM} ^{Note 4} = 0 V, HS (high-speed main) mode)

Parameter	Symbol	Conditions	MIN.	TYP.	MAX.	Unit
Resolution	R_{ES}		8			bit
Conversion time	t_{CONV}	8-bit resolution	17		39	μs
Zero-scale error ^{Notes 1, 2}	EZS	8-bit resolution			± 0.60	%FSR
Integral linearity error ^{Note 1}	ILE	8-bit resolution			± 2.0	LSB
Differential linearity error ^{Note 1}	DLE	8-bit resolution			± 1.0	LSB
Analog input voltage	V_{AIN}		0		V_{BGR} ^{Note 3}	V

Notes 1. Excludes quantization error ($\pm 1/2$ LSB).

2. This value is indicated as a ratio (%FSR) to the full-scale value.

3. Refer to **3.6.2 Temperature sensor/internal reference voltage characteristics**.

4. When reference voltage (-) = V_{SS} , the MAX. values are as follows.

Zero-scale error: Add $\pm 0.35\%$ FSR to the MAX. value when reference voltage (-) = AV_{REFM} .

Integral linearity error: Add ± 0.5 LSB to the MAX. value when reference voltage (-) = AV_{REFM} .

Differential linearity error: Add ± 0.2 LSB to the MAX. value when reference voltage (-) = AV_{REFM} .

3.6.2 Temperature sensor/internal reference voltage characteristics

($T_A = -40$ to $+105^\circ\text{C}$, $2.4\text{ V} \leq V_{DD} \leq 5.5\text{ V}$, $V_{SS} = 0\text{ V}$, HS (high-speed main) mode)

Parameter	Symbol	Conditions	MIN.	TYP.	MAX.	Unit
Temperature sensor output voltage	V_{TMS25}	Setting ADS register = 80H, $T_A = +25^\circ\text{C}$		1.05		V
Internal reference voltage	V_{BGR}	Setting ADS register = 81H	1.38	1.45	1.50	V
Temperature coefficient	F_{VTMS}	Temperature sensor output voltage that depends on the temperature		-3.6		mV/ $^\circ\text{C}$
Operation stabilization wait time	t_{AMP}		5			μs

3.6.3 POR circuit characteristics

($T_A = -40$ to $+105^\circ\text{C}$, $V_{SS} = 0\text{ V}$)

Parameter	Symbol	Conditions	MIN.	TYP.	MAX.	Unit
Detection voltage	V_{POR}	The power supply voltage is rising.	1.45	1.51	1.57	V
	V_{PDR}	The power supply voltage is falling.	1.44	1.50	1.56	V
Minimum pulse width ^{Note}	T_{PW}		300			μs

Note Minimum time required for a POR reset when V_{DD} exceeds below V_{PDR} . This is also the minimum time required for a POR reset from when V_{DD} exceeds below 0.7 V to when V_{DD} exceeds V_{POR} while STOP mode is entered or the main system clock is stopped through setting bit 0 (HIOSTOP) and bit 7 (MSTOP) in the clock operation status control register (CSC).



3.6.4 LVD circuit characteristics

LVD Detection Voltage of Reset Mode and Interrupt Mode

 $(T_A = -40$ to $+105^\circ\text{C}$, $V_{PDR} \leq V_{DD} \leq 5.5$ V, $V_{SS} = 0$ V)

Parameter	Symbol	Conditions	MIN.	TYP.	MAX.	Unit
Detection supply voltage	V _{LVD0}	The power supply voltage is rising.	3.90	4.06	4.22	V
		The power supply voltage is falling.	3.83	3.98	4.13	V
	V _{LVD1}	The power supply voltage is rising.	3.60	3.75	3.90	V
		The power supply voltage is falling.	3.53	3.67	3.81	V
	V _{LVD2}	The power supply voltage is rising.	3.01	3.13	3.25	V
		The power supply voltage is falling.	2.94	3.06	3.18	V
	V _{LVD3}	The power supply voltage is rising.	2.90	3.02	3.14	V
		The power supply voltage is falling.	2.85	2.96	3.07	V
	V _{LVD4}	The power supply voltage is rising.	2.81	2.92	3.03	V
		The power supply voltage is falling.	2.75	2.86	2.97	V
	V _{LVD5}	The power supply voltage is rising.	2.70	2.81	2.92	V
		The power supply voltage is falling.	2.64	2.75	2.86	V
	V _{LVD6}	The power supply voltage is rising.	2.61	2.71	2.81	V
		The power supply voltage is falling.	2.55	2.65	2.75	V
V _{LVD7}	The power supply voltage is rising.	2.51	2.61	2.71	V	
	The power supply voltage is falling.	2.45	2.55	2.65	V	
Minimum pulse width	t _{LW}		300			μs
Detection delay time					300	μs

LVD detection voltage of interrupt & reset mode**($T_A = -40$ to $+105^\circ\text{C}$, $V_{PDR} \leq V_{DD} \leq 5.5$ V, $V_{SS} = 0$ V)**

Parameter	Symbol	Conditions	MIN.	TYP.	MAX.	Unit	
Interrupt and reset mode	V_{LVDD0}	$V_{POC2}, V_{POC1}, V_{POC1} = 0, 1, 1$, falling reset voltage	2.64	2.75	2.86	V	
	V_{LVDD1}	LVIS1, LVIS0 = 1, 0	Rising reset release voltage	2.81	2.92	3.03	V
			Falling interrupt voltage	2.75	2.86	2.97	V
	V_{LVDD2}	LVIS1, LVIS0 = 0, 1	Rising reset release voltage	2.90	3.02	3.14	V
			Falling interrupt voltage	2.85	2.96	3.07	V
	V_{LVDD3}	LVIS1, LVIS0 = 0, 0	Rising reset release voltage	3.90	4.06	4.22	V
Falling interrupt voltage			3.83	3.98	4.13	V	

3.6.5 Power supply voltage rising slope characteristics**($T_A = -40$ to $+105^\circ\text{C}$, $V_{SS} = 0$ V)**

Parameter	Symbol	Conditions	MIN.	TYP.	MAX.	Unit
Power supply voltage rising slope	S_{VDD}				54	V/ms

Caution Make sure to keep the internal reset state by the LVD circuit or an external reset until V_{DD} reaches the operating voltage range shown in 3.4 AC Characteristics.

3.7 RAM Data Retention Characteristics

($T_A = -40$ to $+105^\circ\text{C}$, $V_{SS} = 0$ V)

Parameter	Symbol	Conditions	MIN.	TYP.	MAX.	Unit
Data retention supply voltage	V_{DDDR}		1.44 <small>Note</small>		5.5	V

Note This depends on the POR detection voltage. For a falling voltage, data in RAM are retained until the voltage reaches the level that triggers a POR reset but not once it reaches the level at which a POR reset is generated.



3.8 Flash Memory Programming Characteristics

($T_A = -40$ to $+105^\circ\text{C}$, 2.4 V $\leq V_{DD} \leq 5.5$ V, $V_{SS} = 0$ V)

Parameter	Symbol	Conditions	MIN.	TYP.	MAX.	Unit
System clock frequency	f_{CLK}		1		24	MHz
Code flash memory rewritable times <small>Notes 1, 2, 3</small>	C_{erwr}	Retained for 20 years $T_A = 85^\circ\text{C}$ <small>Note 4</small>	1,000			Times
Data flash memory rewritable times <small>Notes 1, 2, 3</small>		Retained for 1 year $T_A = 25^\circ\text{C}$		1,000,000		
		Retained for 5 years $T_A = 85^\circ\text{C}$ <small>Note 4</small>	100,000			
		Retained for 20 years $T_A = 85^\circ\text{C}$ <small>Note 4</small>	10,000			

- Notes**
- 1 erase + 1 write after the erase is regarded as 1 rewrite. The retaining years are until next rewrite after the rewrite.
 2. When using flash memory programmer and Renesas Electronics self programming library
 3. These are the characteristics of the flash memory and the results obtained from reliability testing by Renesas Electronics Corporation.
 4. This temperature is the average value at which data are retained.

3.9 Dedicated Flash Memory Programmer Communication (UART)

(T_A = -40 to +105°C, 2.4 V ≤ V_{DD} ≤ 5.5 V, V_{SS} = 0 V)

Parameter	Symbol	Conditions	MIN.	TYP.	MAX.	Unit
Transfer rate		During serial programming	115,200		1,000,000	bps

3.10 Timing of Entry to Flash Memory Programming Modes

(T_A = -40 to +105°C, 2.4 V ≤ V_{DD} ≤ 5.5 V, V_{SS} = 0 V)

Parameter	Symbol	Conditions	MIN.	TYP.	MAX.	Unit
Time to complete the communication for the initial setting after the external reset is released	t _{SUINIT}	POR and LVD reset are released before external release			100	ms
Time to release the external reset after the TOOL0 pin is set to the low level	t _{SU}	POR and LVD reset are released before external release	10			μs
Time to hold the TOOL0 pin at the low level after the external reset is released (excluding the processing time of the firmware to control the flash memory)	t _{HD}	POR and LVD reset are released before external release	1			ms

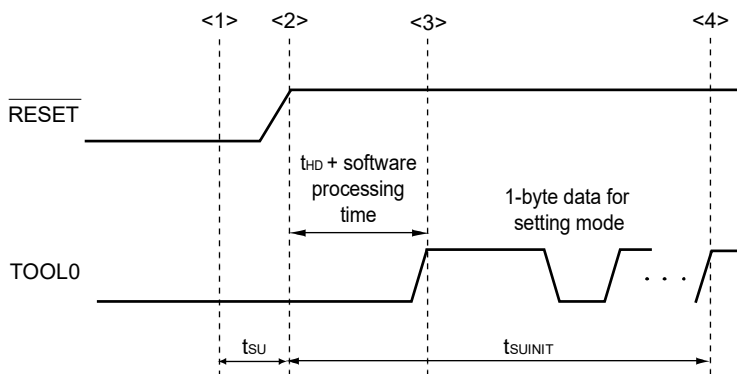

- <1> The low level is input to the TOOL0 pin.
- <2> The external reset is released (POR and LVD reset must be released before the external reset is released.).
- <3> The TOOL0 pin is set to the high level.
- <4> Setting of the flash memory programming mode by UART reception and complete the baud rate setting.

Remark t_{SUINIT}: Communication for the initial setting must be completed within 100 ms after the external reset is released during this period.

t_{SU}: Time to release the external reset after the TOOL0 pin is set to the low level

t_{HD}: Time to hold the TOOL0 pin at the low level after the external reset is released (excluding the processing time of the firmware to control the flash memory)

4. PACKAGE DRAWINGS

4.1 20-pin package

JEITA Package Code	RENESAS Code	Previous Code	MASS (TYP.) [g]
P-LSSOP20-4.4x6.5-0.65	PLSP0020JB-A	P20MA-65-NAA-1	0.1

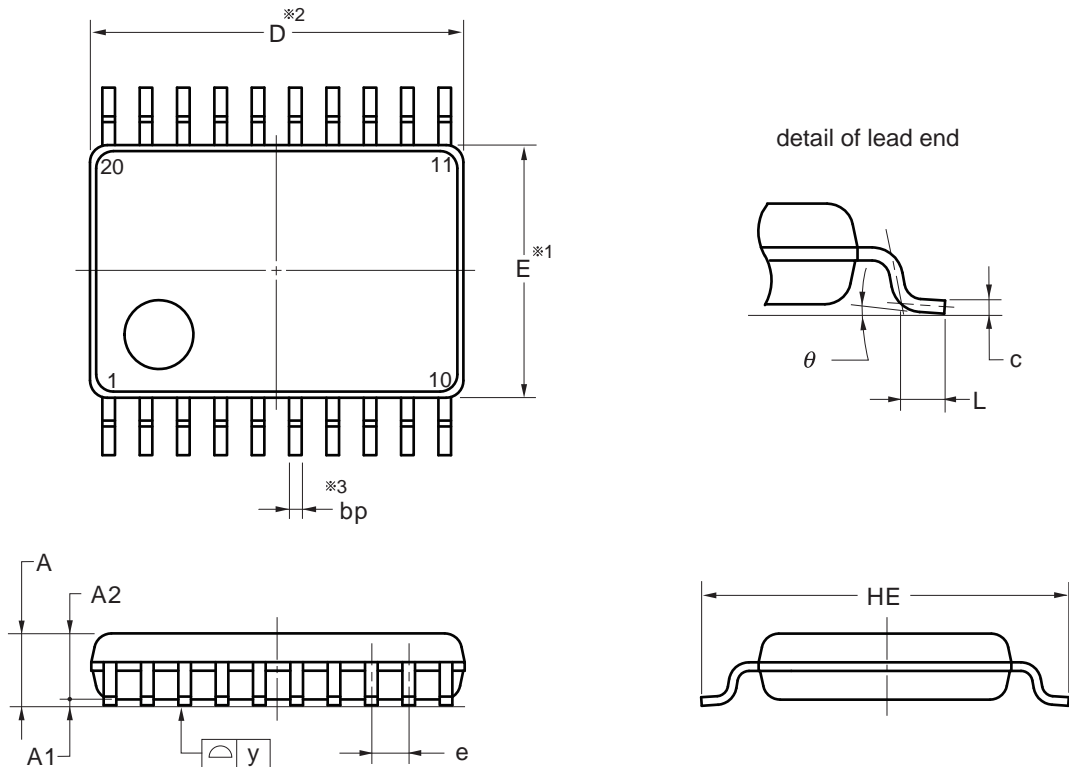

NOTE

- 1. Dimensions "※1" and "※2" do not include mold flash.
- 2. Dimension "※3" does not include trim offset.

(UNIT:mm)

ITEM	DIMENSIONS
D	6.50±0.10
E	4.40±0.10
HE	6.40±0.20
A	1.45 MAX.
A1	0.10±0.10
A2	1.15
e	0.65±0.12
bp	0.22 $^{+0.10}_{-0.05}$
c	0.15 $^{+0.05}_{-0.02}$
L	0.50±0.20
y	0.10
θ	0° to 10°

©2012 Renesas Electronics Corporation. All rights reserved.

JEITA Package code	RENESAS code	MASS(TYP.)[g]
P-TSSOP20-4.40x6.50-0.65	PTSP0020JI-A	0.08



NOTES:
 1. DIMENSION 'D' AND 'E1' DOES NOT INCLUDE MOLD FLASH.
 2. DIMENSION 'b' DOES NOT INCLUDE TRIM OFFSET.
 3. DIMENSION 'D' AND 'E1' TO BE DETERMINED AT DATUM PLANE [A].

Reference Symbol	Dimension in Millimeters		
	Min.	Nom.	Max.
A	-	-	1.20
A1	0.05	-	0.15
A2	0.80	1.00	1.05
b	0.19	-	0.30
C	0.09	0.127	0.20
D	6.40	6.50	6.60
E1	4.30	4.40	4.50
E	6.40 BSC		
e	0.65 BSC		
L1	1.00 REF		
L	0.50	0.60	0.75
S	0.20	-	-
θ	0°	-	8°
aaa	0.10		
bbb	0.10		
ccc	0.05		
ddd	0.20		

4.2 24-pin package

JEITA Package Code	RENESAS Code	Previous Code	MASS (TYP.) [g]
P-HWQFN24-4x4-0.50	PWQN0024KE-A	P24K8-50-CAB-1	0.04



(UNIT:mm)

ITEM	DIMENSIONS
D	4.00±0.05
E	4.00±0.05
A	0.75±0.05
b	0.25 ^{+0.05} _{-0.07}
e	0.50
Lp	0.40±0.10
x	0.05
y	0.05

ITEM		D2			E2		
		MIN	NOM	MAX	MIN	NOM	MAX
EXPOSED DIE PAD VARIATIONS	A	2.45	2.50	2.55	2.45	2.50	2.55

©2012 Renesas Electronics Corporation. All rights reserved.

JEITA Package code	RENESAS code	MASS(TYP.)[g]
P-HWQFN024-4x4-0.50	PWQN0024KF-A	0.04

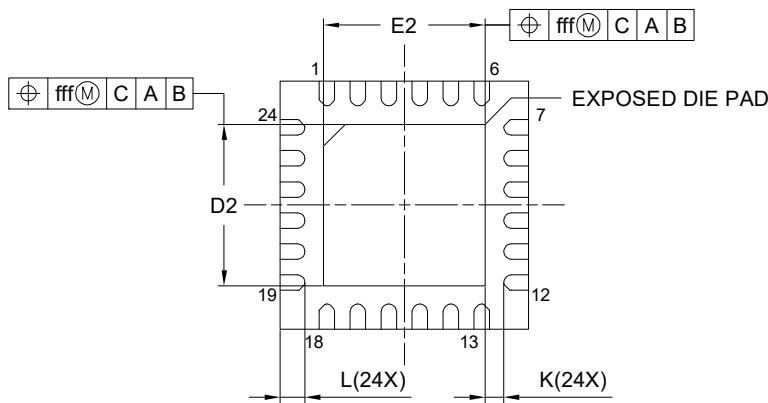

Reference Symbol	Dimension in Millimeters		
	Min.	Nom.	Max.
A	-	-	0.80
A1	0.00	0.02	0.05
A3	0.203 REF.		
b	0.18	0.25	0.30
D	4.00 BSC		
E	4.00 BSC		
e	0.50 BSC		
L	0.35	0.40	0.45
K	0.20	-	-
D2	2.55	2.60	2.65
E2	2.55	2.60	2.65
aaa	0.15		
bbb	0.10		
ccc	0.10		
ddd	0.05		
eee	0.08		
fff	0.10		

JEITA Package Code	RENESAS Code	MASS(Typ.)[g]
P-HWQFN24-4×4-0.50	PWQN0024KH-A	0.04

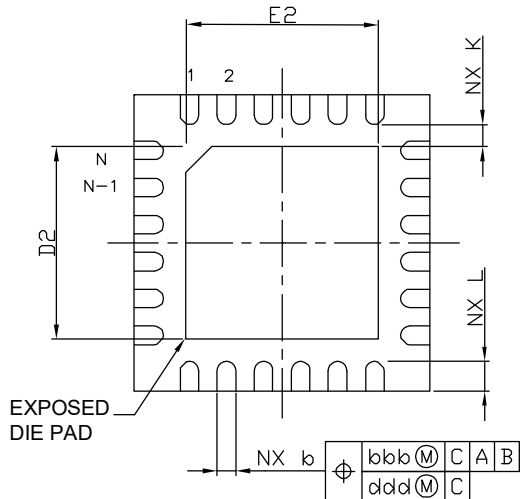
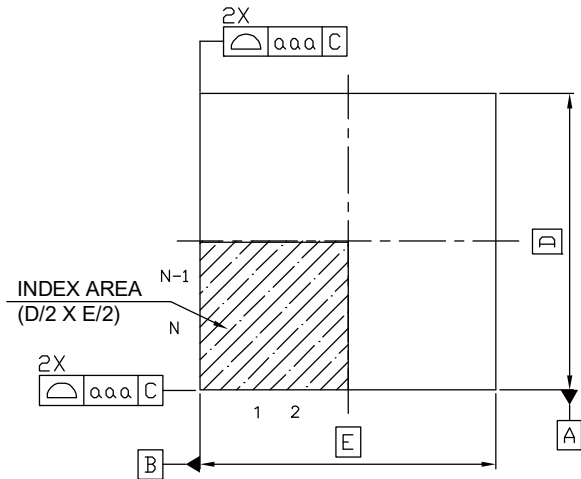

Reference Symbol	Dimension in Millimeters		
	Min.	Nom.	Max.
A	—	—	0.80
A ₁	0.00	—	0.05
A ₃	0.20 REF.		
b	0.20	0.25	0.30
D	—	4.00	—
E	—	4.00	—
e	—	0.50	—
N	24		
L	0.30	0.40	0.50
K	0.20	—	—
D ₂	2.50	2.60	2.70
E ₂	2.50	2.60	2.70
aaa	—	—	0.15
bbb	—	—	0.10
ccc	—	—	0.10
ddd	—	—	0.05
eee	—	—	0.08

4.3 30-pin package

JEITA Package Code	RENESAS Code	Previous Code	MASS (TYP.) [g]
P-LSSOP30-0300-0.65	PLSP0030JB-B	S30MC-65-5A4-3	0.18

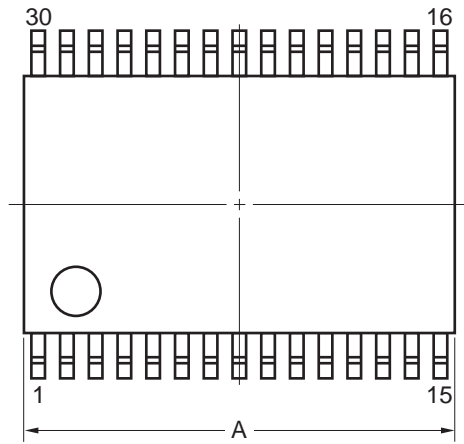

detail of lead end

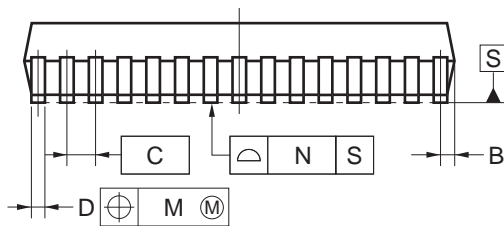

ITEM	MILLIMETERS
A	9.85±0.15
B	0.45 MAX.
C	0.65 (T.P.)
D	0.24 ^{+0.08} _{-0.07}
E	0.1±0.05
F	1.3±0.1
G	1.2
H	8.1±0.2
I	6.1±0.2
J	1.0±0.2
K	0.17±0.03
L	0.5
M	0.13
N	0.10
P	3° ^{+5°} _{-3°}
T	0.25
U	0.6±0.15

NOTE

Each lead centerline is located within 0.13 mm of its true position (T.P.) at maximum material condition.

©2012 Renesas Electronics Corporation. All rights reserved.

Revision History	RL78/G12 Datasheet
-------------------------	---------------------------

Rev.	Date	Description	
		Page	Summary
1.00	Dec 10, 2012	-	First Edition issued
2.00	Sep 06, 2013	1	Modification of 1.1 Features
		3	Modification of 1.2 List of Part Numbers
		4	Modification of Table 1-1. List of Ordering Part Numbers, Note, and Caution
		7 to 9	Modification of package name in 1.4.1 to 1.4.3
		14	Modification of tables in 1.7 Outline of Functions
		17	Modification of description of table in 2.1 Absolute Maximum Ratings ($T_A = 25^\circ\text{C}$)
		18	Modification of table, Note, and Caution in 2.2.1 X1 oscillator characteristics
		18	Modification of table in 2.2.2 On-chip oscillator characteristics
		19	Modification of Note 3 in 2.3.1 Pin characteristics (1/4)
		20	Modification of Note 3 in 2.3.1 Pin characteristics (2/4)
		23	Modification of Notes 1 and 2 in (1) 20-, 24-pin products (1/2)
		24	Modification of Notes 1 and 3 in (1) 20-, 24-pin products (2/2)
		25	Modification of Notes 1 and 2 in (2) 30-pin products (1/2)
		26	Modification of Notes 1 and 3 in (2) 30-pin products (2/2)
		27	Modification of (3) Peripheral functions (Common to all products)
		28	Modification of table in 2.4 AC Characteristics
		29	Addition of Minimum Instruction Execution Time during Main System Clock Operation
		30	Modification of figures of AC Timing Test Point and External Main System Clock Timing
		31	Modification of figure of AC Timing Test Point
		31	Modification of description and Note 2 in (1) During communication at same potential (UART mode)
		32	Modification of description in (2) During communication at same potential (CSI mode)
		33	Modification of description in (3) During communication at same potential (CSI mode)
		34	Modification of description in (4) During communication at same potential (CSI mode)
		36	Modification of table and Note 2 in (5) During communication at same potential (simplified I ² C mode)
		38, 39	Modification of table and Notes 1 to 9 in (6) Communication at different potential (1.8 V, 2.5 V, 3 V) (UART mode)
		40	Modification of Remarks 1 to 3 in (6) Communication at different potential (1.8 V, 2.5 V, 3 V) (UART mode)
		41	Modification of table in (7) Communication at different potential (2.5 V, 3 V) (CSI mode)
		42	Modification of Caution in (7) Communication at different potential (2.5 V, 3 V) (CSI mode)
43	Modification of table in (8) Communication at different potential (1.8 V, 2.5 V, 3 V) (CSI mode) (1/3)		
44	Modification of table and Notes 1 and 2 in (8) Communication at different potential (1.8 V, 2.5 V, 3 V) (CSI mode) (2/3)		
45	Modification of table, Note 1, and Caution 1 in (8) Communication at different potential (1.8 V, 2.5 V, 3 V) (CSI mode) (3/3)		
47	Modification of table in (9) Communication at different potential (1.8 V, 2.5 V, 3 V) (CSI mode)		
50	Modification of table, Note 1, and Caution 1 in (10) Communication at different potential (1.8 V, 2.5 V, 3 V) (simplified I ² C mode)		

Rev.	Date	Description	
		Page	Summary
2.00	Sep 06, 2013	52	Modification of Remark in 2.5.2 Serial interface IICA
		53	Addition of table to 2.6.1 A/D converter characteristics
		53	Modification of description in 2.6.1 (1)
		54	Modification of Notes 3 to 5 in 2.6.1 (1)
		54	Modification of description and Notes 2 to 4 in 2.6.1 (2)
		55	Modification of description and Notes 3 and 4 in 2.6.1 (3)
		56	Modification of description and Notes 3 and 4 in 2.6.1 (4)
		57	Modification of table in 2.6.2 Temperature sensor/internal reference voltage characteristics
		57	Modification of table and Note in 2.6.3 POR circuit characteristics
		58	Modification of table in 2.6.4 LVD circuit characteristics
		59	Modification of table of LVD detection voltage of interrupt & reset mode
		59	Modification of number and title to 2.6.5 Power supply voltage rising slope characteristics
		61	Modification of table, figure, and Remark in 2.10 Timing of Entry to Flash Memory Programming Modes
		62 to 103	Addition of products of industrial applications (G: T _A = -40 to +105°C)
		104 to 106	Addition of products of industrial applications (G: T _A = -40 to +105°C)
2.10	Mar 25, 2016	6	Modification of Figure 1-1 Part Number, Memory Size, and Package of RL78/G12
		7	Modification of Table 1-1 List of Ordering Part Numbers
		8	Addition of product name (RL78/G12) and description (Top View) in 1.4.1 20-pin products
		9	Addition of product name (RL78/G12) and description (Top View) in 1.4.2 24-pin products
		10	Addition of product name (RL78/G12) and description (Top View) in 1.4.3 30-pin products
		15	Modification of description in 1.7 Outline of Functions
		16	Modification of description, and addition of target products
		52	Modification of note 2 in 2.5.2 Serial interface IICA
		60	Modification of title and note, and addition of caution in 2.7 RAM Data Retention Characteristics
		60	Modification of conditions in 2.8 Flash Memory Programming Characteristics
		62	Modification of description, and addition of target products and remark
		94	Modification of note 2 in 3.5.2 Serial interface IICA
		102	Modification of title and note in 3.7 RAM Data Retention Characteristics
		102	Modification of conditions in 3.8 Flash Memory Programming Characteristics
		104 to 106	Addition of package name
2.20	Oct 31, 2018	4	Modification of Table 1-1 List of Ordering Part Numbers
		7	Modification of pin configuration diagram in 1.4.1 20-pin products
2.21	Jan 31, 2020	3	Addition of packaging specifications in Figure 1-1 Part Number, Memory Size, and Package of RL78/G12
		4, 5	Addition of part numbers and RENESAS codes in Table 1-1 List of Ordering Part Numbers
		105, 106, 108	Modification of the titles of the subchapters and deletion of product names in Chapter 4
		107	Addition of figure in 4.2 24-pin package
2.22	Apr 28, 2020	3	Addition of packaging specifications and package type in Figure 1-1 Part Number, Memory Size, and Package of RL78/G12
		4	Addition of packaging specifications in Table 1-1 List of Ordering Part Numbers
		9	Addition of packaging specifications in 1.4.1 20-pin products
		107	Addition of figure in 4.1 20-pin package

Rev.	Date	Description	
		Page	Summary
2.30	Jun 19, 2020	3	Modification of Figure 1-1 Part Number, Memory Size, and Package of RL78/G12
		4	Modification of Table 1-1 List of Ordering Part Numbers
2.31	Mar 20, 2023	All	The module name for CSI was changed to Simplified SPI (CSI)
		All	"wait" for IIC was modified to "clock stretch"
		1	Addition of Note 1 in 1 Features
		4	Modification of description in Table 1-1 List of Ordering Part Numbers
		108	Addition of package drawing in 4.4 24-pin Package
2.40	Mar 29, 2024	3	Modification of Figure 1-1. Part Number, Memory Size, and Package of RL78/G12
		4	Modification of Table 1-1. List of Ordering Part Numbers

All trademarks and registered trademarks are the property of their respective owners.

SuperFlash is a registered trademark of Silicon Storage Technology, Inc. in several countries including the United States and Japan.

Caution: This product uses SuperFlash® technology licensed from Silicon Storage Technology, Inc.
--

General Precautions in the Handling of Microprocessing Unit and Microcontroller Unit Products

The following usage notes are applicable to all Microprocessing unit and Microcontroller unit products from Renesas. For detailed usage notes on the products covered by this document, refer to the relevant sections of the document as well as any technical updates that have been issued for the products.

1. Precaution against Electrostatic Discharge (ESD)

A strong electrical field, when exposed to a CMOS device, can cause destruction of the gate oxide and ultimately degrade the device operation. Steps must be taken to stop the generation of static electricity as much as possible, and quickly dissipate it when it occurs. Environmental control must be adequate. When it is dry, a humidifier should be used. This is recommended to avoid using insulators that can easily build up static electricity. Semiconductor devices must be stored and transported in an anti-static container, static shielding bag or conductive material. All test and measurement tools including work benches and floors must be grounded. The operator must also be grounded using a wrist strap. Semiconductor devices must not be touched with bare hands. Similar precautions must be taken for printed circuit boards with mounted semiconductor devices.

2. Processing at power-on

The state of the product is undefined at the time when power is supplied. The states of internal circuits in the LSI are indeterminate and the states of register settings and pins are undefined at the time when power is supplied. In a finished product where the reset signal is applied to the external reset pin, the states of pins are not guaranteed from the time when power is supplied until the reset process is completed. In a similar way, the states of pins in a product that is reset by an on-chip power-on reset function are not guaranteed from the time when power is supplied until the power reaches the level at which resetting is specified.

3. Input of signal during power-off state

Do not input signals or an I/O pull-up power supply while the device is powered off. The current injection that results from input of such a signal or I/O pull-up power supply may cause malfunction and the abnormal current that passes in the device at this time may cause degradation of internal elements. Follow the guideline for input signal during power-off state as described in your product documentation.

4. Handling of unused pins

Handle unused pins in accordance with the directions given under handling of unused pins in the manual. The input pins of CMOS products are generally in the high-impedance state. In operation with an unused pin in the open-circuit state, extra electromagnetic noise is induced in the vicinity of the LSI, an associated shoot-through current flows internally, and malfunctions occur due to the false recognition of the pin state as an input signal become possible.

5. Clock signals

After applying a reset, only release the reset line after the operating clock signal becomes stable. When switching the clock signal during program execution, wait until the target clock signal is stabilized. When the clock signal is generated with an external resonator or from an external oscillator during a reset, ensure that the reset line is only released after full stabilization of the clock signal. Additionally, when switching to a clock signal produced with an external resonator or by an external oscillator while program execution is in progress, wait until the target clock signal is stable.

6. Voltage application waveform at input pin

Waveform distortion due to input noise or a reflected wave may cause malfunction. If the input of the CMOS device stays in the area between V_{IL} (Max.) and V_{IH} (Min.) due to noise, for example, the device may malfunction. Take care to prevent chattering noise from entering the device when the input level is fixed, and also in the transition period when the input level passes through the area between V_{IL} (Max.) and V_{IH} (Min.).

7. Prohibition of access to reserved addresses

Access to reserved addresses is prohibited. The reserved addresses are provided for possible future expansion of functions. Do not access these addresses as the correct operation of the LSI is not guaranteed.

8. Differences between products

Before changing from one product to another, for example to a product with a different part number, confirm that the change will not lead to problems. The characteristics of a microprocessing unit or microcontroller unit products in the same group but having a different part number might differ in terms of internal memory capacity, layout pattern, and other factors, which can affect the ranges of electrical characteristics, such as characteristic values, operating margins, immunity to noise, and amount of radiated noise. When changing to a product with a different part number, implement a system-evaluation test for the given product.

Notice

1. Descriptions of circuits, software and other related information in this document are provided only to illustrate the operation of semiconductor products and application examples. You are fully responsible for the incorporation or any other use of the circuits, software, and information in the design of your product or system. Renesas Electronics disclaims any and all liability for any losses and damages incurred by you or third parties arising from the use of these circuits, software, or information.
2. Renesas Electronics hereby expressly disclaims any warranties against and liability for infringement or any other claims involving patents, copyrights, or other intellectual property rights of third parties, by or arising from the use of Renesas Electronics products or technical information described in this document, including but not limited to, the product data, drawings, charts, programs, algorithms, and application examples.
3. No license, express, implied or otherwise, is granted hereby under any patents, copyrights or other intellectual property rights of Renesas Electronics or others.
4. You shall be responsible for determining what licenses are required from any third parties, and obtaining such licenses for the lawful import, export, manufacture, sales, utilization, distribution or other disposal of any products incorporating Renesas Electronics products, if required.
5. You shall not alter, modify, copy, or reverse engineer any Renesas Electronics product, whether in whole or in part. Renesas Electronics disclaims any and all liability for any losses or damages incurred by you or third parties arising from such alteration, modification, copying or reverse engineering.
6. Renesas Electronics products are classified according to the following two quality grades: "Standard" and "High Quality". The intended applications for each Renesas Electronics product depends on the product's quality grade, as indicated below.

"Standard": Computers; office equipment; communications equipment; test and measurement equipment; audio and visual equipment; home electronic appliances; machine tools; personal electronic equipment; industrial robots; etc.

"High Quality": Transportation equipment (automobiles, trains, ships, etc.); traffic control (traffic lights); large-scale communication equipment; key financial terminal systems; safety control equipment; etc.

Unless expressly designated as a high reliability product or a product for harsh environments in a Renesas Electronics data sheet or other Renesas Electronics document, Renesas Electronics products are not intended or authorized for use in products or systems that may pose a direct threat to human life or bodily injury (artificial life support devices or systems; surgical implantations; etc.), or may cause serious property damage (space system; undersea repeaters; nuclear power control systems; aircraft control systems; key plant systems; military equipment; etc.). Renesas Electronics disclaims any and all liability for any damages or losses incurred by you or any third parties arising from the use of any Renesas Electronics product that is inconsistent with any Renesas Electronics data sheet, user's manual or other Renesas Electronics document.

7. No semiconductor product is absolutely secure. Notwithstanding any security measures or features that may be implemented in Renesas Electronics hardware or software products, Renesas Electronics shall have absolutely no liability arising out of any vulnerability or security breach, including but not limited to any unauthorized access to or use of a Renesas Electronics product or a system that uses a Renesas Electronics product. RENESAS ELECTRONICS DOES NOT WARRANT OR GUARANTEE THAT RENESAS ELECTRONICS PRODUCTS, OR ANY SYSTEMS CREATED USING RENESAS ELECTRONICS PRODUCTS WILL BE INVULNERABLE OR FREE FROM CORRUPTION, ATTACK, VIRUSES, INTERFERENCE, HACKING, DATA LOSS OR THEFT, OR OTHER SECURITY INTRUSION ("Vulnerability Issues"). RENESAS ELECTRONICS DISCLAIMS ANY AND ALL RESPONSIBILITY OR LIABILITY ARISING FROM OR RELATED TO ANY VULNERABILITY ISSUES. FURTHERMORE, TO THE EXTENT PERMITTED BY APPLICABLE LAW, RENESAS ELECTRONICS DISCLAIMS ANY AND ALL WARRANTIES, EXPRESS OR IMPLIED, WITH RESPECT TO THIS DOCUMENT AND ANY RELATED OR ACCOMPANYING SOFTWARE OR HARDWARE, INCLUDING BUT NOT LIMITED TO THE IMPLIED WARRANTIES OF MERCHANTABILITY, OR FITNESS FOR A PARTICULAR PURPOSE.
8. When using Renesas Electronics products, refer to the latest product information (data sheets, user's manuals, application notes, "General Notes for Handling and Using Semiconductor Devices" in the reliability handbook, etc.), and ensure that usage conditions are within the ranges specified by Renesas Electronics with respect to maximum ratings, operating power supply voltage range, heat dissipation characteristics, installation, etc. Renesas Electronics disclaims any and all liability for any malfunctions, failure or accident arising out of the use of Renesas Electronics products outside of such specified ranges.
9. Although Renesas Electronics endeavors to improve the quality and reliability of Renesas Electronics products, semiconductor products have specific characteristics, such as the occurrence of failure at a certain rate and malfunctions under certain use conditions. Unless designated as a high reliability product or a product for harsh environments in a Renesas Electronics data sheet or other Renesas Electronics document, Renesas Electronics products are not subject to radiation resistance design. You are responsible for implementing safety measures to guard against the possibility of bodily injury, injury or damage caused by fire, and/or danger to the public in the event of a failure or malfunction of Renesas Electronics products, such as safety design for hardware and software, including but not limited to redundancy, fire control and malfunction prevention, appropriate treatment for aging degradation or any other appropriate measures. Because the evaluation of microcomputer software alone is very difficult and impractical, you are responsible for evaluating the safety of the final products or systems manufactured by you.
10. Please contact a Renesas Electronics sales office for details as to environmental matters such as the environmental compatibility of each Renesas Electronics product. You are responsible for carefully and sufficiently investigating applicable laws and regulations that regulate the inclusion or use of controlled substances, including without limitation, the EU RoHS Directive, and using Renesas Electronics products in compliance with all these applicable laws and regulations. Renesas Electronics disclaims any and all liability for damages or losses occurring as a result of your noncompliance with applicable laws and regulations.
11. Renesas Electronics products and technologies shall not be used for or incorporated into any products or systems whose manufacture, use, or sale is prohibited under any applicable domestic or foreign laws or regulations. You shall comply with any applicable export control laws and regulations promulgated and administered by the governments of any countries asserting jurisdiction over the parties or transactions.
12. It is the responsibility of the buyer or distributor of Renesas Electronics products, or any other party who distributes, disposes of, or otherwise sells or transfers the product to a third party, to notify such third party in advance of the contents and conditions set forth in this document.
13. This document shall not be reprinted, reproduced or duplicated in any form, in whole or in part, without prior written consent of Renesas Electronics.
14. Please contact a Renesas Electronics sales office if you have any questions regarding the information contained in this document or Renesas Electronics products.

(Note1) "Renesas Electronics" as used in this document means Renesas Electronics Corporation and also includes its directly or indirectly controlled subsidiaries.

(Note2) "Renesas Electronics product(s)" means any product developed or manufactured by or for Renesas Electronics.

(Rev.5.0-1 October 2020)

Corporate Headquarters

TOYOSU FORESIA, 3-2-24 Toyosu,
Koto-ku, Tokyo 135-0061, Japan
www.renesas.com

Trademarks



Renesas and the Renesas logo are trademarks of Renesas Electronics Corporation. All trademarks and registered trademarks are the property of their respective owners.

Contact Information







For further information on a product, technology, the most up-to-date version of a document, or your nearest sales office, please visit:
www.renesas.com/contact/

Looking for pricing, stock, or lifecycle information?

Click below to explore more details on WIN SOURCE:

-  [View R5F10268ASP#55 on WIN SOURCE](#)
-  [Renesas Electronics America Information](#)

Optimize Your Supply Chain with WIN SOURCE Solutions

-  Global Sourcing Solution
-  Obsolete Management
-  Cost Control Management
-  Shortage Management
-  Alternative Solution
-  Excess Inventory Management