



# SN75LBC786

## QUADRUPLE RS-423-B DRIVER/RECEIVER WITH LOOPBACK

SLLS184 – NOVEMBER 1994

- Four Independent Drivers and Receivers
- Loopback Mode Functionally Self Tests Drivers and Receivers Without Disconnection From Line
- Driver Slew Rate Controlled by a Single Resistor
- Internal Thermal-Overload Protection
- RS-423-B Inputs and Outputs Designed to Withstand  $\pm 25$  V
- ESD Protection Exceeds 2000 V Per MIL-STD-883C Method 3015
- LinBiCMOS™ Process Technology

DW PACKAGE  
(TOP VIEW)

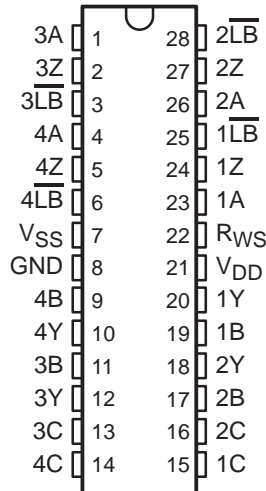

### description

The SN75LBC786 is a monolithic quadruple RS-423-B driver and receiver with integrated-loopback function. The operation of the SN75LBC786 is closely based on that of the SN75186. In normal operation, the device performs as four independent RS-423-B driver/receiver pairs designed to interface data-terminal equipment (DTE) with data circuit-terminating equipment (DCE). In loopback mode, the signal from each driver output is fed back via special circuitry into its associated receiver input, removing the need to locally disconnect cables and install a loopback connector. The receiver output signal is the same as the driver input signal.

The SN75LBC786 is characterized for operation over the temperature range of 0°C to 70°C.

FUNCTION TABLE

LOOPBACK LB	INPUTS			OUTPUTS	
	A	B	C	Z	Y
H	L	L	H	H	H
H	H	L	H	H	L
H	L	H	L	L	H
H	H	H	L	L	L
H	L	L	L	?	H
H	H	L	L	?	L
H	L	H	H	?	H
H	H	H	H	?	L
L	L	X	X	L	L
L	H	X	X	H	L

H = high level, L = low level, X = irrelevant, ? = indeterminate



Please be aware that an important notice concerning availability, standard warranty, and use in critical applications of Texas Instruments semiconductor products and disclaimers thereto appears at the end of this data sheet.

LinBiCMOS is a trademark of Texas Instruments Incorporated.

PRODUCTION DATA information is current as of publication date. Products conform to specifications per the terms of Texas Instruments standard warranty. Production processing does not necessarily include testing of all parameters.



POST OFFICE BOX 655303 • DALLAS, TEXAS 75265

Copyright © 1994, Texas Instruments Incorporated

# SN75LBC786 QUADRUPLE RS-423-B DRIVER/RECEIVER WITH LOOPBACK

SLLS184 – NOVEMBER 1994

## logic diagram (positive logic) (each transceiver)

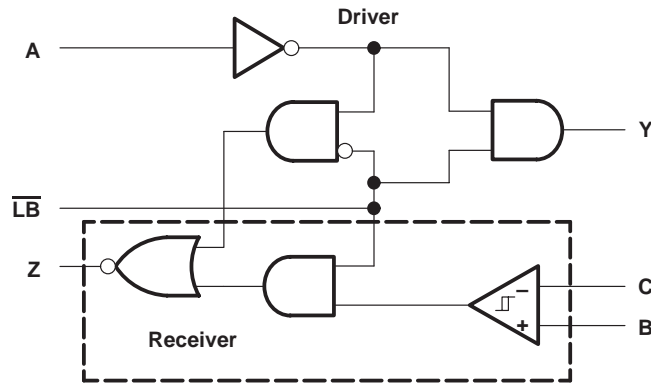

## absolute maximum ratings over operating free-air temperature range (unless otherwise noted)†

Positive supply voltage, $V_{DD}$ (see Note 1)	14 V
Negative supply voltage, $V_{SS}$	-14 V
Receiver input voltage range	-30 V to 30 V
Driver input voltage range	-0.5 V to 5.75 V
Loopback input voltage range	-0.5 V to 5.75 V
Driver output voltage range (supplies at 0 V)	-30 V to 30 V
Driver output voltage range (supplies at $\pm 12$ V)	-25 V to 25 V
Continuous power dissipation at (or below) $T_A = 70^\circ\text{C}$	800 mW
Operating free-air temperature range, $T_A$	$0^\circ\text{C}$ to $70^\circ\text{C}$
Storage temperature range, $T_{stg}$	$-65^\circ\text{C}$ to $150^\circ\text{C}$
Case temperature for 10 seconds	$260^\circ\text{C}$

† Stresses beyond those listed under "absolute maximum ratings" may cause permanent damage to the device. These are stress ratings only, and functional operation of the device at these or any other conditions beyond those indicated under "recommended operating conditions" is not implied. Exposure to absolute-maximum-rated conditions for extended periods may affect device reliability.

NOTE 1: All voltages are with respect to network ground terminal.

## recommended operating conditions

		MIN	NOM	MAX	UNIT
Supply voltage, $V_{DD}$		10.8	12	13.2	V
Supply voltage, $V_{SS}$		-10.8	-12	-13.2	V
High-level input voltage, $V_{IH}$	Driver and loopback	2			V
Low-level input voltage, $V_{IL}$	Driver and loopback			0.8	V
High-level output current, $I_{OH}$	Receiver			-4	mA
Low-level output current, $I_{OL}$	Receiver			4	mA
Slew rate control resistor, $R_{WS}$		20	82	820	k $\Omega$
Operating free-air temperature, $T_A$		0		70	$^\circ\text{C}$

# SN75LBC786

## QUADRUPLE RS-423-B DRIVER/RECEIVER WITH LOOPBACK

SLLS184 – NOVEMBER 1994

### DRIVER SECTION

**electrical characteristics over recommended ranges of supply voltage and operating free-air temperature (unless otherwise noted)**

PARAMETER		TEST CONDITIONS	MIN	TYP	MAX	UNIT
V <sub>OH</sub>	High-level output voltage	Open circuit or R <sub>I</sub> = 450 Ω	4	5.5	6	V
V <sub>OL</sub>	Low-level output voltage	Open circuit or R <sub>I</sub> = 450 Ω	-6	-5.5	-4	V
I <sub>IH</sub>	High-level input current	V <sub>I</sub> = 2.4 V – 5.5 V			100	μA
I <sub>IL</sub>	Low-level input current	V <sub>I</sub> = 0 V – 0.8 V	-100			μA
I <sub>IKG</sub>	Output leakage current	V <sub>DD</sub> = V <sub>SS</sub> = 0 V, V <sub>O</sub> = ±6 V	-100		100	μA
I <sub>OS(H)</sub>	High-level short-circuit output current	V <sub>I</sub> = high, V <sub>O</sub> = 0 V	15		45	mA
I <sub>OS(L)</sub>	Low-level short-circuit output current	V <sub>I</sub> = low, V <sub>O</sub> = 0 V	-45		-15	mA
I <sub>DD</sub>	Supply current (loopback off)	No load, $\overline{\text{LB}}$ at 2 V		10	12	mA
		R <sub>I</sub> = 450 Ω, $\overline{\text{LB}}$ at 2 V		60	70	
I <sub>DD(LB)</sub>	Supply current with loopback on	No load, $\overline{\text{LB}}$ at 0.8 V		13	16	mA
I <sub>SS</sub>	Supply current (loopback off)	No load, $\overline{\text{LB}}$ at 2 V		-10	-12	mA
		R <sub>I</sub> = 450 Ω, $\overline{\text{LB}}$ at 2 V		-60	-70	
I <sub>DD</sub>	Supply current with loopback on	No load, $\overline{\text{LB}}$ at 0.8 V		-13	-16	mA
<b>LOOPBACK MODE</b>						
Output voltage (input either high or low)		R <sub>I</sub> = > 450 Ω, V <sub>LB</sub> = low	-6	-5.5	-4	V

**switching characteristics over recommended ranges of supply voltage and operating free-air temperature (unless otherwise noted)**

PARAMETER		TEST CONDITIONS	MIN	TYP	MAX	UNIT	
t <sub>TLH</sub>	Transition time, low-to-high level output (see Figure 1)	R <sub>I</sub> = 450 Ω, V <sub>WS</sub> = 5 V, C <sub>L</sub> = 50 pF,	R <sub>WS</sub> = 0 kΩ		1.5	μs	
			R <sub>WS</sub> = 20 kΩ	1.5	2.1		2.7
			R <sub>WS</sub> = 82 kΩ	5	8		11
			R <sub>WS</sub> = 820 kΩ		80		
t <sub>THL</sub>	Transition time, high-to-low level output (see Figure 1)		R <sub>WS</sub> = 0 kΩ		1.5	μs	
			R <sub>WS</sub> = 20 kΩ	1.5	2.1		2.7
			R <sub>WS</sub> = 82 kΩ	5	8		11
SR	Output slew rate		R <sub>WS</sub> = 820 kΩ		80	V/μs	
		R <sub>WS</sub> = 20 kΩ		15			
t <sub>sk</sub>	Output skew,  t <sub>PHL</sub> - t <sub>PLH</sub>   (see Figure 4)	R <sub>WS</sub> = 82 kΩ		1	μs		



# SN75LBC786

## QUADRUPLE RS-423-B DRIVER/RECEIVER WITH LOOPBACK

SLLS184 – NOVEMBER 1994

### RECEIVER SECTION

**electrical characteristics over recommended ranges of supply voltage and operating free-air temperature (unless otherwise noted)**

PARAMETER		TEST CONDITIONS	MIN	TYP	MAX	UNIT
V <sub>IT</sub>	Receiver input threshold voltage (see Figure 5)	V <sub>IT</sub> = (V <sub>I+</sub> - V <sub>I-</sub> )	-200		200	mV
		V <sub>IT</sub> = (V <sub>I+</sub> - V <sub>I-</sub> ) with 500-Ω series resistor	-400		400	
I <sub>I</sub>	Input current	V <sub>I</sub> = 10 V		1.3	3.25	mA
		V <sub>I</sub> = -10 V	Other input to GND	-3.25	-1.3	
V <sub>hys</sub>	Hysteresis voltage		20	40	150	mV
V <sub>OH</sub>	High-level output voltage (see Note 2)	I <sub>O</sub> = -20 μA	3.5		5	V
		I <sub>O</sub> = -4 mA	2.4		5	
V <sub>OL</sub>	Low-level output voltage	I <sub>O</sub> = 20 μA to 4 mA			0.4	V
I <sub>OS</sub>	RX short circuit current				50	mA
V <sub>ID</sub>	Differential input voltage	Receiver inputs open circuit	1.6	2.1	2.6	V
V <sub>ofs</sub>	Fail safe output voltage	See Note 3	3.5			V

- NOTES: 2. Device has an internal RX supply regulator. Maximum RX logic output voltage under no load is thus defined by an internal voltage value. This is nominally set to 4.5 V with a tolerance of ±5%.  
 3. One input at ground, other input open circuit, I<sub>O</sub> = -20 μA, or both open circuit.

**switching characteristics over recommended ranges of supply voltage and operating free-air temperature (unless otherwise noted)**

PARAMETER		TEST CONDITIONS	MIN	NOM	MAX	UNIT
t <sub>PLH</sub>	Propagation delay time, low-to-high (see Figure 2)	C <sub>L</sub> = 50 pF		0.15	1	μs
t <sub>PHL</sub>	Propagation delay time, high-to-low (see Figure 2)					
t <sub>THL</sub>	Transition time, high-to-low (see Figure 3)			20	200	ns
t <sub>TLH</sub>	Transition time, low-to-high (see Figure 3)					



**PARAMETER MEASUREMENT INFORMATION**

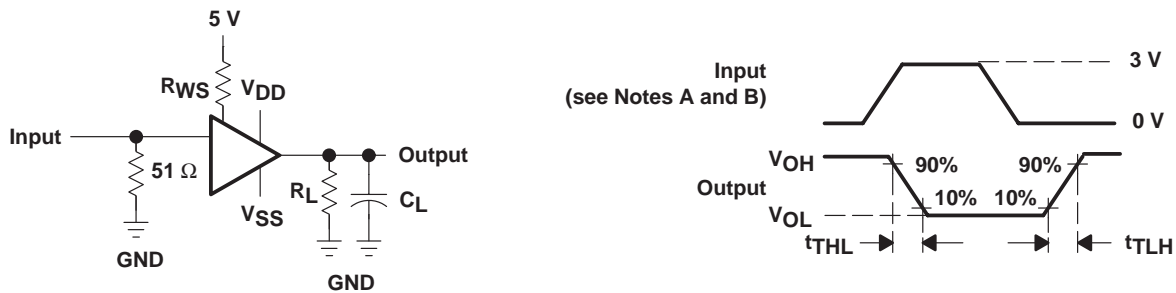

- NOTES: A.  $C_L$  includes probe and jig capacitance.  
 B. The input pulse is supplied by a generator having the following characteristics:  $t_r \leq 10$  nS,  $t_f < 10$  nS,  $Z_o = 50$  Ω, PRR  $\geq 5$  kHz, duty cycle = 50%,  $V_{max} = 3$  V,  $V_{min} = 0$  V.

**Figure 1. Driver Transition Times**

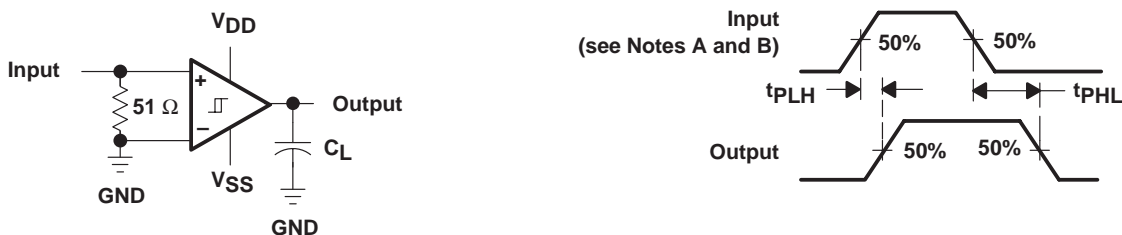

- NOTES: A.  $C_L$  includes probe and jig capacitance.  
 B. The input pulse is supplied by a generator having the following characteristics:  $t_r \leq 10$  nS,  $t_f < 10$  nS,  $Z_o = 50$  Ω, PRR  $\geq 5$  kHz, duty cycle = 50%,  $V_{max} = 0.5$  V,  $V_{min} = -0.5$  V.

**Figure 2. Receiver Propagation Delay Times**

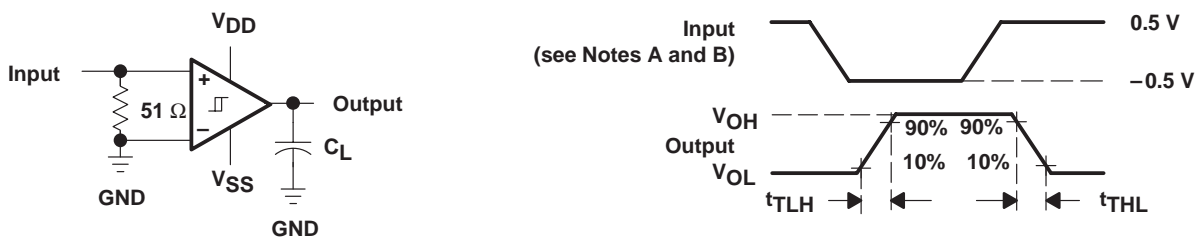

- NOTES: A.  $C_L$  includes probe and jig capacitance.  
 B. The input pulse is supplied by a generator having the following characteristics:  $t_r \leq 10$  nS,  $t_f < 10$  nS,  $Z_o = 50$  Ω, PRR  $\geq 5$  kHz, duty cycle = 50%,  $V_{max} = 0.5$  V,  $V_{min} = -0.5$  V.

**Figure 3. Receiver Transition Times**

# SN75LBC786 QUADRUPLE RS-423-B DRIVER/RECEIVER WITH LOOPBACK

SLLS184 – NOVEMBER 1994

## PARAMETER MEASUREMENT INFORMATION

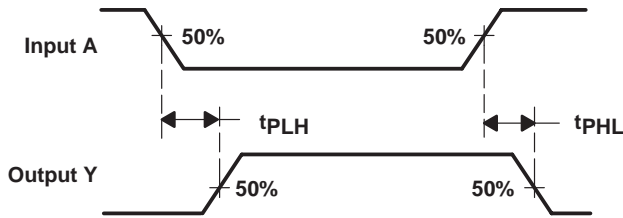

Figure 4. Skew Definition Times

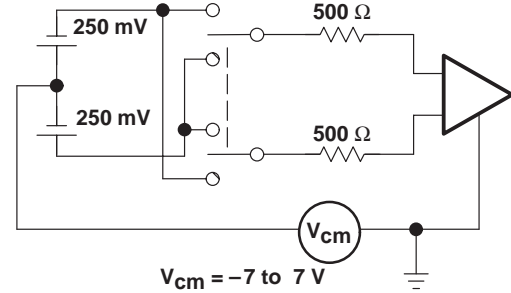

Figure 5. Input Balance Test

## PRINCIPLES OF OPERATION

In normal operation, the SN75LBC786 functions as four independent drivers and receivers. The loopback mode is disabled by maintaining a high logic level on the  $\overline{\text{LB}}$  input. The receivers consist of differential comparators with hysteresis and resistive attenuation on the inputs. The resistive attenuation improves the input common-mode range and also provides additional protection from ESD and over-voltage stress. The differential and common-mode input impedance are sufficiently high to meet RS-423-B. The balance of the receiver input voltage current characteristics and bias voltage is such that the receiver remains in the intended binary state when a differential voltage of 500 mV is applied to the inputs through 500 Ω across the entire common-mode range (see Figure 5).

The drivers meet all RS-423-B specifications. In normal operation, the drivers have built-in current limits and thermal overload protection. Slew-rate controlling circuitry is included into the design that is adjusted to suit the application by means of an external resistor. The slew-rate controlling circuitry also has a default mode. If R<sub>WS</sub> is shorted to 5 V externally, the transition time defaults to approximately 1.5 μs. The receiver is compatible to the RS-232 with the use of external input resistors to meet the RS-232 input-resistance specification of 3 kΩ to 7 kΩ.

Taking an individual  $\overline{\text{LB}}$  input low activates the loopback mode in the corresponding driver/receiver pair. This causes the output from that driver to be fed back to the input of its receiver through dedicated internal-loopback circuitry. Data from the receiver output can then be compared, by a communication system, with the data transmitted to the driver to determine if the functional operation of the driver and receiver together is correct.

In the loopback mode, external data at the input of the receiver is ignored and the driver does not transmit data onto the line. Extraneous data is prevented internally from being sent by the driver in the loopback mode by clamping its output to a level below the maximum interface voltage, -5 V, or the EIA-423-B marking state. Below this marking level, a reduced 1.5-V output amplitude is used at the driver output. This signal is detected by an on-chip loopback comparator and fed to the input stage of the receiver to complete the loop.

Line faults external to the SN75LBC786 are detected in addition to device failures. These line faults include short circuits to ground and to external supply voltages. The loopback mode should be entered only when the driver output is low, that is, the marking condition. It is recommended that loopback not be entered when the driver output is in a high state as this may cause a low-level, nondamaging oscillation at the driver output.

**PACKAGING INFORMATION**

Orderable Device	Status <sup>(1)</sup>	Package Type	Package Drawing	Pins	Package Qty	Eco Plan <sup>(2)</sup>	Lead/Ball Finish	MSL Peak Temp <sup>(3)</sup>
SN75LBC786DW	ACTIVE	SOIC	DW	28	20	Green (RoHS & no Sb/Br)	CU NIPDAU	Level-1-260C-UNLIM
SN75LBC786DWG4	ACTIVE	SOIC	DW	28	20	Green (RoHS & no Sb/Br)	CU NIPDAU	Level-1-260C-UNLIM

<sup>(1)</sup> The marketing status values are defined as follows:

**ACTIVE:** Product device recommended for new designs.

**LIFEBUY:** TI has announced that the device will be discontinued, and a lifetime-buy period is in effect.

**NRND:** Not recommended for new designs. Device is in production to support existing customers, but TI does not recommend using this part in a new design.

**PREVIEW:** Device has been announced but is not in production. Samples may or may not be available.

**OBsolete:** TI has discontinued the production of the device.

<sup>(2)</sup> Eco Plan - The planned eco-friendly classification: Pb-Free (RoHS), Pb-Free (RoHS Exempt), or Green (RoHS & no Sb/Br) - please check <http://www.ti.com/productcontent> for the latest availability information and additional product content details.

**TBD:** The Pb-Free/Green conversion plan has not been defined.

**Pb-Free (RoHS):** TI's terms "Lead-Free" or "Pb-Free" mean semiconductor products that are compatible with the current RoHS requirements for all 6 substances, including the requirement that lead not exceed 0.1% by weight in homogeneous materials. Where designed to be soldered at high temperatures, TI Pb-Free products are suitable for use in specified lead-free processes.

**Pb-Free (RoHS Exempt):** This component has a RoHS exemption for either 1) lead-based flip-chip solder bumps used between the die and package, or 2) lead-based die adhesive used between the die and leadframe. The component is otherwise considered Pb-Free (RoHS compatible) as defined above.

**Green (RoHS & no Sb/Br):** TI defines "Green" to mean Pb-Free (RoHS compatible), and free of Bromine (Br) and Antimony (Sb) based flame retardants (Br or Sb do not exceed 0.1% by weight in homogeneous material)

<sup>(3)</sup> MSL, Peak Temp. -- The Moisture Sensitivity Level rating according to the JEDEC industry standard classifications, and peak solder temperature.

**Important Information and Disclaimer:**The information provided on this page represents TI's knowledge and belief as of the date that it is provided. TI bases its knowledge and belief on information provided by third parties, and makes no representation or warranty as to the accuracy of such information. Efforts are underway to better integrate information from third parties. TI has taken and continues to take reasonable steps to provide representative and accurate information but may not have conducted destructive testing or chemical analysis on incoming materials and chemicals. TI and TI suppliers consider certain information to be proprietary, and thus CAS numbers and other limited information may not be available for release.

In no event shall TI's liability arising out of such information exceed the total purchase price of the TI part(s) at issue in this document sold by TI to Customer on an annual basis.

## IMPORTANT NOTICE

Texas Instruments Incorporated and its subsidiaries (TI) reserve the right to make corrections, modifications, enhancements, improvements, and other changes to its products and services at any time and to discontinue any product or service without notice. Customers should obtain the latest relevant information before placing orders and should verify that such information is current and complete. All products are sold subject to TI's terms and conditions of sale supplied at the time of order acknowledgment.

TI warrants performance of its hardware products to the specifications applicable at the time of sale in accordance with TI's standard warranty. Testing and other quality control techniques are used to the extent TI deems necessary to support this warranty. Except where mandated by government requirements, testing of all parameters of each product is not necessarily performed.

TI assumes no liability for applications assistance or customer product design. Customers are responsible for their products and applications using TI components. To minimize the risks associated with customer products and applications, customers should provide adequate design and operating safeguards.

TI does not warrant or represent that any license, either express or implied, is granted under any TI patent right, copyright, mask work right, or other TI intellectual property right relating to any combination, machine, or process in which TI products or services are used. Information published by TI regarding third-party products or services does not constitute a license from TI to use such products or services or a warranty or endorsement thereof. Use of such information may require a license from a third party under the patents or other intellectual property of the third party, or a license from TI under the patents or other intellectual property of TI.

Reproduction of information in TI data books or data sheets is permissible only if reproduction is without alteration and is accompanied by all associated warranties, conditions, limitations, and notices. Reproduction of this information with alteration is an unfair and deceptive business practice. TI is not responsible or liable for such altered documentation.

Resale of TI products or services with statements different from or beyond the parameters stated by TI for that product or service voids all express and any implied warranties for the associated TI product or service and is an unfair and deceptive business practice. TI is not responsible or liable for any such statements.

Following are URLs where you can obtain information on other Texas Instruments products and application solutions:

<b>Products</b>		<b>Applications</b>	
Amplifiers	<a href="http://amplifier.ti.com">amplifier.ti.com</a>	Audio	<a href="http://www.ti.com/audio">www.ti.com/audio</a>
Data Converters	<a href="http://dataconverter.ti.com">dataconverter.ti.com</a>	Automotive	<a href="http://www.ti.com/automotive">www.ti.com/automotive</a>
DSP	<a href="http://dsp.ti.com">dsp.ti.com</a>	Broadband	<a href="http://www.ti.com/broadband">www.ti.com/broadband</a>
Interface	<a href="http://interface.ti.com">interface.ti.com</a>	Digital Control	<a href="http://www.ti.com/digitalcontrol">www.ti.com/digitalcontrol</a>
Logic	<a href="http://logic.ti.com">logic.ti.com</a>	Military	<a href="http://www.ti.com/military">www.ti.com/military</a>
Power Mgmt	<a href="http://power.ti.com">power.ti.com</a>	Optical Networking	<a href="http://www.ti.com/opticalnetwork">www.ti.com/opticalnetwork</a>
Microcontrollers	<a href="http://microcontroller.ti.com">microcontroller.ti.com</a>	Security	<a href="http://www.ti.com/security">www.ti.com/security</a>
Low Power Wireless	<a href="http://www.ti.com/lpw">www.ti.com/lpw</a>	Telephony	<a href="http://www.ti.com/telephony">www.ti.com/telephony</a>
		Video & Imaging	<a href="http://www.ti.com/video">www.ti.com/video</a>
		Wireless	<a href="http://www.ti.com/wireless">www.ti.com/wireless</a>

Mailing Address: Texas Instruments  
Post Office Box 655303 Dallas, Texas 75265

## Looking for pricing, stock, or lifecycle information?

Click below to explore more details on WIN SOURCE:

 [View SN75LBC786DWG4 on WIN SOURCE](#)

 [Texas Instruments](#) Information

## Optimize Your Supply Chain with WIN SOURCE Solutions

-  Global Sourcing Solution
-  Obsolete Management
-  Cost Control Management
-  Shortage Management
-  Alternative Solution
-  Excess Inventory Management