



THE DATASHEET OF AUIRS2092S



Features

- Integrated analog input Class D audio amplifier driver in a small 16 pin package
- Floating inputs enable easy half bridge implementation
- Programmable bidirectional over-current protection with self-reset function
- Programmable preset deadtime for improved THD performances
- Start and stop click noise reduction
- High noise immunity
- ± 100 V ratings deliver up to 500 W in output power
- Operates up to 800 kHz
- Leadfree, RoHS compliant
- Automotive Qualified^T

Product Summary

V_{OFFSET} (max)	± 100 V	
Gate driver	Io+ (typical)	1.0 A
	Io- (typical)	1.2 A
Selectable Deadtime	25/40/65/105 ns	
OC protection delay (max)	500 ns	
DC offset	<20 mV	
PWM frequency	~800 kHz	
Error amplifier open loop gain	>60 dB	
THD+N* (1kHz, 50W, 4 Ω)	0.01 %	
Residual Noise* (AES-17 Filter)	200 μ Vrms	

* measured with recommended circuit

Typical Applications

- Automotive mini component stereo systems
- Automotive powered speaker systems
- Automotive audio power amplifiers

Package Options



Typical Connection Diagram

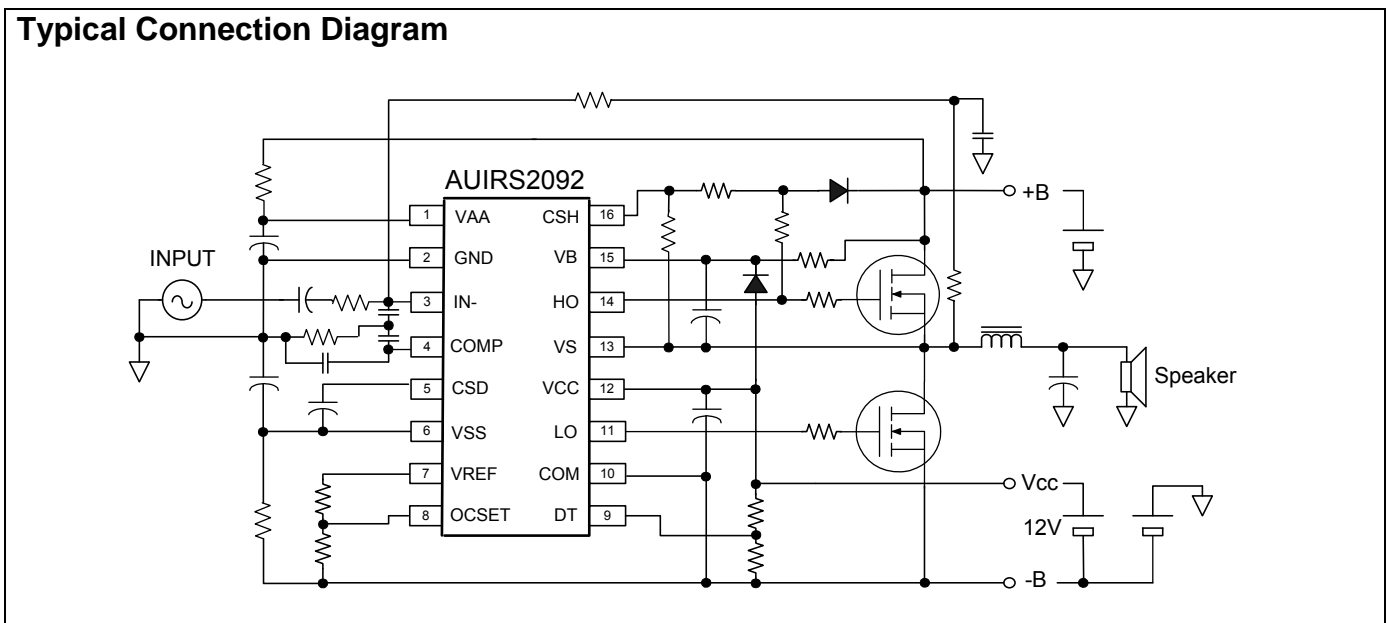

Table of Contents	Page
Description	3
Simplified Block Diagram	4
Typical Application Diagram	4
Qualification Information	5
Absolute Maximum Ratings	6
Recommended Operating Conditions	7
Electrical Characteristics	8-10
Waveform Definitions	11
Functional Block Diagram	12
Input/Output Pin Equivalent Circuit Diagram	13
Lead Definitions	14
Lead Assignments	14
Parameter Temperature Trends	15-19
Package Details	19
Tape and Reel Details	20
Part Marking Information	21
Ordering Information	21

Description

The AUIRS2092 is a high voltage, high performance Class D audio amplifier driver with PWM modulator and protection. In conjunction with two external MOSFET and a few external components, a complete Class D audio amplifier with protection can be realized.

International Rectifier's proprietary noise isolation technology allows high current gate drive stage and high speed low noise error amplifier reside on a single small silicon die.

Open elements of PWM modulator section allow flexible PWM topology implementation.

Qualification Information[†]

Qualification Level		Automotive (per AEC-Q100 ^{††})	
		Comments: This family of ICs has passed an Automotive qualification. IR's Industrial and Consumer qualification level is granted by extension of the higher Automotive level.	
Moisture Sensitivity Level		SOIC16N	MSL3 ^{†††} 260°C (per IPC/JEDEC J-STD-020)
ESD	Machine Model	Class M2 (+/-150V) (per AEC-Q100-003)	
	Human Body Model	Class H1B (+/-750V) (per AEC-Q100-002)	
	Charged Device Model	Class C3A (+/-750V) (per AEC-Q100-011)	
IC Latch-Up Test		Class II, Level B ^{††††} (per AEC-Q100-004)	
RoHS Compliant		Yes	

† Qualification standards can be found at International Rectifier's web site <http://www.irf.com/>

†† Exceptions to AEC-Q100 requirements are noted in the qualification report.

††† Higher MSL ratings may be available for the specific package types listed here. Please contact your International Rectifier sales representative for further information.

†††† CSD pin stressed to +/-20mA, CSH pin stressed to +/-40mA, DT and OCSET pins stressed to +/-20mA

Absolute Maximum Ratings

Absolute Maximum Ratings indicate sustained limits beyond which damage to the device may occur. All voltage parameters are absolute voltages referenced to COM lead. Stresses beyond those listed under "Absolute Maximum Ratings" may cause permanent damage to the device. These are stress ratings only; and functional operation of the device at these or any other condition beyond those indicated in the "Recommended Operating Conditions" is not implied. Exposure to absolute-maximum-rated conditions for extended periods may affect device reliability. The thermal resistance and power dissipation ratings are measured under board mounted and still air conditions. Ambient temperature (T_A) is 25°C, unless otherwise specified.

Symbol	Definition	Min	Max	Units
V_B	High side floating supply voltage	-0.3	220	V
V_S	High side floating supply voltage (Note2)	$V_B - 20$	$V_B + 0.3$	
V_{HO}	High side floating output voltage	$V_S - 0.3$	$V_B + 0.3$	
V_{CSH}	CSH pin input voltage	$V_S - 0.3$	$V_B + 0.3$	
V_{CC}	Low side fixed supply voltage (Note2)	-0.3	20	
V_{LO}	Low side output voltage	-0.3	$V_{CC} + 0.3$	
V_{AA}	Floating input positive supply voltage (Note2)	(See I_{AAZ})	210	
V_{SS}	Floating input negative supply voltage (Note2)	-1 (See I_{SSZ})	GND + 0.3	
V_{GND}	Floating input supply ground voltage	$V_{SS} - 0.3$ (See I_{SSZ})	$V_{AA} + 0.3$ (See I_{AAZ})	
I_{IN-}	Inverting input current (Note1)	---	±3	mA
V_{CSD}	SD pin input voltage	$V_{SS} - 0.3$	$V_{AA} + 0.3$	V
V_{COMP}	COMP pin input voltage	$V_{SS} - 0.3$	$V_{AA} + 0.3$	
V_{DT}	DT pin input voltage	-0.3	$V_{CC} + 0.3$	
V_{OCSET}	OCSET pin input voltage	-0.3	$V_{CC} + 0.3$	
I_{AAZ}	Floating input positive supply zener clamp current (Note2)	---	20	mA
I_{SSZ}	Floating input negative supply zener clamp current (Note2)	---	20	
I_{CCZ}	Low side supply zener clamp current (Note3)	---	10	
I_{BSZ}	Floating supply zener clamp current (Note3)	---	10	
I_{OREF}	Reference output current	---	5	
dV_S/dt	Allowable V_S voltage slew rate	---	50	V/ns
dV_{SS}/dt	Allowable V_{SS} voltage slew rate (Note3)	---	50	V/ms
P_d	Maximum power dissipation @ $T_A \leq +25^\circ\text{C}$	---	1.0	W
R_{thJA}	Thermal resistance, Junction to ambient	---	115	°C/W
T_J	Junction Temperature	---	150	°C
T_S	Storage Temperature	-55	150	°C
T_L	Lead temperature (soldering, 10 seconds)	---	300	°C

Note1: IN- contains clamping diode to GND.

Note2: $V_{DD} - IN+$, GND - V_{SS} , $V_{CC} - COM$ and $V_B - V_S$ contain internal shunt zener diodes. Please note that the voltage ratings of these can be limited by the clamping current.

Note3: For the rising and falling edges of step signal of 10 V. $V_{SS} = 15\text{ V to } 200\text{ V}$.

Recommended Operating Conditions

For proper operation, the device should be used within the recommended conditions below. The V_S and COM offset ratings are tested with supplies biased at $V_{AA}-V_{SS}=10\text{ V}$, $V_{CC}=12\text{ V}$ and $V_B-V_S=12\text{ V}$. All voltage parameters are absolute voltages referenced to COM; all currents are defined positive into any lead.

Symbol	Definition	Min.	Max.	Units	
V_B	High side floating supply absolute voltage	$V_S + 10$	$V_S + 18$	V	
V_S	High side floating supply offset voltage	(Note 1)	200		
I_{AAZ}	Floating input positive supply zener clamp current	1	11	mA	
I_{SSZ}	Floating input negative supply zener clamp current	1	11		
V_{SS}	Floating input supply absolute voltage	0	200	V	
V_{HO}	High side floating output voltage	V_S	V_B		
V_{CC}	Low side fixed supply voltage	10	18		
V_{LO}	Low side output voltage	0	V_{CC}		
V_{GND}	GND pin input voltage	V_{SS} (Note 3)	V_{AA} (Note 3)		
V_{IN-}	Inverting input voltage	$V_{GND} - 0.5$	$V_{GND} + 0.5$		
V_{CSD}	CSD pin input voltage	V_{SS}	V_{AA}		
V_{COMP}	COMP pin input voltage	V_{SS}	V_{AA}		
C_{COMP}	COMP pin phase compensation capacitor to GND	1	-		nF
V_{DT}	DT pin input voltage	0	V_{CC}		V
I_{OREF}	Reference output current to COM (Note 2)	0.3	0.8	mA	
V_{OCSET}	OCSET pin input voltage	0.5	5		
V_{CSH}	CSH pin input voltage	V_S	V_B	V	
dV_{SS}/dt	Allowable V_{SS} voltage slew rate upon power-up (Note4)	-	50	V/ms	
I_{PW}	Input pulse width	10 (Note 5)	-	ns	
f_{SW}	Switching Frequency	-	800	kHz	
T_A	Ambient Temperature	-40	125	°C	

Note 1: Logic operational for V_S equal to -5 V to $+200\text{ V}$. Logic state held for V_S equal to -5 V to $-V_{BS}$.

Note 2: Nominal voltage for V_{REF} is 5.1 V . I_{OREF} of $0.3 - 0.8\text{ mA}$ dictates total external resistor value on V_{REF} to be $6.3\text{ k}\Omega$ to $16.7\text{ k}\Omega$.

Note 3: GND input voltage is limited by I_{AAZ} and I_{SSZ} .

Note 4: V_{SS} ramps up from 0 V to 200 V .

Note 5: Output logic status may not respond correctly if input pulse width is smaller than the minimum pulse width.

Electrical Characteristics

Unless otherwise noted, these specifications apply for an operating junction temperature range of $-40^{\circ}\text{C} \leq T_j \leq 125^{\circ}\text{C}$ with bias conditions of $V_{CC}, V_{BS} = 12\text{ V}$, $V_{SS} = V_S = \text{COM} = 0\text{ V}$, $V_{AA} = 10\text{ V}$, $C_L = 1\text{ nF}$.

Symbol	Definition	Min	Typ	Max	Units	Test Conditions
Low Side Supply						
UV _{CC+}	V _{CC} supply UVLO positive threshold	8.4	8.9	9.8	V	
UV _{CC-}	V _{CC} supply UVLO negative threshold	8.2	8.7	9.4		
UV _{CC} HYS	UV _{CC} hysteresis	-	0.2	-		
I _{QCC}	Low side quiescent current	-	-	3	mA	V _{DT} =V _{CC}
V _{CLAMPL}	Low side zener diode clamp voltage	19.6	20.4	21.6	V	I _{CC} =5 mA
High Side Floating Supply						
UV _{BS+}	High side well UVLO positive threshold	8.0	8.5	9.7	V	
UV _{BS-}	High side well UVLO negative threshold	7.8	8.3	9.0		
UV _{BS} HYS	UV _{BS} hysteresis	-	0.2	-		
I _{QBS}	High side quiescent current	-	-	1	mA	
I _{LKH}	High to Low side leakage current	-	-	50	μA	V _B =V _S =200 V
V _{CLAMPH}	High side zener diode clamp voltage	19.6	20.4	21.6	V	I _{BS} =5 mA
Floating Input Supply						
UV _{AA+}	VA+, VA- floating supply UVLO positive threshold from V _{SS}	8.2	8.7	9.7	V	V _{SS} =0 V, GND pin floating
UV _{AA-}	VA+, VA- floating supply UVLO negative threshold from V _{SS}	7.7	8.2	9.0		V _{SS} =0 V, GND pin floating
UV _{AA} HYS	UV _{AA} hysteresis	-	0.5	-		V _{SS} =0 V, GND pin floating
I _{QAA0}	Floating Input positive quiescent supply current	-	0.5	2	mA	V _{AA} =10 V, V _{SS} =0 V, V _{CSD} =V _{SS}
I _{QAA1}	Floating Input positive quiescent supply current	-	6.5	11		V _{AA} =10 V, V _{SS} =0 V, V _{CSD} =V _{AA} , T _j = -40C
		-	8	11		V _{AA} =10 V, V _{SS} =0 V, V _{CSD} =V _{AA} , T _j = 25C
		-	9.5	12.5		V _{AA} =10 V, V _{SS} =0 V, V _{CSD} =V _{AA} , T _j = 125C
I _{QAA2}	Floating Input positive quiescent supply current	-	6.5	11		V _{AA} =10 V, V _{SS} =0 V, V _{CSD} =GND, T _j = -40C
		-	8	11		V _{AA} =10 V, V _{SS} =0 V, V _{CSD} =GND, T _j = 25C
		-	9.5	12.5	V _{AA} =10 V, V _{SS} =0 V, V _{CSD} =GND, T _j = 125C	
I _{LKM}	Floating input side to Low side leakage current	-	-	50	μA	V _{AA} =V _{SS} =V _{GND} =100 V
V _{CLAMPM+}	V _{AA} floating supply zener diode clamp voltage, positive, with respect to GND	6.0	7.0	8.0	V	I _{AA} =5 mA, I _{SS} =5 mA, V _{GND} =0 V, V _{CSD} =V _{SS}
V _{CLAMPM-}	V _{SS} floating supply zener diode clamp voltage, negative, with respect to GND	-8.0	-7.0	-6.0		I _{AA} =5 mA, I _{SS} =5 mA, V _{GND} =0 V, V _{CSD} =V _{SS}
Audio Input (V_{GND}=0, V_{AA}=5V, V_{SS}=-5V)						
V _{OS}	Input offset voltage	-20	0	20	mV	T _j = -40C
		-15	0	15	mV	T _j = 25C
		-18	0	18	mV	T _j = 125C
I _{BIN}	Input bias current	-	-	40	nA	

BW	Small signal bandwidth	-	9	-	MHz	$C_{COMP}=2\text{ nF}$, $R_f=3.3\text{ k}\Omega$
V_{COMP}	OTA Output voltage	VAA-1	-	VSS+1	V	
g_m	OTA transconductance	-	100	-	mS	$V_{IN}=10\text{ mV}$
G_v	OTA gain	60	-	-	dB	
V_{Nrms}	OTA input noise voltage	-	250	-	mVrms	BW=20 kHz, Resolution BW=22 Hz Fig.5
SR	Slew rate	-	± 5	-	V/us	$C_{COMP}=1\text{ nF}$
CMRR	Common-mode rejection ratio	-	60	-	dB	
PSRR	Supply voltage rejection ratio	-	65	-		
PWM comparator						
V_{th_PWM}	PWM comparator threshold in COMP	-	$(V_{AA}-V_{SS})/2$	-	V	
f_{OTA}	COMP pin star-up local oscillation frequency	0.7	1.0	1.3	MHz	$V_{CSD} = GND$
Protection						
V_{REF}	Reference output voltage	4.8	5.1	5.5	V	$I_{OREF} = 0.5\text{ mA}$ OCSET=1.2 V, Fig.6 $V_s=200\text{ V}$,
V_{th_OCL}	Low side OC threshold in Vs	1.1	1.2	1.3		
V_{th_OCH}	High side OC threshold in V_{CSH}	1.1+ Vs	1.2+ Vs	1.3+ Vs		
V_{th1}	CSD pin shutdown release threshold	$0.62 \times V_{DD}$	$0.70 \times V_{DD}$	$0.78 \times V_{DD}$		
V_{th2}	CSD pin self reset threshold	$0.26 \times V_{DD}$	$0.30 \times V_{DD}$	$0.34 \times V_{DD}$		
I_{CSD+}	CSD pin discharge current	60	100	150	μA	$V_{CSD} = V_{SS} + 5\text{ V}$ $V_{CSD} = V_{SS} + 5\text{ V}$
I_{CSD-}	CSD pin charge current	60	100	150		
t_{SD}	Shutdown propagation delay from $V_{CSD} > V_{SS} + V_{th_OCH}$ to Shutdown	-	-	250	ns	
t_{OCH}	Propagation delay time from $V_{CSH} > V_{th_OCH}$ to Shutdown	-	-	650		Fig.3
t_{OCL}	Propagation delay time from $V_s > V_{th_OCL}$ to Shutdown	-	-	650		Fig.4
Gate Driver						
I_{o+}	Output high short circuit current (Source)	-	1.0	-	A	$V_o=0\text{ V}$, $PW < 10\ \mu s$
I_{o-}	Output low short circuit current (Sink)	-	1.2	-	A	$V_o=12\text{ V}$, $PW < 10\ \mu s$
V_{OL}	Low level out put voltage LO – COM, HO - VS	-	-	0.1	V	$I_o=2\text{ mA}$
V_{OH}	High level out put voltage VCC – LO, VB - HO	-	-	2.3		
t_{on}	High and low side turn-on propagation delay	-	360	-	ns	$V_{DT} = V_{CC}$
t_{off}	High and low side turn-off propagation delay	-	335	-		$V_{DT} = V_{CC}$
t_r	Turn-on rise time	-	20	50		
t_f	Turn-off fall time	-	15	35		
DT1	Deadtime: LO turn-off to HO turn-on (DT_{LO-HO}) & HO turn-off to LO turn-on (DT_{HO-LO})	5	20	35		$V_{DT} > V_{DT1}$, $T_j = -40C$
		15	25	35		$V_{DT} > V_{DT1}$, $T_j = 25C$
		20	35	50		$V_{DT} > V_{DT1}$, $T_j = 125C$
DT2	Deadtime: LO turn-off to HO turn-on (DT_{LO-HO}) & HO turn-off to LO turn-on (DT_{HO-LO})	20	35	55	$V_{DT1} > V_{DT} > V_{DT2}$, $T_j = -40C$	
		25	40	55	$V_{DT1} > V_{DT} > V_{DT2}$, $T_j = 25C$	
		30	50	70	$V_{DT1} > V_{DT} > V_{DT2}$, $T_j = 125C$	
DT3	Deadtime: LO turn-off to HO turn-on (DT_{LO-HO}) & HO turn-off to LO turn-on (DT_{HO-LO})	40	65	95	$V_{DT2} > V_{DT} > V_{DT3}$, $T_j = -40C$	
		50	65	85	$V_{DT2} > V_{DT} > V_{DT3}$, $T_j = 25C$	

		50	80	105		$V_{DT2} > V_{DT} > V_{DT3}$, $T_j = 125C$
DT4	Deadtime: LO turn-off to HO turn-on (DT_{LO-HO}) & HO turn-off to LO turn-on (DT_{HO-LO}) $V_{DT} = V_{DT4}$	65	110	150	V	$V_{DT3} > V_{DT} > V_{DT4}$, $T_j = -40C$
		85	105	135		$V_{DT3} > V_{DT} > V_{DT4}$, $T_j = 25C$
		80	115	155		$V_{DT3} > V_{DT} > V_{DT4}$, $T_j = 125C$
V_{DT1}	DT mode select threshold 2	$0.51xV_{cc}$	$0.57xV_{cc}$	$0.63xV_{cc}$		
V_{DT2}	DT mode select threshold 3	$0.32xV_{cc}$	$0.36xV_{cc}$	$0.40xV_{cc}$		
V_{DT3}	DT mode select threshold 4	$0.21xV_{cc}$	$0.23xV_{cc}$	$0.25xV_{cc}$		

Waveform Definitions

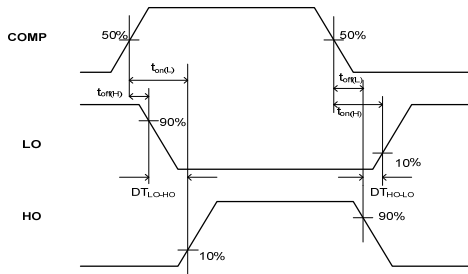

Figure 1: Switching Time Waveform Definitions

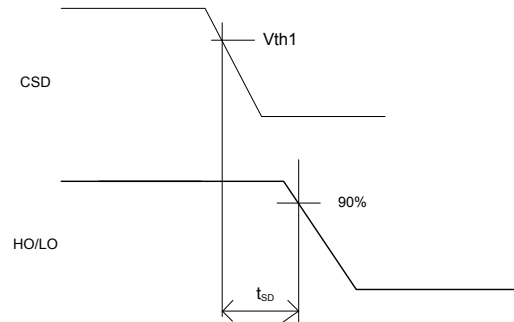

Figure 2: CSD to Shutdown Waveform Definitions

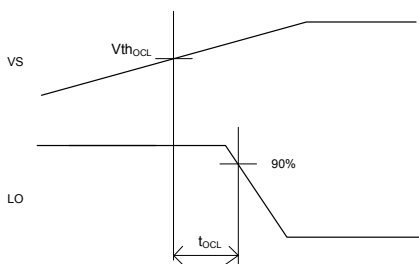

Figure 3: $V_S > V_{thOCL}$ to Shutdown Waveform

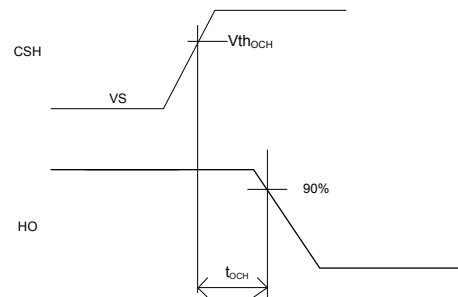

Figure 4: $V_{CSH} > V_{thOCH}$ to Shutdown Waveform

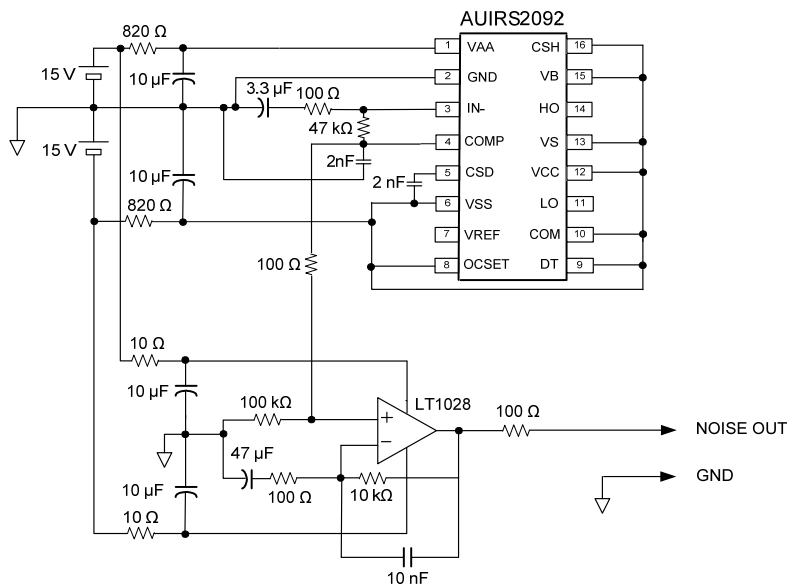
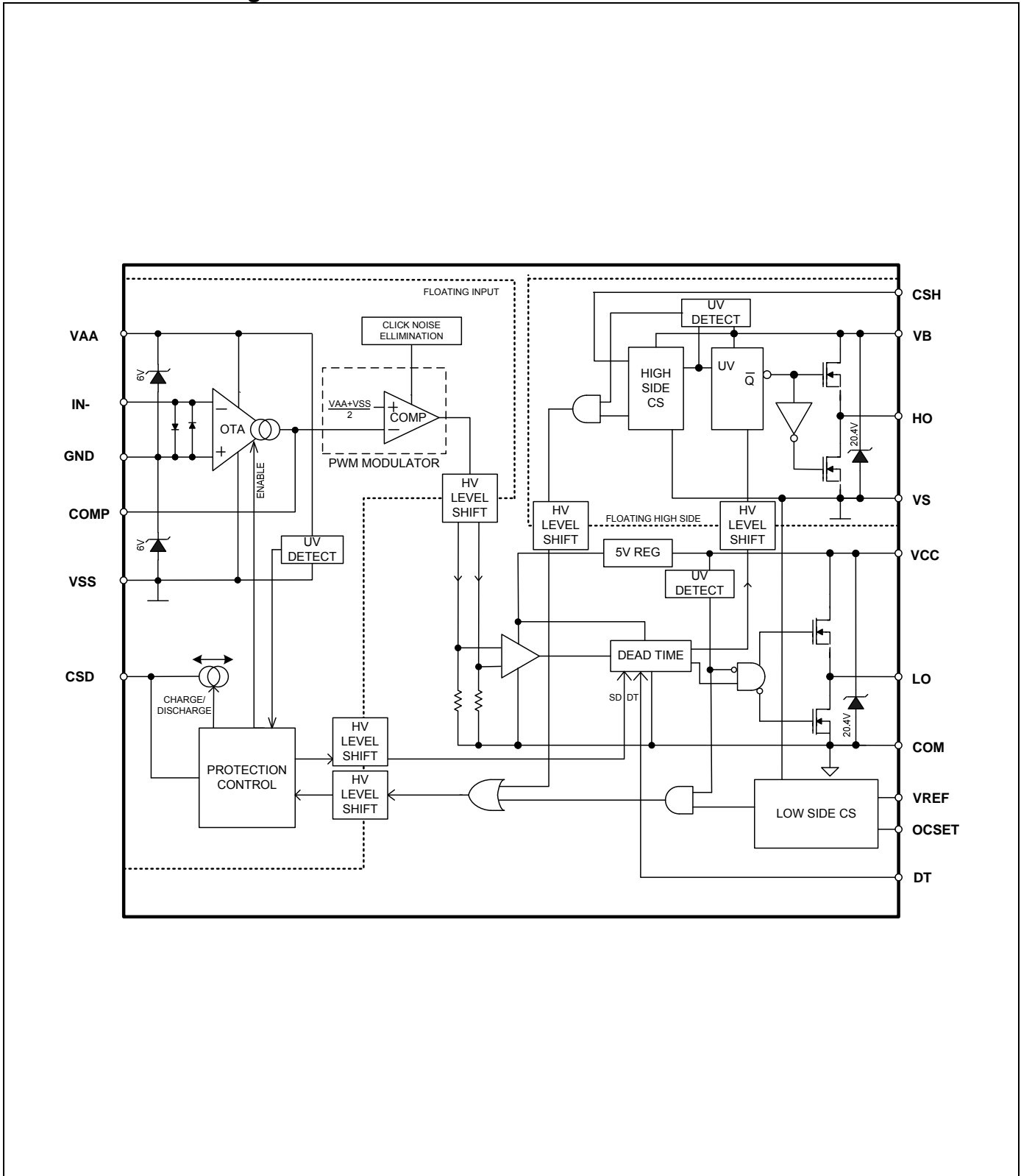
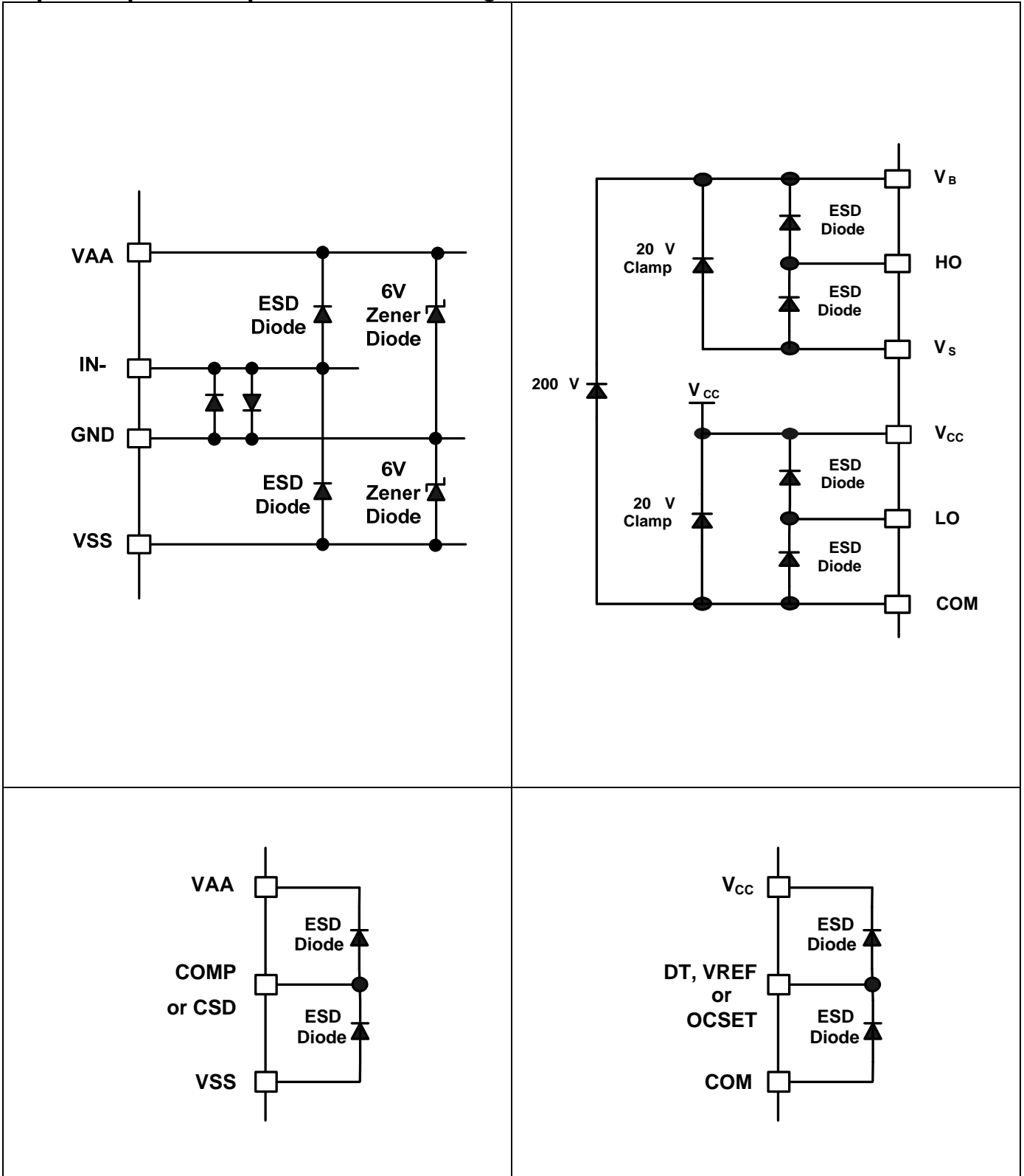

Figure 5: OTA input noise voltage measurement circuit

Functional Block Diagram: AUIRS2092



Input/Output Pin Equivalent Circuit Diagrams: AUIRS2092



Lead Definitions: AUIRS2092

Pin #	Symbol	Description
1	VAA	Floating input positive supply
2	GND	Floating input supply return
3	IN-	Analog inverting input
4	COMP	Phase compensation input, comparator input
5	CSD	Shutdown timing capacitor
6	VSS	Floating input negative supply
7	VREF	5V reference voltage to program OCSET pin
8	OCSET	Low side over current threshold setting
9	DT	Deadtime program input
10	COM	Low side supply return
11	LO	Low side output
12	VCC	Low side supply
13	VS	High side floating supply return
14	HO	High side output
15	VB	High side floating supply
16	CSH	High side over current sensing input

Lead Assignments



Parameter Temperature Trends

Figures illustrated in this chapter provide information on the experimental performance of the AUIRS2092S HVIC. The line plotted in each figure is generated from actual lab data. A large number of individual samples were tested at three temperatures (-40 °C, 25 °C, and 125 °C) in order to generate the experimental curve. The line consists of three data points (one data point at each of the tested temperatures) that have been connected together to illustrate the understood trend. The individual data points on the Typ. curve were determined by calculating the averaged experimental value of the parameter (for a given temperature).

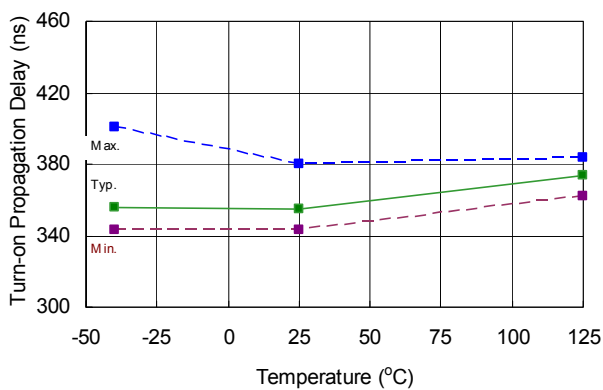

Figure 6: t_{ON} vs. temperature

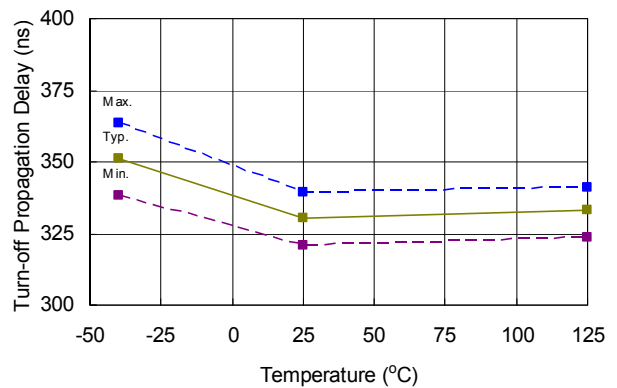

Figure 7: t_{OFF} vs. temperature

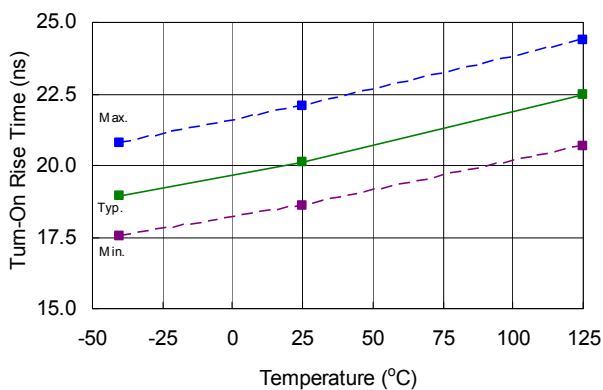

Figure 8: T_R vs. temperature

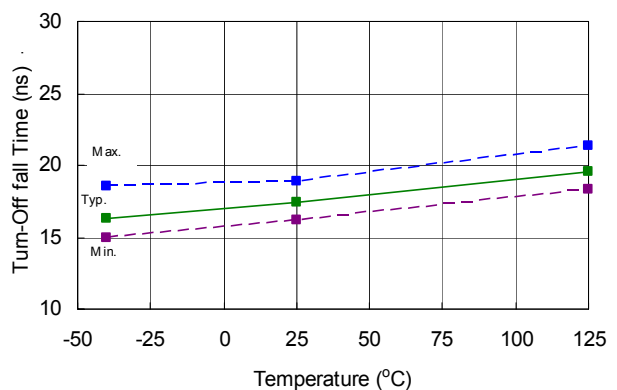

Figure 9: T_F vs. temperature

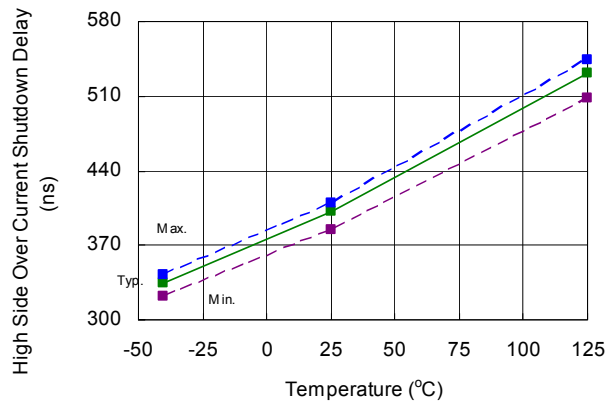

Figure 10: T_{OCH} vs. temperature

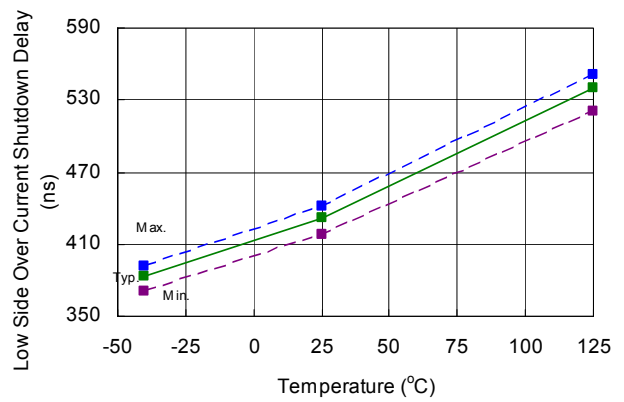

Figure 11: T_{OCL} vs. temperature

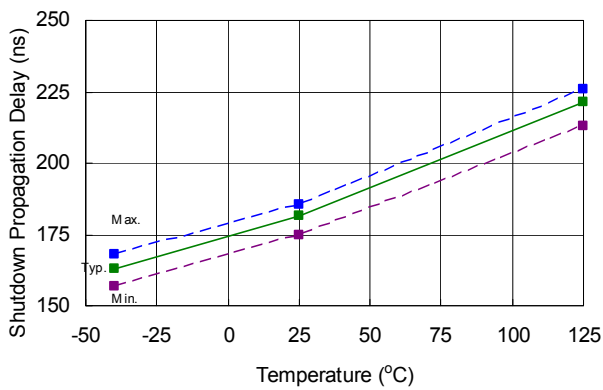

Figure 12: T_{SD} vs. temperature

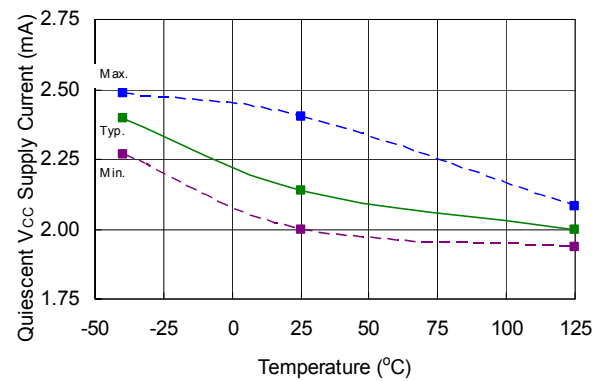

Figure 13: I_{QCC} vs. temperature

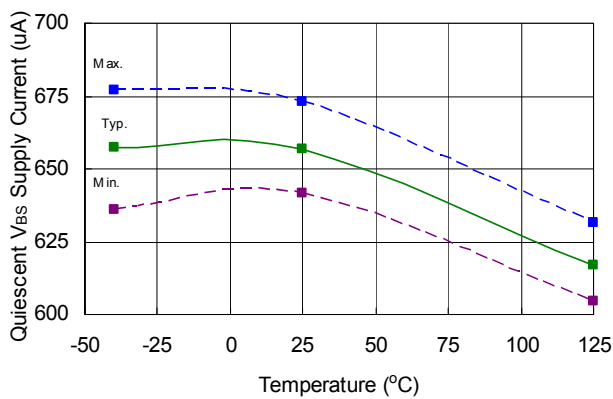

Figure 14: I_{QBS} vs. temperature

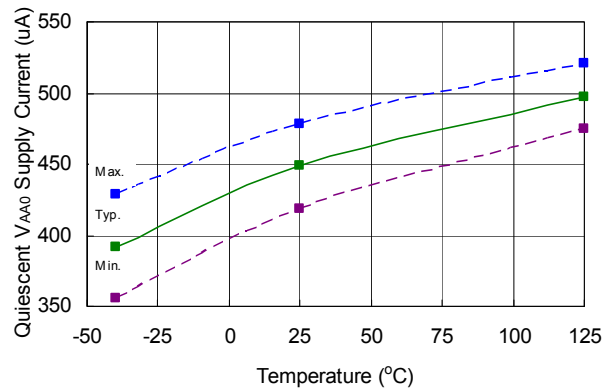

Figure 15: I_{QAA0} vs. temperature

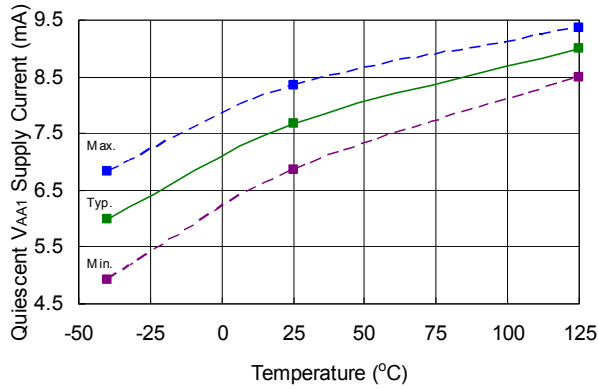

Figure 16: I_{QAA1} vs. temperature

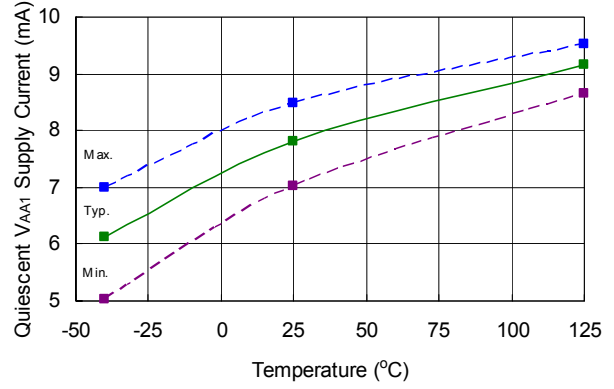

Figure 17: I_{QAA2} vs. temperature

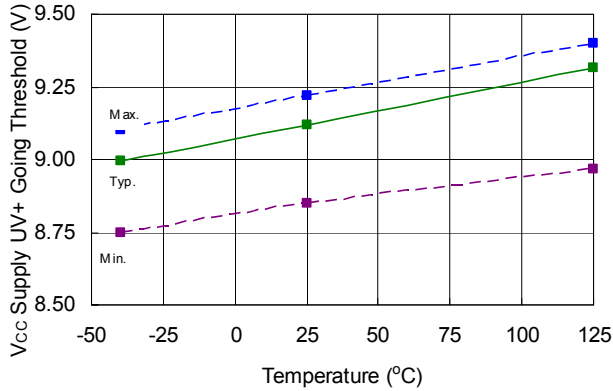

Figure 18: V_{CCUV+} vs. temperature

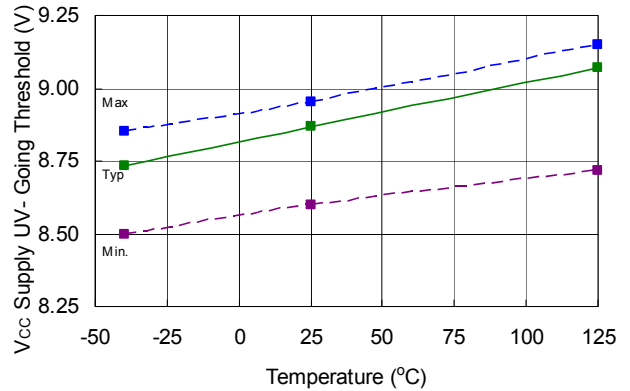

Figure 19: V_{CCUV-} vs. temperature

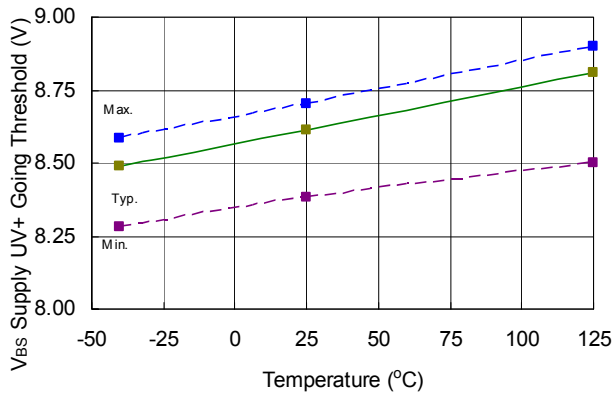

Figure 20: V_{BSUV+} vs. temperature

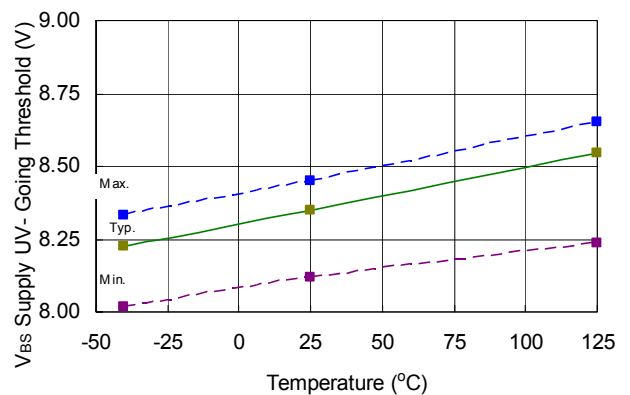

Figure 21: V_{BSUV-} vs. temperature

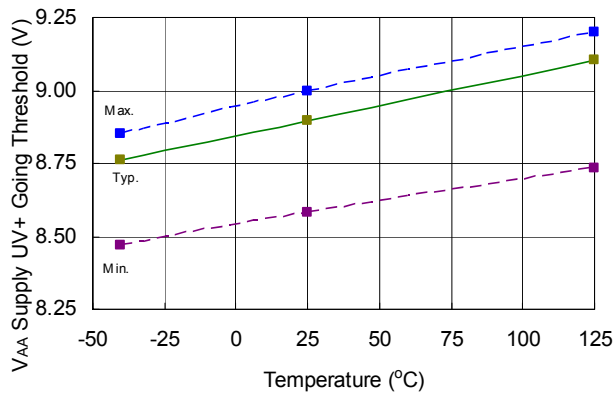

Figure 22: V_{AAUV+} vs. temperature

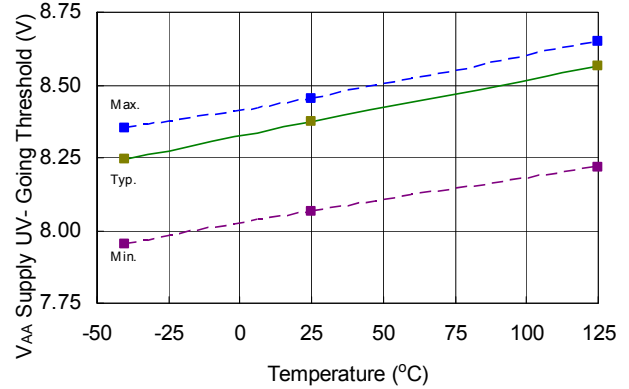

Figure 23: V_{AAUV-} vs. temperature

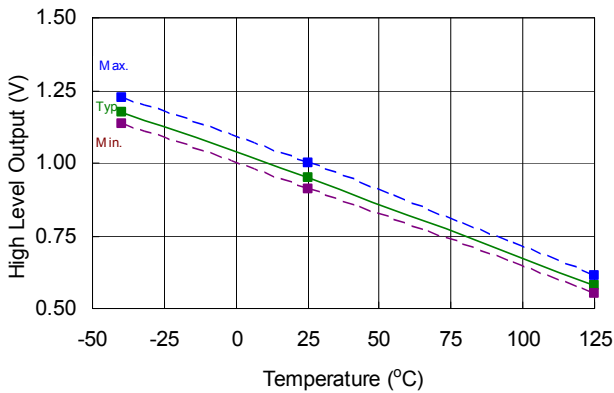

Figure 24: V_{OH} ($I_o = 0A$) vs. temperature

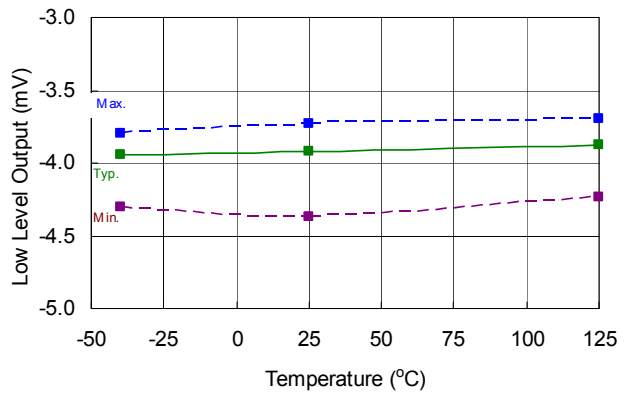

Figure 25: V_{OL} ($I_o = 0A$) vs. temperature

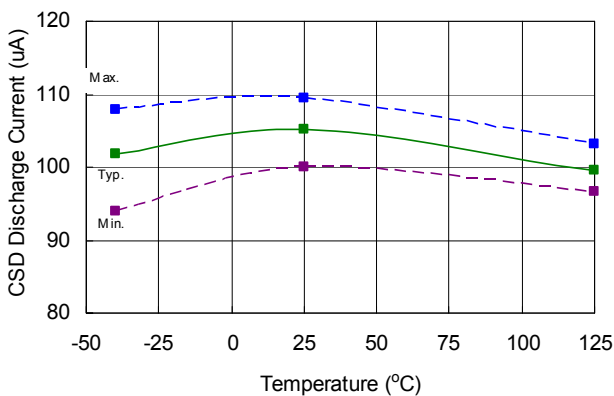

Figure 26: I_{CSD+} vs. temperature

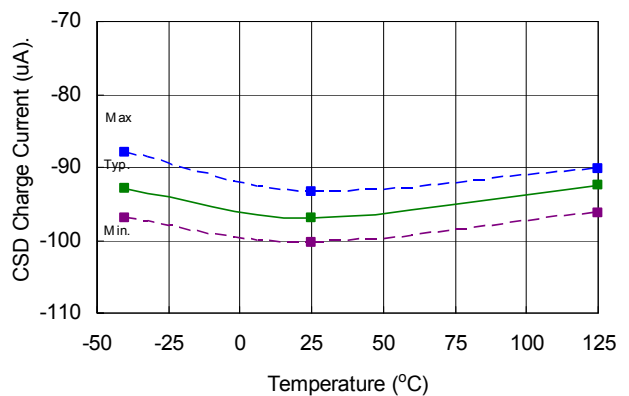

Figure 27: I_{CSD-} vs. temperature

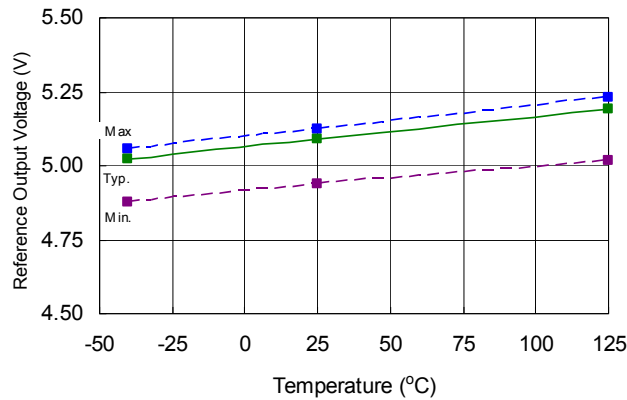
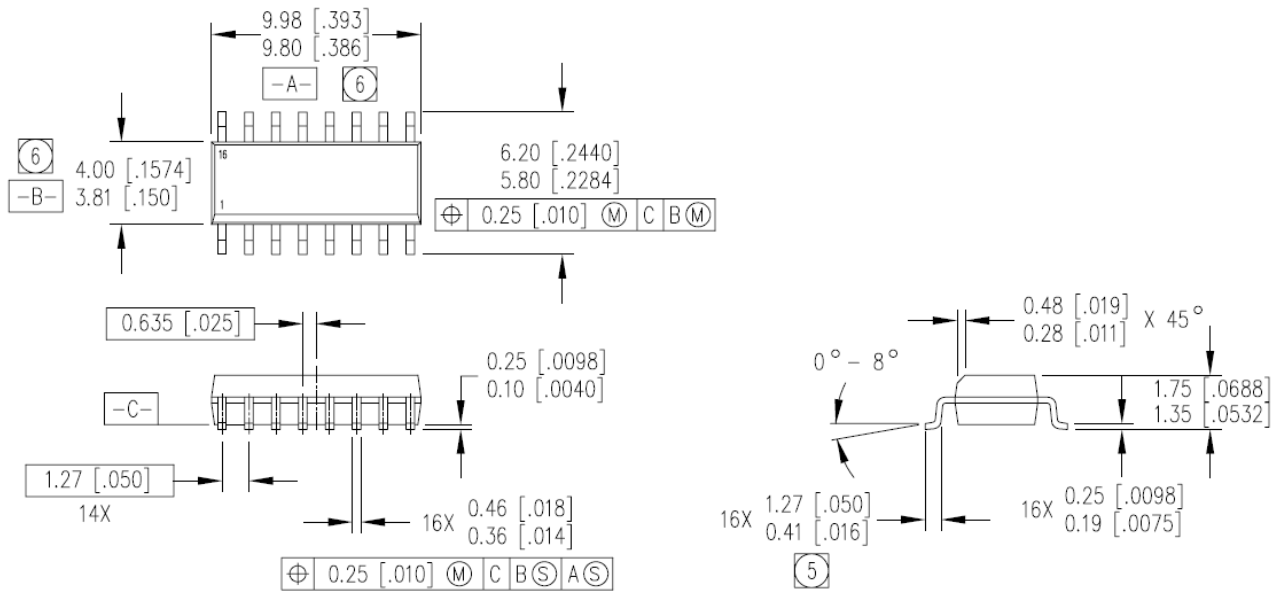

Figure 28: V_{REF} vs. temperature

Package Details: SOIC16N



NOTES:

1. DIMENSIONING & TOLERANCING PER ANSI Y14.5M-1982.
2. CONTROLLING DIMENSION: MILLIMETER
3. DIMENSIONS ARE SHOWN IN MILLIMETERS [INCHES].
4. OUTLINE CONFORMS TO JEDEC OUTLINE MS-012AC.

- (5) DIMENSION IS THE LENGTH OF LEAD FOR SOLDERING TO A SUBSTRATE.
- (6) DIMENSION DOES NOT INCLUDE MOLD PROTUSIONS. MOLD PROTUSIONS SHALL NOT EXCEED 0.15 [.006].

Tape and Reel Details: SOIC16N

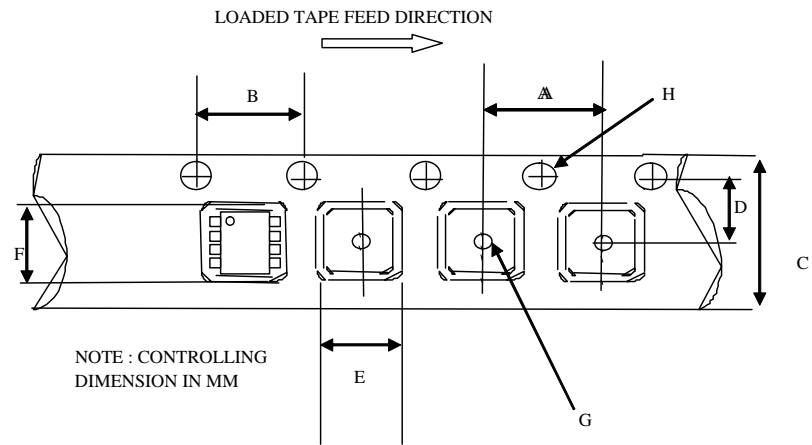

CARRIER TAPE DIMENSION FOR 16SOICN

Code	Metric		Imperial	
	Min	Max	Min	Max
A	7.90	8.10	0.311	0.318
B	3.90	4.10	0.153	0.161
C	15.70	16.30	0.618	0.641
D	7.40	7.60	0.291	0.299
E	6.40	6.60	0.252	0.260
F	10.20	10.40	0.402	0.409
G	1.50	n/a	0.059	n/a
H	1.50	1.60	0.059	0.062

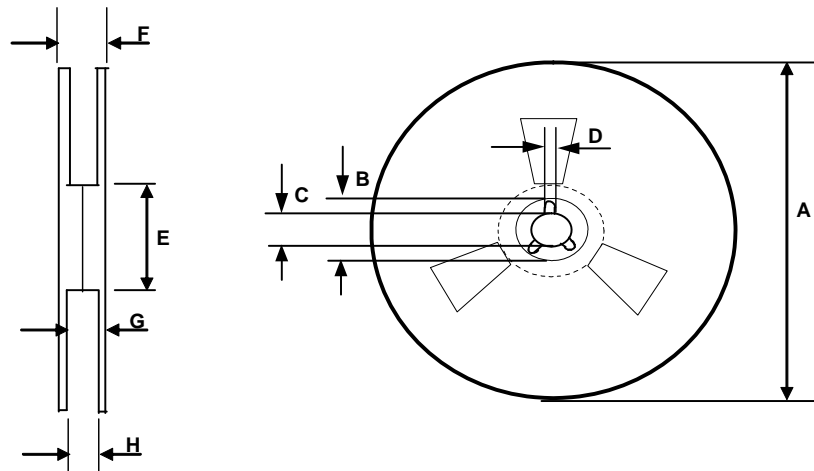

REEL DIMENSIONS FOR 16SOICN

Code	Metric		Imperial	
	Min	Max	Min	Max
A	329.60	330.25	12.976	13.001
B	20.95	21.45	0.824	0.844
C	12.80	13.20	0.503	0.519
D	1.95	2.45	0.767	0.096
E	98.00	102.00	3.858	4.015
F	n/a	22.40	n/a	0.881
G	18.50	21.10	0.728	0.830
H	16.40	18.40	0.645	0.724

Part Marking Information

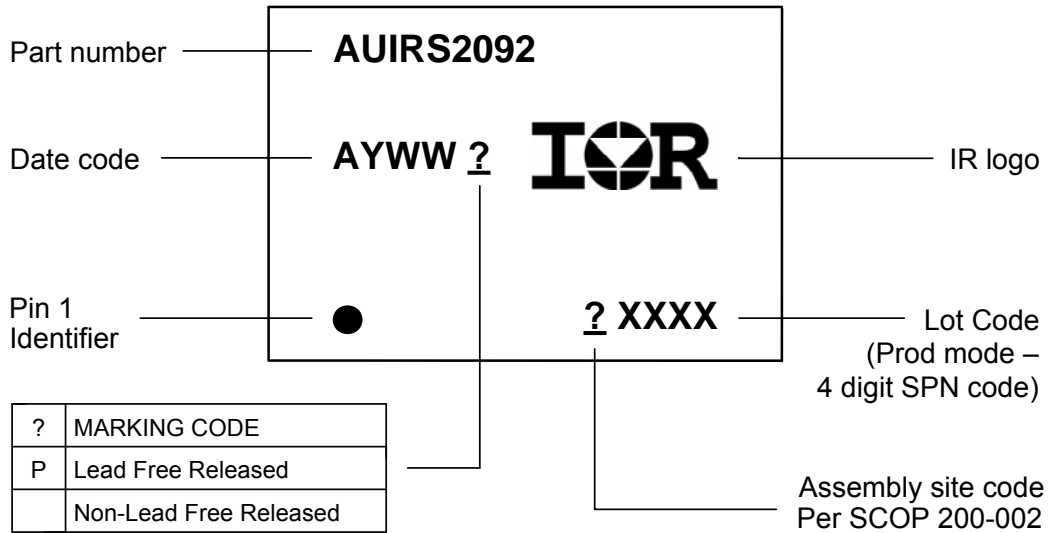

Ordering Information

Base Part Number	Package Type	Standard Pack		Complete Part Number
		Form	Quantity	
AUIRS2092	SOIC16N	Tube/Bulk	45	AUIRS2092S
		Tape and Reel	2500	AUIRS2092STR

IMPORTANT NOTICE

Unless specifically designated for the automotive market, International Rectifier Corporation and its subsidiaries (IR) reserve the right to make corrections, modifications, enhancements, improvements, and other changes to its products and services at any time and to discontinue any product or services without notice. Part numbers designated with the "AU" prefix follow automotive industry and / or customer specific requirements with regards to product discontinuance and process change notification. All products are sold subject to IR's terms and conditions of sale supplied at the time of order acknowledgment.

IR warrants performance of its hardware products to the specifications applicable at the time of sale in accordance with IR's standard warranty. Testing and other quality control techniques are used to the extent IR deems necessary to support this warranty. Except where mandated by government requirements, testing of all parameters of each product is not necessarily performed.

IR assumes no liability for applications assistance or customer product design. Customers are responsible for their products and applications using IR components. To minimize the risks with customer products and applications, customers should provide adequate design and operating safeguards.

Reproduction of IR information in IR data books or data sheets is permissible only if reproduction is without alteration and is accompanied by all associated warranties, conditions, limitations, and notices. Reproduction of this information with alterations is an unfair and deceptive business practice. IR is not responsible or liable for such altered documentation. Information of third parties may be subject to additional restrictions.

Resale of IR products or serviced with statements different from or beyond the parameters stated by IR for that product or service voids all express and any implied warranties for the associated IR product or service and is an unfair and deceptive business practice. IR is not responsible or liable for any such statements.

IR products are not designed, intended, or authorized for use as components in systems intended for surgical implant into the body, or in other applications intended to support or sustain life, or in any other application in which the failure of the IR product could create a situation where personal injury or death may occur. Should Buyer purchase or use IR products for any such unintended or unauthorized application, Buyer shall indemnify and hold International Rectifier and its officers, employees, subsidiaries, affiliates, and distributors harmless against all claims, costs, damages, and expenses, and reasonable attorney fees arising out of, directly or indirectly, any claim of personal injury or death associated with such unintended or unauthorized use, even if such claim alleges that IR was negligent regarding the design or manufacture of the product.

IR products are neither designed nor intended for use in military/aerospace applications or environments unless the IR products are specifically designated by IR as military-grade or "enhanced plastic." Only products designated by IR as military-grade meet military specifications. Buyers acknowledge and agree that any such use of IR products which IR has not designated as military-grade is solely at the Buyer's risk, and that they are solely responsible for compliance with all legal and regulatory requirements in connection with such use.

IR products are neither designed nor intended for use in automotive applications or environments unless the specific IR products are designated by IR as compliant with ISO/TS 16949 requirements and bear a part number including the designation "AU". Buyers acknowledge and agree that, if they use any non-designated products in automotive applications, IR will not be responsible for any failure to meet such requirements.

For technical support, please contact IR's Technical Assistance Center
<http://www.irf.com/technical-info/>

WORLD HEADQUARTERS:
101 N. Sepulveda Blvd., El Segundo, California 90245
Tel: (310) 252-7105

Revision History

Date	Comment
April 30, 2010	Converted from Industrial version
Aug. 5, 2010	Added tri-temp graphs;
Aug. 23, 2010	Updated Iqaa1,2,VOH,VOL,DT1,2,3,4, TOCH,TOCL,VOS, ICSD+/-, VREF, UVAA/CC/BS+/-; added Iqaa1-25,Iqaa2-25,DT1,2,3,4-25 parameters.
Sep. 1, 2010	Corrected DT1-25 max to 35. Added ESD and latchup classification
Jan. 19, 2011	Updated DT1-to-4, Vos, Iqaa1,2 tri-temp spec
Jan. 20, 2011	Added leadfree and automotive grade heading
Jan. 21, 2011	Added typical for IO on front page, merged DT,Vos, Iqaa repeated descriptions.
Mar. 11,2011	Changed notice address

Looking for pricing, stock, or lifecycle information?

Click below to explore more details on WIN SOURCE:

 [View AUIRS2092S](#) on WIN SOURCE

 [Infineon Technologies](#) Information

Optimize Your Supply Chain with WIN SOURCE Solutions

-  Global Sourcing Solution
-  Obsolete Management
-  Cost Control Management
-  Shortage Management
-  Alternative Solution
-  Excess Inventory Management