



**THE DATASHEET OF  
SN74AHC16540DGGR**



# SN54AHC16540, SN74AHC16540 16-BIT BUFFERS/DRIVERS WITH 3-STATE OUTPUTS

SCLS331F – MARCH 1996 – REVISED JANUARY 2000

- **Members of the Texas Instruments Widebus™ Family**
- **EPIC™ (Enhanced-Performance Implanted CMOS) Process**
- **Operating Range 2-V to 5.5-V  $V_{CC}$**
- **Distributed  $V_{CC}$  and GND Pins Minimize High-Speed Switching Noise**
- **Flow-Through Architecture Optimizes PCB Layout**
- **Latch-Up Performance Exceeds 250 mA Per JESD 17**
- **ESD Protection Exceeds 2000 V Per MIL-STD-883, Method 3015**
- **Package Options Include Plastic Shrink Small-Outline (DL), Thin Shrink Small-Outline (DGG), and Thin Very Small-Outline (DGV) Packages and 380-mil Fine-Pitch Ceramic Flat (WD) Package Using 25-mil Center-to-Center Spacings**

SN54AHC16540 . . . WD PACKAGE  
SN74AHC16540 . . . DGG, DGV, OR DL PACKAGE  
(TOP VIEW)

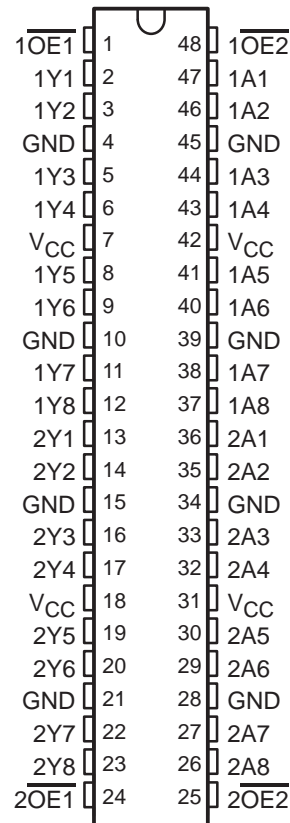

## description

These 16-bit buffers and bus drivers provide a high-performance bus interface for wide data paths.

The 3-state control gate is a 2-input AND gate with active-low inputs so that if either output-enable ( $\overline{OE1}$  or  $\overline{OE2}$ ) input is high, all corresponding outputs are in the high-impedance state.

To ensure the high-impedance state during power up or power down,  $\overline{OE}$  should be tied to  $V_{CC}$  through a pullup resistor; the minimum value of the resistor is determined by the current-sinking capability of the driver.

The SN54AHC16540 is characterized for operation over the full military temperature range of  $-55^{\circ}\text{C}$  to  $125^{\circ}\text{C}$ . The SN74AHC16540 is characterized for operation from  $-40^{\circ}\text{C}$  to  $85^{\circ}\text{C}$ .

FUNCTION TABLE  
(each 8-bit buffer/driver)

INPUTS			OUTPUT Y
$\overline{OE1}$	$\overline{OE2}$	A	
L	L	L	H
L	L	H	L
H	X	X	Z
X	H	X	Z



Please be aware that an important notice concerning availability, standard warranty, and use in critical applications of Texas Instruments semiconductor products and disclaimers thereto appears at the end of this data sheet.

EPIC and Widebus are trademarks of Texas Instruments Incorporated.

UNLESS OTHERWISE NOTED this document contains PRODUCTION DATA information current as of publication date. Products conform to specifications per the terms of Texas Instruments standard warranty. Production processing does not necessarily include testing of all parameters.

 **TEXAS  
INSTRUMENTS**

POST OFFICE BOX 655303 • DALLAS, TEXAS 75265

Copyright © 2000, Texas Instruments Incorporated

# SN54AHC16540, SN74AHC16540

## 16-BIT BUFFERS/DRIVERS

### WITH 3-STATE OUTPUTS

SCLS331F – MARCH 1996 – REVISED JANUARY 2000

#### logic symbol†

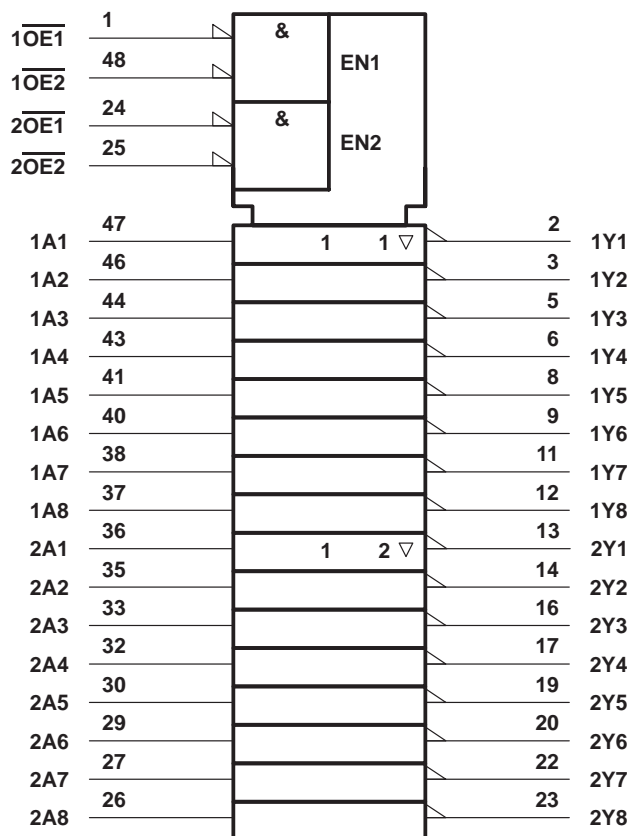

† This symbol is in accordance with ANSI/IEEE Std 91-1984 and IEC Publication 617-12.

#### logic diagram (positive logic)

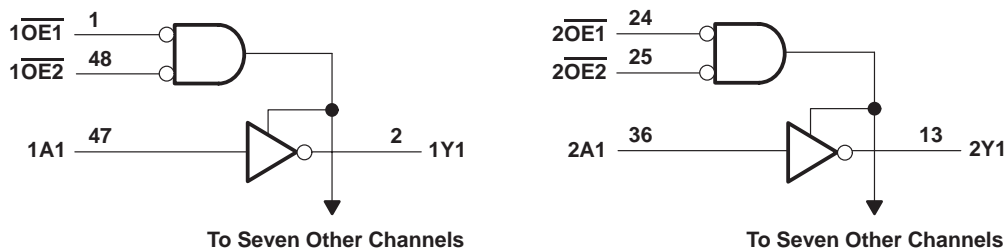



# SN54AHC16540, SN74AHC16540

## 16-BIT BUFFERS/DRIVERS

### WITH 3-STATE OUTPUTS

SCLS331F – MARCH 1996 – REVISED JANUARY 2000

electrical characteristics over recommended operating free-air temperature range (unless otherwise noted)

PARAMETER	TEST CONDITIONS	V <sub>CC</sub>	T <sub>A</sub> = 25°C			SN54AHC16540		SN74AHC16540		UNIT
			MIN	TYP	MAX	MIN	MAX	MIN	MAX	
V <sub>OH</sub>	I <sub>OH</sub> = -50 μA	2 V	1.9	2		1.9		1.9	V	
		3 V	2.9	3		2.9		2.9		
		4.5 V	4.4	4.5		4.4		4.4		
	I <sub>OH</sub> = -4 mA	3 V	2.58			2.48		2.48		
	I <sub>OH</sub> = -8 mA	4.5 V	3.94			3.8		3.8		
V <sub>OL</sub>	I <sub>OL</sub> = 50 μA	2 V			0.1		0.1		V	
		3 V			0.1		0.1			
		4.5 V			0.1		0.1			
	I <sub>OL</sub> = 4 mA	3 V			0.36		0.5	0.44		
	I <sub>OL</sub> = 8 mA	4.5 V			0.36		0.5	0.44		
I <sub>I</sub>	V <sub>I</sub> = V <sub>CC</sub> or GND	0 V to 5.5 V			±0.1		±1*		μA	
I <sub>OZ</sub>	V <sub>O</sub> = V <sub>CC</sub> or GND, V <sub>I</sub> (OE) = V <sub>IL</sub> or V <sub>IH</sub>	5.5 V			±0.25		±2.5		μA	
I <sub>CC</sub>	V <sub>I</sub> = V <sub>CC</sub> or GND, I <sub>O</sub> = 0	5.5 V			4		40		μA	
C <sub>i</sub>	V <sub>I</sub> = V <sub>CC</sub> or GND	5 V		2	10				10	pF
C <sub>o</sub>	V <sub>O</sub> = V <sub>CC</sub> or GND	5 V		3						pF

\* On products compliant to MIL-PRF-38535, this parameter is not production tested at V<sub>CC</sub> = 0 V.

switching characteristics over recommended operating free-air temperature range, V<sub>CC</sub> = 3.3 V ± 0.3 V (unless otherwise noted) (see Figure 1)

PARAMETER	FROM (INPUT)	TO (OUTPUT)	LOAD CAPACITANCE	T <sub>A</sub> = 25°C			SN54AHC16540		SN74AHC16540		UNIT
				MIN	TYP	MAX	MIN	MAX	MIN	MAX	
t <sub>PLH</sub>	A	Y	C <sub>L</sub> = 15 pF		4.8**	8.4**	1**	10**	1	10	ns
t <sub>PHL</sub>											
t <sub>PZH</sub>	$\overline{\text{OE}}$	Y	C <sub>L</sub> = 15 pF		6.8**	10.6**	1**	12.5**	1	12.5	ns
t <sub>PZL</sub>											
t <sub>PHZ</sub>	$\overline{\text{OE}}$	Y	C <sub>L</sub> = 15 pF		6.8**	11.5**	1**	12.5**	1	12.5	ns
t <sub>PLZ</sub>											
t <sub>PLH</sub>	A	Y	C <sub>L</sub> = 50 pF		7.7	11	1	12.5	1	12.5	ns
t <sub>PHL</sub>											
t <sub>PZH</sub>	$\overline{\text{OE}}$	Y	C <sub>L</sub> = 50 pF		9.7	14.1	1	16	1	16	ns
t <sub>PZL</sub>											
t <sub>PHZ</sub>	$\overline{\text{OE}}$	Y	C <sub>L</sub> = 50 pF		9.4	14	1	16	1	16	ns
t <sub>PLZ</sub>											
t <sub>sk(o)</sub>			C <sub>L</sub> = 50 pF			1.5***				1.5	ns

\*\* On products compliant to MIL-PRF-38535, this parameter is not production tested.

\*\*\* On products compliant to MIL-PRF-38535, this parameter does not apply.

PRODUCT PREVIEW information concerns products in the formative or design phase of development. Characteristic data and other specifications are design goals. Texas Instruments reserves the right to change or discontinue these products without notice.



POST OFFICE BOX 655303 • DALLAS, TEXAS 75265

SN54AHC16540, SN74AHC16540  
16-BIT BUFFERS/DRIVERS  
WITH 3-STATE OUTPUTS

SCLS331F – MARCH 1996 – REVISED JANUARY 2000

switching characteristics over recommended operating free-air temperature range,  
 $V_{CC} = 5\text{ V} \pm 0.5\text{ V}$  (unless otherwise noted) (see Figure 1)

PARAMETER	FROM (INPUT)	TO (OUTPUT)	LOAD CAPACITANCE	$T_A = 25^\circ\text{C}$			SN54AHC16540		SN74AHC16540		UNIT
				MIN	TYP	MAX	MIN	MAX	MIN	MAX	
$t_{PLH}$	A	Y	$C_L = 15\text{ pF}$	3.7*	6*	1*	7*	1	7	ns	
$t_{PHL}$				3.7*	6*	1*	7*	1	7		
$t_{PZH}$	$\overline{OE}$	Y	$C_L = 15\text{ pF}$	4.7*	7.3*	1*	8.5*	1	8.5	ns	
$t_{PZL}$				4.7*	7.3*	1*	8.5*	1	8.5		
$t_{PHZ}$	$\overline{OE}$	Y	$C_L = 15\text{ pF}$	4.5*	7.2*	1*	8.5*	1	8.5	ns	
$t_{PLZ}$				4.5*	7.2*	1*	8.5*	1	8.5		
$t_{PLH}$	A	Y	$C_L = 50\text{ pF}$	5.2	8	1	9	1	8.5	ns	
$t_{PHL}$				5.2	8	1	9	1	8.5		
$t_{PZH}$	$\overline{OE}$	Y	$C_L = 50\text{ pF}$	6.2	9.3	1	10.5	1	10.5	ns	
$t_{PZL}$				6.2	9.3	1	10.5	1	10.5		
$t_{PHZ}$	$\overline{OE}$	Y	$C_L = 50\text{ pF}$	6	9.2	1	10.5	1	10.5	ns	
$t_{PLZ}$				6	9.2	1	10.5	1	10.5		
$t_{sk(o)}$			$C_L = 50\text{ pF}$		1**				1	ns	

\* On products compliant to MIL-PRF-38535, this parameter is not production tested.

\*\* On products compliant to MIL-PRF-38535, this parameter does not apply.

noise characteristics,  $V_{CC} = 5\text{ V}$ ,  $C_L = 50\text{ pF}$ ,  $T_A = 25^\circ\text{C}$  (see Note 4)

PARAMETER		SN74AHC16540			UNIT
		MIN	TYP	MAX	
$V_{OL(P)}$	Quiet output, maximum dynamic $V_{OL}$		0.6		V
$V_{OL(V)}$	Quiet output, minimum dynamic $V_{OL}$		-0.3		V
$V_{OH(V)}$	Quiet output, minimum dynamic $V_{OH}$		4.7		V
$V_{IH(D)}$	High-level dynamic input voltage	3.5			V
$V_{IL(D)}$	Low-level dynamic input voltage			1.5	V

NOTE 4: Characteristics are for surface-mount packages only.

operating characteristics,  $V_{CC} = 5\text{ V}$ ,  $T_A = 25^\circ\text{C}$

PARAMETER		TEST CONDITIONS	TYP	UNIT
$C_{pd}$	Power dissipation capacitance	No load, $f = 1\text{ MHz}$	13	pF

PRODUCT PREVIEW information concerns products in the formative or design phase of development. Characteristic data and other specifications are design goals. Texas Instruments reserves the right to change or discontinue these products without notice.



POST OFFICE BOX 655303 • DALLAS, TEXAS 75265

# SN54AHC16540, SN74AHC16540 16-BIT BUFFERS/DRIVERS WITH 3-STATE OUTPUTS

SCLS331F – MARCH 1996 – REVISED JANUARY 2000

## PARAMETER MEASUREMENT INFORMATION

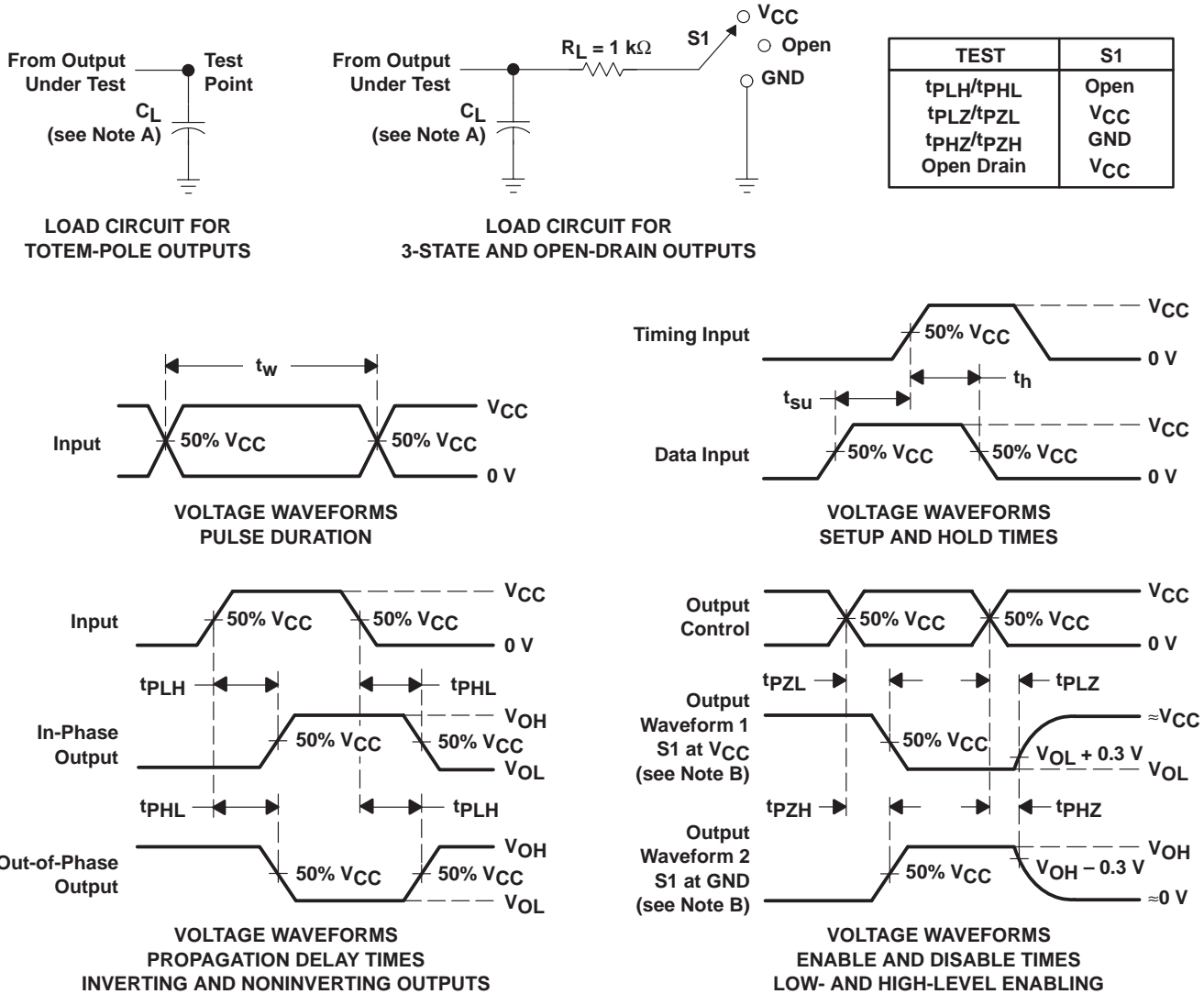

- NOTES:
- A.  $C_L$  includes probe and jig capacitance.
  - B. Waveform 1 is for an output with internal conditions such that the output is low except when disabled by the output control. Waveform 2 is for an output with internal conditions such that the output is high except when disabled by the output control.
  - C. All input pulses are supplied by generators having the following characteristics:  $PRR \leq 1\text{ MHz}$ ,  $Z_O = 50\ \Omega$ ,  $t_r \leq 3\text{ ns}$ ,  $t_f \leq 3\text{ ns}$ .
  - D. The outputs are measured one at a time with one input transition per measurement.

Figure 1. Load Circuit and Voltage Waveforms

**PACKAGING INFORMATION**

Orderable Device	Status (1)	Package Type	Package Drawing	Pins	Package Qty	Eco Plan (2)	Lead finish/ Ball material (6)	MSL Peak Temp (3)	Op Temp (°C)	Device Marking (4/5)	Samples
SN74AHC16540DGGR	ACTIVE	TSSOP	DGG	48	2000	RoHS & Green	NIPDAU	Level-1-260C-UNLIM	-40 to 85	AHC16540	<a href="#">Samples</a>
SN74AHC16540DL	ACTIVE	SSOP	DL	48	25	RoHS & Green	NIPDAU	Level-1-260C-UNLIM	-40 to 85	AHC16540	<a href="#">Samples</a>

(1) The marketing status values are defined as follows:

**ACTIVE:** Product device recommended for new designs.

**LIFEBUY:** TI has announced that the device will be discontinued, and a lifetime-buy period is in effect.

**NRND:** Not recommended for new designs. Device is in production to support existing customers, but TI does not recommend using this part in a new design.

**PREVIEW:** Device has been announced but is not in production. Samples may or may not be available.

**OBSOLETE:** TI has discontinued the production of the device.

(2) **RoHS:** TI defines "RoHS" to mean semiconductor products that are compliant with the current EU RoHS requirements for all 10 RoHS substances, including the requirement that RoHS substance do not exceed 0.1% by weight in homogeneous materials. Where designed to be soldered at high temperatures, "RoHS" products are suitable for use in specified lead-free processes. TI may reference these types of products as "Pb-Free".

**RoHS Exempt:** TI defines "RoHS Exempt" to mean products that contain lead but are compliant with EU RoHS pursuant to a specific EU RoHS exemption.

**Green:** TI defines "Green" to mean the content of Chlorine (Cl) and Bromine (Br) based flame retardants meet JS709B low halogen requirements of <=1000ppm threshold. Antimony trioxide based flame retardants must also meet the <=1000ppm threshold requirement.

(3) MSL, Peak Temp. - The Moisture Sensitivity Level rating according to the JEDEC industry standard classifications, and peak solder temperature.

(4) There may be additional marking, which relates to the logo, the lot trace code information, or the environmental category on the device.

(5) Multiple Device Markings will be inside parentheses. Only one Device Marking contained in parentheses and separated by a "~" will appear on a device. If a line is indented then it is a continuation of the previous line and the two combined represent the entire Device Marking for that device.

(6) Lead finish/Ball material - Orderable Devices may have multiple material finish options. Finish options are separated by a vertical ruled line. Lead finish/Ball material values may wrap to two lines if the finish value exceeds the maximum column width.

**Important Information and Disclaimer:**The information provided on this page represents TI's knowledge and belief as of the date that it is provided. TI bases its knowledge and belief on information provided by third parties, and makes no representation or warranty as to the accuracy of such information. Efforts are underway to better integrate information from third parties. TI has taken and continues to take reasonable steps to provide representative and accurate information but may not have conducted destructive testing or chemical analysis on incoming materials and chemicals. TI and TI suppliers consider certain information to be proprietary, and thus CAS numbers and other limited information may not be available for release.

In no event shall TI's liability arising out of such information exceed the total purchase price of the TI part(s) at issue in this document sold by TI to Customer on an annual basis.



**TAPE AND REEL INFORMATION**

**QUADRANT ASSIGNMENTS FOR PIN 1 ORIENTATION IN TAPE**

\*All dimensions are nominal

Device	Package Type	Package Drawing	Pins	SPQ	Reel Diameter (mm)	Reel Width W1 (mm)	A0 (mm)	B0 (mm)	K0 (mm)	P1 (mm)	W (mm)	Pin1 Quadrant
SN74AHC16540DGGR	TSSOP	DGG	48	2000	330.0	24.4	8.6	13.0	1.8	12.0	24.0	Q1

**TAPE AND REEL BOX DIMENSIONS**

\*All dimensions are nominal

Device	Package Type	Package Drawing	Pins	SPQ	Length (mm)	Width (mm)	Height (mm)
SN74AHC16540DGGR	TSSOP	DGG	48	2000	367.0	367.0	45.0

**TUBE**

\*All dimensions are nominal

Device	Package Name	Package Type	Pins	SPQ	L (mm)	W (mm)	T (μm)	B (mm)
SN74AHC16540DL	DL	SSOP	48	25	473.7	14.24	5110	7.87



# EXAMPLE BOARD LAYOUT

DGG0048A

TSSOP - 1.2 mm max height

SMALL OUTLINE PACKAGE

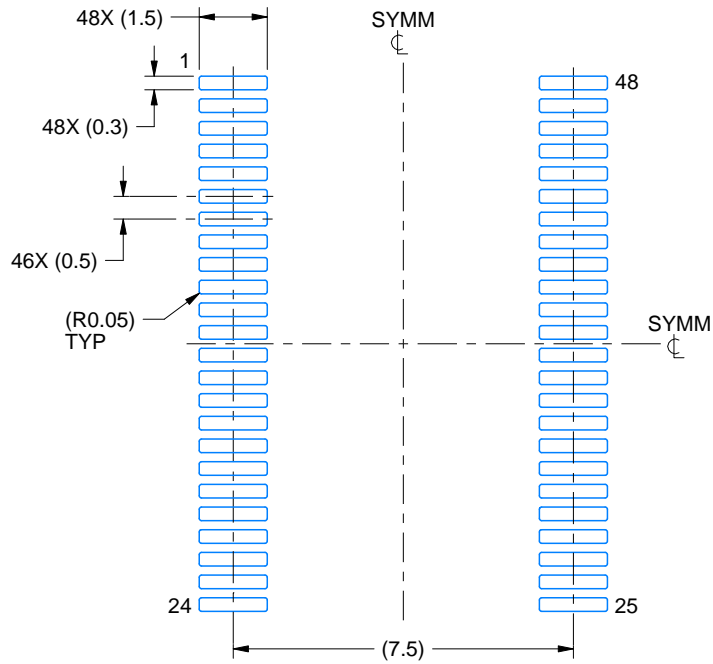

LAND PATTERN EXAMPLE  
SCALE:6X

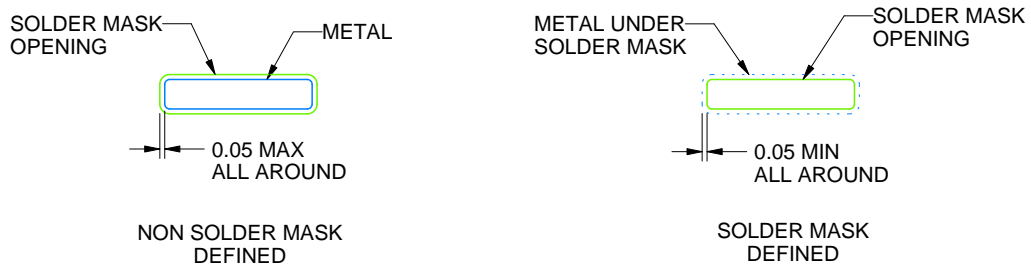

SOLDER MASK DETAILS

4214859/B 11/2020

NOTES: (continued)

- 5. Publication IPC-7351 may have alternate designs.
- 6. Solder mask tolerances between and around signal pads can vary based on board fabrication site.

# EXAMPLE STENCIL DESIGN

DGG0048A

TSSOP - 1.2 mm max height

SMALL OUTLINE PACKAGE



SOLDER PASTE EXAMPLE  
BASED ON 0.125 mm THICK STENCIL  
SCALE:6X

4214859/B 11/2020

NOTES: (continued)

7. Laser cutting apertures with trapezoidal walls and rounded corners may offer better paste release. IPC-7525 may have alternate design recommendations.
8. Board assembly site may have different recommendations for stencil design.

DGG (R-PDSO-G\*\*)

PLASTIC SMALL-OUTLINE PACKAGE

48 PINS SHOWN



- NOTES: A. All linear dimensions are in millimeters.  
 B. This drawing is subject to change without notice.  
 C. Body dimensions do not include mold protrusion not to exceed 0,15.  
 D. Falls within JEDEC MO-153

# MECHANICAL DATA

DL (R-PDSO-G48)

PLASTIC SMALL-OUTLINE PACKAGE

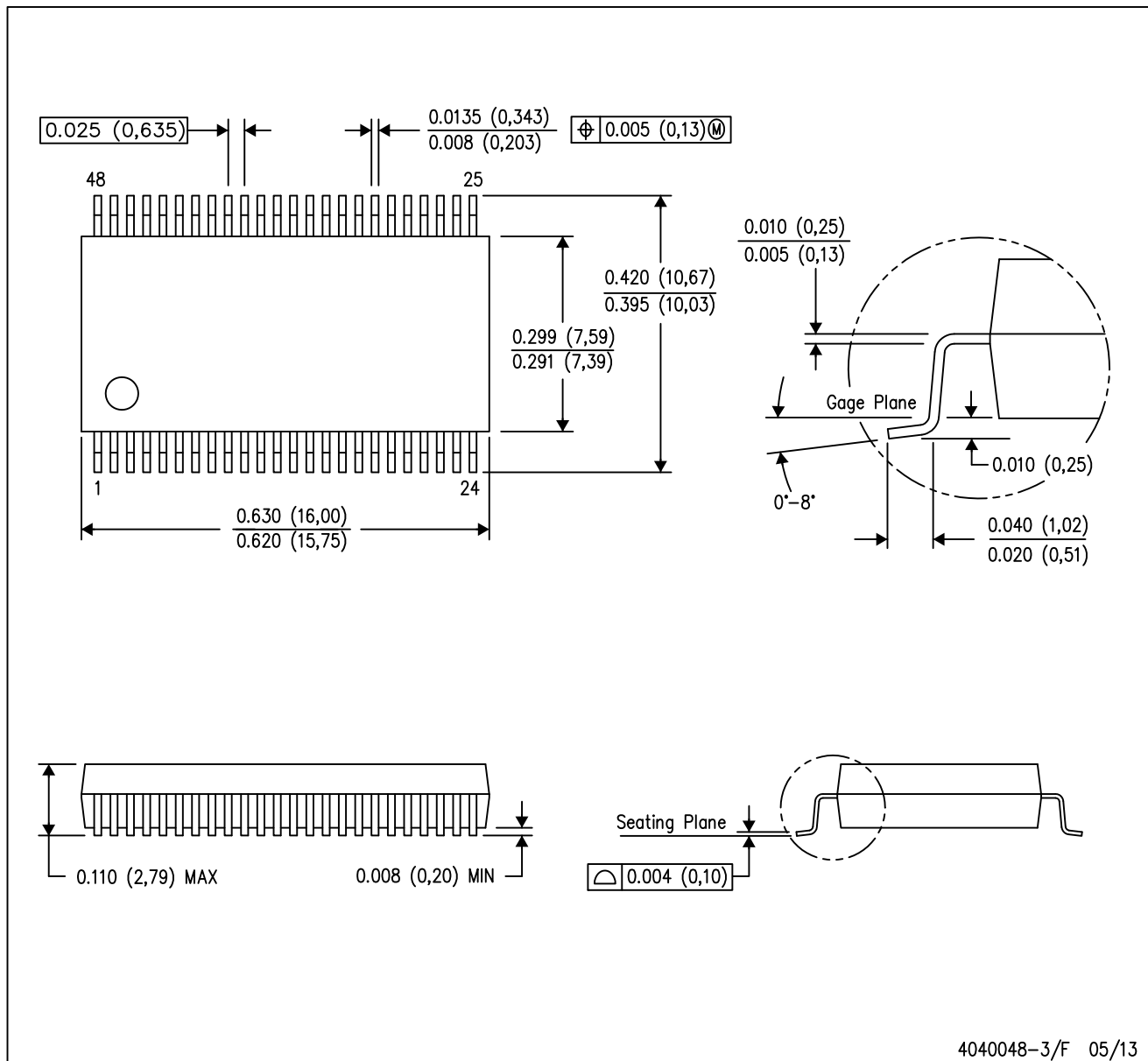

- NOTES:
- All linear dimensions are in inches (millimeters).
  - This drawing is subject to change without notice.
  - Body dimensions do not include mold flash or protrusion not to exceed 0.006 (0,15).
  - Falls within JEDEC MO-118

PowerPAD is a trademark of Texas Instruments.

## IMPORTANT NOTICE AND DISCLAIMER

TI PROVIDES TECHNICAL AND RELIABILITY DATA (INCLUDING DATA SHEETS), DESIGN RESOURCES (INCLUDING REFERENCE DESIGNS), APPLICATION OR OTHER DESIGN ADVICE, WEB TOOLS, SAFETY INFORMATION, AND OTHER RESOURCES "AS IS" AND WITH ALL FAULTS, AND DISCLAIMS ALL WARRANTIES, EXPRESS AND IMPLIED, INCLUDING WITHOUT LIMITATION ANY IMPLIED WARRANTIES OF MERCHANTABILITY, FITNESS FOR A PARTICULAR PURPOSE OR NON-INFRINGEMENT OF THIRD PARTY INTELLECTUAL PROPERTY RIGHTS.

These resources are intended for skilled developers designing with TI products. You are solely responsible for (1) selecting the appropriate TI products for your application, (2) designing, validating and testing your application, and (3) ensuring your application meets applicable standards, and any other safety, security, regulatory or other requirements.

These resources are subject to change without notice. TI grants you permission to use these resources only for development of an application that uses the TI products described in the resource. Other reproduction and display of these resources is prohibited. No license is granted to any other TI intellectual property right or to any third party intellectual property right. TI disclaims responsibility for, and you will fully indemnify TI and its representatives against, any claims, damages, costs, losses, and liabilities arising out of your use of these resources.

TI's products are provided subject to [TI's Terms of Sale](#) or other applicable terms available either on [ti.com](http://ti.com) or provided in conjunction with such TI products. TI's provision of these resources does not expand or otherwise alter TI's applicable warranties or warranty disclaimers for TI products.

TI objects to and rejects any additional or different terms you may have proposed.

Mailing Address: Texas Instruments, Post Office Box 655303, Dallas, Texas 75265  
Copyright © 2022, Texas Instruments Incorporated

## Looking for pricing, stock, or lifecycle information?

Click below to explore more details on WIN SOURCE:

 [View SN74AHC16540DGGR on WIN SOURCE](#)

 [Texas Instruments](#) Information

## Optimize Your Supply Chain with WIN SOURCE Solutions

-  Global Sourcing Solution
-  Obsolete Management
-  Cost Control Management
-  Shortage Management
-  Alternative Solution
-  Excess Inventory Management