



**THE DATASHEET OF
SN74ABT3612-20PQ**



CLOCKED BIDIRECTIONAL FIRST-IN, FIRST-OUT MEMORY

SCBS129G – JULY 1992 – REVISED APRIL 1998

- Free-Running CLKA and CLKB Can Be Asynchronous or Coincident
- Two Independent 64 × 36 Clocked FIFOs Buffering Data in Opposite Directions
- Mailbox-Bypass Register for Each FIFO
- Programmable Almost-Full and Almost-Empty Flags
- Microprocessor Interface Control Logic
- $\overline{\text{EFA}}$, $\overline{\text{FFA}}$, $\overline{\text{AEA}}$, and $\overline{\text{AFA}}$ Flags Synchronized by CLKA
- $\overline{\text{EFB}}$, $\overline{\text{FFB}}$, $\overline{\text{AEB}}$, and $\overline{\text{AFB}}$ Flags Synchronized by CLKB
- Passive Parity Checking on Each Port
- Parity Generation Can Be Selected for Each Port
- Low-Power Advanced BiCMOS Technology
- Supports Clock Frequencies up to 67 MHz
- Fast Access Times of 10 ns
- Package Options Include 120-Pin Thin Quad Flat (PCB) and 132-Pin Plastic Quad Flat (PQ) Packages

description

The SN74ABT3612 is a high-speed, low-power BiCMOS bidirectional clocked FIFO memory. It supports clock frequencies up to 67 MHz and has read access times as fast as 10 ns. Two independent 64 × 36 dual-port SRAM FIFOs in this device buffer data in opposite directions. Each FIFO has flags to indicate empty and full conditions and two programmable flags (almost-full and almost-empty) to indicate when a selected number of words is stored in memory. Communication between each port can bypass the FIFOs via two 36-bit mailbox registers. Each mailbox register has a flag to signal when new mail has been stored. Parity is checked passively on each port and can be ignored if not desired. Parity generation can be selected for data read from each port. Two or more devices can be used in parallel to create wider datapaths.

The SN74ABT3612 is a clocked FIFO, which means each port employs a synchronous interface. All data transfers through a port are gated to the low-to-high transition of a port clock by enable signals. The clocks for each port are independent of one another and can be asynchronous or coincident. The enables for each port are arranged to provide a simple bidirectional interface between microprocessors and/or buses with synchronous control.

The full flag ($\overline{\text{FFA}}$, $\overline{\text{FFB}}$) and almost-full ($\overline{\text{AFA}}$, $\overline{\text{AFB}}$) flag of a FIFO are two-stage synchronized to the port clock that writes data to its array. The empty flag ($\overline{\text{EFA}}$, $\overline{\text{EFB}}$) and almost-empty ($\overline{\text{AEA}}$, $\overline{\text{AEB}}$) flag of a FIFO are two-stage synchronized to the port clock that reads data from its array.

The SN74ABT3612 is characterized for operation from 0°C to 70°C.

For more information on this device family, see the following application reports:

- *FIFO Mailbox-Bypass Registers: Using Bypass Registers to Initialize DMA Control (literature number SCAA007)*
- *Parity-Generate and Parity-Check Features for High-Bandwidth-Computing FIFO Applications (literature number SCAA015)*
- *Metastability Performance of Clocked FIFOs (literature number SCZA004)*



Please be aware that an important notice concerning availability, standard warranty, and use in critical applications of Texas Instruments semiconductor products and disclaimers thereto appears at the end of this data sheet.

PRODUCTION DATA information is current as of publication date. Products conform to specifications per the terms of Texas Instruments standard warranty. Production processing does not necessarily include testing of all parameters.

 **TEXAS
INSTRUMENTS**

POST OFFICE BOX 655303 • DALLAS, TEXAS 75265

Copyright © 1998, Texas Instruments Incorporated

SN74ABT3612

64 × 36 × 2

CLOCKED BIDIRECTIONAL FIRST-IN, FIRST-OUT MEMORY

SCBS129G – JULY 1992 – REVISED APRIL 1998

PCB PACKAGE
(TOP VIEW)

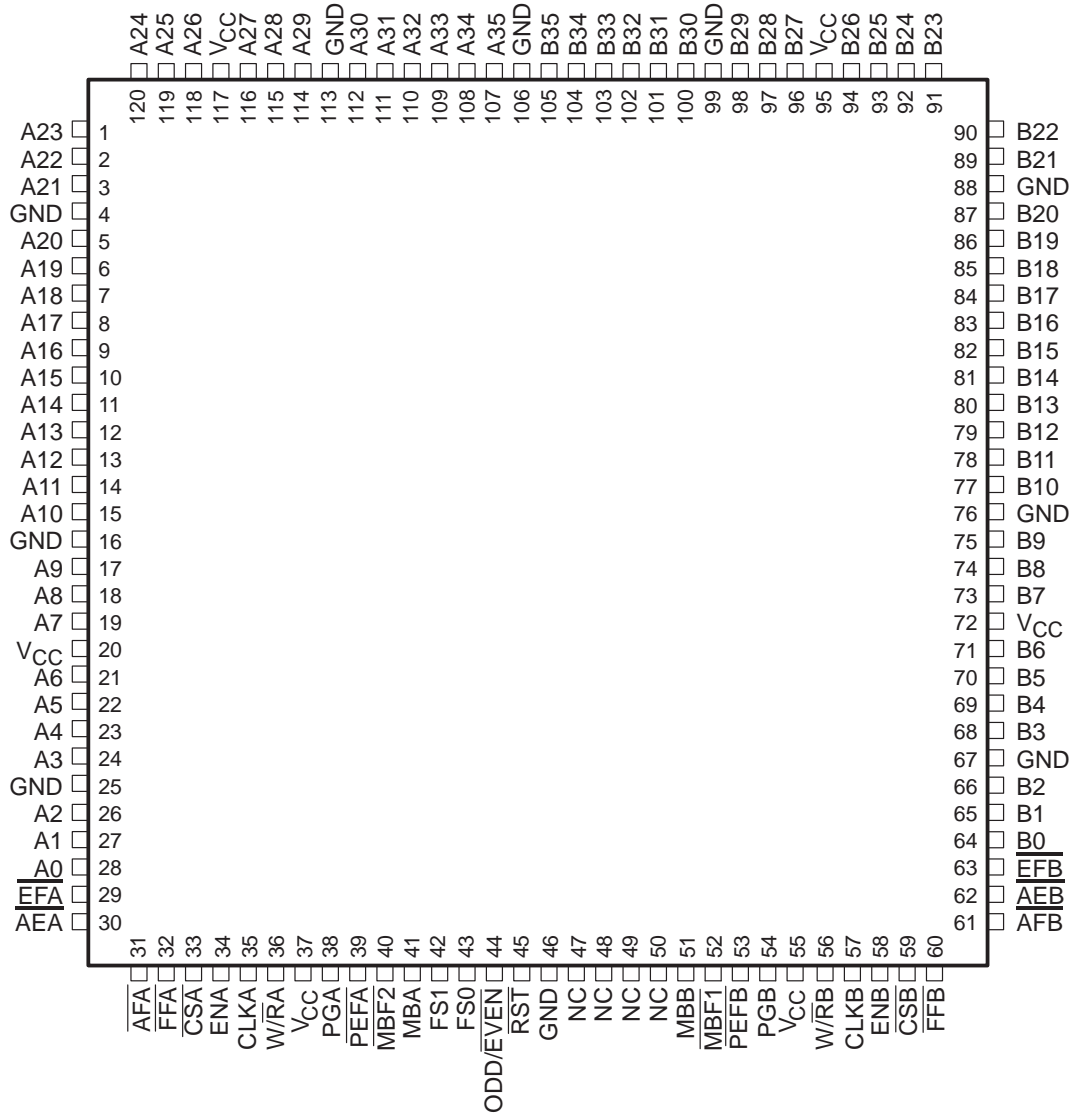

NC – No internal connection



POST OFFICE BOX 655303 • DALLAS, TEXAS 75265

CLOCKED BIDIRECTIONAL FIRST-IN, FIRST-OUT MEMORY

SCBS129G – JULY 1992 – REVISED APRIL 1998

PQ PACKAGE†
(TOP VIEW)

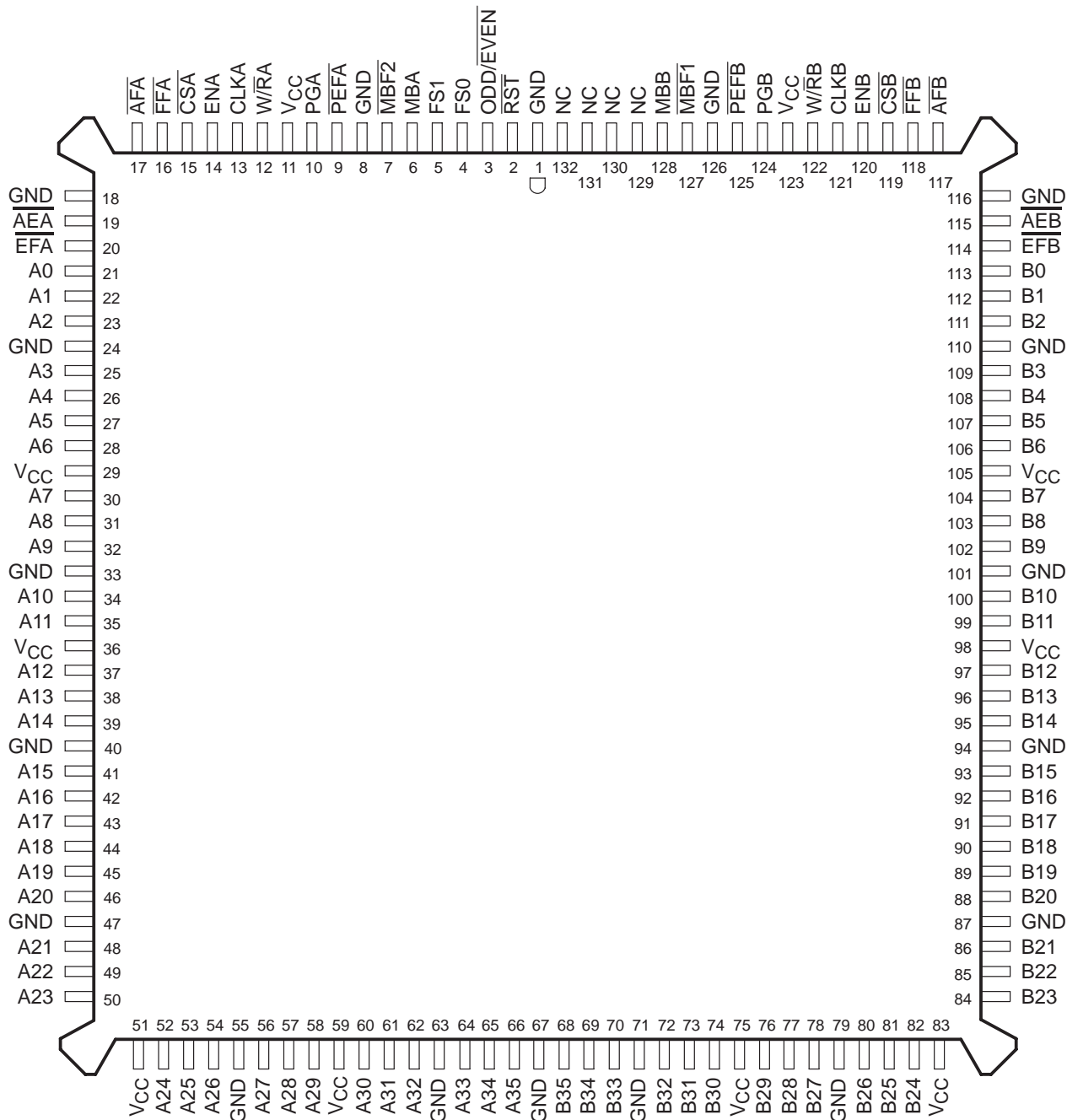

NC – No internal connection
† Uses Yamaichi socket IC51-1324-828

SN74ABT3612

64 × 36 × 2

CLOCKED BIDIRECTIONAL FIRST-IN, FIRST-OUT MEMORY

SCBS129G – JULY 1992 – REVISED APRIL 1998

functional block diagram

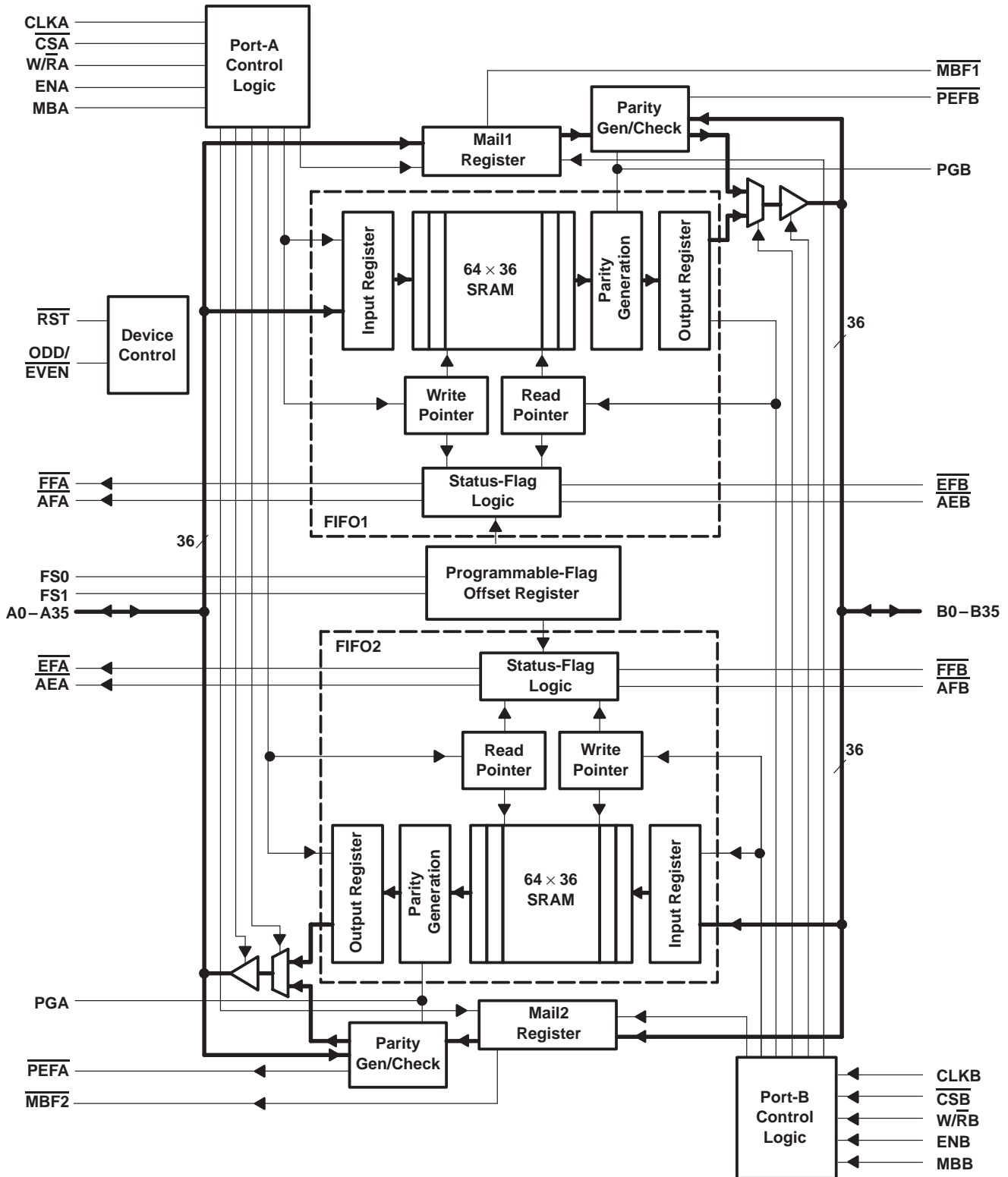

CLOCKED BIDIRECTIONAL FIRST-IN, FIRST-OUT MEMORY

SCBS129G – JULY 1992 – REVISED APRIL 1998

Terminal Functions

PIN NAME	I/O	DESCRIPTION
A0–A35	I/O	Port-A data. The 36-bit bidirectional data port for side A.
AEA	O (port A)	Port-A almost-empty flag. Programmable flag synchronized to CLKA. \overline{AEA} is low when the number of words in FIFO2 is less than or equal to the value in offset register X.
AEB	O (port B)	Port-B almost-empty flag. Programmable flag synchronized to CLKB. \overline{AEB} is low when the number of words in FIFO1 is less than or equal to the value in offset register X.
AFA	O (port A)	Port-A almost-full flag. Programmable flag synchronized to CLKA. \overline{AFA} is low when the number of empty locations in FIFO1 is less than or equal to the value in offset register X.
AFB	O (port B)	Port-B almost-full flag. Programmable flag synchronized to CLKB. \overline{AFB} is low when the number of empty locations in FIFO2 is less than or equal to the value in offset register X.
B0–B35	I/O	Port-B data. The 36-bit bidirectional data port for side B.
CLKA	I	Port-A clock. CLKA is a continuous clock that synchronizes all data transfers through port A and can be asynchronous or coincident to CLKB. \overline{EFA} , \overline{FFA} , \overline{AFA} , and \overline{AEA} are synchronized to the low-to-high transition of CLKA.
CLKB	I	Port-B clock. CLKB is a continuous clock that synchronizes all data transfers through port B and can be asynchronous or coincident to CLKA. \overline{EFB} , \overline{FFB} , \overline{AFB} , and \overline{AEB} are synchronized to the low-to-high transition of CLKB.
CSA	I	Port-A chip select. \overline{CSA} must be low to enable a low-to-high transition of CLKA to read or write data on port A. The A0–A35 outputs are in the high-impedance state when CSA is high.
CSB	I	Port-B chip select. \overline{CSB} must be low to enable a low-to-high transition of CLKB to read or write data on port B. The B0–B35 outputs are in the high-impedance state when CSB is high.
\overline{EFA}	O (port A)	Port-A empty flag. \overline{EFA} is synchronized to the low-to-high transition of CLKA. When \overline{EFA} is low, FIFO2 is empty and reads from its memory are disabled. Data can be read from FIFO2 to the output register when \overline{EFA} is high. \overline{EFA} is forced low when the device is reset and is set high by the second low-to-high transition of CLKA after data is loaded into empty FIFO2 memory.
\overline{EFB}	O (port B)	Port-B empty flag. \overline{EFB} is synchronized to the low-to-high transition of CLKB. When \overline{EFB} is low, FIFO1 is empty and reads from its memory are disabled. Data can be read from FIFO1 to the output register when \overline{EFB} is high. \overline{EFB} is forced low when the device is reset and is set high by the second low-to-high transition of CLKB after data is loaded into empty FIFO1 memory.
ENA	I	Port-A enable. ENA must be high to enable a low-to-high transition of CLKA to read or write data on port A.
ENB	I	Port-B enable. ENB must be high to enable a low-to-high transition of CLKB to read or write data on port B.
FFA	O (port A)	Port-A full flag. \overline{FFA} is synchronized to the low-to-high transition of CLKA. When \overline{FFA} is low, FIFO1 is full and writes to its memory are disabled. \overline{FFA} is forced low when the device is reset and is set high by the second low-to-high transition of CLKA after reset.
FFB	O (port B)	Port-B full flag. \overline{FFB} is synchronized to the low-to-high transition of CLKB. When \overline{FFB} is low, FIFO2 is full and writes to its memory are disabled. \overline{FFB} is forced low when the device is reset and is set high by the second low-to-high transition of CLKB after reset.
FS1, FS0	I	Flag-offset selects. The low-to-high transition of \overline{RST} latches the values of FS0 and FS1, which selects one of four preset values for the almost-empty flag and almost-full flag offset.
MBA	I	Port-A mailbox select. A high level on MBA chooses a mailbox register for a port-A read or write operation. When the A0–A35 outputs are active, a high level on MBA selects data from the mail2 register for output and a low level selects FIFO2 output register data for output.
MBB	I	Port-B mailbox select. A high level on MBB chooses a mailbox register for a port-B read or write operation. When the B0–B35 outputs are active, a high level on MBB selects data from the mail1 register for output and a low level selects FIFO1 output register data for output.
MBF1	O	Mail1 register flag. $\overline{MBF1}$ is set low by the low-to-high transition of CLKA that writes data to the mail1 register. Writes to the mail1 register are inhibited while $\overline{MBF1}$ is low. $\overline{MBF1}$ is set high by a low-to-high transition of CLKB when a port-B read is selected and MBB is high. $\overline{MBF1}$ is set high when the device is reset.

Terminal Functions (Continued)

PIN NAME	I/O	DESCRIPTION
MBF2	O	Mail2 register flag. MBF2 is set low by the low-to-high transition of CLKB that writes data to the mail2 register. Writes to the mail2 register are inhibited while MBF2 is low. MBF2 is set high by a low-to-high transition of CLKA when a port-A read is selected and MBA is high. MBF2 is set high when the device is reset.
ODD/ EVEN	I	Odd/even parity select. Odd parity is checked on each port when ODD/ <u>EVEN</u> is high and even parity is checked when ODD/ <u>EVEN</u> is low. ODD/ <u>EVEN</u> also selects the type of parity generated for each port if parity generation is enabled for a read operation.
PEFA	O (port A)	Port-A parity error flag. When any byte applied to A0–A35 fails parity, <u>PEFA</u> is low. Bytes are organized as A0–A8, A9–A17, A18–A26, and A27–A35, with the most-significant bit of each byte serving as the parity bit. The type of parity checked is determined by the state of ODD/ <u>EVEN</u> . The parity trees used to check the A0–A35 inputs are shared by the mail2 register to generate parity if parity generation is selected by PGA. Therefore, if a mail2 read with parity generation is set up by having W/ <u>RA</u> low, MBA high, and PGA high, <u>PEFA</u> is forced high regardless of the state of the A0–A35 inputs.
PEFB	O (port B)	Port-B parity error flag. When any byte applied to terminals B0–B35 fails parity, <u>PEFB</u> is low. Bytes are organized as B0–B8, B9–B17, B18–B26, and B27–B35, with the most-significant bit of each byte serving as the parity bit. The type of parity checked is determined by the state of ODD/ <u>EVEN</u> . The parity trees used to check the B0–B35 inputs are shared by the mail1 register to generate parity if parity generation is selected by PGB. Therefore, if a mail1 read with parity generation is set up by having W/ <u>RB</u> low, MBB high, and PGB high, <u>PEFB</u> is forced high regardless of the state of the B0–B35 inputs.
PGA	I	Port-A parity generation. Parity is generated for data reads from port A when PGA is high. The type of parity generated is selected by the state of ODD/ <u>EVEN</u> . Bytes are organized as A0–A8, A9–A17, A18–A26, and A27–A35. The generated parity bits are output in the most-significant bit of each byte.
PGB	I	Port-B parity generation. Parity is generated for data reads from port B when PGB is high. The type of parity generated is selected by the state of ODD/ <u>EVEN</u> . Bytes are organized as B0–B8, B9–B17, B18–B26, and B27–B35. The generated parity bits are output in the most-significant bit of each byte.
RST	I	Reset. To reset the device, four low-to-high transitions of <u>CLKA</u> and four low-to-high transitions of <u>CLKB</u> must occur while RST is low. This sets AFA, AFB, MBF1, and MBF2 high and EFA, EFB, AEA, AEB, FFA, and FFB low. The low-to-high transition of <u>RST</u> latches the status of FS1 and FS0 to select almost-full flag and almost-empty flag offset.
W/ <u>RA</u>	I	Port-A write/read select. W/ <u>RA</u> high selects a write operation and a low selects a read operation on port A for a low-to-high transition of CLKA. The A0–A35 outputs are in the high-impedance state when W/ <u>RA</u> is high.
W/ <u>RB</u>	I	Port-B write/read select. W/ <u>RB</u> high selects a write operation and a low selects a read operation on port B for a low-to-high transition of CLKB. The B0–B35 outputs are in the high-impedance state when W/ <u>RB</u> is high.

detailed description

reset

The SN74ABT3612 is reset by taking the reset (RST) input low for at least four port-A clock (CLKA) and four port-B clock (CLKB) low-to-high transitions. RST can switch asynchronously to the clocks. A device reset initializes the internal read and write pointers of each FIFO and forces the full flags (FFA, FFB) low, the empty flags (EFA, EFB) low, the almost-empty flags (AEA, AEB) low, and the almost-full flags (AFA, AFB) high. A reset also forces the mailbox flags (MBF1, MBF2) high. After a reset, FFA is set high after two low-to-high transitions of CLKA and FFB is set high after two low-to-high transitions of CLKB. The device must be reset after power up before data is written to its memory.

A low-to-high transition on RST loads the almost-full and almost-empty offset register (X) with the value selected by the flag-select (FS0, FS1) inputs. The values that can be loaded into the register are shown in Table 1.

reset (continued)

Table 1. Flag Programming

FS1	FS0	RST	ALMOST-FULL AND ALMOST-EMPTY FLAG OFFSET REGISTER (X)
H	H	↑	16
H	L	↑	12
L	H	↑	8
L	L	↑	4

FIFO write/read operation

The state of the port-A data (A0–A35) outputs is controlled by the port-A chip select (\overline{CSA}) and the port-A write/read select (W/\overline{RA}). The A0–A35 outputs are in the high-impedance state when either \overline{CSA} or W/\overline{RA} is high. The A0–A35 outputs are active when both \overline{CSA} and W/\overline{RA} are low. Data is loaded into FIFO1 from the A0–A35 inputs on a low-to-high transition of CLKA when \overline{CSA} is low, W/\overline{RA} is high, ENA is high, MBA is low, and \overline{FFA} is high. Data is read from FIFO2 to the A0–A35 outputs by a low-to-high transition of CLKA when \overline{CSA} is low, W/\overline{RA} is low, ENA is high, MBA is low, and \overline{EFA} is high (see Table 2).

Table 2. Port-A Enable Function Table

CSA	W/\overline{RA}	ENA	MBA	CLKA	A0–A35 OUTPUTS	PORT FUNCTION
H	X	X	X	X	In high-impedance state	None
L	H	L	X	X	In high-impedance state	None
L	H	H	L	↑	In high-impedance state	FIFO1 write
L	H	H	H	↑	In high-impedance state	Mail1 write
L	L	L	L	X	Active, FIFO2 output register	None
L	L	H	L	↑	Active, FIFO2 output register	FIFO2 read
L	L	L	H	X	Active, mail2 register	None
L	L	H	H	↑	Active, mail2 register	Mail2 read (set $\overline{MBF2}$ high)

The port-B control signals are identical to those of port A. The state of the port-B data (B0–B35) outputs is controlled by the port-B chip select (\overline{CSB}) and the port-B write/read select (W/\overline{RB}). The B0–B35 outputs are in the high-impedance state when either \overline{CSB} or W/\overline{RB} is high. The B0–B35 outputs are active when both \overline{CSB} and W/\overline{RB} are low.

Data is loaded into FIFO2 from the B0–B35 inputs on a low-to-high transition of CLKB when \overline{CSB} is low, W/\overline{RB} is high, ENB is high, MBB is low, and \overline{FFB} is high. Data is read from FIFO1 to the B0–B35 outputs by a low-to-high transition of CLKB when \overline{CSB} is low, W/\overline{RB} is low, ENB is high, MBB is high, and \overline{EFB} is high (see Table 3).

The setup- and hold-time constraints to the port clocks for the port-chip selects (\overline{CSA} , \overline{CSB}) and write/read selects (W/\overline{RA} , W/\overline{RB}) are only for enabling write and read operations and are not related to high-impedance control of the data outputs. If a port enable is low during a clock cycle, the port-chip select and write/read select can change states during the setup- and hold-time window of the cycle.

FIFO write/read operation (continued)

Table 3. Port-B Enable Function Table

CSB	W/RB	ENB	MBB	CLKB	B0–B35 OUTPUTS	PORT FUNCTION
H	X	X	X	X	In high-impedance state	None
L	H	L	X	X	In high-impedance state	None
L	H	H	L	↑	In high-impedance state	FIFO2 write
L	H	H	H	↑	In high-impedance state	Mail2 write
L	L	L	L	X	Active, FIFO1 output register	None
L	L	H	L	↑	Active, FIFO1 output register	FIFO1 read
L	L	L	H	X	Active, mail1 register	None
L	L	H	H	↑	Active, mail1 register	Mail1 read (set $\overline{\text{MBF1}}$ high)

synchronized FIFO flags

Each FIFO flag is synchronized to its port clock through two flip-flop stages. This is done to improve flag reliability by reducing the probability of metastable events on the output when CLKA and CLKB operate asynchronously to one another. $\overline{\text{EFA}}$, $\overline{\text{AEA}}$, $\overline{\text{FFA}}$, and $\overline{\text{AFA}}$ are synchronized to CLKA . $\overline{\text{EFB}}$, $\overline{\text{AEB}}$, $\overline{\text{FFB}}$, and $\overline{\text{AFB}}$ are synchronized to CLKB . Tables 4 and 5 show the relationship of each port flag to FIFO1 and FIFO2.

Table 4. FIFO1 Flag Operation

NUMBER OF WORDS IN FIFO1†	SYNCHRONIZED TO CLKB		SYNCHRONIZED TO CLKA	
	EFB	AEB	AFA	FFA
0	L	L	H	H
1 to X	H	L	H	H
(X + 1) to [64 – (X + 1)]	H	H	H	H
(64 – X) to 63	H	H	L	H
64	H	H	L	L

† X is the value in the almost-empty flag and almost-full flag offset register.

Table 5. FIFO2 Flag Operation

NUMBER OF WORDS IN FIFO2†	SYNCHRONIZED TO CLKA		SYNCHRONIZED TO CLKB	
	EFA	AEA	AFB	FFB
0	L	L	H	H
1 to X	H	L	H	H
(X + 1) to [64 – (X + 1)]	H	H	H	H
(64 – X) to 63	H	H	L	H
64	H	H	L	L

† X is the value in the almost-empty flag and almost-full flag offset register.

empty flags (\overline{EFA} , \overline{EFB})

The empty flag of a FIFO is synchronized to the port clock that reads data from its array. When the empty flag is high, new data can be read to the FIFO output register. When the empty flag is low, the FIFO is empty and attempted FIFO reads are ignored.

The read pointer of a FIFO is incremented each time a new word is clocked to the output register. A word written to a FIFO can be read to the FIFO output register in a minimum of three cycles of the empty flag synchronizing clock; therefore, an empty flag is low if a word in memory is the next data to be sent to the FIFO output register and two cycles of the port clock that reads data from the FIFO have not elapsed since the time the word was written. The empty flag of the FIFO is set high by the second low-to-high transition of the synchronizing clock and the new data word can be read to the FIFO output register in the following cycle.

A low-to-high transition on an empty flag synchronizing clock begins the first synchronization cycle of a write if the clock transition occurs at time t_{sk1} , or greater, after the write. Otherwise, the subsequent clock cycle can be the first synchronization cycle (see Figures 6 and 7).

full flags (\overline{FFA} , \overline{FFB})

The full flag of a FIFO is synchronized to the port clock that writes data to its array. When the full flag is high, a memory location is free in the SRAM to receive new data. No memory locations are free when the full flag is low and attempted writes to the FIFO are ignored.

Each time a word is written to a FIFO, the write pointer is incremented. From the time a word is read from a FIFO, the previous memory location is ready to be written in a minimum of three cycles of the full flag synchronizing clock; therefore, a full flag is low if less than two cycles of the full-flag synchronizing clock have elapsed since the next memory write location has been read. The second low-to-high transition on the full-flag synchronizing clock after the read sets the full flag high and data can be written in the following clock cycle.

A low-to-high transition on a full-flag synchronizing clock begins the first synchronization cycle of a read if the clock transition occurs at time t_{sk1} , or greater, after the read. Otherwise, the subsequent clock cycle can be the first synchronization cycle (see Figures 8 and 9).

almost-empty flags (\overline{AEA} , \overline{AEB})

The almost-empty flag of a FIFO is synchronized to the port clock that reads data from its array. The almost-empty state is defined by the value of the almost-full and almost-empty offset register (X). This register is loaded with one of four preset values during a device reset (see *reset*). An almost-empty flag is low when the FIFO contains X or less words in memory and is high when the FIFO contains (X + 1) or more words.

Two low-to-high transitions of the almost-empty flag synchronizing clock are required after a FIFO write for the almost-empty flag to reflect the new level of fill; therefore, the almost-empty flag of a FIFO containing (X + 1) or more words remains low if two cycles of the synchronizing clock have not elapsed since the write that filled the memory to the (X + 1) level. An almost-empty flag is set high by the second low-to-high transition of the synchronizing clock after the FIFO write that fills memory to the (X + 1) level. A low-to-high transition of an almost-empty flag synchronizing clock begins the first synchronization cycle if it occurs at time t_{sk2} , or greater, after the write that fills the FIFO to (X + 1) words. Otherwise, the subsequent synchronizing clock cycle can be the first synchronization cycle (see Figures 11 and 12).

almost-full flags (\overline{AFA} , \overline{AFB})

The almost-full flag of a FIFO is synchronized to the port clock that writes data to its array. The almost-full state is defined by the value of the almost-full and almost-empty offset register (X). This register is loaded with one of four preset values during a device reset (see *reset*). An almost-full flag is low when the FIFO contains (64 – X) or more words in memory and is high when the FIFO contains [64 – (X + 1)] or less words.

Two low-to-high transitions of the almost-full flag synchronizing clock are required after a FIFO read for the almost-full flag to reflect the new level of fill; therefore, the almost-full flag of a FIFO containing [64 – (X + 1)] or less words remains low if two cycles of the synchronizing clock have not elapsed since the read that reduced the number of words in memory to [64 – (X + 1)]. An almost-full flag is set high by the second low-to-high

almost-full flags (\overline{AFA} , \overline{AFB}) (continued)

transition of the synchronizing clock after the FIFO read that reduces the number of words in memory to $[64 - (X + 1)]$. A low-to-high transition of an almost-full flag synchronizing clock begins the first synchronization cycle if it occurs at time t_{sk2} , or greater, after the read that reduces the number of words in memory to $[64 - (X + 1)]$. Otherwise, the subsequent synchronizing clock cycle can be the first synchronization cycle (see Figures 13 and 14).

mailbox registers

Each FIFO has a 36-bit bypass register to pass command and control information between port A and port B without putting it in queue. The mailbox-select (MBA, MBB) inputs choose between a mail register and a FIFO for a port-data-transfer operation. A low-to-high transition on CLKA writes A0–A35 data to the mail1 register when a port-A write is selected by \overline{CSA} , W/\overline{RA} , and ENA and MBA is high. A low-to-high transition on CLKB writes B0–B35 data to the mail2 register when a port-B write is selected by \overline{CSB} , W/\overline{RB} , and ENB and MBB is high. Writing data to a mail register sets the corresponding flag ($\overline{MBF1}$ or $\overline{MBF2}$) low. Attempted writes to a mail register are ignored while the mail flag is low.

When a port's data outputs are active, the data on the bus comes from the FIFO output register when the port mailbox-select input (MBA, MBB) is low and from the mail register when MBA/MBB is high. The mail1 register flag ($\overline{MBF1}$) is set high by a low-to-high transition on CLKB when a port-B read is selected by \overline{CSB} , W/\overline{RB} , and ENB and MBB is high. The mail2 register flag ($\overline{MBF2}$) is set high by a low-to-high transition on CLKA when a port-A read is selected by \overline{CSA} , W/\overline{RA} , and ENA and MBA is high. The data in a mail register remains intact after it is read and changes only when new data is written to the register.

parity checking

The port-A inputs (A0–A35) and port-B inputs (B0–B35) each have four parity trees to check the parity of incoming (or outgoing) data. A parity failure on one or more bytes of the input bus is reported by a low level on the port-parity-error flag (\overline{PEFA} , \overline{PEFB}). Odd- or even-parity checking can be selected and the parity-error flags can be ignored if this feature is not desired.

Parity status is checked on each input bus according to the level of the odd/even parity (ODD/\overline{EVEN}) select input. A parity error on one or more bytes of a port is reported by a low level on the corresponding \overline{PEFA} , \overline{PEFB} . Port-A bytes are arranged as A0–A8, A9–A17, A18–A26, and A27–A35, with the most-significant bit of each byte used as the parity bit. Port-B bytes are arranged as B0–B8, B9–B17, B18–B26, and B27–B35, with the most-significant bit of each byte used as the parity bit. When odd/even parity is selected, \overline{PEFA} , \overline{PEFB} is low if any byte on the port has an odd/even number of low levels applied to the bits.

The four parity trees used to check the A0–A35 inputs are shared by the mail2 register when parity generation is selected for port-A reads (PGA = high). When a port-A read from the mail2 register with parity generation is selected with W/\overline{RA} low, \overline{CSA} low, ENA high, MBA high, and PGA high, \overline{PEFA} is held high, regardless of the levels applied to the A0–A35 inputs. Likewise, the parity trees used to check the B0–B35 inputs are shared by the mail1 register when parity generation is selected for port-B reads (PGB = high). When a port-B read from the mail1 register with parity generation is selected with W/\overline{RB} low, \overline{CSB} low, ENB high, MBB high, and PGB high, \overline{PEFB} is held high, regardless of the levels applied to the B0–B35 inputs.

parity generation

A high level on the port-A parity-generate select (PGA) or port-B parity-generate select (PGB) enables the SN74ABT3612 to generate parity bits for port reads from a FIFO or mailbox register. Port-A bytes are arranged as A0–A8, A9–A17, A18–A26, and A27–A35, with the most-significant bit of each byte used as the parity bit. Port-B bytes are arranged as B0–B8, B9–B17, B18–B26, and B27–B35, with the most-significant bit of each byte used as the parity bit. A write to a FIFO or mail register stores the levels applied to all 36 inputs, regardless of the state of the parity-generate select (PGA, PGB) inputs. When data is read from a port with parity generation selected, the lower eight bits of each byte are used to generate a parity bit according to the level on the ODD/\overline{EVEN} select. The generated parity bits are substituted for the levels originally written to the most-significant bits of each byte as the word is read to the data outputs.

parity generation (continued)

Parity bits for FIFO data are generated after the data is read from SRAM and before the data is written to the output register. Therefore, the port-A parity generate select (PGA) and odd/even parity select (ODD/EVEN) have setup- and hold-time constraints to the port-A clock (CLKA) and the port-B parity generate select (PGB) and ODD/EVEN have setup- and hold-time constraints to the port-B clock (CLKB). These timing constraints apply only for a rising clock edge used to read a new word to the FIFO output register.

The circuit used to generate parity for the mail1 data is shared by the port-B bus (B0–B35) to check parity and the circuit used to generate parity for the mail2 data is shared by the port-A bus (A0–A35) to check parity. The shared parity trees of a port are used to generate parity bits for the data in a mail register when $\overline{W/RA}$, $\overline{W/RB}$ is low; MBA, MBB is high; \overline{CSA} , \overline{CSB} is low; ENA, ENB is high; and PGA, PGB is high. Generating parity for mail-register data does not change the contents of the register.

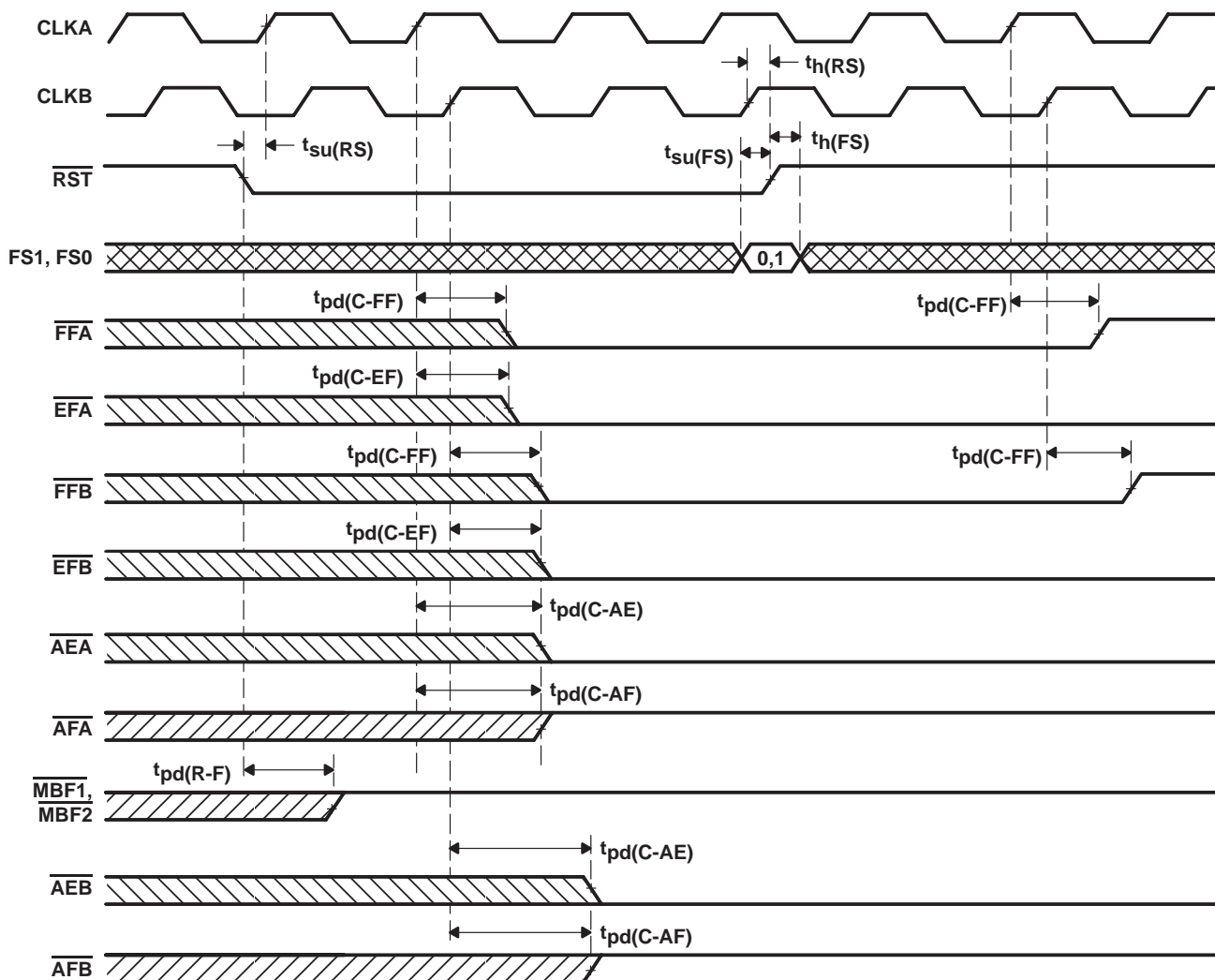
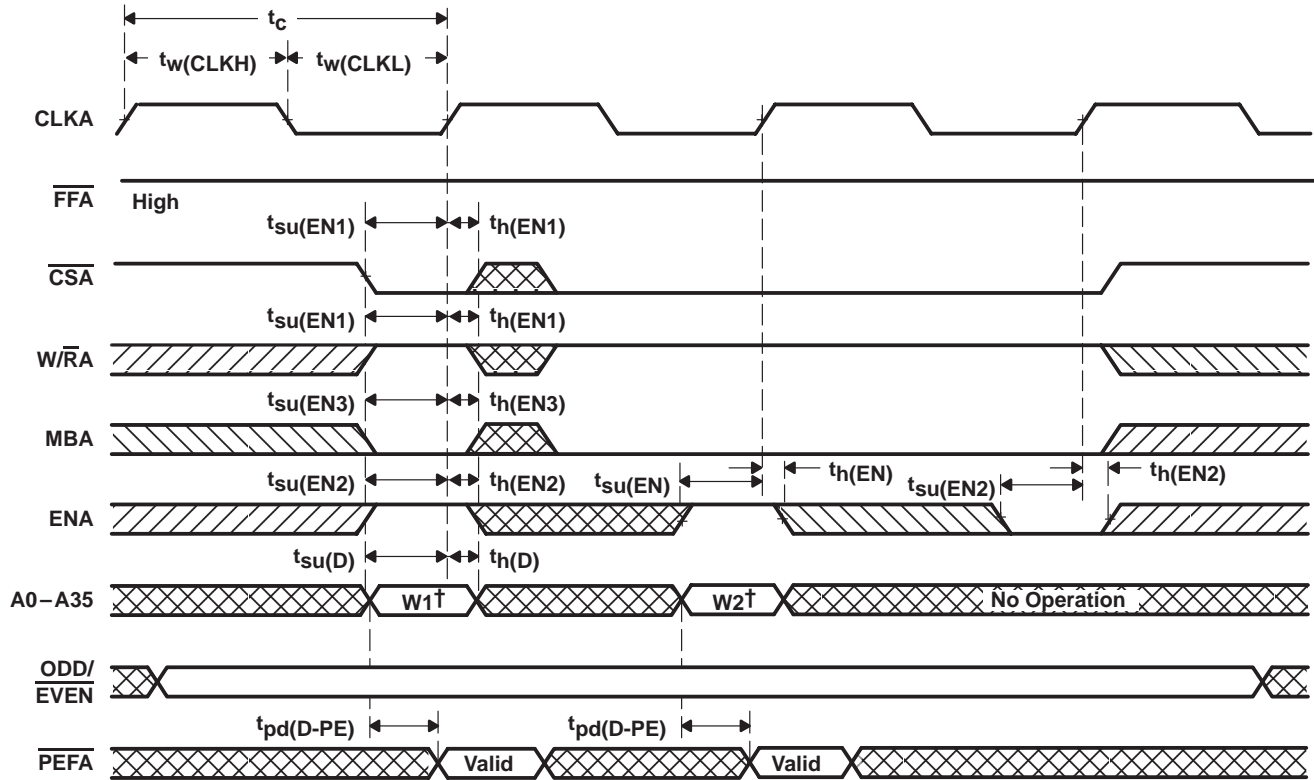

Figure 1. Device Reset Loading the X Register With the Value of Eight



† Written to FIFO1

Figure 2. Port-A Write-Cycle Timing for FIFO1

CLOCKED BIDIRECTIONAL FIRST-IN, FIRST-OUT MEMORY

SCBS129G – JULY 1992 – REVISED APRIL 1998

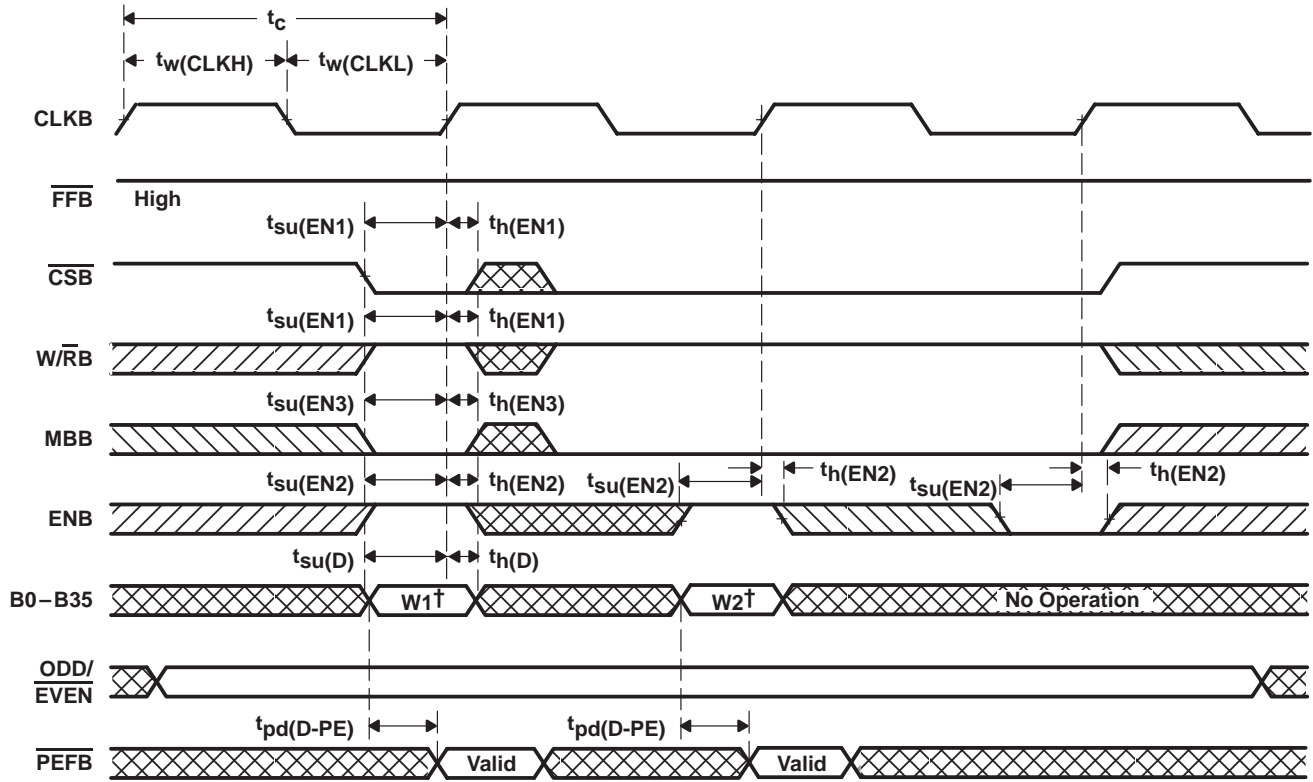

† Written to FIFO2

Figure 3. Port-B Write-Cycle Timing for FIFO2

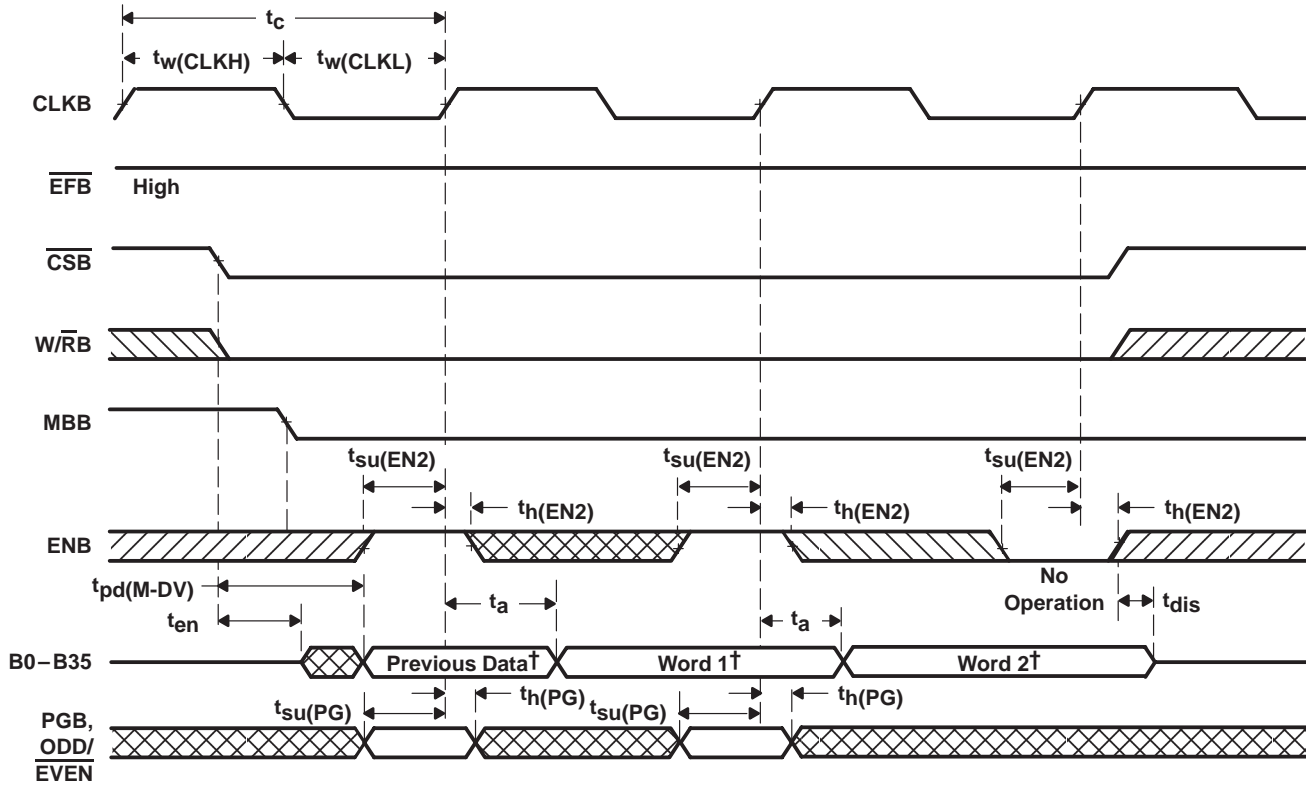

† Read from FIFO1

Figure 4. Port-B Read-Cycle Timing for FIFO1

CLOCKED BIDIRECTIONAL FIRST-IN, FIRST-OUT MEMORY

SCBS129G – JULY 1992 – REVISED APRIL 1998

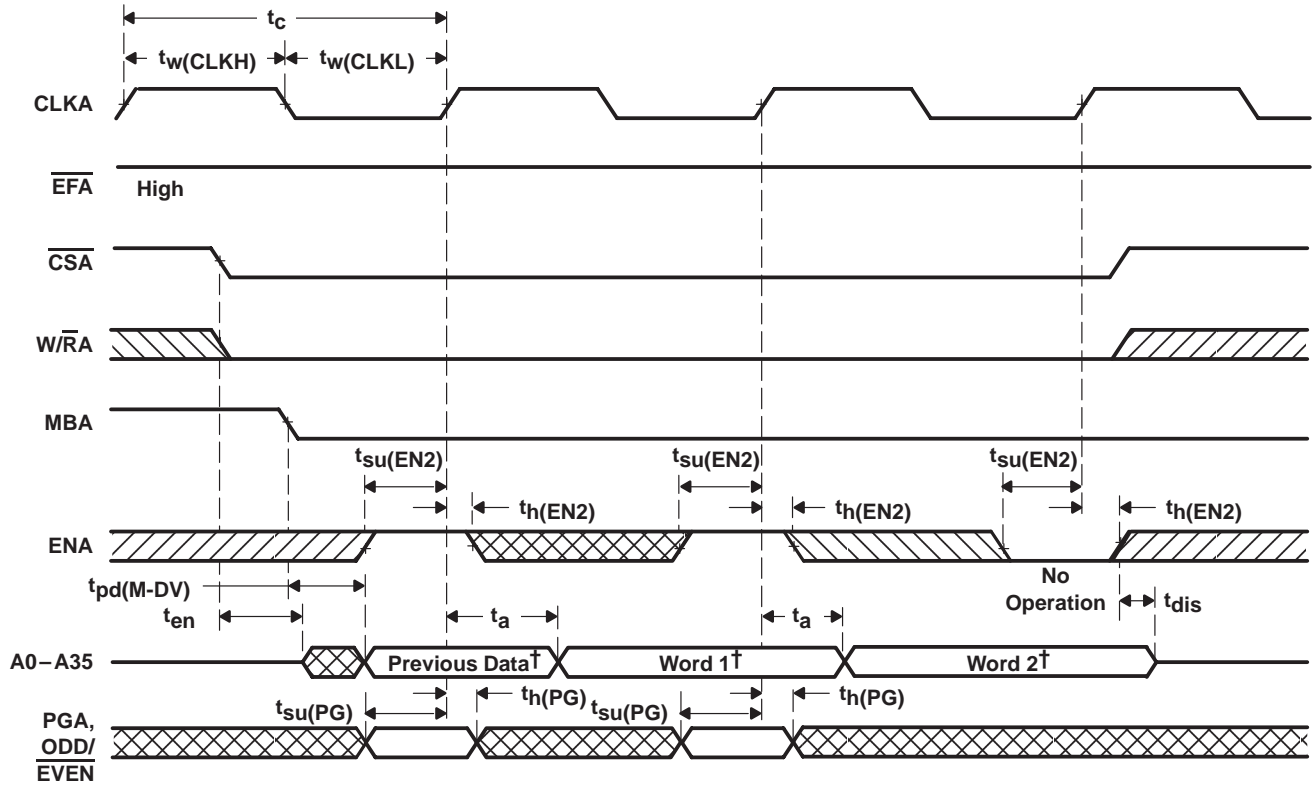

† Read from FIFO2

Figure 5. Port-A Read-Cycle Timing for FIFO2

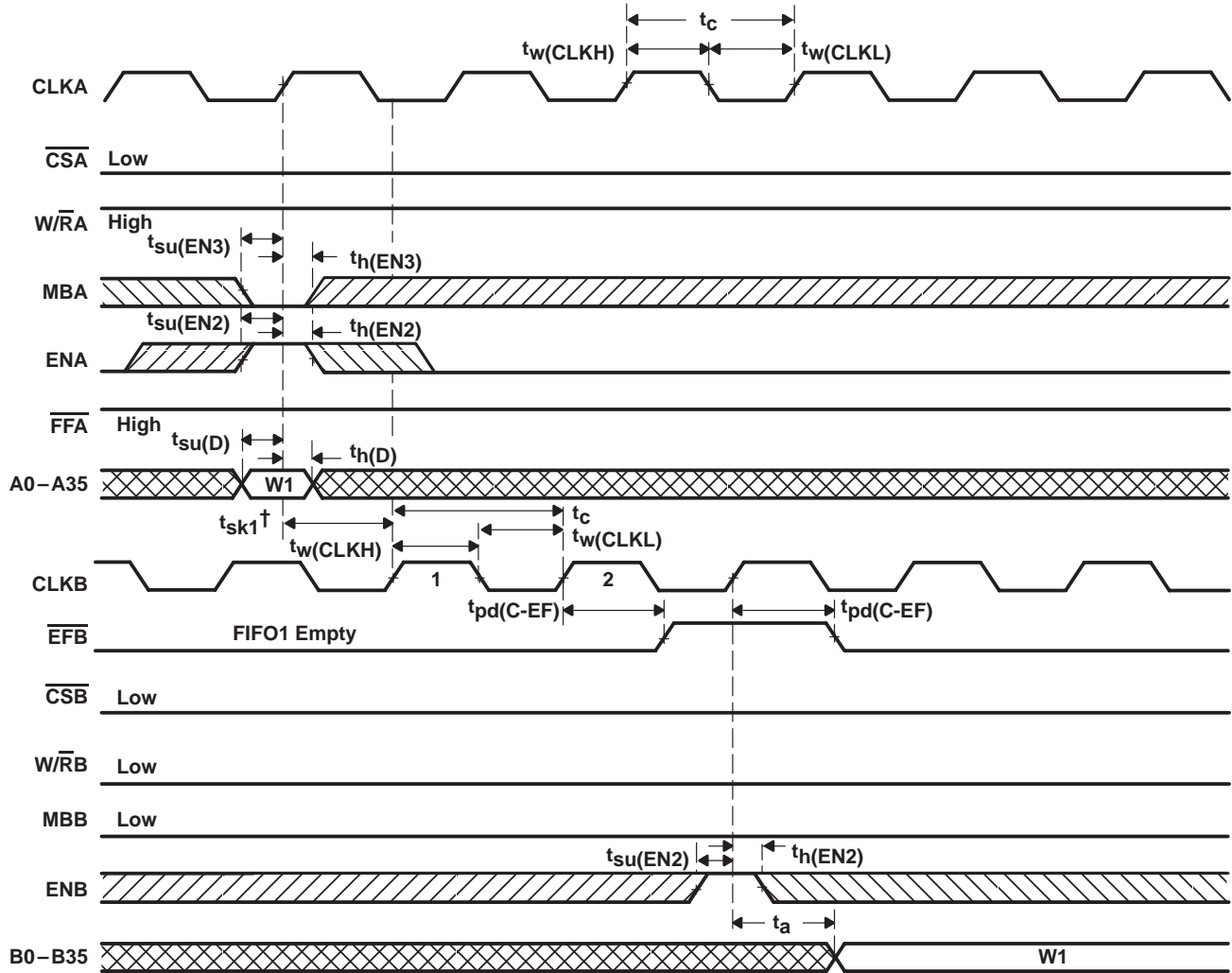

[†] t_{sk1} is the minimum time between a rising CLKA edge and a rising CLKB edge for $\overline{\text{EFB}}$ to transition high in the next CLKB cycle. If the time between the rising CLKA edge and rising CLKB edge is less than t_{sk1} , the transition of $\overline{\text{EFB}}$ high may occur one CLKB cycle later than shown.

Figure 6. $\overline{\text{EFB}}$ -Flag Timing and First Data Read When FIFO1 Is Empty

CLOCKED BIDIRECTIONAL FIRST-IN, FIRST-OUT MEMORY

SCBS129G – JULY 1992 – REVISED APRIL 1998

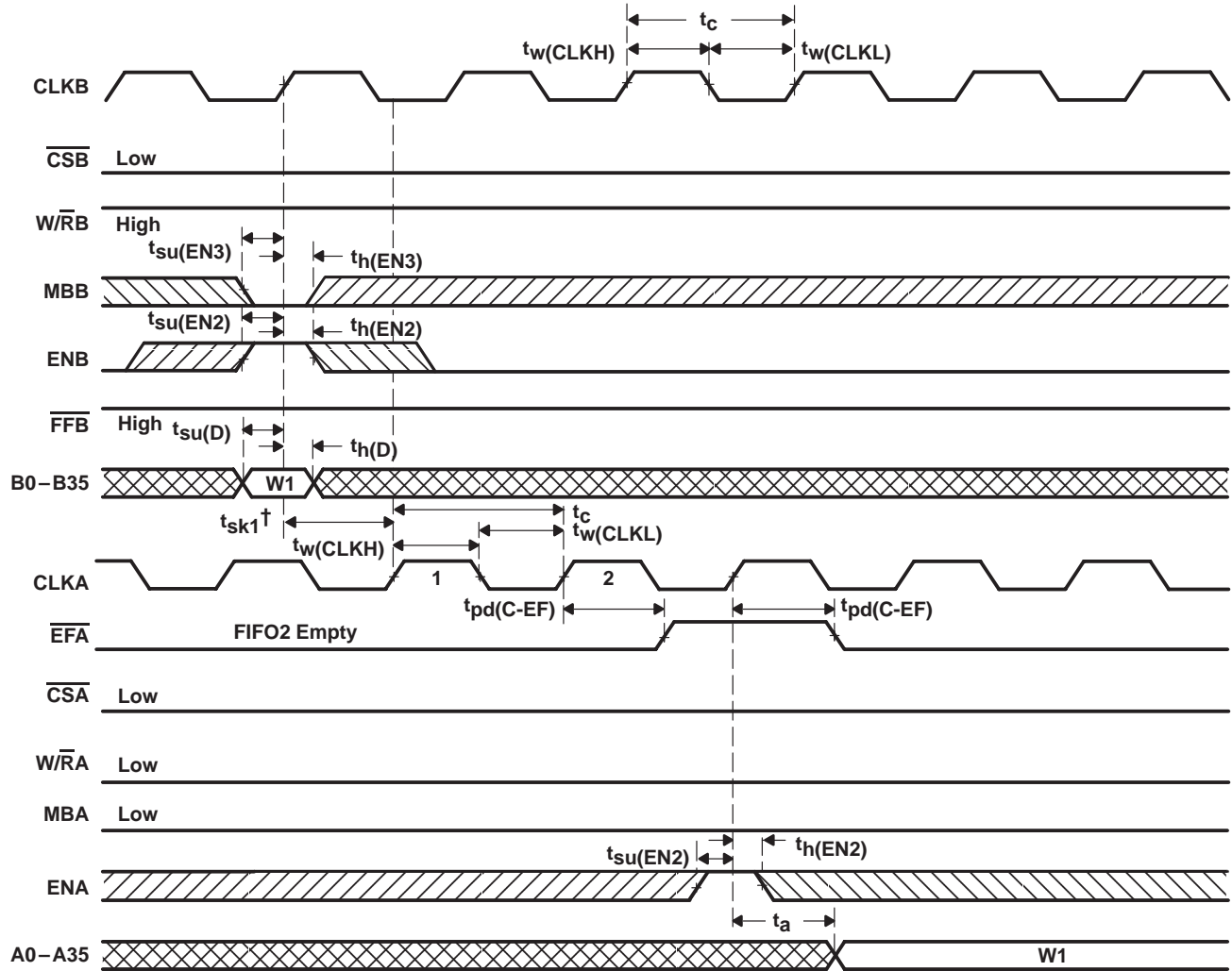

t_{sk1} is the minimum time between a rising CLKB edge and a rising CLKA edge for \overline{EFA} to transition high in the next CLKA cycle. If the time between the rising CLKB edge and rising CLKA edge is less than t_{sk1} , the transition of \overline{EFA} high may occur one CLKA cycle later than shown.

Figure 7. \overline{EFA} -Flag Timing and First Data Read When FIFO2 Is Empty

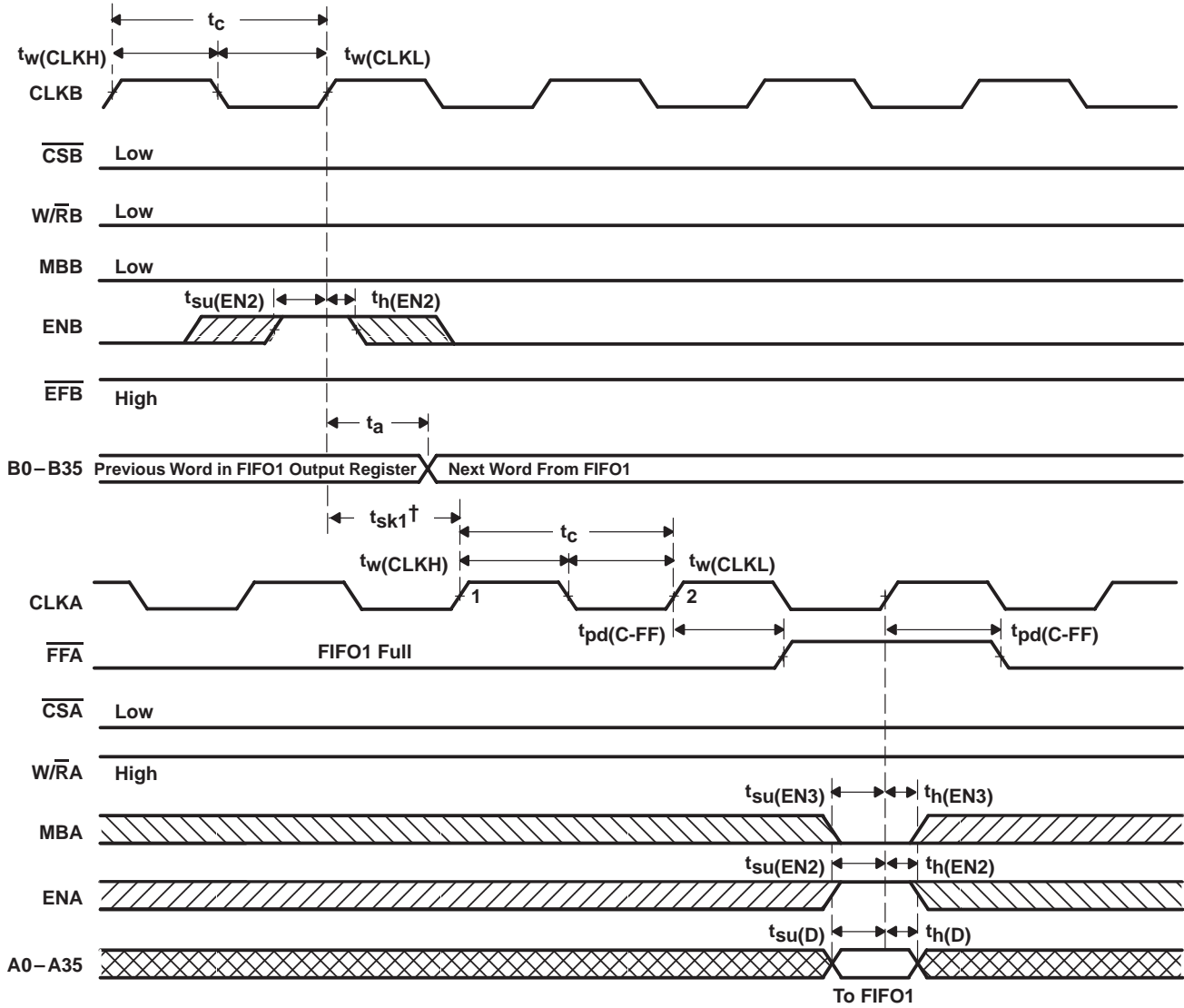

t_{sk1} is the minimum time between a rising CLKB edge and a rising CLKA edge for $\overline{\text{FFA}}$ to transition high in the next CLKA cycle. If the time between the rising CLKB edge and rising CLKA edge is less than t_{sk1} , $\overline{\text{FFA}}$ may transition high one CLKA cycle later than shown.

Figure 8. $\overline{\text{FFA}}$ -Flag Timing and First Available Write When FIFO1 Is Full

CLOCKED BIDIRECTIONAL FIRST-IN, FIRST-OUT MEMORY

SCBS129G – JULY 1992 – REVISED APRIL 1998

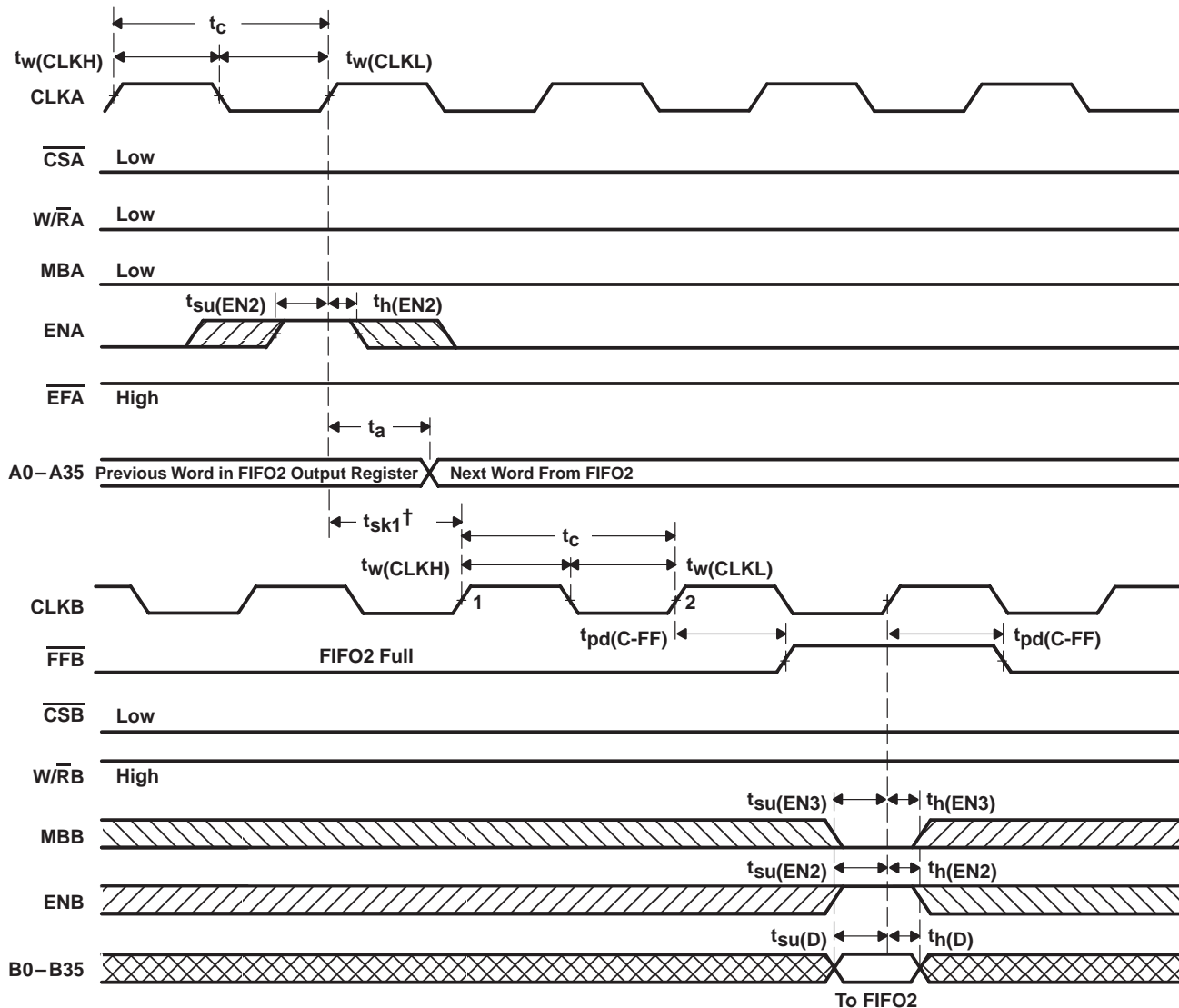

$^\dagger t_{sk1}$ is the minimum time between a rising CLKA edge and a rising CLKB edge for $\overline{\text{FFB}}$ to transition high in the next CLKB cycle. If the time between the rising CLKA edge and rising CLKB edge is less than t_{sk1} , $\overline{\text{FFB}}$ may transition high one CLKB cycle later than shown.

Figure 9. $\overline{\text{FFB}}$ -Flag Timing and First Available Write When FIFO2 Is Full

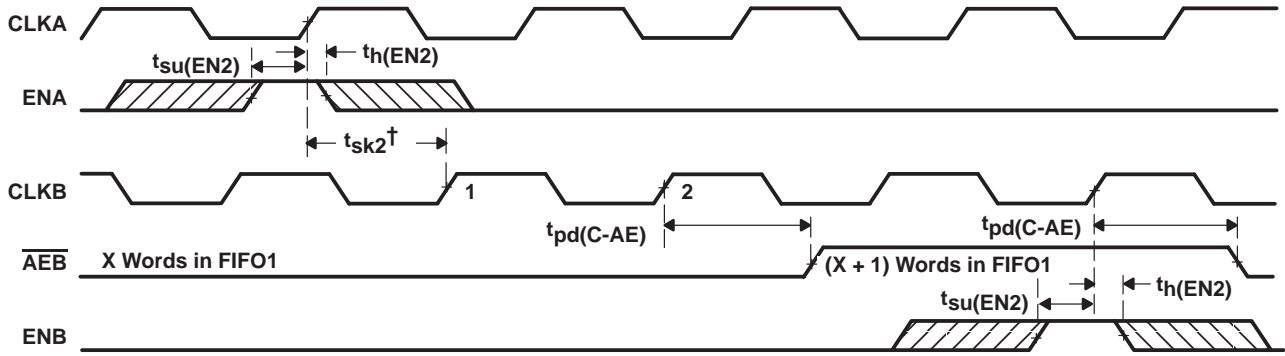

$^\dagger t_{sk2}$ is the minimum time between a rising CLKA edge and a rising CLKB edge for \overline{AEB} to transition high in the next CLKB cycle. If the time between the rising CLKA edge and rising CLKB edge is less than t_{sk2} , \overline{AEB} may transition high one CLKB cycle later than shown.
 NOTE A: FIFO1 write ($\overline{CSA} = L, W/\overline{RA} = H, MBA = L$), FIFO1 read ($\overline{CSB} = L, W/\overline{RB} = L, MBB = L$).

Figure 10. Timing for \overline{AEB} When FIFO1 Is Almost Empty

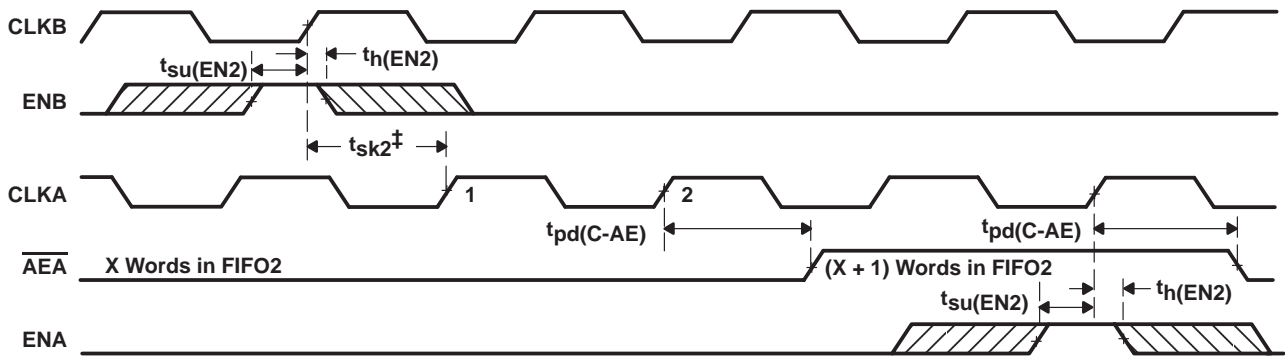

$^\ddagger t_{sk2}$ is the minimum time between a rising CLKB edge and a rising CLKA edge for \overline{AEA} to transition high in the next CLKA cycle. If the time between the rising CLKB edge and rising CLKA edge is less than t_{sk2} , \overline{AEA} may transition high one CLKA cycle later than shown.
 NOTE A: FIFO2 write ($\overline{CSB} = L, W/\overline{RB} = H, MBB = L$), FIFO2 read ($\overline{CSA} = L, W/\overline{RA} = L, MBA = L$).

Figure 11. Timing for \overline{AEA} When FIFO2 Is Almost Empty

CLOCKED BIDIRECTIONAL FIRST-IN, FIRST-OUT MEMORY

SCBS129G – JULY 1992 – REVISED APRIL 1998

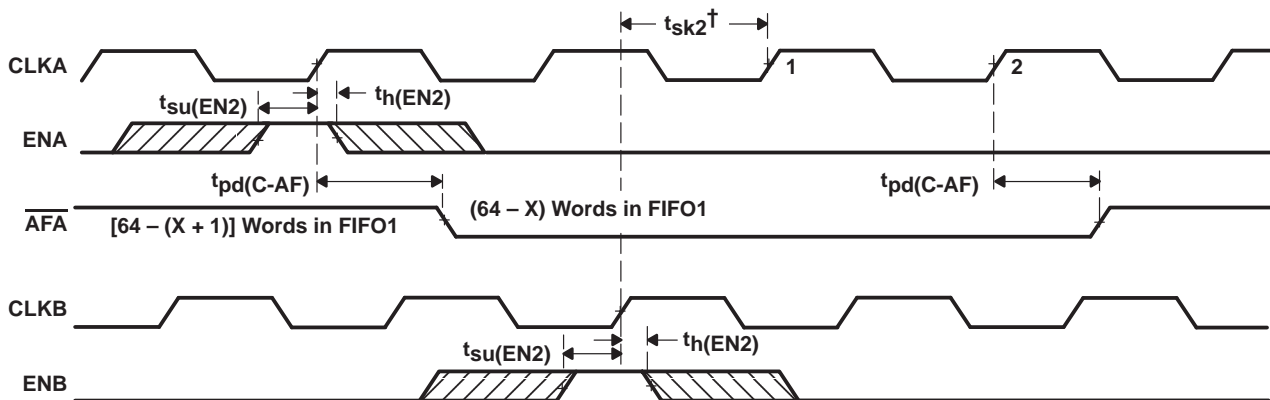

† t_{sk2} is the minimum time between a rising CLKA edge and a rising CLKB edge for \overline{AFA} to transition high in the next CLKA cycle. If the time between the rising CLKA edge and rising CLKB edge is less than t_{sk2} , \overline{AFA} may transition high one CLKB cycle later than shown.
 NOTE A: FIFO1 write ($\overline{CSA} = L, W/\overline{RA} = H, MBA = L$), FIFO1 read ($\overline{CSB} = L, W/\overline{RB} = L, MBB = L$).

Figure 12. Timing for \overline{AFA} When FIFO1 Is Almost Full

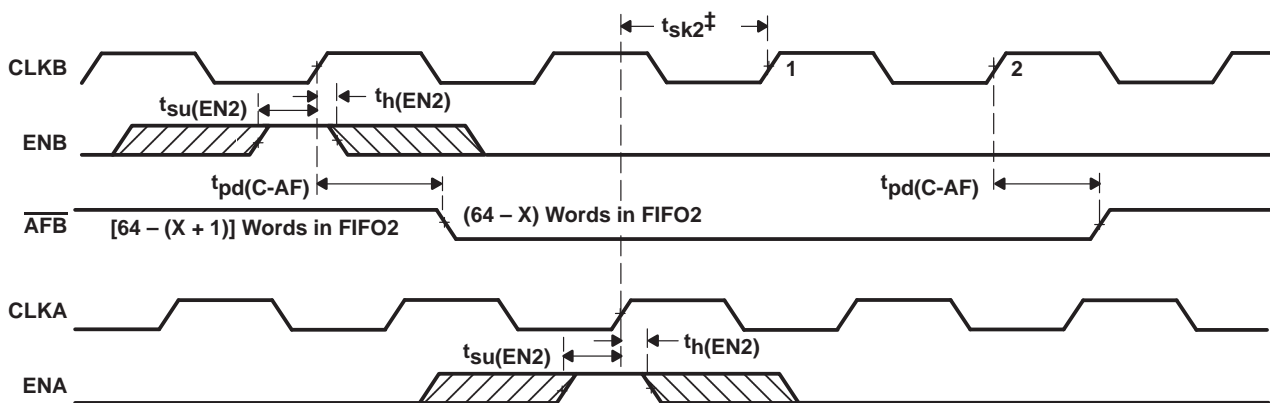

‡ t_{sk2} is the minimum time between a rising CLKB edge and a rising CLKA edge for \overline{AFB} to transition high in the next CLKB cycle. If the time between the rising CLKB edge and rising CLKA edge is less than t_{sk2} , \overline{AFB} may transition high one CLKA cycle later than shown.
 NOTE A: FIFO2 write ($\overline{CSB} = L, W/\overline{RB} = H, MBB = L$), FIFO2 read ($\overline{CSA} = L, W/\overline{RA} = L, MBA = L$).

Figure 13. Timing for \overline{AFB} When FIFO2 Is Almost Full

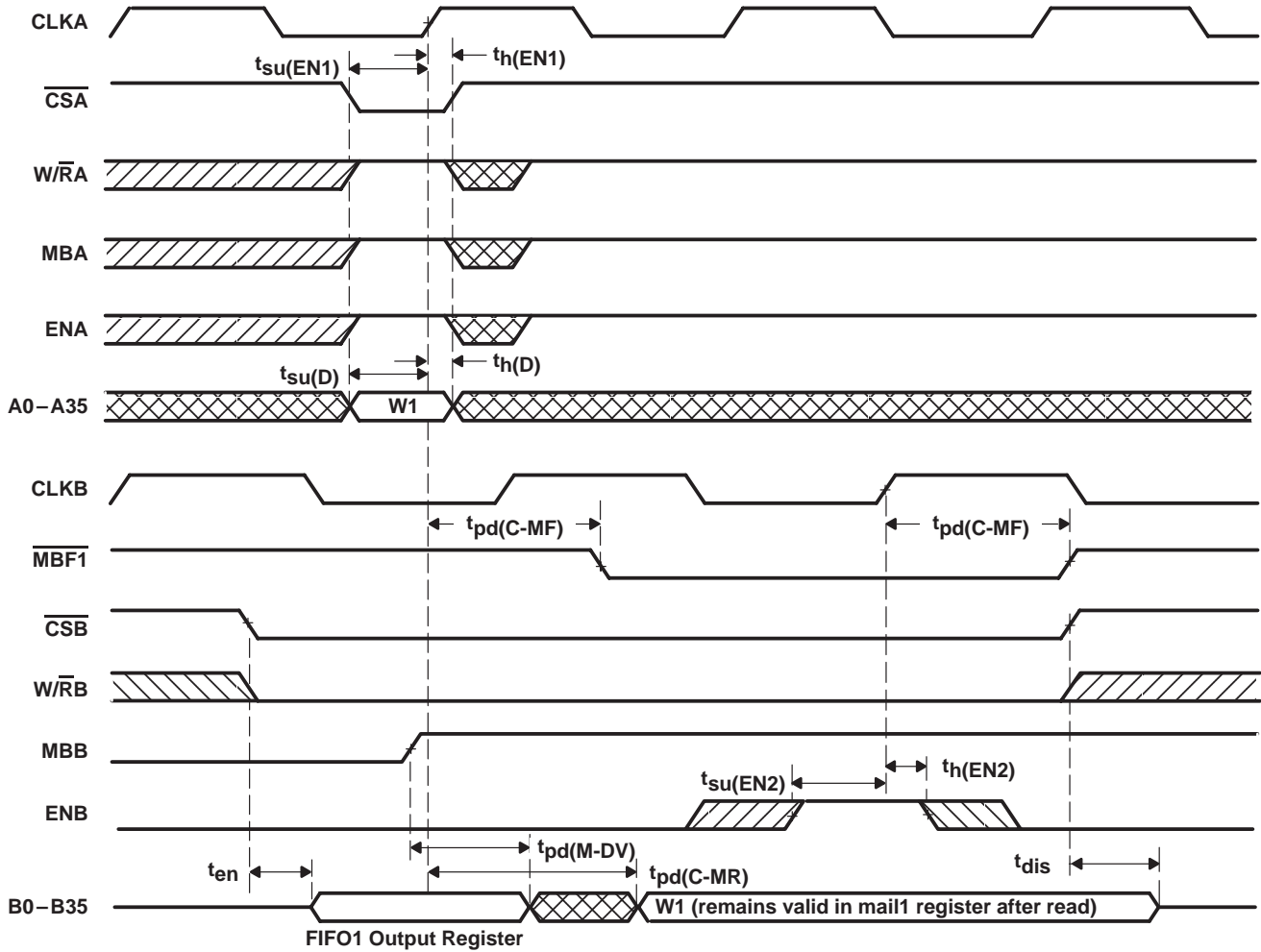

NOTE A: Port-B parity generation off (PGB = L)

Figure 14. Timing for Mail1 Register and $\overline{MBF1}$ Flag

CLOCKED BIDIRECTIONAL FIRST-IN, FIRST-OUT MEMORY

SCBS129G – JULY 1992 – REVISED APRIL 1998

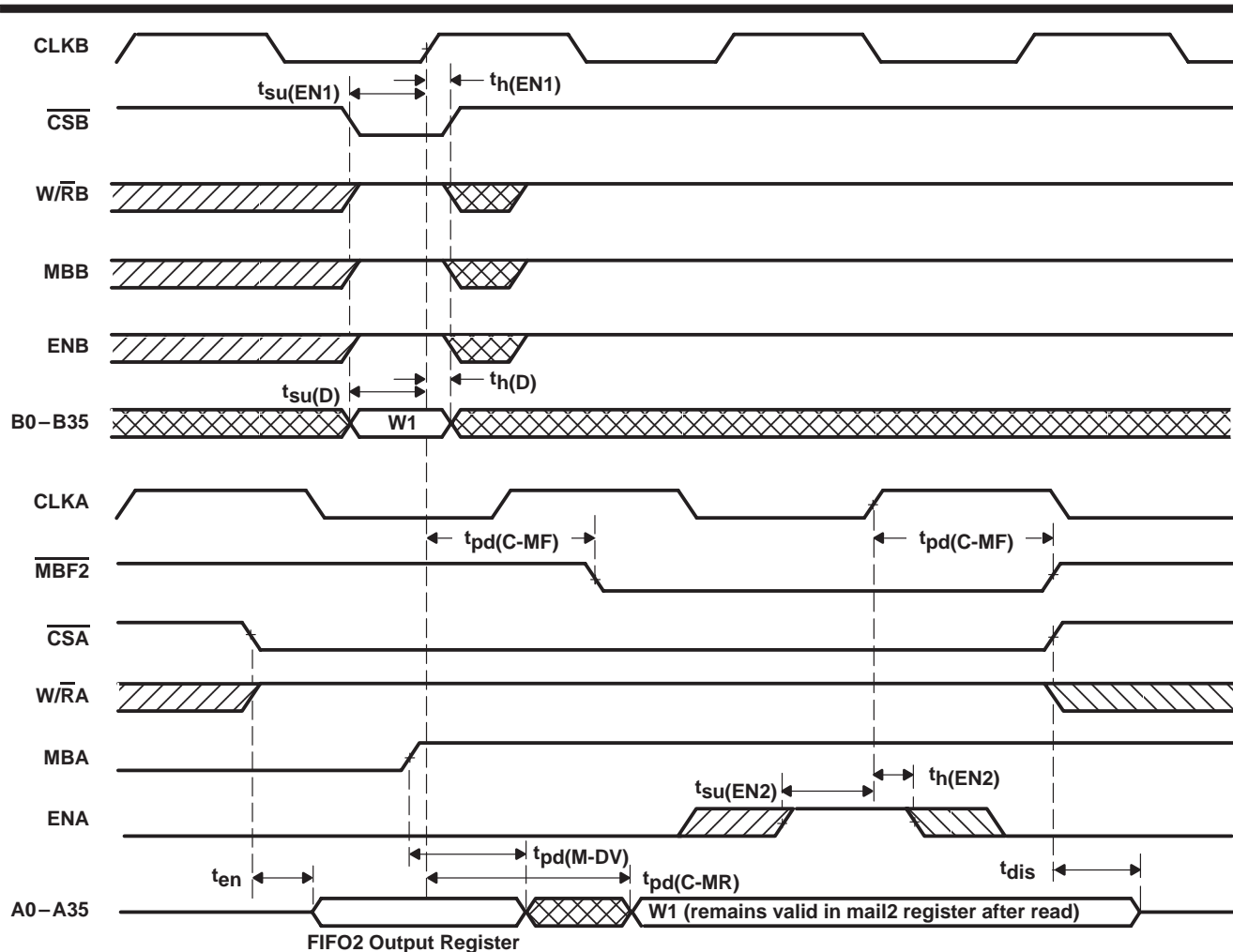

NOTE A: Port-A parity generation off (PGA = L)

Figure 15. Timing for Mail2 Register and $\overline{\text{MBF2}}$ Flag

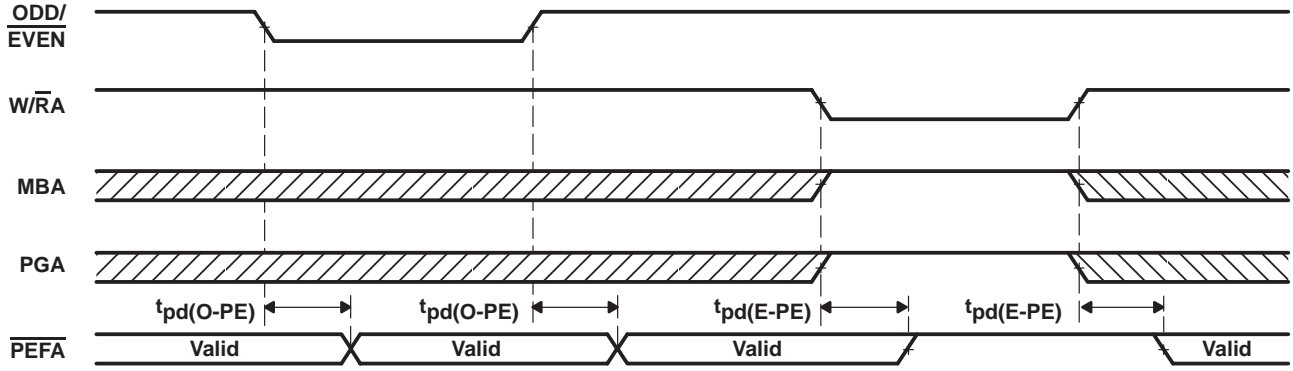

NOTE A: $\overline{\text{CSA}} = \text{L}$, $\text{ENA} = \text{H}$

Figure 16. ODD/ $\overline{\text{EVEN}}$, $\text{W}/\overline{\text{RA}}$, MBA , and PGA to $\overline{\text{PEFA}}$ Timing

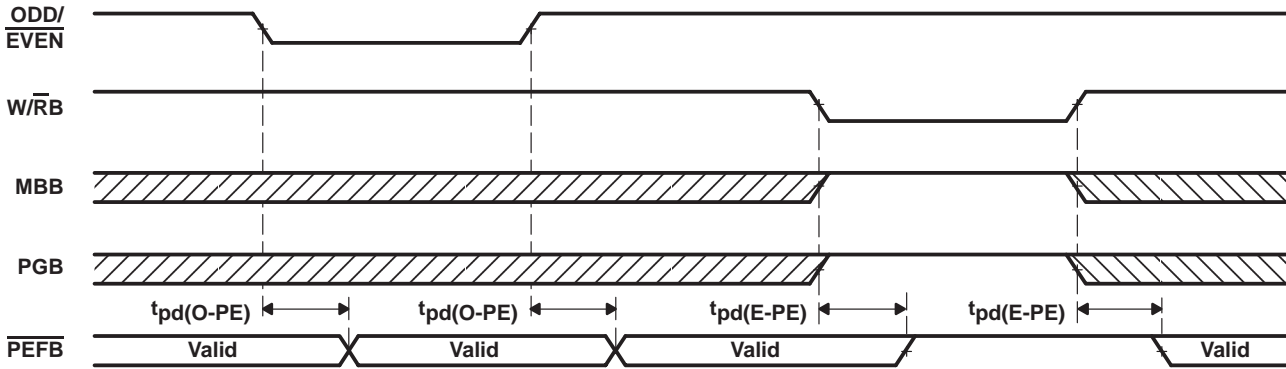

NOTE A: $\overline{\text{CSB}} = \text{L}$, $\text{ENB} = \text{H}$

Figure 17. ODD/ $\overline{\text{EVEN}}$, $\text{W}/\overline{\text{RB}}$, MBB , and PGB to $\overline{\text{PEFB}}$ Timing

CLOCKED BIDIRECTIONAL FIRST-IN, FIRST-OUT MEMORY

SCBS129G – JULY 1992 – REVISED APRIL 1998

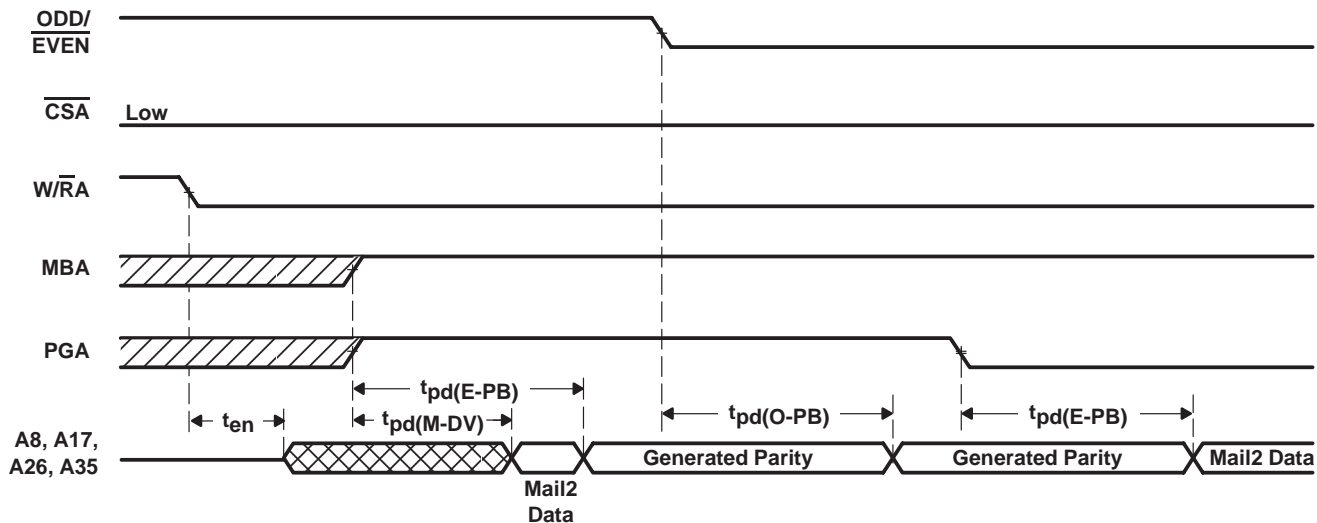

NOTE A: ENA = H

Figure 18. Parity-Generation Timing When Reading From the Mail2 Register

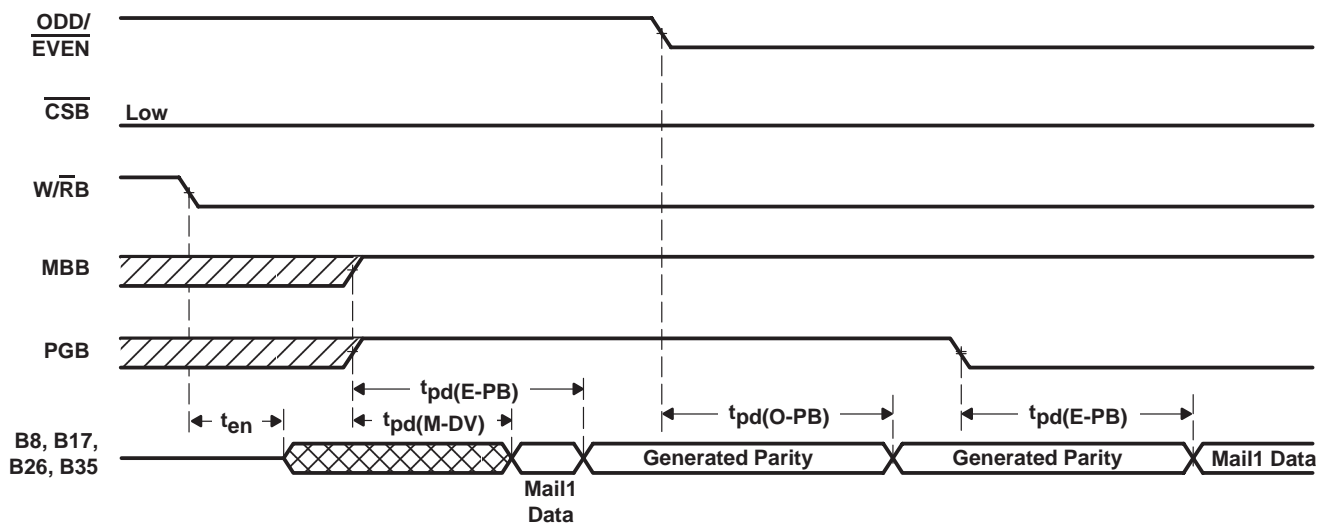

NOTE A: ENB = H

Figure 19. Parity-Generation Timing When Reading From the Mail1 Register

CLOCKED BIDIRECTIONAL FIRST-IN, FIRST-OUT MEMORY

absolute maximum ratings over operating free-air temperature range (unless otherwise noted)†

Supply voltage range, V_{CC}	-0.5 V to 7 V
Input voltage range, V_I (see Note 1)	-0.5 V to $V_{CC} + 0.5$ V
Output voltage range, V_O (see Note 1)	-0.5 V to $V_{CC} + 0.5$ V
Input clamp current, I_{IK} ($V_I < 0$ or $V_I > V_{CC}$)	±20 mA
Output clamp current, I_{OK} ($V_O < 0$ or $V_O > V_{CC}$)	±50 mA
Continuous output current, I_O ($V_O = 0$ to V_{CC})	±50 mA
Continuous current through V_{CC} or GND	±500 mA
Package thermal impedance, θ_{JA} (see Note 2): PCB package	28°C/W
PQ package	46°C/W
Storage temperature range, T_{stg}	-65°C to 150°C

† Stresses beyond those listed under “absolute maximum ratings” may cause permanent damage to the device. These are stress ratings only, and functional operation of the device at these or any other conditions beyond those indicated under “recommended operating conditions” is not implied. Exposure to absolute-maximum-rated conditions for extended periods may affect device reliability.

- NOTES: 1. The input and output voltage ratings may be exceeded provided the input and output current ratings are observed.
 2. The package thermal impedance is calculated in accordance with JESD 51.

recommended operating conditions

		MIN	MAX	UNIT
V_{CC}	Supply voltage	4.5	5.5	V
V_{IH}	High-level input voltage	2		V
V_{IL}	Low-level input voltage		0.8	V
I_{OH}	High-level output current		-4	mA
I_{OL}	Low-level output current		8	mA
T_A	Operating free-air temperature	0	70	°C

electrical characteristics over recommended operating free-air temperature range (unless otherwise noted)

PARAMETER	TEST CONDITIONS		MIN	TYP‡	MAX	UNIT
V_{OH}	$V_{CC} = 4.5$ V,	$I_{OH} = -4$ mA	2.4			V
V_{OL}	$V_{CC} = 4.5$ V,	$I_{OL} = 8$ mA			0.5	V
I_I	$V_{CC} = 5.5$ V,	$V_I = V_{CC}$ or 0			±50	µA
I_{OZ}	$V_{CC} = 5.5$ V,	$V_O = V_{CC}$ or 0			±50	µA
I_{CC}	$V_{CC} = 5.5$ V,	$I_O = 0$ mA,	$V_I = V_{CC}$ or GND	Outputs high	60	mA
				Outputs low	130	mA
				Outputs disabled	60	mA
C_i	$V_I = 0$,	$f = 1$ MHz		4		pF
C_o	$V_O = 0$,	$f = 1$ MHz		8		pF

‡ All typical values are at $V_{CC} = 5$ V, $T_A = 25^\circ\text{C}$.



CLOCKED BIDIRECTIONAL FIRST-IN, FIRST-OUT MEMORY

SCBS129G – JULY 1992 – REVISED APRIL 1998

timing requirements over recommended ranges of supply voltage and operating free-air temperature (see Figures 1 through 20)

		'ABT3612-15		'ABT3612-20		'ABT3612-30		UNIT
		MIN	MAX	MIN	MAX	MIN	MAX	
f_{clock}	Clock frequency, CLKA or CLKB	66.7		50		33.4		MHz
t_c	Clock cycle time, CLKA or CLKB	15		20		30		ns
$t_w(\text{CLKH})$	Pulse duration, CLKA and CLKB high	6		8		12		ns
$t_w(\text{CLKL})$	Pulse duration, CLKA and CLKB low	6		8		12		ns
$t_{\text{su}}(\text{D})$	Setup time, A0–A35 before CLKA↑ and B0–B35 before CLKB↑	4		5		6		ns
$t_{\text{su}}(\text{EN1})$	Setup time, $\overline{\text{CSA}}$, W/RA before CLKA↑; $\overline{\text{CSB}}$, W/RB before CLKB↑	6		6		7		ns
$t_{\text{su}}(\text{EN2})$	Setup time, ENA before CLKA↑; ENB before CLKB↑	4		5		6		ns
$t_{\text{su}}(\text{EN3})$	Setup time, MBA before CLKA↑; MBB before CLKB↑	4		5		6		ns
$t_{\text{su}}(\text{PG})$	Setup time, ODD/EVEN and PGA before CLKA↑; ODD/EVEN and PGB before CLKB↑†	4		5		6		ns
$t_{\text{su}}(\text{RS})$	Setup time, $\overline{\text{RST}}$ low before CLKA↑ or CLKB↑‡	5		6		7		ns
$t_{\text{su}}(\text{FS})$	Setup time, FS0 and FS1 before $\overline{\text{RST}}$ high	5		6		7		ns
$t_h(\text{D})$	Hold time, A0–A35 after CLKA↑ and B0–B35 after CLKB↑	2.5		2.5		2.5		ns
$t_h(\text{EN1})$	Hold time, $\overline{\text{CSA}}$, W/RA after CLKA↑; $\overline{\text{CSB}}$, W/RB after CLKB↑	2		2		2		ns
$t_h(\text{EN2})$	Hold time, ENA after CLKA↑; ENB after CLKB↑	2.5		2.5		2.5		ns
$t_h(\text{EN3})$	Hold time, MBA after CLKA↑; MBB after CLKB↑	1		1		1		ns
$t_h(\text{PG})$	Hold time, ODD/EVEN and PGA after CLKA↑; ODD/EVEN and PGB after CLKB↑†	1		1		1		ns
$t_h(\text{RS})$	Hold time, $\overline{\text{RST}}$ low after CLKA↑ or CLKB↑‡	5		6		7		ns
$t_h(\text{FS})$	Hold time, FS0 and FS1 after $\overline{\text{RST}}$ high	4		4		4		ns
$t_{\text{sk1}}§$	Skew time between CLKA↑ and CLKB↑ for $\overline{\text{EFA}}$, $\overline{\text{EFB}}$, $\overline{\text{FFA}}$, and $\overline{\text{FFB}}$	8		8		10		ns
$t_{\text{sk2}}§$	Skew time between CLKA↑ and CLKB↑ for $\overline{\text{AEA}}$, $\overline{\text{AEB}}$, $\overline{\text{AFA}}$, and $\overline{\text{AFB}}$	9		16		20		ns

† Only applies for a clock edge that does a FIFO read

‡ Requirement to count the clock edge as one of at least four needed to reset a FIFO

§ Skew time is not a timing constraint for proper device operation and is included only to illustrate the timing relationship between CLKA cycle and CLKB cycle.

switching characteristics over recommended ranges of supply voltage and operating free-air temperature, $C_L = 30$ pF (see Figures 1 through 20)

PARAMETER	'ABT3612-15		'ABT3612-20		'ABT3612-30		UNIT
	MIN	MAX	MIN	MAX	MIN	MAX	
f_{max}	66.7		50		33		MHz
t_a Access time, $CLKA\uparrow$ to A0–A35 and $CLKB\uparrow$ to B0–B35	2	10	2	12	2	15	ns
$t_{pd}(C-FF)$ Propagation delay time, $CLKA\uparrow$ to \overline{FFA} and $CLKB\uparrow$ to \overline{FFB}	2	10	2	12	2	15	ns
$t_{pd}(C-EF)$ Propagation delay time, $CLKA\uparrow$ to \overline{EFA} and $CLKB\uparrow$ to \overline{EFB}	2	10	2	12	2	15	ns
$t_{pd}(C-AE)$ Propagation delay time, $CLKA\uparrow$ to \overline{AEA} and $CLKB\uparrow$ to \overline{AEB}	2	10	2	12	2	15	ns
$t_{pd}(C-AF)$ Propagation delay time, $CLKA\uparrow$ to \overline{AFA} and $CLKB\uparrow$ to \overline{AFB}	2	10	2	12	2	15	ns
$t_{pd}(C-MF)$ Propagation delay time, $CLKA\uparrow$ to $\overline{MBF1}$ low or $\overline{MBF2}$ high and $CLKB\uparrow$ to $\overline{MBF2}$ low or $\overline{MBF1}$ high	1	9	1	12	1	15	ns
$t_{pd}(C-MR)$ Propagation delay time, $CLKA\uparrow$ to B0–B35 [†] and $CLKB\uparrow$ to A0–A35 [‡]	3	11	3	13	3	15	ns
$t_{pd}(M-DV)$ Propagation delay time, MBA to A0–A35 valid and MBB to B0–B35 valid	1	11	1	11.5	1	12	ns
$t_{pd}(D-PE)$ Propagation delay time, A0-A35 valid to \overline{PEFA} valid; B0-B35 valid to \overline{PEFB} valid	3	10	3	11	3	13	ns
$t_{pd}(O-PE)$ Propagation delay time, ODD/EVEN to \overline{PEFA} and \overline{PEFB}	3	11	3	12	3	14	ns
$t_{pd}(O-PB)$ [§] Propagation delay time, ODD/EVEN to parity bits (A8, A17, A26, A35) and (B8, B17, B26, B35)	2	11	2	12	2	14	ns
$t_{pd}(E-PE)$ Propagation delay time, $\overline{W/RA}$, \overline{CSA} , \overline{ENA} , \overline{MBA} , or \overline{PGA} to \overline{PEFA} ; $\overline{W/RB}$, \overline{CSB} , \overline{ENB} , \overline{MBB} , or \overline{PGB} to \overline{PEFB}	1	11	1	12	1	14	ns
$t_{pd}(E-PB)$ [§] Propagation delay time, $\overline{W/RA}$, \overline{CSA} , \overline{ENA} , \overline{MBA} , or \overline{PGA} to parity bits (A8, A17, A26, A35); $\overline{W/RB}$, \overline{CSB} , \overline{ENB} , \overline{MBB} , or \overline{PGB} to parity bits (B8, B17, B26, B35)	3	12	3	13	3	14	ns
$t_{pd}(R-F)$ Propagation delay time, \overline{RST} to \overline{AEA} , \overline{AEB} low and \overline{AFA} , \overline{AFB} , $\overline{MBF1}$, $\overline{MBF2}$ high.	1	15	1	20	1	30	ns
t_{en} Enable time, \overline{CSA} and $\overline{W/RA}$ low to A0–A35 active and \overline{CSB} low and $\overline{W/RB}$ high to B0–B35 active	2	10	2	12	2	14	ns
t_{dis} Disable time, \overline{CSA} or $\overline{W/RA}$ high to A0–A35 at high impedance and \overline{CSB} high or $\overline{W/RB}$ low to B0–B35 at high impedance	1	8	1	9	1	11	ns

[†] Writing data to the mail1 register when the B0–B35 outputs are active and MBB is high

[‡] Writing data to the mail2 register when the A0–A35 outputs are active and MBA is high

[§] Only applies when reading data from a mail register

PARAMETER MEASUREMENT INFORMATION

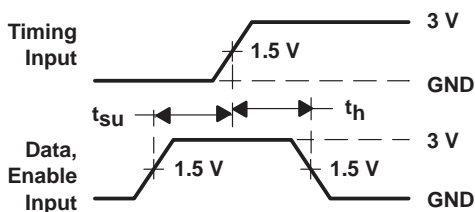
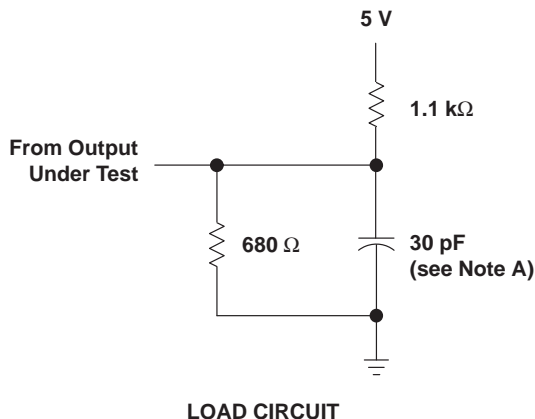

VOLTAGE WAVEFORMS
SETUP AND HOLD TIMES

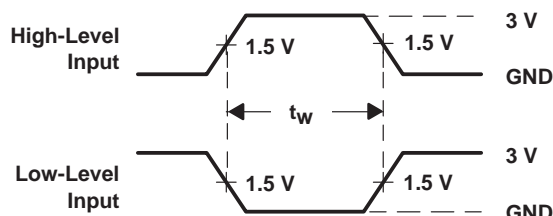

VOLTAGE WAVEFORMS
PULSE DURATIONS

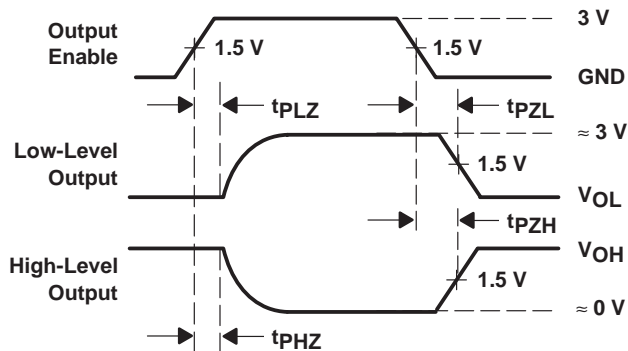

VOLTAGE WAVEFORMS
ENABLE AND DISABLE TIMES

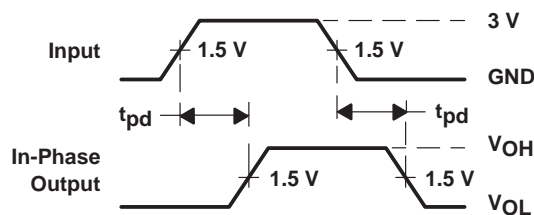

VOLTAGE WAVEFORMS
PROPAGATION DELAY TIMES

- NOTES: A. Includes probe and jig capacitance
 B. t_{PZL} and t_{PZH} are the same as t_{en} .
 C. t_{PLZ} and t_{PHZ} are the same as t_{dis} .

Figure 20. Load Circuit and Voltage Waveforms

TYPICAL CHARACTERISTICS

SUPPLY CURRENT
vs
CLOCK FREQUENCY

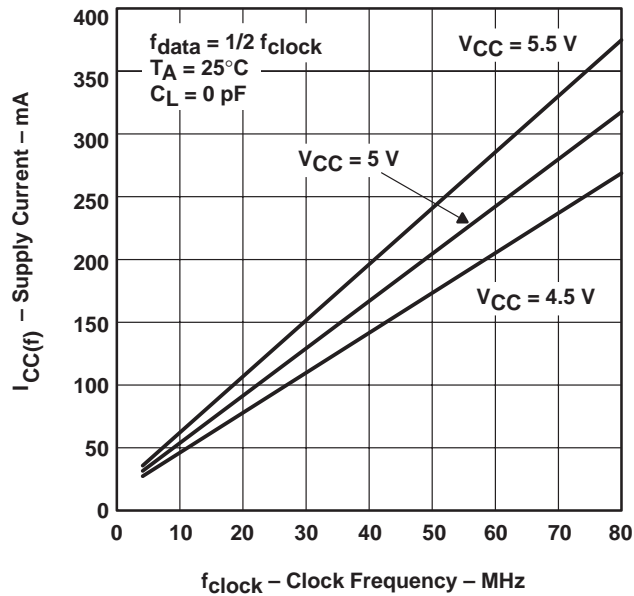

Figure 21

IMPORTANT NOTICE

Texas Instruments and its subsidiaries (TI) reserve the right to make changes to their products or to discontinue any product or service without notice, and advise customers to obtain the latest version of relevant information to verify, before placing orders, that information being relied on is current and complete. All products are sold subject to the terms and conditions of sale supplied at the time of order acknowledgement, including those pertaining to warranty, patent infringement, and limitation of liability.

TI warrants performance of its semiconductor products to the specifications applicable at the time of sale in accordance with TI's standard warranty. Testing and other quality control techniques are utilized to the extent TI deems necessary to support this warranty. Specific testing of all parameters of each device is not necessarily performed, except those mandated by government requirements.

CERTAIN APPLICATIONS USING SEMICONDUCTOR PRODUCTS MAY INVOLVE POTENTIAL RISKS OF DEATH, PERSONAL INJURY, OR SEVERE PROPERTY OR ENVIRONMENTAL DAMAGE ("CRITICAL APPLICATIONS"). TI SEMICONDUCTOR PRODUCTS ARE NOT DESIGNED, AUTHORIZED, OR WARRANTED TO BE SUITABLE FOR USE IN LIFE-SUPPORT DEVICES OR SYSTEMS OR OTHER CRITICAL APPLICATIONS. INCLUSION OF TI PRODUCTS IN SUCH APPLICATIONS IS UNDERSTOOD TO BE FULLY AT THE CUSTOMER'S RISK.

In order to minimize risks associated with the customer's applications, adequate design and operating safeguards must be provided by the customer to minimize inherent or procedural hazards.

TI assumes no liability for applications assistance or customer product design. TI does not warrant or represent that any license, either express or implied, is granted under any patent right, copyright, mask work right, or other intellectual property right of TI covering or relating to any combination, machine, or process in which such semiconductor products or services might be or are used. TI's publication of information regarding any third party's products or services does not constitute TI's approval, warranty or endorsement thereof.

Looking for pricing, stock, or lifecycle information?

Click below to explore more details on WIN SOURCE:

 [View SN74ABT3612-20PQ on WIN SOURCE](#)

 [Texas Instruments](#) Information

Optimize Your Supply Chain with WIN SOURCE Solutions

-  Global Sourcing Solution
-  Obsolete Management
-  Cost Control Management
-  Shortage Management
-  Alternative Solution
-  Excess Inventory Management