



**THE DATASHEET OF
SN74ABT3614-15PQ**



SN74ABT3614 64 × 36 × 2 CLOCKED BIDIRECTIONAL FIRST-IN, FIRST-OUT MEMORY WITH BUS MATCHING AND BYTE SWAPPING

SCBS126H – JUNE 1992 – REVISED APRIL 2000

- Free-Running CLKA and CLKB Can Be Asynchronous or Coincident
- Two Independent 64 × 36 Clocked FIFOs Buffering Data in Opposite Directions
- Mailbox-Bypass Register for Each FIFO
- Dynamic Port-B Bus Sizing of 36 Bits (Long Word), 18 Bits (Word), and 9 Bits (Byte)
- Selection of Big- or Little-Endian Format for Word and Byte Bus Sizes
- Three Modes of Byte-Order Swapping on Port B
- Programmable Almost-Full and Almost-Empty Flags
- Microprocessor Interface Control Logic
- $\overline{\text{EFA}}$, $\overline{\text{FFA}}$, $\overline{\text{AEA}}$, and $\overline{\text{AFA}}$ Flags Synchronized by CLKA
- $\overline{\text{EFB}}$, $\overline{\text{FFB}}$, $\overline{\text{AEB}}$, and $\overline{\text{AFB}}$ Flags Synchronized by CLKB
- Passive Parity Checking on Each Port
- Parity Generation Can Be Selected for Each Port
- Low-Power Advanced BiCMOS Technology
- Supports Clock Frequencies up to 67 MHz
- Fast Access Times of 10 ns
- Package Options Include 120-Pin Thin Quad Flat (PCB) and 132-Pin Quad Flat (PQ) Packages

description

The SN74ABT3614 is a high-speed, low-power BiCMOS bidirectional clocked FIFO memory. It supports clock frequencies up to 67 MHz and has read-access times as fast as 10 ns. Two independent 64 × 36 dual-port SRAM FIFOs in this device buffer data in opposite directions. Each FIFO has flags to indicate empty and full conditions and two programmable flags, almost full ($\overline{\text{AF}}$) and almost empty ($\overline{\text{AE}}$) to indicate when a selected number of words is stored in memory. FIFO data on port B can be input and output in 36-bit, 18-bit, and 9-bit formats, with a choice of big- or little-endian configurations. Three modes of byte-order swapping are possible with any bus-size selection. Communication between each port can bypass the FIFOs via two 36-bit mailbox registers. Each mailbox register has a flag to signal when new mail has been stored. Parity is checked passively on each port and can be ignored if not desired. Parity generation can be selected for data read from each port.

The SN74ABT3614 is a clocked FIFO, which means each port employs a synchronous interface. All data transfers through a port are gated to the low-to-high transition of a continuous (free-running) port clock by enable signals. The continuous clocks for each port are independent of one another and can be asynchronous or coincident. The enables for each port are arranged to provide a simple bidirectional interface between microprocessors and/or buses controlled by a synchronous interface.

The full flag and almost-full flag of a FIFO are two-stage synchronized to the port clock that writes data to its array. The empty flag and almost-empty flag of a FIFO are two-stage synchronized to the port clock that reads data from its array.

The SN74ABT3614 is characterized for operation from 0°C to 70°C.

For more information on this device family, see the following application reports:

- *FIFO Mailbox-Bypass Registers: Using Bypass Registers to Initialize DMA Control* (literature number SCAA007)
- *Advanced Bus-Matching/Byte-Swapping Features for Internetworking FIFO Applications* (literature number SCAA014)
- *Parity-Generate and Parity-Check Features for High-Bandwidth-Computing FIFO Applications* (literature number SCAA015)
- *Internetworking the SN74ABT3614* (literature number SCAA015)
- *Metastability Performance of Clocked FIFOs* (literature number SCZA004)

Please be aware that an important notice concerning availability, standard warranty, and use in critical applications of Texas Instruments semiconductor products and disclaimers thereto appears at the end of this data sheet.



PRODUCTION DATA information is current as of publication date. Products conform to specifications per the terms of Texas Instruments standard warranty. Production processing does not necessarily include testing of all parameters.

 **TEXAS
INSTRUMENTS**

POST OFFICE BOX 655303 • DALLAS, TEXAS 75265

Copyright © 2000, Texas Instruments Incorporated

SN74ABT3614

64 × 36 × 2 CLOCKED BIDIRECTIONAL FIRST-IN, FIRST-OUT MEMORY WITH BUS MATCHING AND BYTE SWAPPING

SCBS126H – JUNE 1992 – REVISED APRIL 2000

PCB PACKAGE (TOP VIEW)

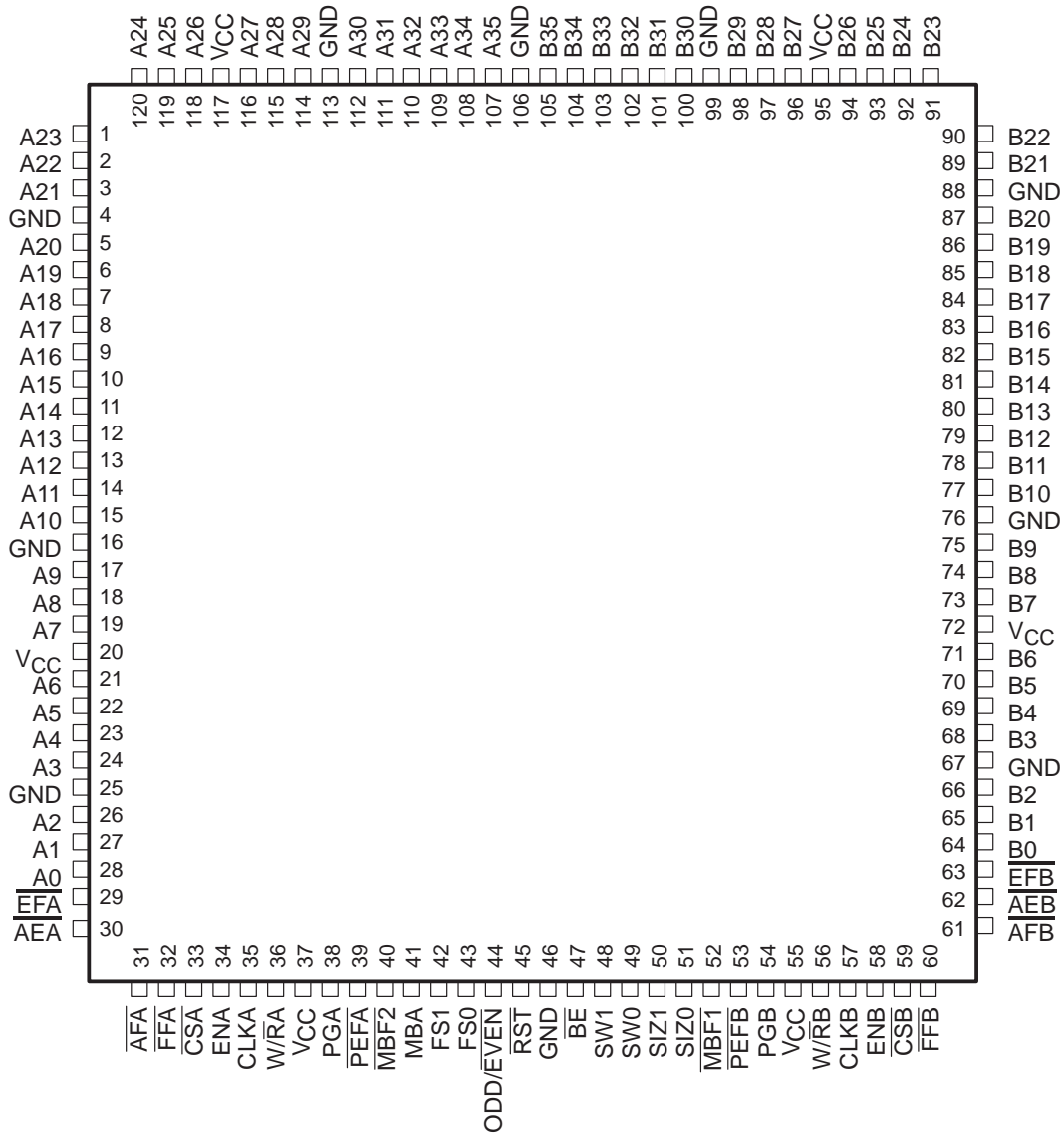

SN74ABT3614

64 × 36 × 2 CLOCKED BIDIRECTIONAL FIRST-IN, FIRST-OUT MEMORY WITH BUS MATCHING AND BYTE SWAPPING

SCBS126H – JUNE 1992 – REVISED APRIL 2000

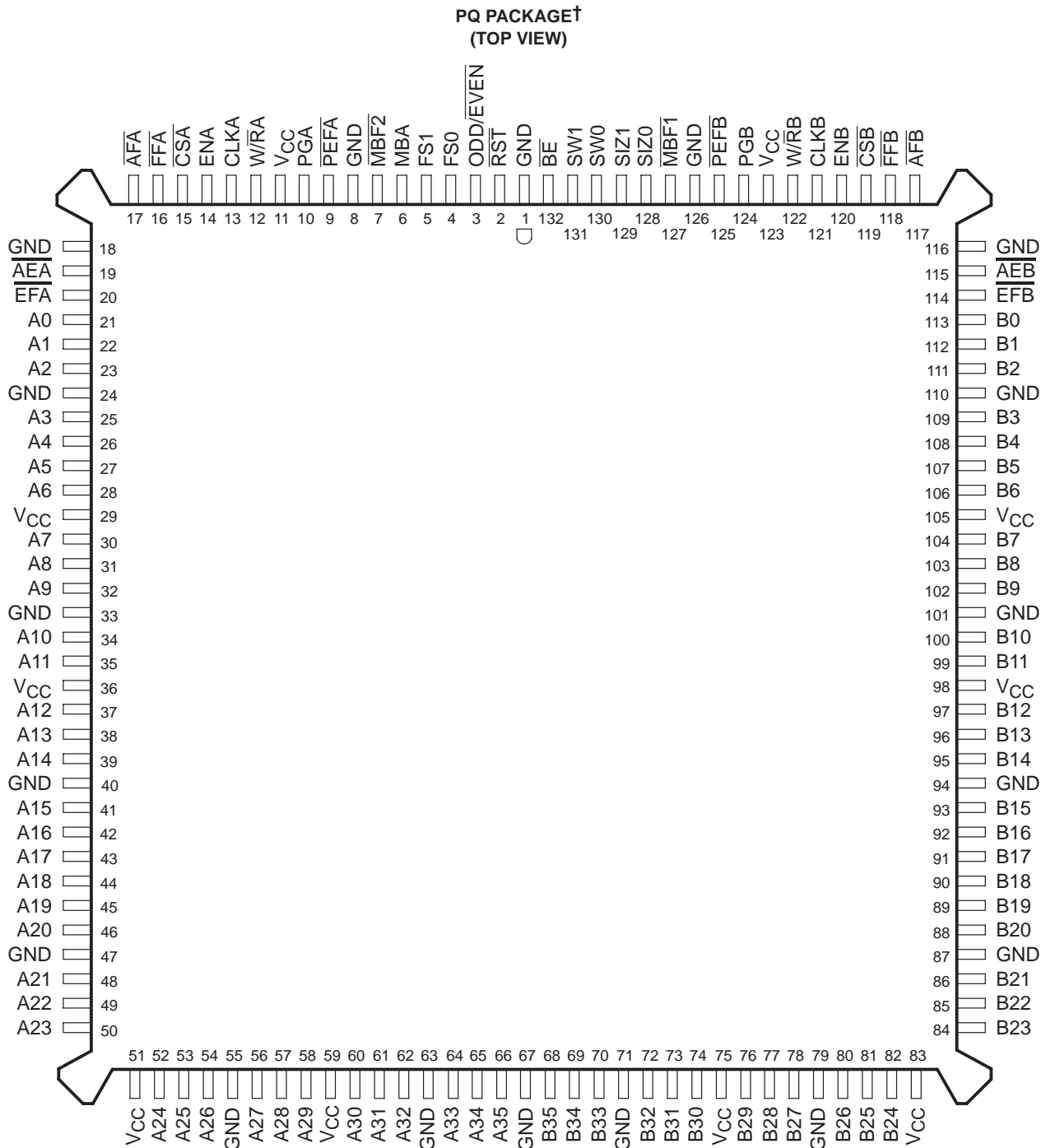

NC – No internal connection

† Uses Yamaichi socket IC51-1324-828

SN74ABT3614

64 × 36 × 2 CLOCKED BIDIRECTIONAL FIRST-IN, FIRST-OUT MEMORY WITH BUS MATCHING AND BYTE SWAPPING

SCBS126H – JUNE 1992 – REVISED APRIL 2000

functional block diagram

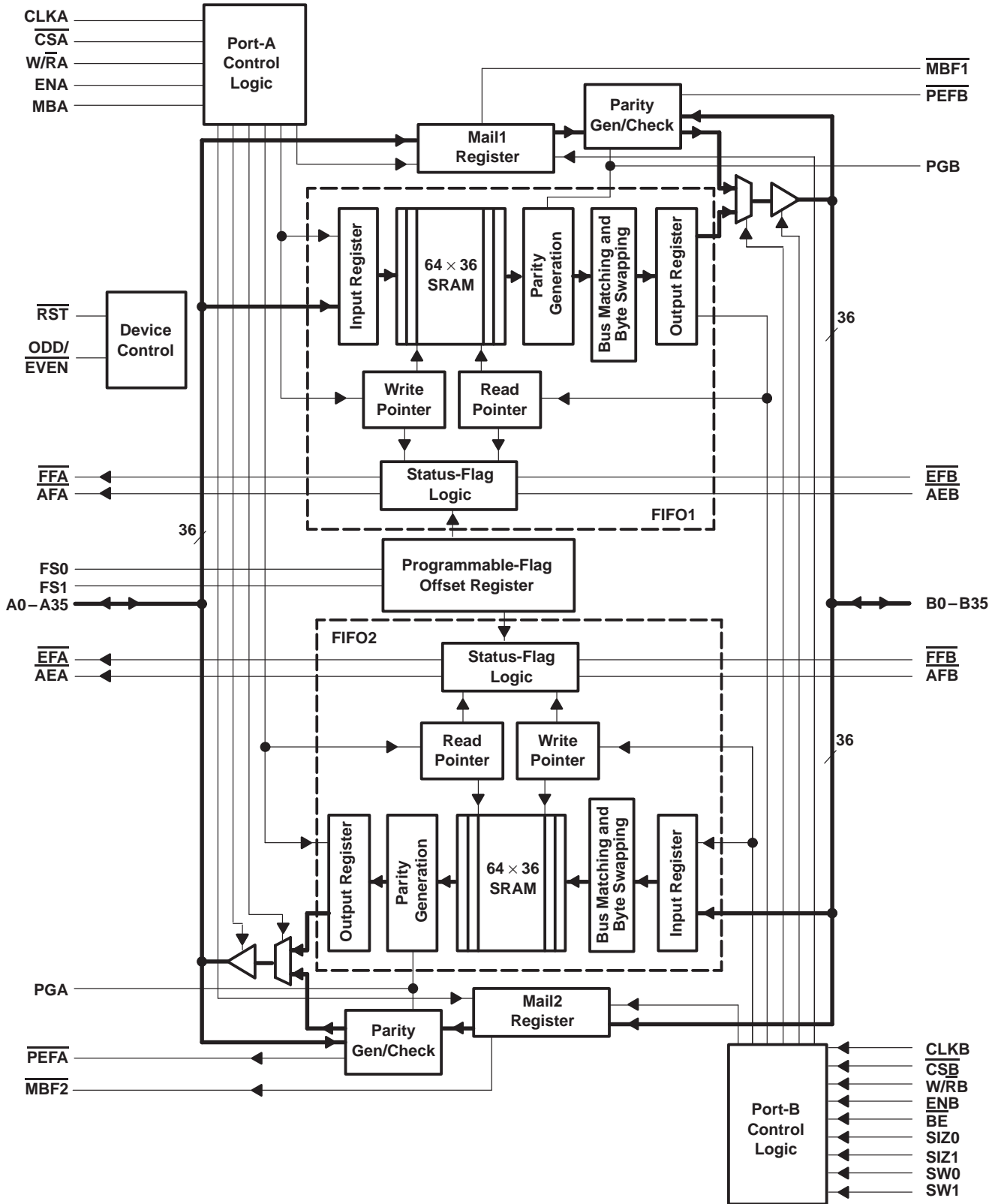

SN74ABT3614

**64 × 36 × 2 CLOCKED BIDIRECTIONAL FIRST-IN, FIRST-OUT MEMORY
WITH BUS MATCHING AND BYTE SWAPPING**

SCBS126H – JUNE 1992 – REVISED APRIL 2000

Terminal Functions

TERMINAL NAME	I/O	DESCRIPTION
A0–A35	I/O	Port-A data. The 36-bit bidirectional data port for side A.
\overline{AEA}	O (port A)	Port-A almost-empty flag. Programmable flag synchronized to CLKA. \overline{AEA} is low when the number of 36-bit words in FIFO2 is less than or equal to the value in offset register X.
\overline{AEB}	O (port B)	Port-B almost-empty flag. Programmable flag synchronized to CLKB. \overline{AEB} is low when the number of 36-bit words in FIFO1 is less than or equal to the value in offset register X.
\overline{AFA}	O (port A)	Port-A almost-full flag. Programmable flag synchronized to CLKA. \overline{AFA} is low when the number of 36-bit empty locations in FIFO1 is less than or equal to the value in offset register X.
\overline{AFB}	O (port B)	Port-B almost-full flag. Programmable flag synchronized to CLKB. \overline{AFB} is low when the number of 36-bit empty locations in FIFO2 is less than or equal to the value in offset register X.
B0–B35	I/O	Port-B data. The 36-bit bidirectional data port for side B.
\overline{BE}	I	Big-endian select. Selects the bytes on port B used during byte or word data transfer. A low on \overline{BE} selects the most-significant bytes on B0–B35 for use, and a high selects the least-significant bytes.
CLKA	I	Port-A clock. CLKA is a continuous clock that synchronizes all data transfers through port A and can be asynchronous or coincident to CLKB. \overline{EFA} , \overline{FFA} , \overline{AFA} , and \overline{AEA} are synchronized to the low-to-high transition of CLKA.
CLKB	I	Port-B clock. CLKB is a continuous clock that synchronizes all data transfers through port B and can be asynchronous or coincident to CLKA. Port-B byte swapping and data-port-sizing operations are also synchronous to the low-to-high transition of CLKB. \overline{EFB} , \overline{FFB} , \overline{AFB} , and \overline{AEB} are synchronized to the low-to-high transition of CLKB.
\overline{CSA}	I	Port-A chip select. \overline{CSA} must be low to enable a low-to-high transition of CLKA to read or write data on port A. The A0–A35 outputs are in the high-impedance state when \overline{CSA} is high.
\overline{CSB}	I	Port-B chip select. \overline{CSB} must be low to enable a low-to-high transition of CLKB to read or write data on port B. The B0–B35 outputs are in the high-impedance state when \overline{CSB} is high.
\overline{EFA}	O (port A)	Port-A empty flag. \overline{EFA} is synchronized to the low-to-high transition of CLKA. When \overline{EFA} is low, FIFO2 is empty and reads from its memory are disabled. Data can be read from FIFO2 to the output register when \overline{EFA} is high. \overline{EFA} is forced low when the device is reset and is set high by the second low-to-high transition of CLKA after data is loaded into empty FIFO2 memory.
\overline{EFB}	O (port B)	Port-B empty flag. \overline{EFB} is synchronized to the low-to-high transition of CLKB. When \overline{EFB} is low, FIFO1 is empty and reads from its memory are disabled. Data can be read from FIFO1 to the output register when \overline{EFB} is high. \overline{EFB} is forced low when the device is reset and is set high by the second low-to-high transition of CLKB after data is loaded into empty FIFO1 memory.
ENA	I	Port-A enable. ENA must be high to enable a low-to-high transition of CLKA to read or write data on port A.
ENB	I	Port-B enable. ENB must be high to enable a low-to-high transition of CLKB to read or write data on port B.
\overline{FFA}	O (port A)	Port-A full flag. \overline{FFA} is synchronized to the low-to-high transition of CLKA. When \overline{FFA} is low, FIFO1 is full and writes to its memory are disabled. \overline{FFA} is forced low when the device is reset and is set high by the second low-to-high transition of CLKA after reset.
\overline{FFB}	O (port B)	Port-B full flag. \overline{FFB} is synchronized to the low-to-high transition of CLKB. When \overline{FFB} is low, FIFO2 is full and writes to its memory are disabled. \overline{FFB} is forced low when the device is reset and is set high by the second low-to-high transition of CLKB after reset.
FS1, FS0	I	Flag offset selects. The low-to-high transition of \overline{RST} latches the values of FS0 and FS1, which selects one of four preset values for the AE flag and AF flag offset.
MBA	I	Port-A mailbox select. A high level on MBA chooses a mailbox register for a port-A read or write operation. When the A0–A35 outputs are active, a high level on MBA selects data from the mail2 register for output and a low level selects FIFO2 output register data for output.
$\overline{MBF1}$	O	Mail1 register flag. $\overline{MBF1}$ is set low by the low-to-high transition of CLKA that writes data to the mail1 register. Writes to the mail1 register are inhibited while $\overline{MBF1}$ is low. $\overline{MBF1}$ is set high by a low-to-high transition of CLKB when a port-B read is selected and both SIZ1 and SIZ0 are high. $\overline{MBF1}$ is set high when the device is reset.
$\overline{MBF2}$	O	Mail2 register flag. $\overline{MBF2}$ is set low by the low-to-high transition of CLKB that writes data to the mail2 register. Writes to the mail2 register are inhibited while $\overline{MBF2}$ is low. $\overline{MBF2}$ is set high by a low-to-high transition of CLKA when a port-A read is selected and MBA is high. $\overline{MBF2}$ is set high when the device is reset.



64 × 36 × 2 CLOCKED BIDIRECTIONAL FIRST-IN, FIRST-OUT MEMORY WITH BUS MATCHING AND BYTE SWAPPING

SCBS126H – JUNE 1992 – REVISED APRIL 2000

Terminal Functions (Continued)

TERMINAL NAME	I/O	DESCRIPTION
$\overline{\text{ODD/EVEN}}$	I	Odd/even parity select. Odd parity is checked on each port when $\overline{\text{ODD/EVEN}}$ is high and even parity is checked when $\overline{\text{ODD/EVEN}}$ is low. $\overline{\text{ODD/EVEN}}$ also selects the type of parity generated for each port if parity generation is enabled for a read operation.
$\overline{\text{PEFA}}$	O (port A)	Port-A parity-error flag. When any byte applied to terminals A0–A35 fails parity, $\overline{\text{PEFA}}$ is low. Bytes are organized as A0–A8, A9–A17, A18–A26, and A27–A35, with the most-significant bit of each byte serving as the parity bit. The type of parity checked is determined by the state of the $\overline{\text{ODD/EVEN}}$ input. The parity trees used to check the A0–A35 inputs are shared by the mail2 register to generate parity if parity generation is selected by PGA; therefore, if a mail2 read with parity generation is set up by having $\overline{\text{W/RA}}$ low, MBA high, and PGA high, the $\overline{\text{PEFA}}$ flag is forced high, regardless of the state of the A0–A35 inputs.
$\overline{\text{PEFB}}$	O (port B)	Port-B parity-error flag. When any valid byte applied to terminals B0–B35 fails parity, $\overline{\text{PEFB}}$ is low. Bytes are organized as B0–B8, B9–B17, B18–B26, and B27–B35, with the most-significant bit of each byte serving as the parity bit. A byte is valid when it is used by the bus size selected for port B. The type of parity checked is determined by the state of the $\overline{\text{ODD/EVEN}}$ input. The parity trees used to check the B0–B35 inputs are shared by the mail1 register to generate parity if parity generation is selected by PGB; therefore, if a mail1 read with parity generation is set up by having $\overline{\text{W/RB}}$ low, SIZ1 and SIZ0 high, and PGB high, the $\overline{\text{PEFB}}$ flag is forced high, regardless of the state of the B0–B35 inputs.
PGA	I	Port-A parity generation. Parity is generated for data reads from port A when PGA is high. The type of parity generated is selected by the state of the $\overline{\text{ODD/EVEN}}$ input. Bytes are organized as A0–A8, A9–A17, A18–A26, and A27–A35. The generated parity bits are output in the most-significant bit of each byte.
PGB	I	Port-B parity generation. Parity is generated for data reads from port B when PGB is high. The type of parity generated is selected by the state of the $\overline{\text{ODD/EVEN}}$ input. Bytes are organized as B0–B8, B9–B17, B18–B26, and B27–B35. The generated parity bits are output in the most-significant bit of each byte.
$\overline{\text{RST}}$	I	Reset. To reset the device, four low-to-high transitions of CLKA and four low-to-high transitions of CLKB must occur while $\overline{\text{RST}}$ is low. This sets the $\overline{\text{AFA}}$, $\overline{\text{AFB}}$, $\overline{\text{MBF1}}$, and $\overline{\text{MBF2}}$ flags high and the $\overline{\text{EFA}}$, $\overline{\text{EFB}}$, $\overline{\text{AEA}}$, $\overline{\text{AEB}}$, $\overline{\text{FFA}}$, and $\overline{\text{FFB}}$ flags low. The low-to-high transition of $\overline{\text{RST}}$ latches the status of the FS1 and FS0 inputs to select $\overline{\text{AF}}$ flag and $\overline{\text{AE}}$ flag offset.
SIZ0, SIZ1	I (port B)	Port-B bus-size selects. The low-to-high transition of CLKB latches the states of SIZ0, SIZ1, and $\overline{\text{BE}}$, and the following low-to-high transition of CLKB implements the latched states as a port-B bus size. Port-B bus sizes can be long word, word, or byte. A high on both SIZ0 and SIZ1 accesses the mailbox registers for a port-B 36-bit write or read.
SW0, SW1	I (port B)	Port-B byte-swap selects. At the beginning of each long word transfer, one of four modes of byte-order swapping is selected by SW0 and SW1. The four modes are no swap, byte swap, word swap, and byte-word swap. Byte-order swapping is possible with any bus-size selection.
$\overline{\text{W/RA}}$	I	Port-A write/read select. $\overline{\text{W/RA}}$ high selects a write operation and a low selects a read operation on port A for a low-to-high transition of CLKA. The A0–A35 outputs are in the high-impedance state when $\overline{\text{W/RA}}$ is high.
$\overline{\text{W/RB}}$	I	Port-B write/read select. $\overline{\text{W/RB}}$ high selects a write operation and a low selects a read operation on port B for a low-to-high transition of CLKB. The B0–B35 outputs are in the high-impedance state when $\overline{\text{W/RB}}$ is high.

detailed description

reset

The SN74ABT3614 is reset by taking the reset ($\overline{\text{RST}}$) input low for at least four port-A clock (CLKA) and four port-B clock (CLKB) low-to-high transitions. The reset input can switch asynchronously to the clocks. A device reset initializes the internal read and write pointers of each FIFO and forces the full flags ($\overline{\text{FFA}}$, $\overline{\text{FFB}}$) low, the empty flags ($\overline{\text{EFA}}$, $\overline{\text{EFB}}$) low, the almost-empty flags ($\overline{\text{AEA}}$, $\overline{\text{AEB}}$) low, and the almost-full flags ($\overline{\text{AFA}}$, $\overline{\text{AFB}}$) high. A reset also forces the mailbox flags ($\overline{\text{MBF1}}$, $\overline{\text{MBF2}}$) high. After a reset, $\overline{\text{FFA}}$ is set high after two low-to-high transitions of CLKA and $\overline{\text{FFB}}$ is set high after two low-to-high transitions of CLKB. The device must be reset after power up before data is written to its memory.

A low-to-high transition on $\overline{\text{RST}}$ loads the almost-full and almost-empty offset register (X) with the value selected by the flag-select (FS0, FS1) inputs. The values that can be loaded into the register are shown in Table 1.

reset (continued)

Table 1. Flag Programming

FS1	FS0	$\overline{\text{RST}}$	AF AND AE FLAG OFFSET REGISTER (X)
H	H	↑	16
H	L	↑	12
L	H	↑	8
L	L	↑	4

FIFO write/read operation

The state of the port-A data (A0–A35) outputs is controlled by the port-A chip select ($\overline{\text{CSA}}$) and the port-A write/read select ($\overline{\text{W/RA}}$). The A0–A35 outputs are in the high-impedance state when either $\overline{\text{CSA}}$ or $\overline{\text{W/RA}}$ is high. The A0–A35 outputs are active when both $\overline{\text{CSA}}$ and $\overline{\text{W/RA}}$ are low. Data is loaded into FIFO1 from the A0–A35 inputs on a low-to-high transition of CLK_A when $\overline{\text{CSA}}$ is low, $\overline{\text{W/RA}}$ is high, EN_A is high, MB_A is low, and $\overline{\text{FFA}}$ is high. Data is read from FIFO2 to the A0–A35 outputs by a low-to-high transition of CLK_A when $\overline{\text{CSA}}$ is low, $\overline{\text{W/RA}}$ is low, EN_A is high, MB_A is low, and $\overline{\text{EFA}}$ is high (see Table 2).

Table 2. Port-A Enable Function Table

$\overline{\text{CSA}}$	$\overline{\text{W/RA}}$	EN _A	MB _A	CLK _A	A0–A35 OUTPUTS	PORT FUNCTION
H	X	X	X	X	In high-impedance state	None
L	H	L	X	X	In high-impedance state	None
L	H	H	L	↑	In high-impedance state	FIFO1 write
L	H	H	H	↑	In high-impedance state	Mail1 write
L	L	L	L	X	Active, FIFO2 output register	None
L	L	H	L	↑	Active, FIFO2 output register	FIFO2 read
L	L	L	H	X	Active, mail2 register	None
L	L	H	H	↑	Active, mail2 register	Mail2 read (set $\overline{\text{MBF2}}$ high)

The state of the port-B data (B0–B35) outputs is controlled by the port-B chip select ($\overline{\text{CSB}}$) and the port-B write/read select ($\overline{\text{W/RB}}$). The B0–B35 outputs are in the high-impedance state when either $\overline{\text{CSB}}$ or $\overline{\text{W/RB}}$ is high. The B0–B35 outputs are active when both $\overline{\text{CSB}}$ and $\overline{\text{W/RB}}$ are low. Data is loaded into FIFO2 from the B0–B35 inputs on a low-to-high transition of CLK_B when $\overline{\text{CSB}}$ is low, $\overline{\text{W/RB}}$ is high, EN_B is high, $\overline{\text{FFB}}$ is high, and either SIZ₀ or SIZ₁ is low. Data is read from FIFO1 to the B0–B35 outputs by a low-to-high transition of CLK_B when $\overline{\text{CSB}}$ is low, $\overline{\text{W/RB}}$ is low, EN_B is high, $\overline{\text{EFB}}$ is high, and either SIZ₀ or SIZ₁ is low (see Table 3).

The setup- and hold-time constraints to the port clocks for the port-chip selects ($\overline{\text{CSA}}$, $\overline{\text{CSB}}$) and write/read selects ($\overline{\text{W/RA}}$, $\overline{\text{W/RB}}$) are only for enabling write and read operations and are not related to high-impedance control of the data outputs. If a port enable is low during a clock cycle, the port-chip select and write/read select can change states during the setup- and hold-time window of the cycle.

64 × 36 × 2 CLOCKED BIDIRECTIONAL FIRST-IN, FIRST-OUT MEMORY WITH BUS MATCHING AND BYTE SWAPPING

FIFO writer/read operation (continued)

Table 3. Port-B Enable Function Table

CSB	W/RB	ENB	SIZ1, SIZ0	CLKB	B0–B35 OUTPUTS	PORT FUNCTION
H	X	X	X	X	In high-impedance state	None
L	H	L	X	X	In high-impedance state	None
L	H	H	One, both low	↑	In high-impedance state	FIFO2 write
L	H	H	Both high	↑	In high-impedance state	Mail2 write
L	L	L	One, both low	X	Active, FIFO1 output register	None
L	L	H	One, both low	↑	Active, FIFO1 output register	FIFO1 read
L	L	L	Both high	X	Active, mail1 register	None
L	L	H	Both high	↑	Active, mail1 register	Mail1 read (set MBF1 high)

synchronized FIFO flags

Each FIFO flag is synchronized to its port clock through two flip-flop stages. This is done to improve flag reliability by reducing the probability of metastable events on the output when CLKA and CLKB operate asynchronously to one another. \overline{EFA} , \overline{AEA} , \overline{FFA} , and \overline{AFA} are synchronized to CLKA. \overline{EFB} , \overline{AEB} , \overline{FFB} , and \overline{AFB} are synchronized to CLKB. Tables 4 and 5 show the relationship of each port flag to FIFO1 and FIFO2.

Table 4. FIFO1 Flag Operation

NUMBER OF 36-BIT WORDS IN FIFO1†	SYNCHRONIZED TO CLKB		SYNCHRONIZED TO CLKA	
	\overline{EFB}	\overline{AEB}	\overline{AFA}	\overline{FFA}
0	L	L	H	H
1 to X	H	L	H	H
(X + 1) to [64 – (X + 1)]	H	H	H	H
(64 – X) to 63	H	H	L	H
64	H	H	L	L

† X is the value in the \overline{AE} flag and \overline{AF} flag offset register.

Table 5. FIFO2 Flag Operation

NUMBER OF 36-BIT WORDS IN FIFO2†	SYNCHRONIZED TO CLKA		SYNCHRONIZED TO CLKB	
	\overline{EFA}	\overline{AEA}	\overline{AFB}	\overline{FFB}
0	L	L	H	H
1 to X	H	L	H	H
(X + 1) to [64 – (X + 1)]	H	H	H	H
(64 – X) to 63	H	H	L	H
64	H	H	L	L

† X is the value in the \overline{AE} flag and \overline{AF} flag offset register.

empty flags (\overline{EFA} , \overline{EFB})

The FIFO empty flag is synchronized to the port clock that reads data from its array. When the empty flag is high, new data can be read to the FIFO output register. When the empty flag is low, the FIFO is empty and attempted FIFO reads are ignored. When reading FIFO1 with a byte or word size on port B, \overline{EFB} is set low when the fourth byte or second word of the last long word is read.

The FIFO read pointer is incremented each time a new word is clocked to the output register. A word written to a FIFO can be read to the FIFO output register in a minimum of three cycles of the empty-flag synchronizing clock; therefore, an empty flag is low if a word in memory is the next data to be sent to the FIFO output register and two cycles of the port clock that reads data from the FIFO have not elapsed since the time the word was written. The FIFO empty flag is set high by the second low-to-high transition of the synchronizing clock and the new data word can be read to the FIFO output register in the following cycle.

A low-to-high transition on an empty-flag synchronizing clock begins the first synchronization cycle of a write if the clock transition occurs at time t_{sk1} , or greater, after the write. Otherwise, the subsequent clock cycle can be the first synchronization cycle (see Figures 13 and 14).

full flags (\overline{FFA} , \overline{FFB})

The FIFO full flag is synchronized to the port clock that writes data to its array. When the full flag is high, a memory location is free in the SRAM to receive new data. No memory locations are free when the full flag is low and attempted writes to the FIFO are ignored.

Each time a word is written to a FIFO, the write pointer is incremented. From the time a word is read from a FIFO, the previous memory location is ready to be written in a minimum of three cycles of the full-flag synchronizing clock. A full flag is low if less than two cycles of the full-flag synchronizing clock have elapsed since the next memory write location has been read. The second low-to-high transition on the full-flag synchronizing clock after the read sets the full flag high and data can be written in the following clock cycle.

A low-to-high transition on a full-flag synchronizing clock begins the first synchronization cycle of a read if the clock transition occurs at time t_{sk1} , or greater, after the read. Otherwise, the subsequent clock cycle can be the first synchronization cycle (see Figures 15 and 16).

almost-empty flags (\overline{AEA} , \overline{AEB})

The FIFO almost-empty flag is synchronized to the port clock that reads data from its array. The almost-empty state is defined by the value of the almost-full and almost-empty offset register (X). This register is loaded with one of four preset values during a device reset (see *reset*). An \overline{AE} flag is low when the FIFO contains X or fewer long words in memory and is high when the FIFO contains (X + 1) or more long words.

Two low-to-high transitions of the \overline{AE} -flag synchronizing clock are required after a FIFO write for the \overline{AE} flag to reflect the new level of fill; therefore, the \overline{AE} flag of a FIFO containing (X + 1) or more long words remains low if two cycles of the synchronizing clock have not elapsed since the write that filled the memory to the (X + 1) level. An \overline{AE} flag is set high by the second low-to-high transition of the synchronizing clock after the FIFO write that fills memory to the (X + 1) level. A low-to-high transition of an \overline{AE} flag synchronizing clock begins the first synchronization cycle if it occurs at time t_{sk2} , or greater, after the write that fills the FIFO to (X + 1) long words. Otherwise, the subsequent synchronizing clock cycle can be the first synchronization cycle (see Figures 17 and 18).

almost-full flags (\overline{AFA} , \overline{AFB})

The FIFO almost-full flag is synchronized to the port clock that writes data to its array. The almost-full state is defined by the value of the almost-full and almost-empty offset register (X). This register is loaded with one of four preset values during a device reset (see *reset*). An almost-full flag is low when the FIFO contains $(64 - X)$ or more long words in memory and is high when the FIFO contains $[64 - (X + 1)]$ or fewer long words.

Two low-to-high transitions of the \overline{AF} -flag synchronizing clock are required after a FIFO read for the \overline{AF} flag to reflect the new level of fill; therefore, the \overline{AF} flag of a FIFO containing $[64 - (X + 1)]$ or fewer words remains low if two cycles of the synchronizing clock have not elapsed since the read that reduced the number of long words in memory to $[64 - (X + 1)]$. An \overline{AF} flag is set high by the second low-to-high transition of the synchronizing clock after the FIFO read that reduces the number of long words in memory to $[64 - (X + 1)]$. A low-to-high transition of an \overline{AF} -flag synchronizing clock begins the first synchronization cycle if it occurs at time t_{sk2} , or greater, after the read that reduces the number of long words in memory to $[64 - (X + 1)]$. Otherwise, the subsequent synchronizing clock cycle can be the first synchronization cycle (see Figures 19 and 20).

mailbox registers

Each FIFO has a 36-bit bypass register to pass command and control information between port A and port B without putting it in queue. The mailbox-select (MBA, MBB) inputs choose between a mail register and a FIFO for a port data-transfer operation. A low-to-high transition on CLKA writes A0–A35 data to the mail1 register when a port-A write is selected by \overline{CSA} , W/\overline{RA} , and ENA, and MBA is high. A low-to-high transition on CLKB writes B0–B35 data to the mail2 register when a port-B write is selected by \overline{CSB} , W/\overline{RB} , and ENB and both SIZ0 and SIZ1 are high. Writing data to a mail register sets the corresponding flag ($\overline{MBF1}$ or $\overline{MBF2}$) low. Attempted writes to a mail register are ignored while the mail flag is low.

When the port-A data outputs (A0–A35) are active, the data on the bus comes from the FIFO2 output register when MBA is low and from the mail2 register when MBA is high. When the port-B data outputs (B0–B35) are active, the data on the bus comes from the FIFO1 output register when either one or both SIZ1 and SIZ0 are low and from the mail2 register when both SIZ1 and SIZ0 are high. The mail1 register flag ($\overline{MBF1}$) is set high by a rising CLKB edge when a port-B read is selected by \overline{CSB} , W/\overline{RB} , and ENB and both SIZ1 and SIZ0 are high. The mail2 register flag ($\overline{MBF2}$) is set high by a rising CLKA edge when a port-A read is selected by \overline{CSA} , W/\overline{RA} , and ENA and MBA is high. The data in the mail register remains intact after it is read and changes only when new data is written to the register.

dynamic bus sizing

The port-B bus can be configured in a 36-bit long word, 18-bit word, or 9-bit byte format for data read from FIFO1 or written to FIFO2. Word- and byte-size bus selections can utilize the most-significant bytes of the bus (big endian) or least-significant bytes of the bus (little endian). Port-B bus size can be changed dynamically and synchronous to CLKB to communicate with peripherals of various bus widths.

The levels applied to the port-B bus-size select (SIZ0, SIZ1) inputs and the big-endian select (\overline{BE}) input are stored on each CLKB low-to-high transition. The stored port-B bus-size selection is implemented by the next rising edge on CLKB according to Figure 1.

Only 36-bit long-word data is written to or read from the two FIFO memories on the SN74ABT3614. Bus-matching operations are done after data is read from the FIFO1 RAM and before data is written to the FIFO2 RAM. Port-B bus sizing does not apply to mail-register operations.

SN74ABT3614
**64 × 36 × 2 CLOCKED BIDIRECTIONAL FIRST-IN, FIRST-OUT MEMORY
 WITH BUS MATCHING AND BYTE SWAPPING**

SCBS126H – JUNE 1992 – REVISED APRIL 2000

dynamic bus sizing (continued)

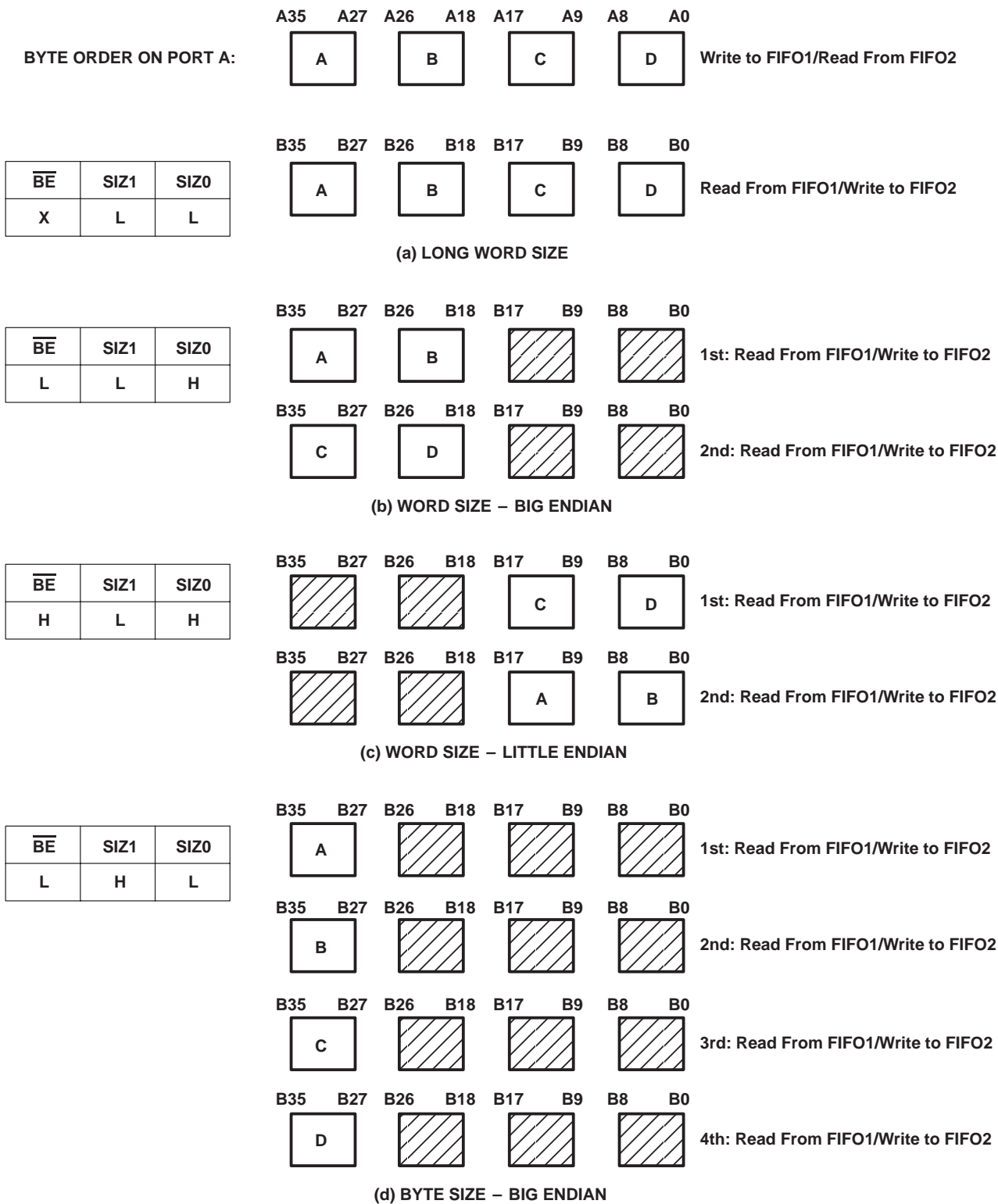

Figure 1. Dynamic Bus Sizing

dynamic bus sizing (continued)

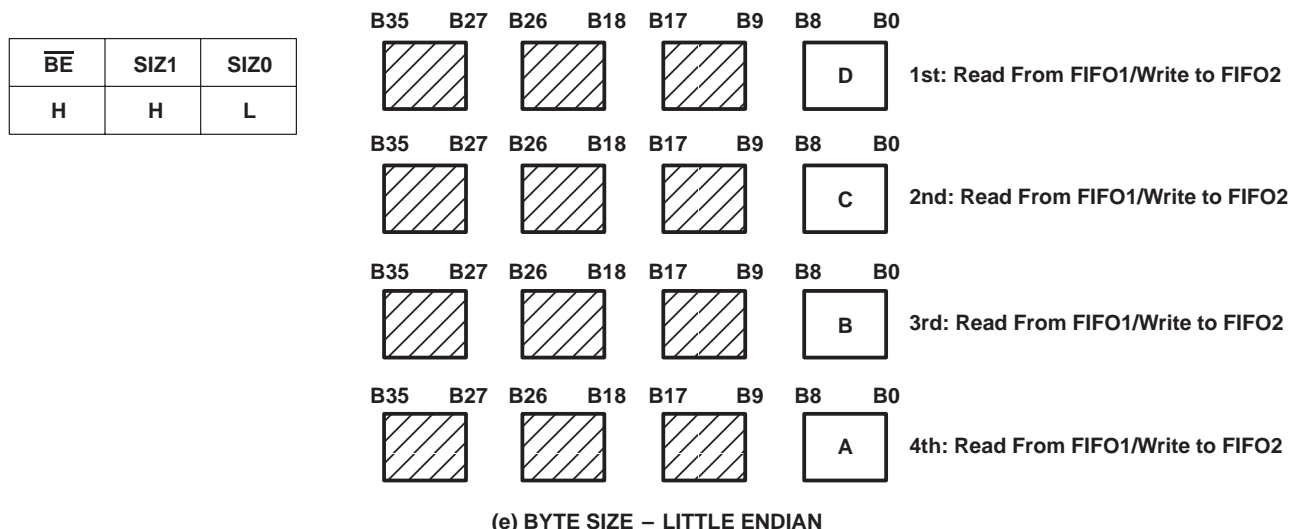

Figure 1. Dynamic Bus Sizing (continued)

bus-matching FIFO1 reads

Data is read from the FIFO1 RAM in 36-bit long-word increments. If a long-word bus size is implemented, the entire long word immediately shifts to the FIFO1 output register. If byte or word size is implemented on port B, only the first one or two bytes appear on the selected portion of the FIFO1 output register with the rest of the long word stored in auxiliary registers. In this case, subsequent FIFO1 reads with the same bus-size implementation output the rest of the long word to the FIFO1 output register in the order shown by Figure 1.

Each FIFO1 read with a new bus-size implementation automatically unloads data from the FIFO1 RAM to its output register and auxiliary registers. Therefore, implementing a new port-B bus size and performing a FIFO1 read before all bytes or words stored in the auxiliary registers have been read results in a loss of the unread long-word data.

When reading data from FIFO1 in byte or word format, the unused B0–B35 outputs remain inactive but static with the unused FIFO1 output register bits holding the last data value to decrease power consumption.

bus-matching FIFO2 writes

Data is written to the FIFO2 RAM in 36-bit long-word increments. FIFO2 writes with a long-word bus size immediately store each long word in FIFO2 RAM. Data written to FIFO2 with a byte or word bus size stores the initial bytes or words in auxiliary registers. The CLKB rising edge that writes the fourth byte or the second word of long word to FIFO2 also stores the entire long word in FIFO2 RAM. The bytes are arranged in the manner shown in Figure 1.

Each FIFO2 write with a new bus-size implementation resets the state machine that controls the data flow from the auxiliary registers to the FIFO2 RAM. Therefore, implementing a new bus size and performing a FIFO2 write before bytes or words stored in the auxiliary registers have been loaded to FIFO2 RAM results in a loss of data.

port-B mail-register access

In addition to selecting port-B bus sizes for FIFO reads and writes, the port-B bus size select (SIZ0, SIZ1) inputs also access the mail registers. When both SIZ0 and SIZ1 are high, the mail1 register is accessed for a port-B long-word read and the mail2 register is accessed for a port-B long-word write. The mail register is accessed immediately. Any bus-sizing operation that is underway is unaffected by the mail-register access. After the mail-register access is complete, the previous FIFO access can resume in the next CLKB cycle. The logic diagram in Figure 2 shows that the previous bus-size selection is preserved when the mail registers are accessed from port B. A port-B bus size is implemented on each rising CLKB edge according to the states of SIZ0_Q, SIZ1_Q, and $\overline{\text{BE}}_Q$.

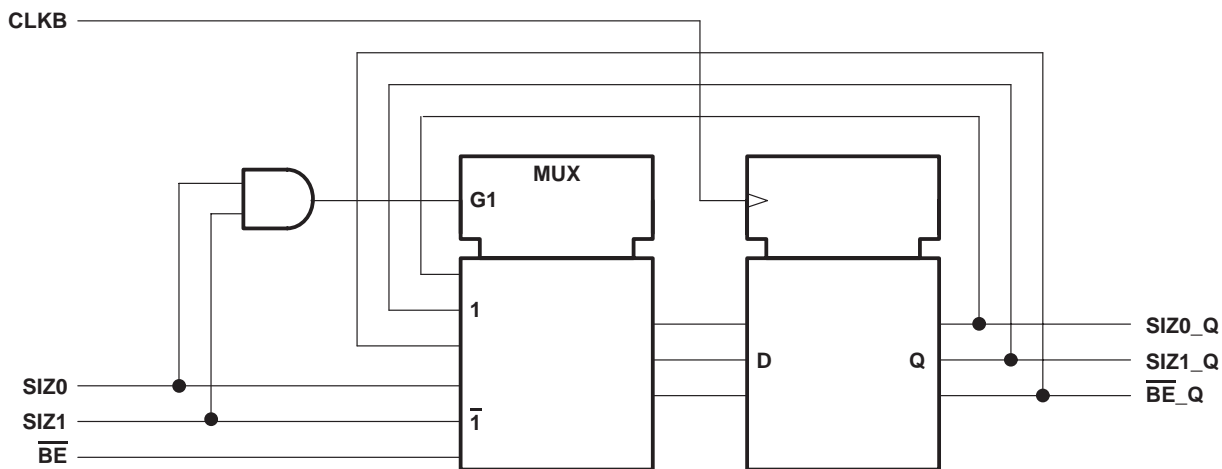

Figure 2. Logic Diagram for SIZ0, SIZ1, and $\overline{\text{BE}}$ Register

byte swapping

The byte-order arrangement of data read from FIFO1 or data written to FIFO2 can be changed synchronous to the rising edge of CLKB. Byte-order swapping is not available for mail-register data. Four modes of byte-order swapping (including no swap) can be done with any data-port-size selection. The order of the bytes is rearranged within the long word, but the bit order within the bytes remains constant.

Byte arrangement is chosen by the port-B swap select (SW0, SW1) inputs on a CLKB rising edge that reads a new long word from FIFO1 or writes a new long word to FIFO2. The byte order chosen on the first byte or first word of a new long-word read from FIFO1 or written to FIFO2 is maintained until the entire long word is transferred, regardless of the SW0 and SW1 states during subsequent writes or reads. Figure 3 is an example of the byte-order swapping available for long words. Performing a byte swap and bus size simultaneously for a FIFO1 read first rearranges the bytes as shown in Figure 3, then outputs the bytes as shown in Figure 1. Simultaneous bus-sizing and byte-swapping operations for FIFO2 writes load the data according to Figure 1, then swap the bytes as shown in Figure 3 when the long word is loaded to FIFO2 RAM.

64 × 36 × 2 CLOCKED BIDIRECTIONAL FIRST-IN, FIRST-OUT MEMORY WITH BUS MATCHING AND BYTE SWAPPING

SCBS126H – JUNE 1992 – REVISED APRIL 2000

byte swapping (continued)

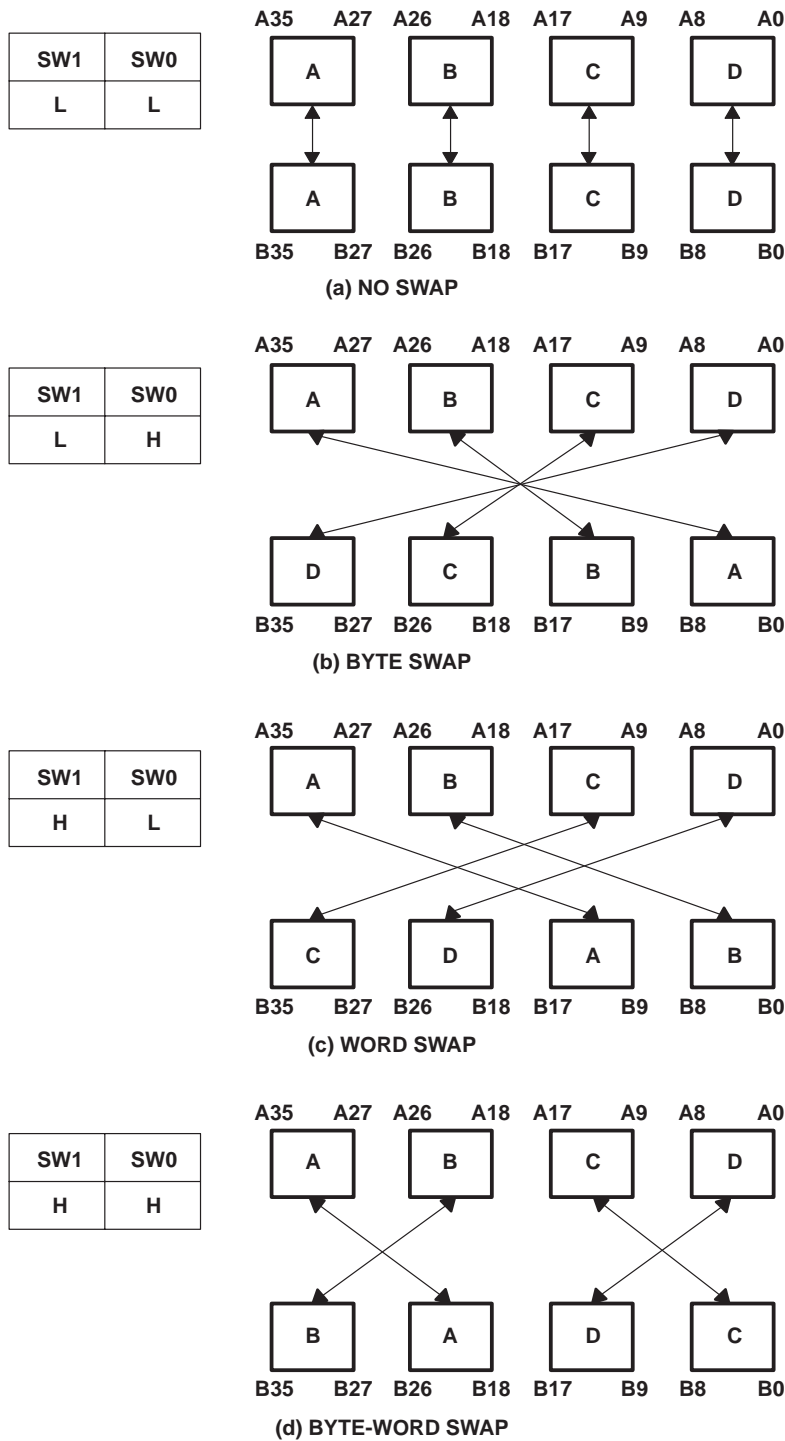

Figure 3. Byte Swapping (Long-Word Size Example)

parity checking

The port-A data inputs (A0–A35) and port-B data inputs (B0–B35) each have four parity trees to check the parity of incoming (or outgoing) data. A parity failure on one or more bytes of the port-A data bus is reported by a low level on the port-A parity error flag ($\overline{\text{PEFA}}$). A parity failure on one or more bytes of the port-B data inputs that are valid for the bus-size implementation is reported by a low level on the port-B parity-error flag ($\overline{\text{PEFB}}$). Odd- or even-parity checking can be selected, and the parity-error flags can be ignored if this feature is not desired.

Parity status is checked on each input bus according to the level of the odd/even parity ($\text{ODD}/\overline{\text{EVEN}}$) select input. A parity error on one or more valid bytes of a port is reported by a low level on the corresponding port-parity-error flag ($\overline{\text{PEFA}}$, $\overline{\text{PEFB}}$) output. Port-A bytes are arranged as A0–A8, A9–A17, A18–A26, and A27–A35. Port-B bytes are arranged as B0–B8, B9–B17, B18–B26, and B27–B35, and its valid bytes are those used in a port-B bus-size implementation. When odd/even parity is selected, a port parity-error flag ($\overline{\text{PEFA}}$, $\overline{\text{PEFB}}$) is low if any valid byte on the port has an odd/even number of low levels applied to the bits.

The four parity trees used to check the A0–A35 inputs are shared by the mail2 register when parity generation is selected for port-A reads ($\text{PGA} = \text{high}$). When a port-A read from the mail2 register with parity generation is selected with $\overline{\text{CSA}}$ low, ENA high, $\text{W}/\overline{\text{RA}}$ low, MBA high, and PGA high, the port-A parity-error flag ($\overline{\text{PEFA}}$) is held high, regardless of the levels applied to the A0–A35 inputs. Likewise, the parity trees used to check the B0–B35 inputs are shared by the mail1 register when parity generation is selected for port-B reads ($\text{PGB} = \text{high}$). When a port-B read from the mail1 register with parity generation is selected with $\overline{\text{CSB}}$ low, ENB high, and $\text{W}/\overline{\text{RB}}$ low, both SIZ0 and SIZ1 high, and PGB high, the port-B parity-error flag ($\overline{\text{PEFB}}$) is held high, regardless of the levels applied to the B0–B35 inputs.

parity generation

A high level on the port-A parity-generate select (PGA) or port-B parity-generate select (PGB) enables the SN74ABT3614 to generate parity bits for port reads from a FIFO or mailbox register. Port-A bytes are arranged as A0–A8, A9–A17, A18–A26, and A27–A35, with the most-significant bit of each byte used as the parity bit. Port-B bytes are arranged as B0–B8, B9–B17, B18–B26, and B27–B35, with the most-significant bit of each byte used as the parity bit. A write to a FIFO or mail register stores the levels applied to all nine inputs of a byte, regardless of the state of the parity-generate select (PGA , PGB) inputs. When data is read from a port with parity generation selected, the lower eight bits of each byte are used to generate a parity bit according to the level on the $\text{ODD}/\overline{\text{EVEN}}$ select. The generated parity bits are substituted for the levels originally written to the most-significant bits of each byte as the word is read to the data outputs.

Parity bits for FIFO data are generated after the data is read from SRAM and before the data is written to the output register. The port-A parity-generate select (PGA) and odd/even parity select ($\text{ODD}/\overline{\text{EVEN}}$) have setup- and hold-time constraints to the port-A clock (CLKA) and the port-B parity generate select (PGB) and $\text{ODD}/\overline{\text{EVEN}}$ have setup- and hold-time constraints to the port-B clock (CLKB). These timing constraints apply only for a rising clock edge used to read a new long word to the FIFO output register.

The circuit used to generate parity for the mail1 data is shared by the port-B bus (B0–B35) to check parity. The circuit used to generate parity for the mail2 data is shared by the port-A bus (A0–A35) to check parity. The shared parity trees of a port are used to generate parity bits for the data in a mail register when the port chip select ($\overline{\text{CSA}}$, $\overline{\text{CSB}}$) is low, enable (ENA , ENB) is high, write/read select ($\text{W}/\overline{\text{RA}}$, $\text{W}/\overline{\text{RB}}$) input is low, the mail register is selected (MBA is high for port A; both SIZ0 and SIZ1 are high for port B), and port parity-generate select (PGA , PGB) is high. Generating parity for mail register data does not change the contents of the register.

64 × 36 × 2 CLOCKED BIDIRECTIONAL FIRST-IN, FIRST-OUT MEMORY WITH BUS MATCHING AND BYTE SWAPPING

SCBS126H – JUNE 1992 – REVISED APRIL 2000

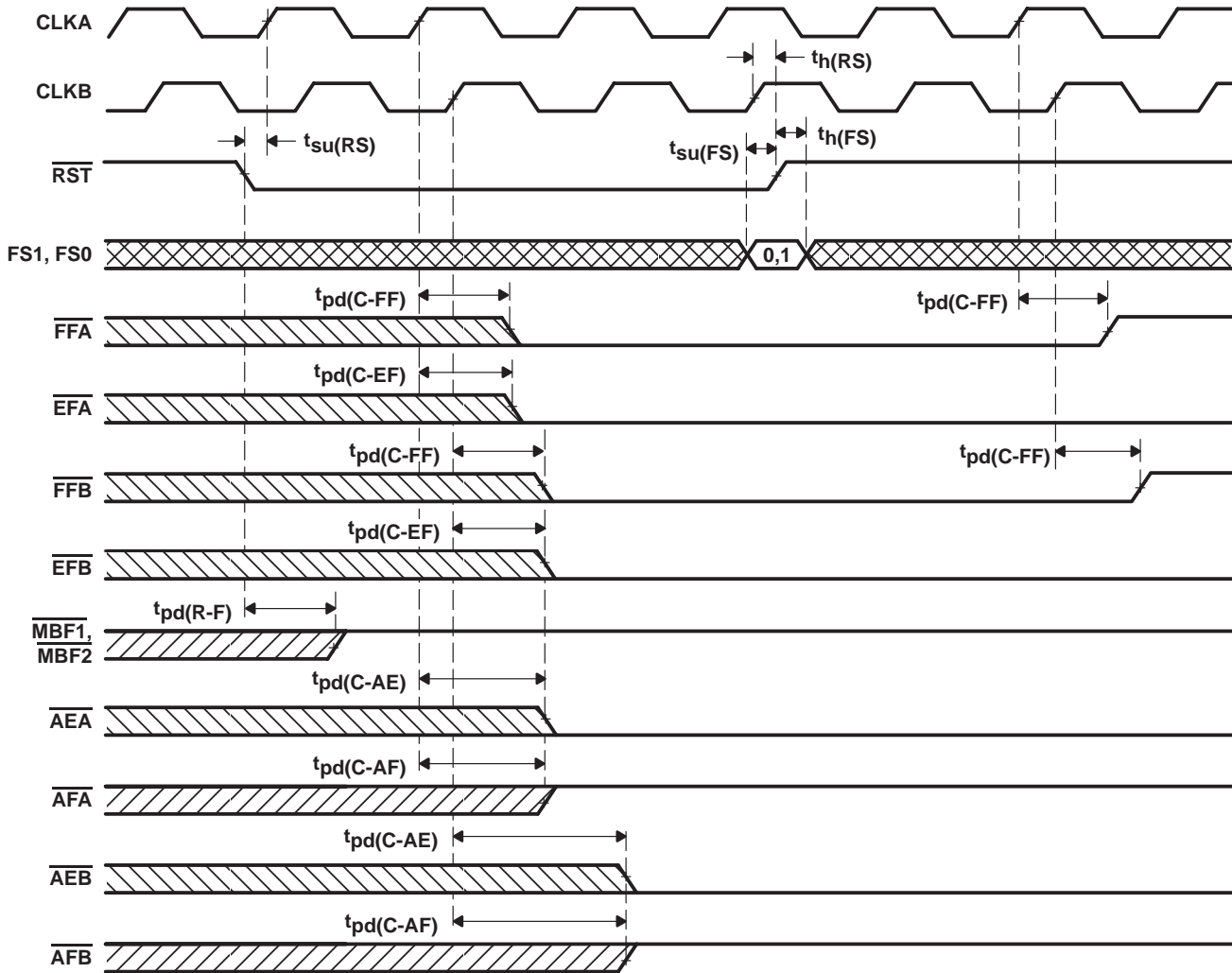
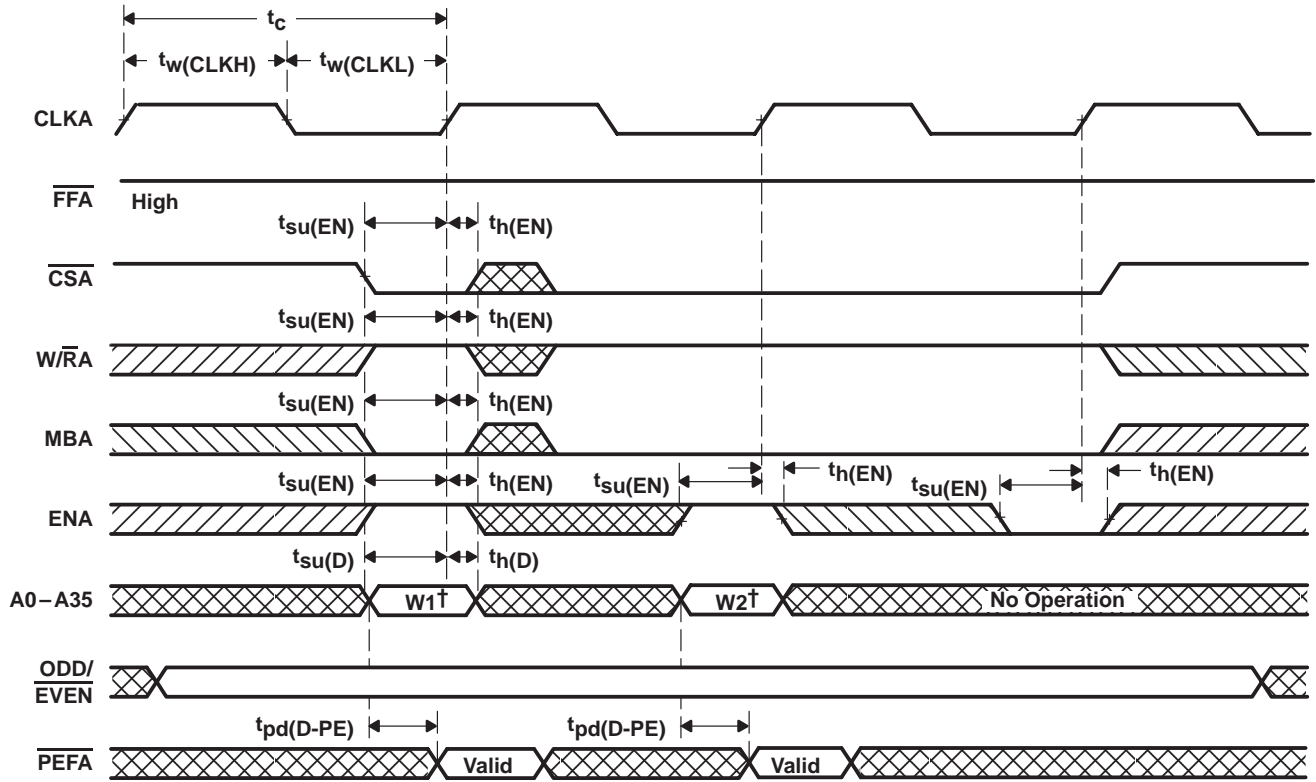

Figure 4. Device Reset Loading the X Register With the Value of Eight

SN74ABT3614
**64 × 36 × 2 CLOCKED BIDIRECTIONAL FIRST-IN, FIRST-OUT MEMORY
 WITH BUS MATCHING AND BYTE SWAPPING**

SCBS126H – JUNE 1992 – REVISED APRIL 2000



† Written to FIFO1

Figure 5. Port-A Write-Cycle Timing for FIFO1

64 × 36 × 2 CLOCKED BIDIRECTIONAL FIRST-IN, FIRST-OUT MEMORY WITH BUS MATCHING AND BYTE SWAPPING

SCBS126H – JUNE 1992 – REVISED APRIL 2000

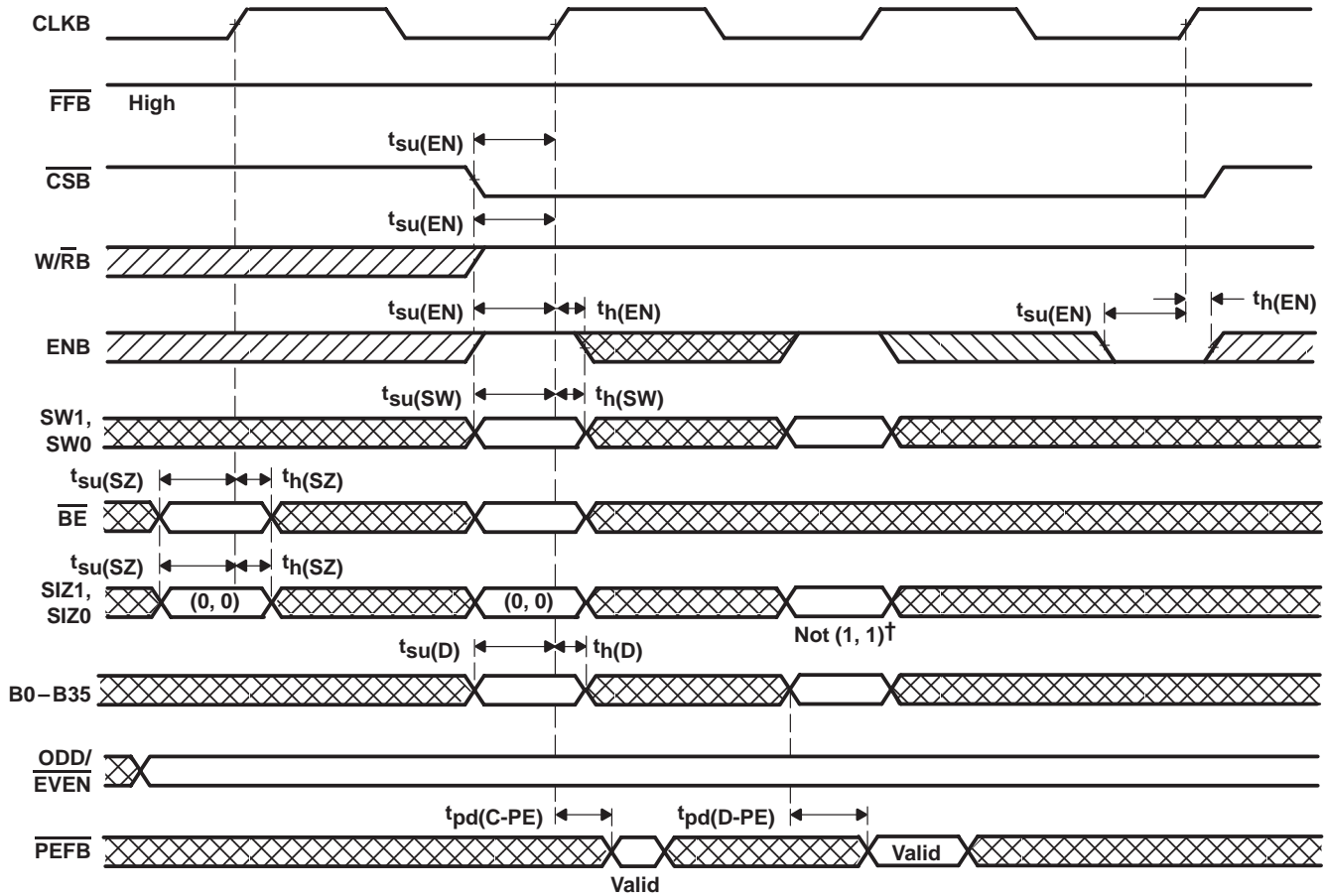

† SIZ0 = H and SIZ1 = H writes data to the mail2 register.

DATA SWAP TABLE FOR LONG-WORD WRITES TO FIFO2

SWAP MODE		DATA WRITTEN TO FIFO2				DATA READ FROM FIFO2			
SW1	SW0	B35-B27	B26-B18	B17-B9	B8-B0	A35-A27	A26-A18	A17-A9	A8-A0
L	L	A	B	C	D	A	B	C	D
L	H	D	C	B	A	A	B	C	D
H	L	C	D	A	B	A	B	C	D
H	H	B	A	D	C	A	B	C	D

Figure 6. Port-B Long-Word Write-Cycle Timing for FIFO2

SN74ABT3614
**64 × 36 × 2 CLOCKED BIDIRECTIONAL FIRST-IN, FIRST-OUT MEMORY
 WITH BUS MATCHING AND BYTE SWAPPING**

SCBS126H – JUNE 1992 – REVISED APRIL 2000

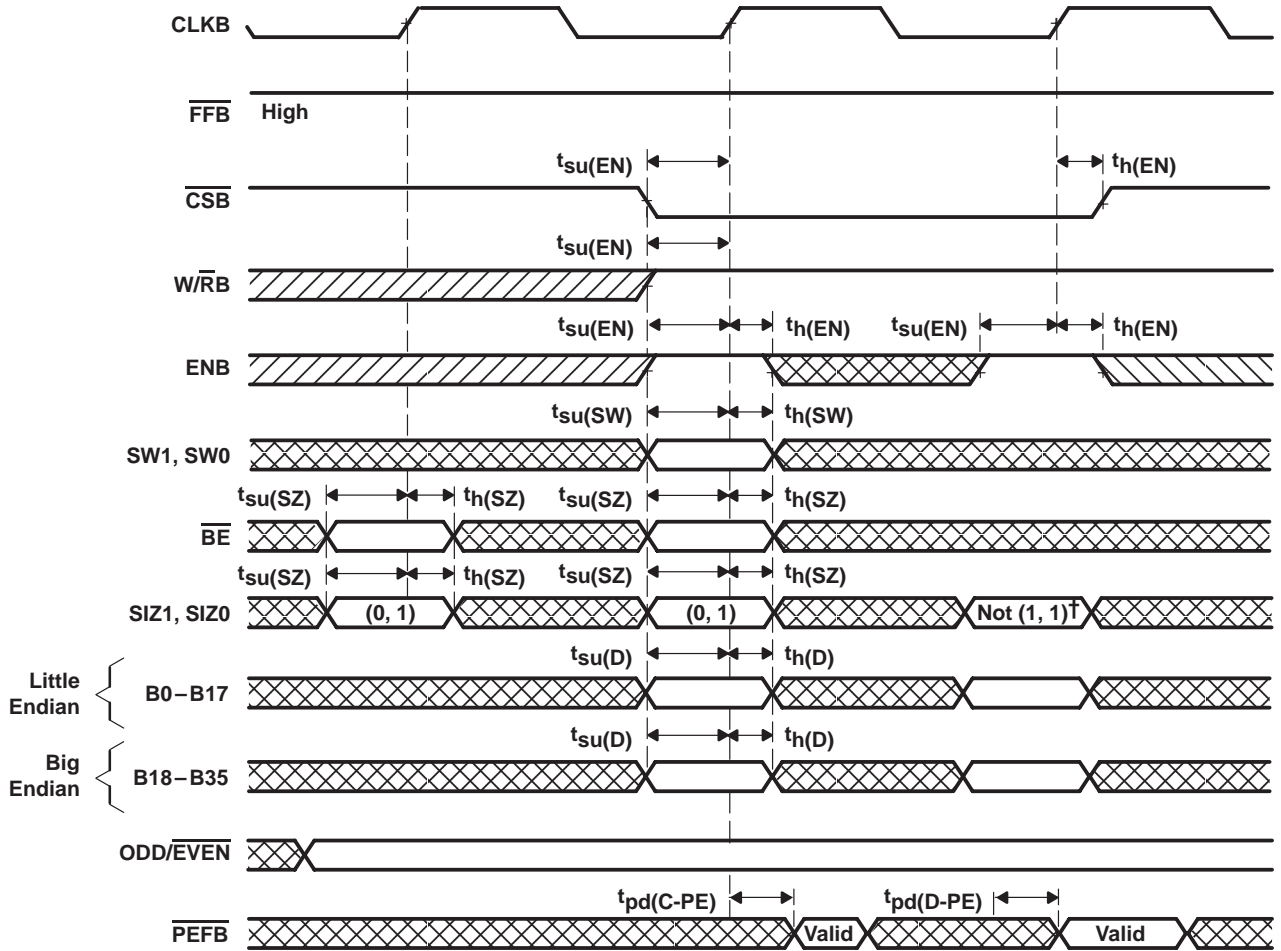

† SIZ0 = H and SIZ1 = H writes data to the mail2 register.

NOTE A: PEFB indicates parity error for the following bytes: B35–B27 and B26–B18 for big-endian bus, and B17–B9 and B8–B0 for little-endian bus.

DATA SWAP TABLE FOR WORD WRITES TO FIFO2

SWAP MODE		WRITE NO.	DATA WRITTEN TO FIFO2				DATA READ FROM FIFO2			
			BIG ENDIAN		LITTLE ENDIAN		A35–A27	A26–A18	A17–A9	A8–A0
SW1	SW0		B35–B27	B26–B18	B17–B9	B8–B0				
L	L	1	A	B	C	D	A	B	C	D
		2	C	D	A	B				
L	H	1	D	C	B	A	A	B	C	D
		2	B	A	D	C				
H	L	1	C	D	A	B	A	B	C	D
		2	A	B	C	D				
H	H	1	B	A	D	C	A	B	C	D
		2	D	C	B	A				

Figure 7. Port-B Word Write-Cycle Timing for FIFO2

64 × 36 × 2 CLOCKED BIDIRECTIONAL FIRST-IN, FIRST-OUT MEMORY WITH BUS MATCHING AND BYTE SWAPPING

SCBS126H – JUNE 1992 – REVISED APRIL 2000

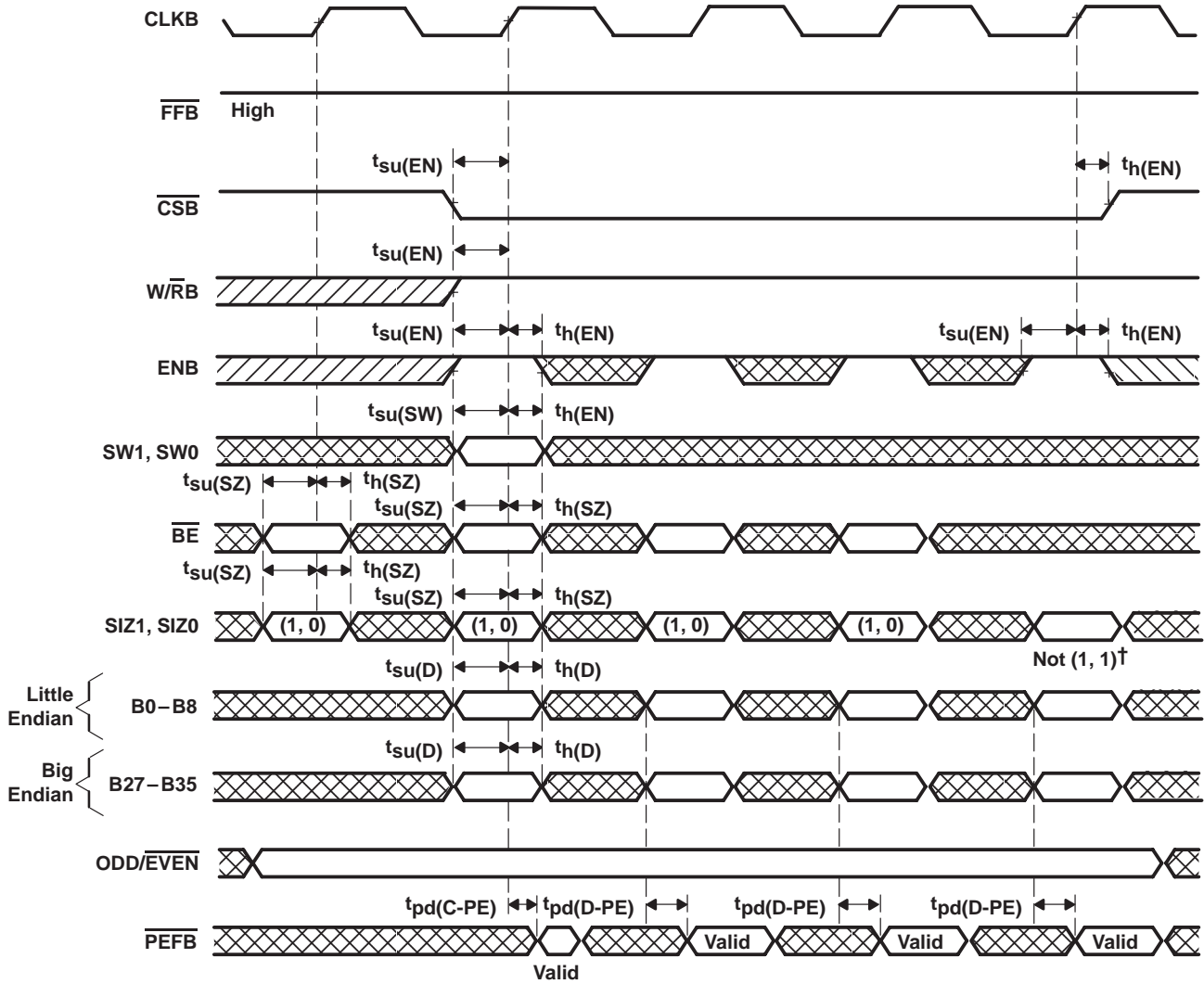

† SIZ0 = H and SIZ1 = H writes data to the mail2 register.

NOTE A: \overline{PEFB} indicates parity error for the following bytes: B35–B27 for big-endian bus and B17–B9 for little-endian bus.

Figure 8. Port-B Byte Write-Cycle Timing for FIFO2

SN74ABT3614

**64 × 36 × 2 CLOCKED BIDIRECTIONAL FIRST-IN, FIRST-OUT MEMORY
WITH BUS MATCHING AND BYTE SWAPPING**

SCBS126H – JUNE 1992 – REVISED APRIL 2000

DATA SWAP TABLE FOR BYTE WRITES TO FIFO2

SWAP MODE		WRITE NO.	DATA WRITTEN TO FIFO2		DATA READ FROM FIFO2			
			BIG ENDIAN	LITTLE ENDIAN				
SW1	SW0		B35–B27	B8–B0	A35–A27	A26–A18	A17–A9	A8–A0
L	L	1	A	D	A	B	C	D
		2	B	C				
		3	C	B				
		4	D	A				
L	H	1	D	A	A	B	C	D
		2	C	B				
		3	B	C				
		4	A	D				
H	L	1	C	B	A	B	C	D
		2	D	A				
		3	A	D				
		4	B	C				
H	H	1	B	C	A	B	C	D
		2	A	D				
		3	D	A				
		4	C	B				

Figure 8. Port-B Byte Write-Cycle Timing for FIFO2 (Continued)

SN74ABT3614

64 × 36 × 2 CLOCKED BIDIRECTIONAL FIRST-IN, FIRST-OUT MEMORY WITH BUS MATCHING AND BYTE SWAPPING

SCBS126H – JUNE 1992 – REVISED APRIL 2000

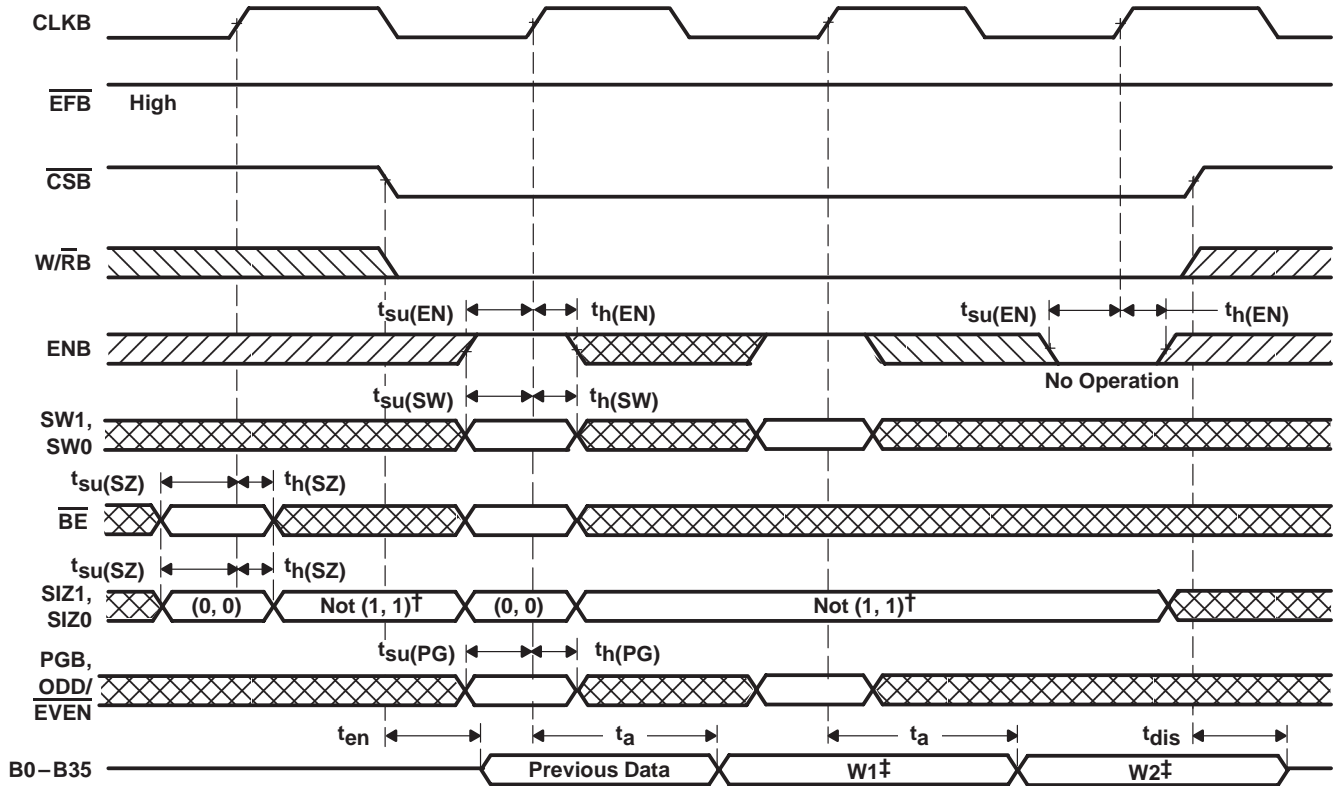

† SIZ0 = H and SIZ1 = H selects the mail1 register for output on B0–B35.

‡ Data read from FIFO1

DATA SWAP TABLE FOR LONG-WORD READS FROM FIFO1

DATA WRITTEN TO FIFO1				SWAP MODE		DATA READ FROM FIFO1			
A35–A27	A26–A18	A17–A9	A8–A0	SW1	SW0	B35–B27	B26–B18	B17–B9	B8–B0
A	B	C	D	L	L	A	B	C	D
A	B	C	D	L	H	D	C	B	A
A	B	C	D	H	L	C	D	A	B
A	B	C	D	H	H	B	A	D	C

Figure 9. Port-B Long-Word Read-Cycle Timing for FIFO1

SN74ABT3614
**64 × 36 × 2 CLOCKED BIDIRECTIONAL FIRST-IN, FIRST-OUT MEMORY
 WITH BUS MATCHING AND BYTE SWAPPING**

SCBS126H – JUNE 1992 – REVISED APRIL 2000

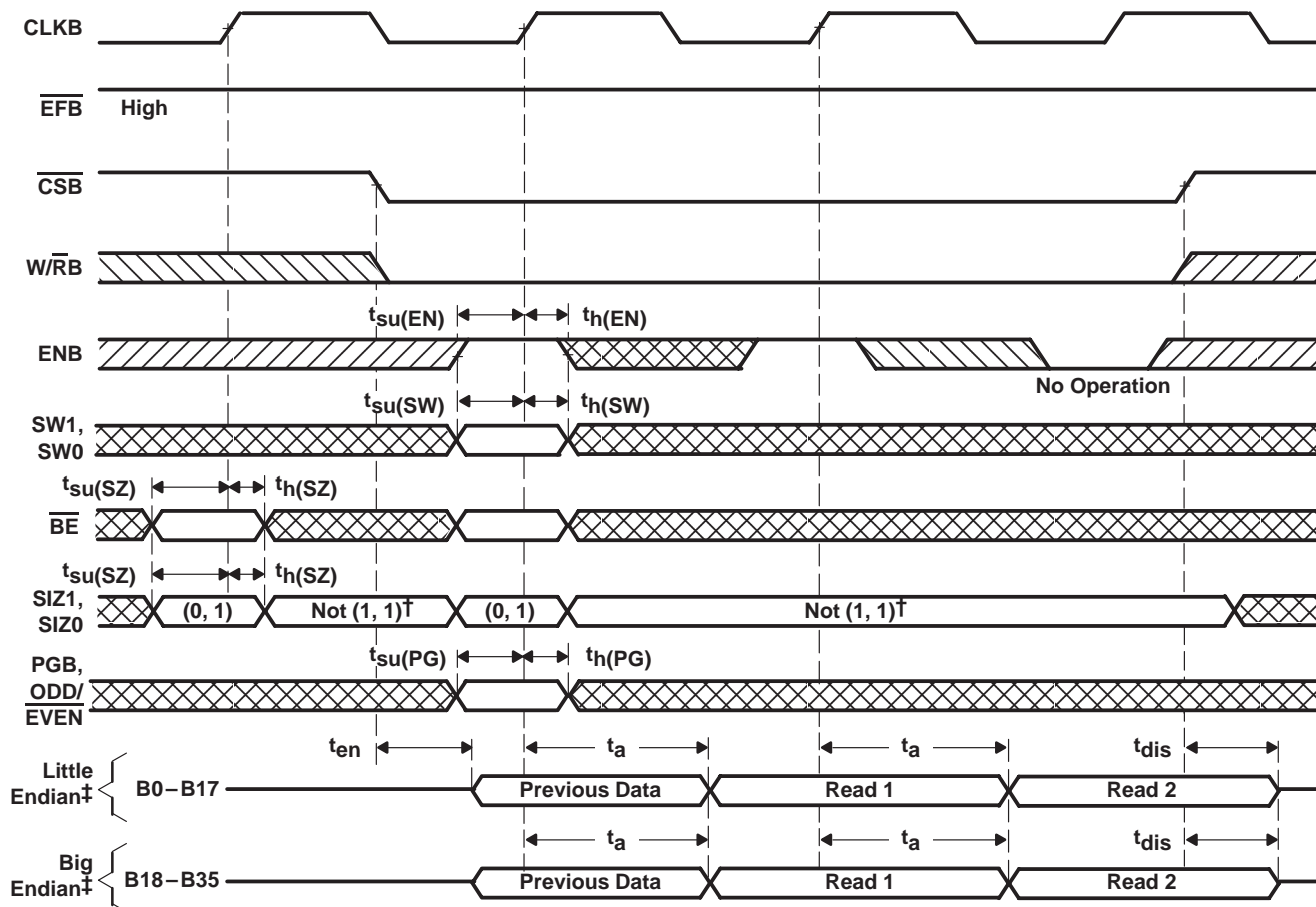

† SIZ0 = H and SIZ1 = H selects the mail1 register for output on B0–B35.

‡ Unused word B0–B17 or B18–B35 holds the last FIFO1-output-register data for word-size reads.

DATA SWAP TABLE FOR WORD READS FROM FIFO1

DATA WRITTEN TO FIFO1				SWAP MODE		READ NO.	DATA READ FROM FIFO1			
							BIG ENDIAN		LITTLE ENDIAN	
A35–A27	A26–A18	A17–A9	A8–A0	SW1	SW0		B35–B27	B26–B18	B17–B9	B8–B0
A	B	C	D	L	L	1	A	B	C	D
						2	C	D	A	B
A	B	C	D	L	H	1	D	C	B	A
						2	B	A	D	C
A	B	C	D	H	L	1	C	D	A	B
						2	A	B	C	D
A	B	C	D	H	H	1	B	A	D	C
						2	D	C	B	A

Figure 10. Port-B Word Read-Cycle Timing for FIFO1

64 × 36 × 2 CLOCKED BIDIRECTIONAL FIRST-IN, FIRST-OUT MEMORY WITH BUS MATCHING AND BYTE SWAPPING

SCBS126H – JUNE 1992 – REVISED APRIL 2000

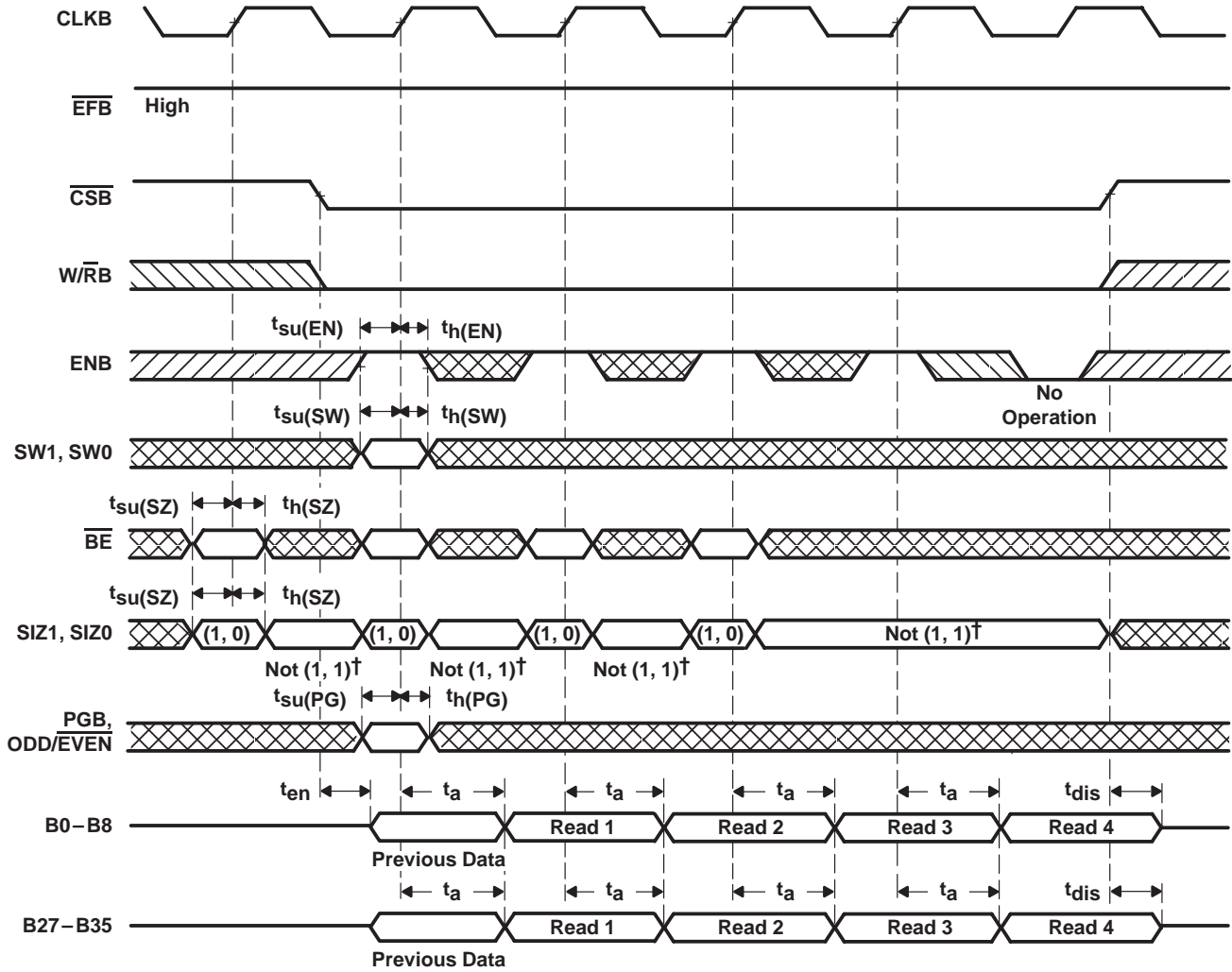

† SIZ0 = H and SIZ1 = H selects the mail1 register for output on B0–B35.

NOTE A: Unused bytes hold the last FIFO1-output-register data for byte-size reads.

Figure 11. Port-B Byte Read-Cycle Timing for FIFO1

SN74ABT3614

**64 × 36 × 2 CLOCKED BIDIRECTIONAL FIRST-IN, FIRST-OUT MEMORY
WITH BUS MATCHING AND BYTE SWAPPING**

SCBS126H – JUNE 1992 – REVISED APRIL 2000

DATA SWAP TABLE FOR BYTE READS FROM FIFO1

DATA WRITTEN TO FIFO1				SWAP MODE		READ NO.	DATA READ FROM FIFO1	
							BIG ENDIAN	LITTLE ENDIAN
A35–A27	A26–A18	A17–A9	A8–A0	SW1	SW0		B35–B27	B8–B0
A	B	C	D	L	L	1	A	D
						2	B	C
						3	C	B
						4	D	A
A	B	C	D	L	H	1	D	A
						2	C	B
						3	B	C
						4	A	D
A	B	C	D	H	L	1	C	B
						2	D	A
						3	A	D
						4	B	C
A	B	C	D	H	H	1	B	C
						2	A	D
						3	D	A
						4	C	B

Figure 11. Port-B Byte Read-Cycle Timing for FIFO1 (continued)

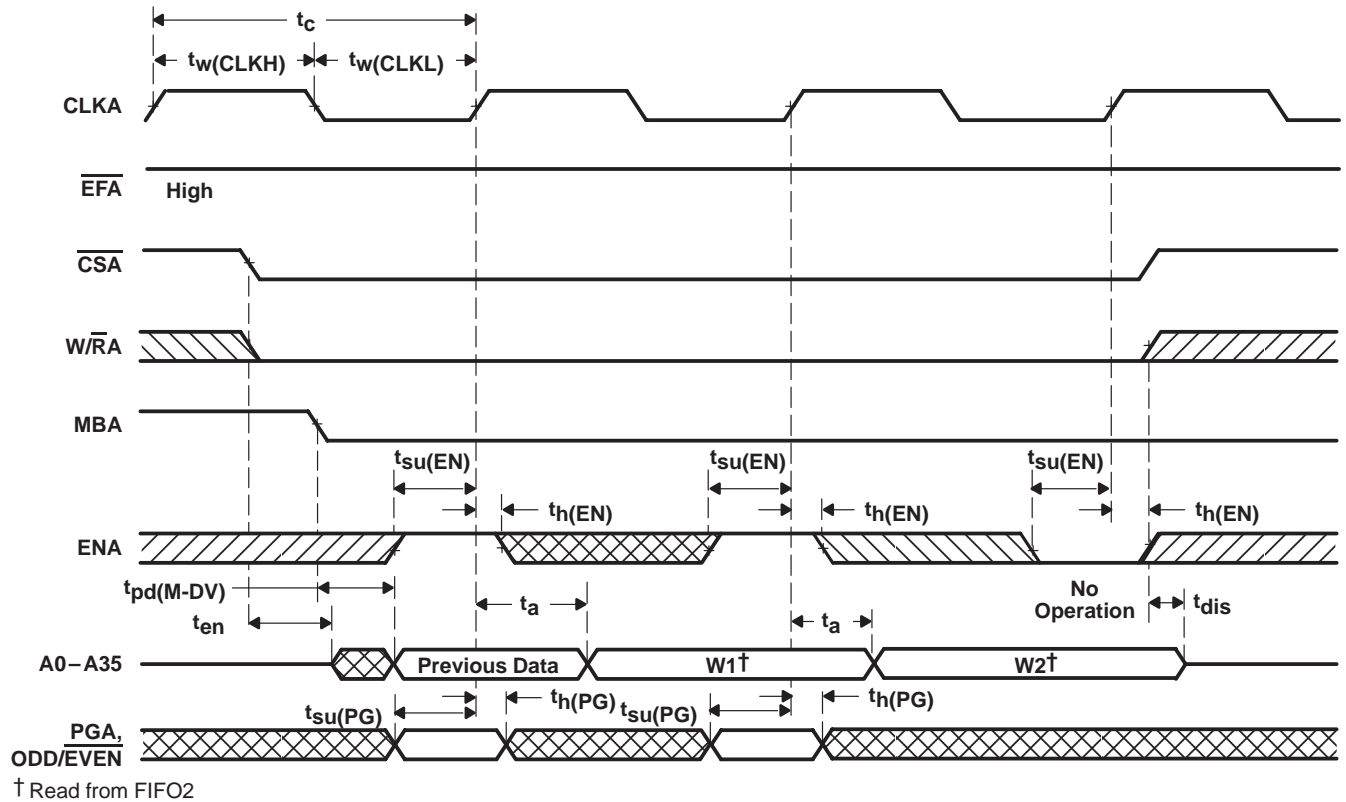
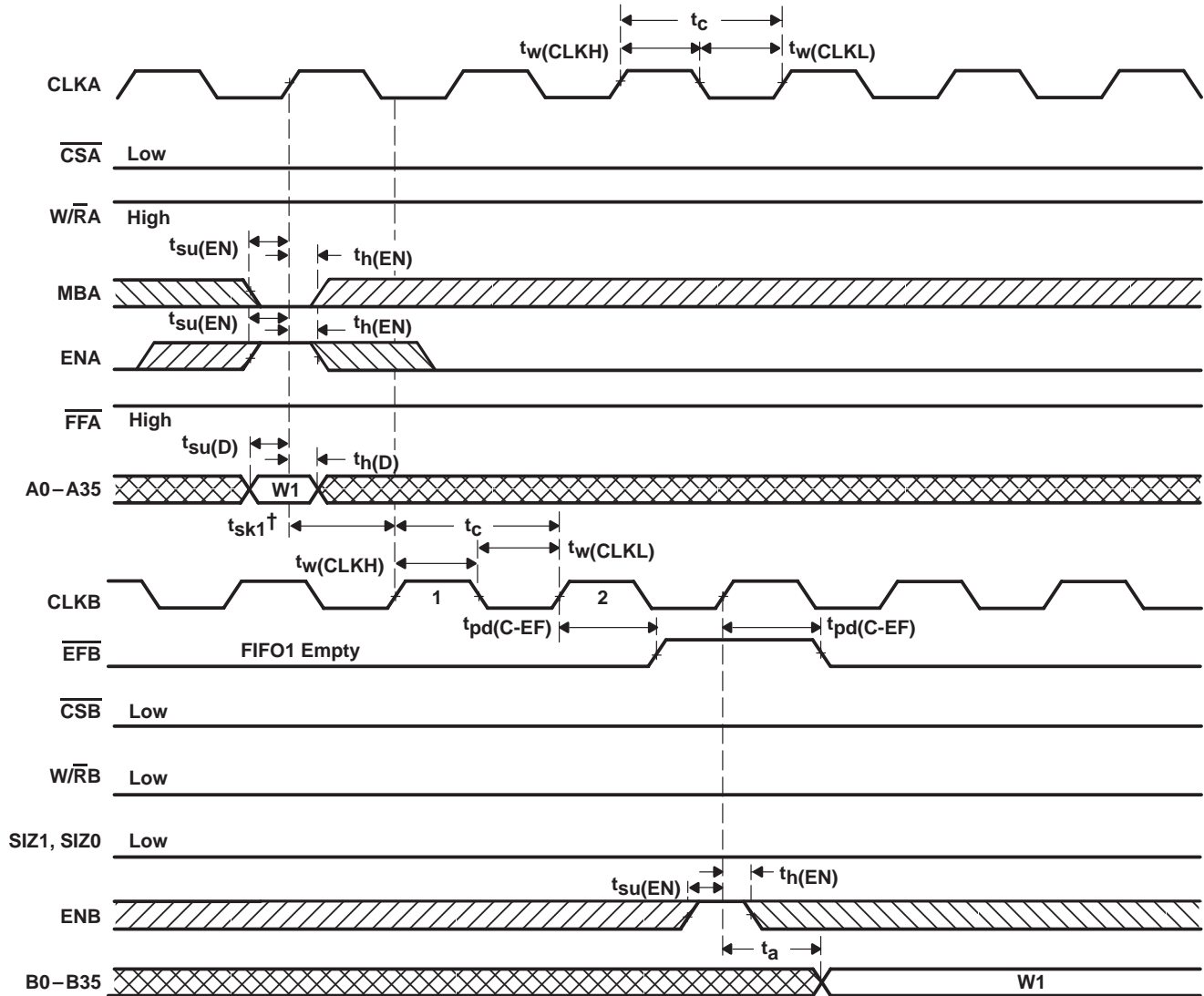

Figure 12. Port-A Read-Cycle Timing for FIFO2

64 × 36 × 2 CLOCKED BIDIRECTIONAL FIRST-IN, FIRST-OUT MEMORY WITH BUS MATCHING AND BYTE SWAPPING

SCBS126H – JUNE 1992 – REVISED APRIL 2000



$^\dagger t_{sk1}$ is the minimum time between a rising CLKA edge and a rising CLKB edge for \overline{EFB} to transition high in the next CLKB cycle. If the time between the rising CLKA edge and rising CLKB edge is less than t_{sk1} , the transition of \overline{EFB} high may occur one CLKB cycle later than shown.
 NOTE A: Port-B size of the long word is selected for FIFO1 read by $SIZ1 = L, SIZ0 = L$. If port-B size is word or byte, \overline{EFB} is set low by the last word or byte read from FIFO1, respectively.

Figure 13. \overline{EFB} -Flag Timing and First Data Read When FIFO1 Is Empty

SN74ABT3614
**64 × 36 × 2 CLOCKED BIDIRECTIONAL FIRST-IN, FIRST-OUT MEMORY
 WITH BUS MATCHING AND BYTE SWAPPING**

SCBS126H – JUNE 1992 – REVISED APRIL 2000

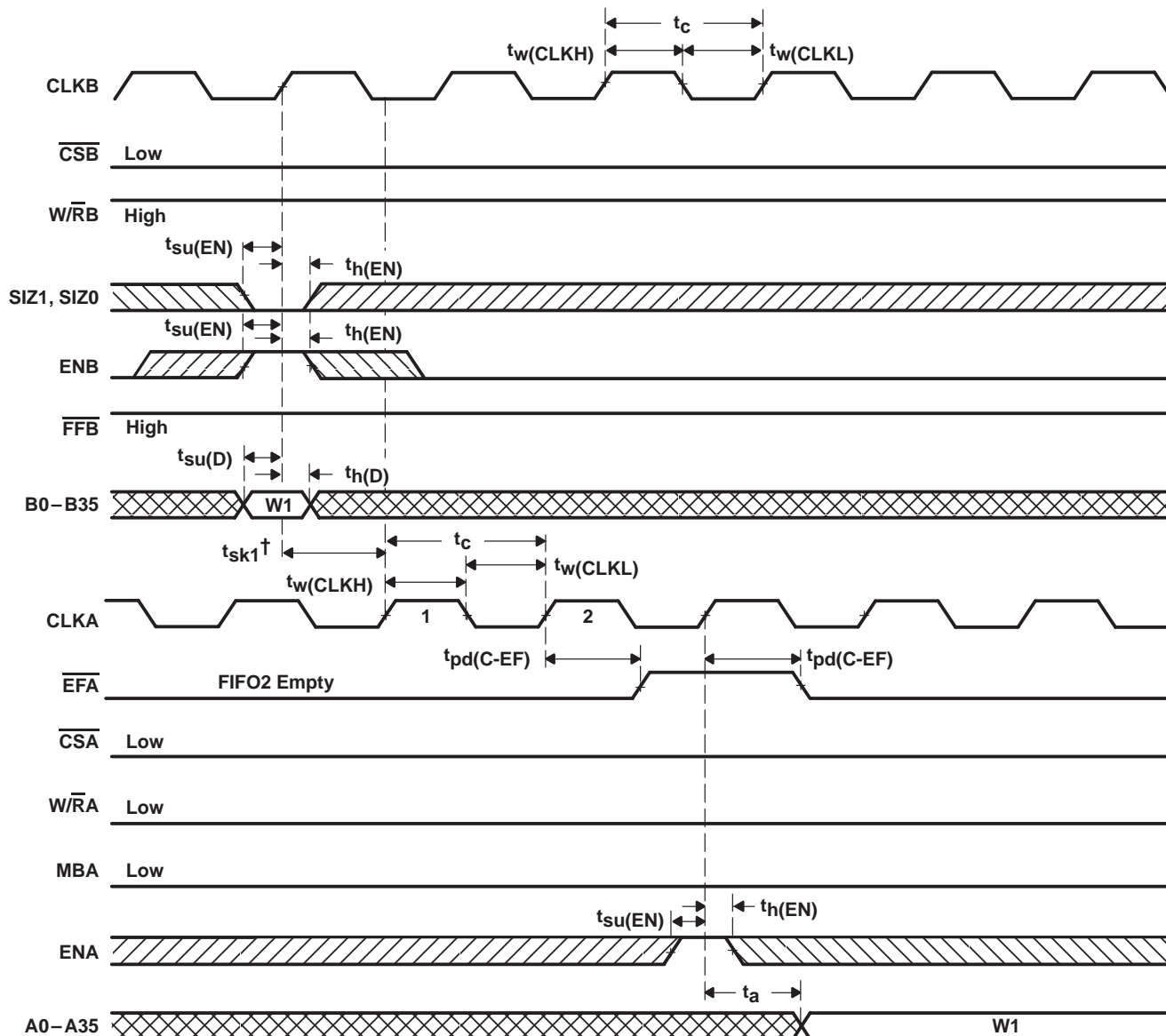

† t_{sk1} is the minimum time between a rising CLKB edge and a rising CLKA edge for \overline{EFA} to transition high in the next CLKA cycle. If the time between the rising CLKB edge and rising CLKA edge is less than t_{sk1} , the transition of \overline{EFA} high may occur one CLKA cycle later than shown.

NOTE A: Port-B size of the long word is selected for FIFO2 write by SIZ1 = L, SIZ0 = L. If port-B size is word or byte, t_{sk1} is referenced to the rising CLKB edge that writes the last word or byte of the long word, respectively.

Figure 14. \overline{EFA} -Flag Timing and First Data Read When FIFO2 Is Empty

64 × 36 × 2 CLOCKED BIDIRECTIONAL FIRST-IN, FIRST-OUT MEMORY WITH BUS MATCHING AND BYTE SWAPPING

SCBS126H – JUNE 1992 – REVISED APRIL 2000

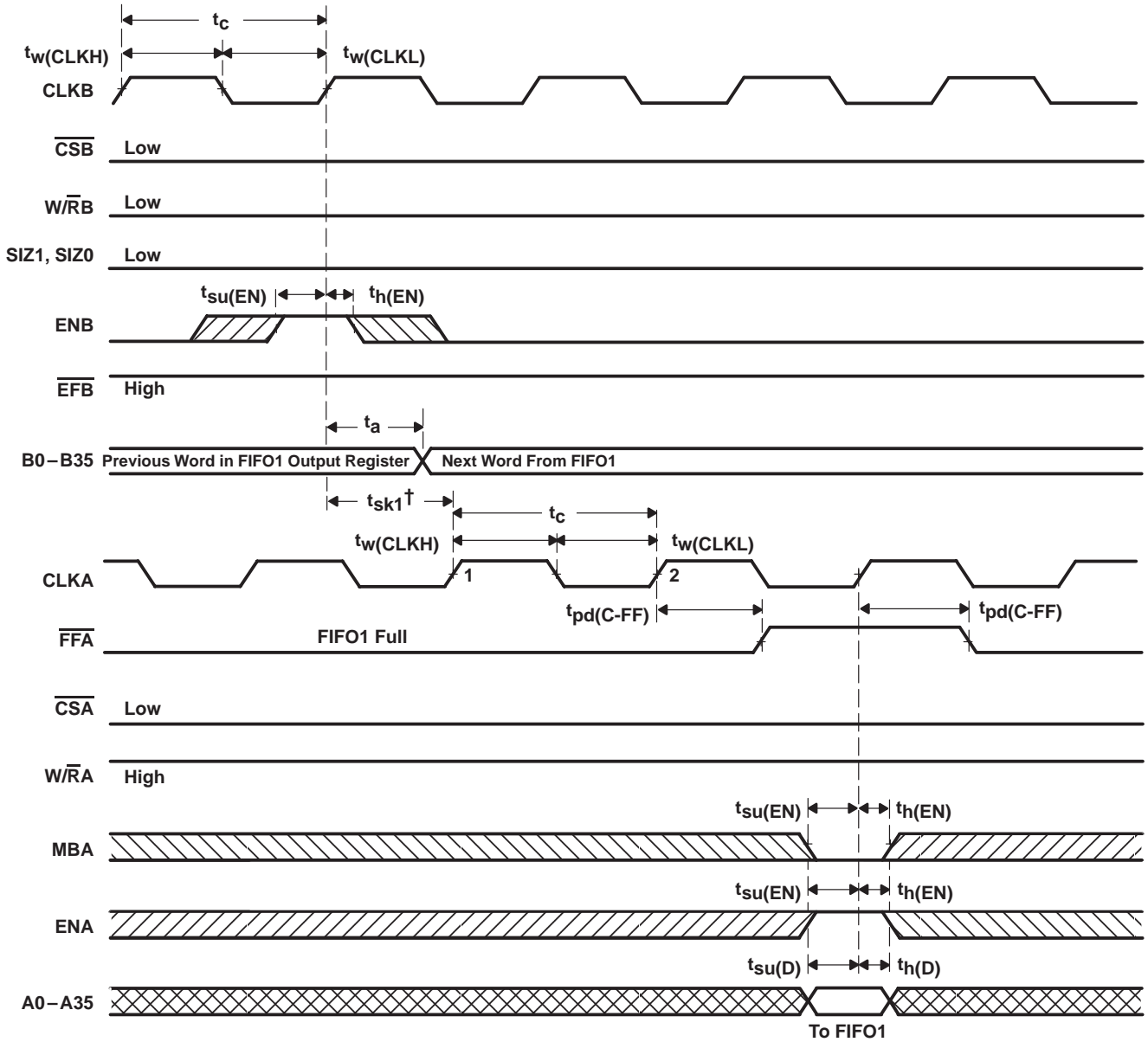

$^\dagger t_{sk1}$ is the minimum time between a rising CLKB edge and a rising CLKA edge for \overline{FFA} to transition high in the next CLKA cycle. If the time between the rising CLKB edge and rising CLKA edge is less than t_{sk1} , \overline{FFA} may transition high one CLKA cycle later than shown.

NOTE A: Port-B size of the long word is selected for the FIFO1 read by SIZ1 = L, SIZ0 = L. If port-B size is word or byte, t_{sk1} is referenced from the rising CLKB edge that reads the first word or byte of the long word, respectively.

Figure 15. \overline{FFA} -Flag Timing and First Available Write When FIFO1 Is Full

SN74ABT3614
**64 × 36 × 2 CLOCKED BIDIRECTIONAL FIRST-IN, FIRST-OUT MEMORY
 WITH BUS MATCHING AND BYTE SWAPPING**

SCBS126H – JUNE 1992 – REVISED APRIL 2000

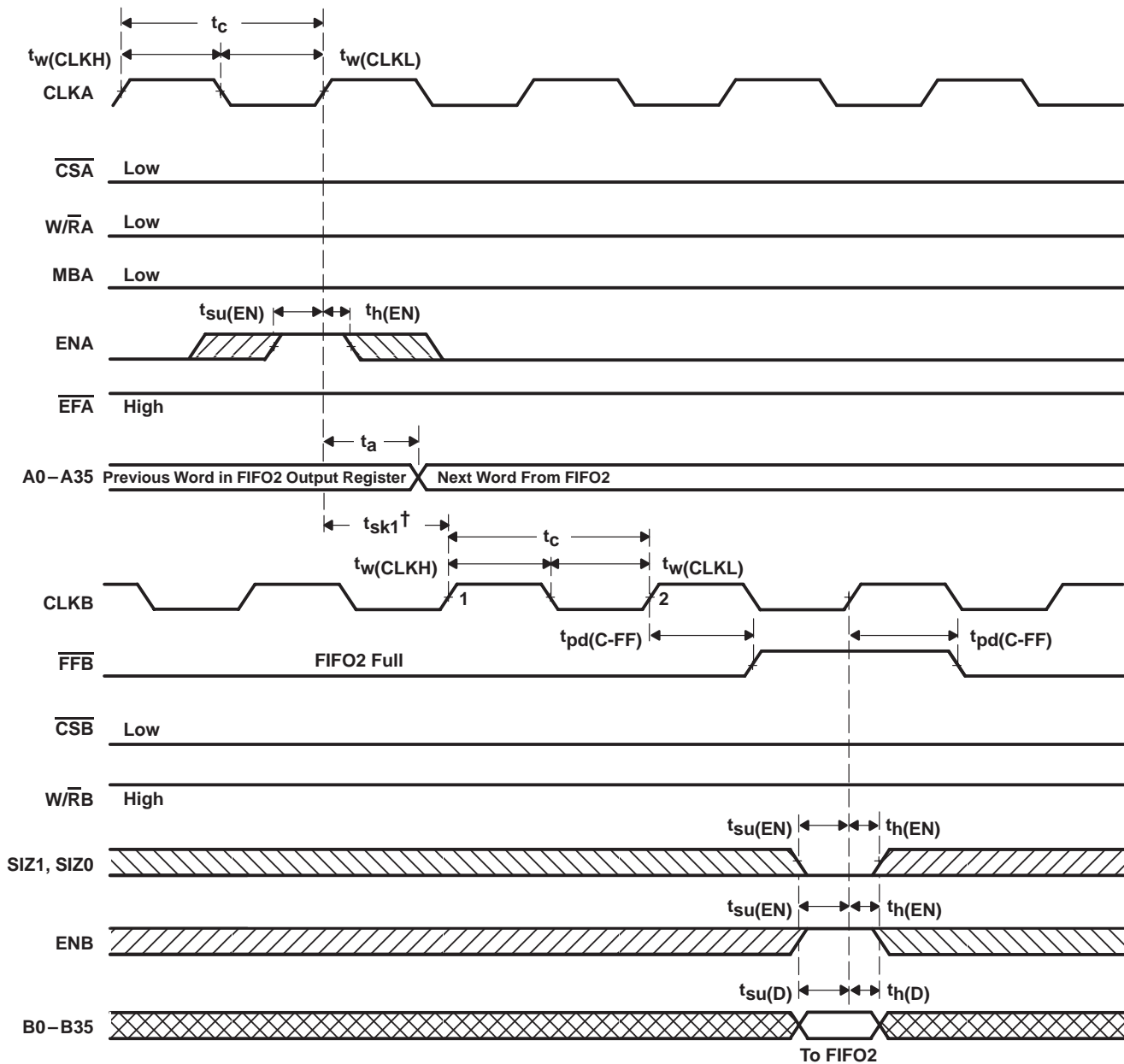

$^\dagger t_{sk1}$ is the minimum time between a rising CLKA edge and a rising CLKB edge for $\overline{\text{FFB}}$ to transition high in the next CLKB cycle. If the time between the rising CLKA edge and rising CLKB edge is less than t_{sk1} , $\overline{\text{FFB}}$ may transition high one CLKB cycle later than shown.

NOTE A: Port-B size of the long word is selected for FIFO2 write by SIZ1 = L, SIZ0 = L. If port-B size is word or byte, $\overline{\text{FFB}}$ is set low by the last word or byte write of the long word, respectively.

Figure 16. $\overline{\text{FFB}}$ -Flag Timing and First Available Write When FIFO2 Is Full

64 × 36 × 2 CLOCKED BIDIRECTIONAL FIRST-IN, FIRST-OUT MEMORY WITH BUS MATCHING AND BYTE SWAPPING

SCBS126H – JUNE 1992 – REVISED APRIL 2000

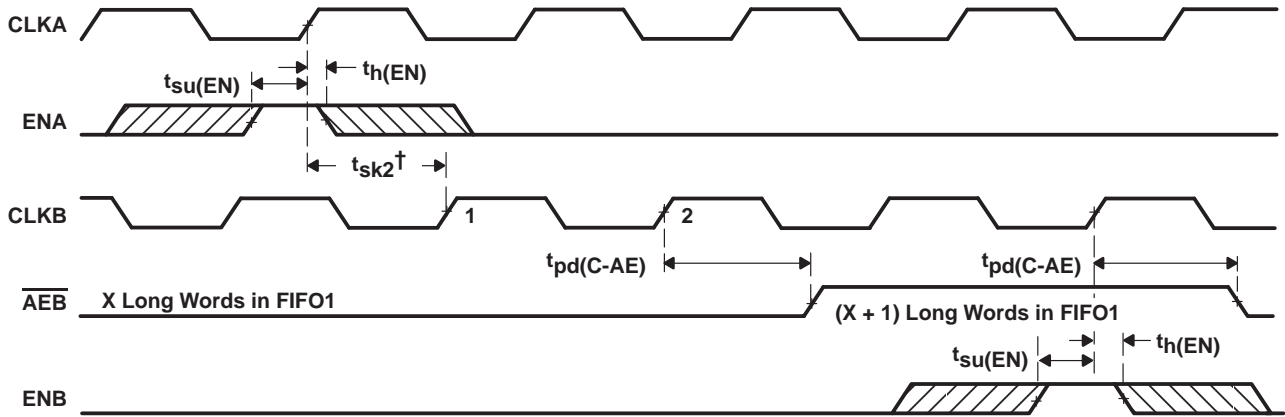

† t_{sk2} is the minimum time between a rising CLK_A edge and a rising CLK_B edge for \overline{AEB} to transition high in the next CLK_B cycle. If the time between the rising CLK_A edge and rising CLK_B edge is less than t_{sk2} , \overline{AEB} may transition high one CLK_B cycle later than shown.

- NOTES: A. FIFO1 write ($\overline{CSA} = L, W/\overline{RA} = H, MBA = L$), FIFO1 read ($\overline{CSB} = L, W/\overline{RB} = L, MBB = L$)
 B. Port-B size of the long word is selected for FIFO1 read by $SIZ1 = L, SIZ0 = L$. If port-B size is word or byte, \overline{AEB} is set low by the first word or byte read of the long word, respectively.

Figure 17. Timing for \overline{AEB} When FIFO1 Is Almost Empty

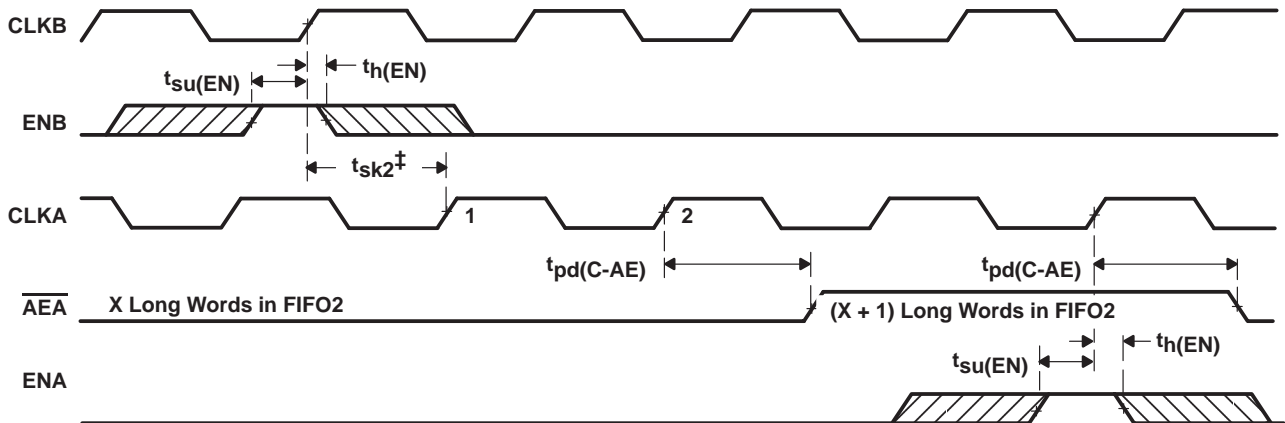

‡ t_{sk2} is the minimum time between a rising CLK_B edge and a rising CLK_A edge for \overline{AEA} to transition high in the next CLK_A cycle. If the time between the rising CLK_B edge and rising CLK_A edge is less than t_{sk2} , \overline{AEA} may transition high one CLK_A cycle later than shown.

- NOTES: A. FIFO2 write ($\overline{CSB} = L, W/\overline{RB} = H, MBB = L$), FIFO2 read ($\overline{CSA} = L, W/\overline{RA} = L, MBA = L$)
 B. Port-B size of the long word is selected for FIFO2 write by $SIZ1 = L, SIZ0 = L$. If port-B size is word or byte, t_{sk2} is referenced from the rising CLK_B edge that writes the last word or byte of the long word, respectively.

Figure 18. Timing for \overline{AEA} When FIFO2 Is Almost Empty

SN74ABT3614

**64 × 36 × 2 CLOCKED BIDIRECTIONAL FIRST-IN, FIRST-OUT MEMORY
WITH BUS MATCHING AND BYTE SWAPPING**

SCBS126H – JUNE 1992 – REVISED APRIL 2000

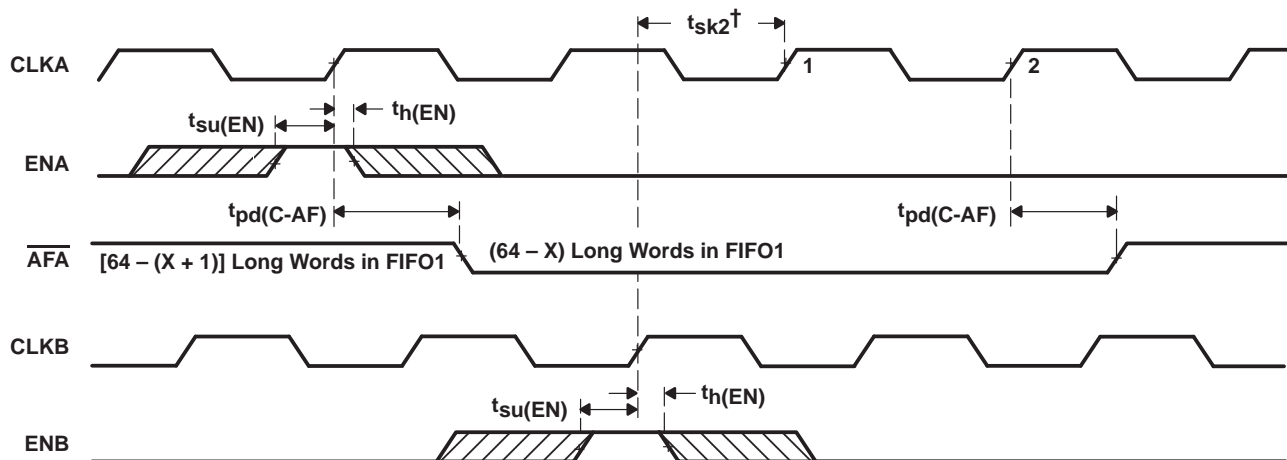

† t_{sk2} is the minimum time between a rising CLKA edge and a rising CLKB edge for \overline{AFA} to transition high in the next CLKA cycle. If the time between the rising CLKA edge and rising CLKB edge is less than t_{sk2} , \overline{AFA} may transition high one CLKB cycle later than shown.

- NOTES: A. FIFO1 write (CSA = L, W/RA = H, MBA = L), FIFO1 read (CSB = L, W/RB = L, MBB = L)
 B. Port-B size of the long word is selected for FIFO1 read by SIZ1 = L, SIZ0 = L. If port-B size is word or byte, t_{sk2} is referenced from the first word or byte read of the long word, respectively.

Figure 19. Timing for \overline{AFA} When FIFO1 Is Almost Full

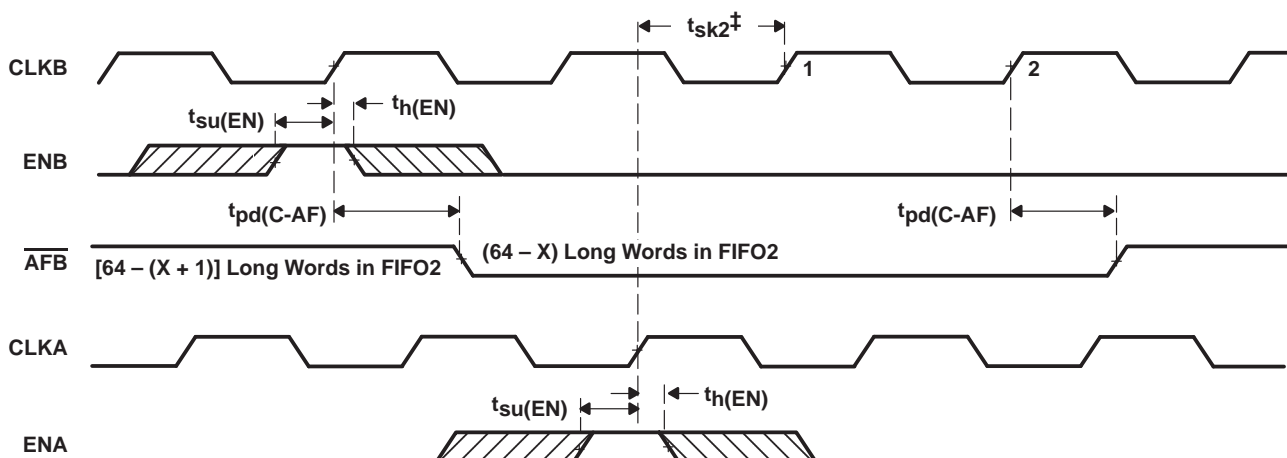

† t_{sk2} is the minimum time between a rising CLKB edge and a rising CLKA edge for \overline{AFB} to transition high in the next CLKB cycle. If the time between the rising CLKB edge and rising CLKA edge is less than t_{sk2} , \overline{AFB} may transition high one CLKA cycle later than shown.

- NOTES: A. FIFO2 write (CSB = L, W/RB = H, MBB = L), FIFO2 read (CSA = L, W/RA = L, MBA = L)
 B. Port-B size of the long word is selected for FIFO2 write by SIZ1 = L, SIZ0 = L. If port-B size is word or byte, \overline{AFB} is set low by the last word or byte write of the long word, respectively.

Figure 20. Timing for \overline{AFB} When FIFO2 Is Almost Full

64 × 36 × 2 CLOCKED BIDIRECTIONAL FIRST-IN, FIRST-OUT MEMORY WITH BUS MATCHING AND BYTE SWAPPING

SCBS126H – JUNE 1992 – REVISED APRIL 2000

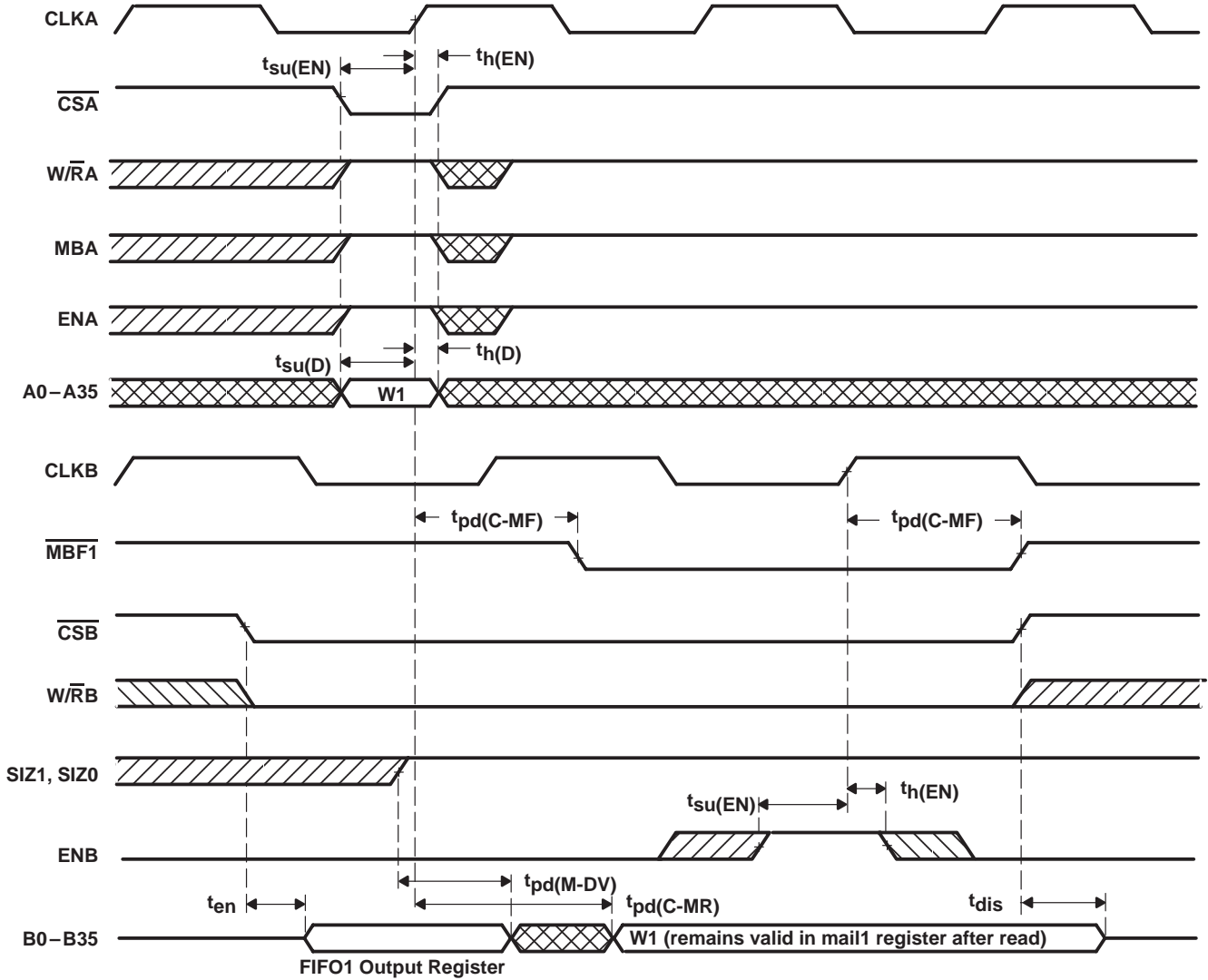

NOTE A: Port-B parity generation off (PGB = L)

Figure 21. Timing for Mail1 Register and $\overline{MBF1}$ Flag

SN74ABT3614
**64 × 36 × 2 CLOCKED BIDIRECTIONAL FIRST-IN, FIRST-OUT MEMORY
 WITH BUS MATCHING AND BYTE SWAPPING**

SCBS126H – JUNE 1992 – REVISED APRIL 2000

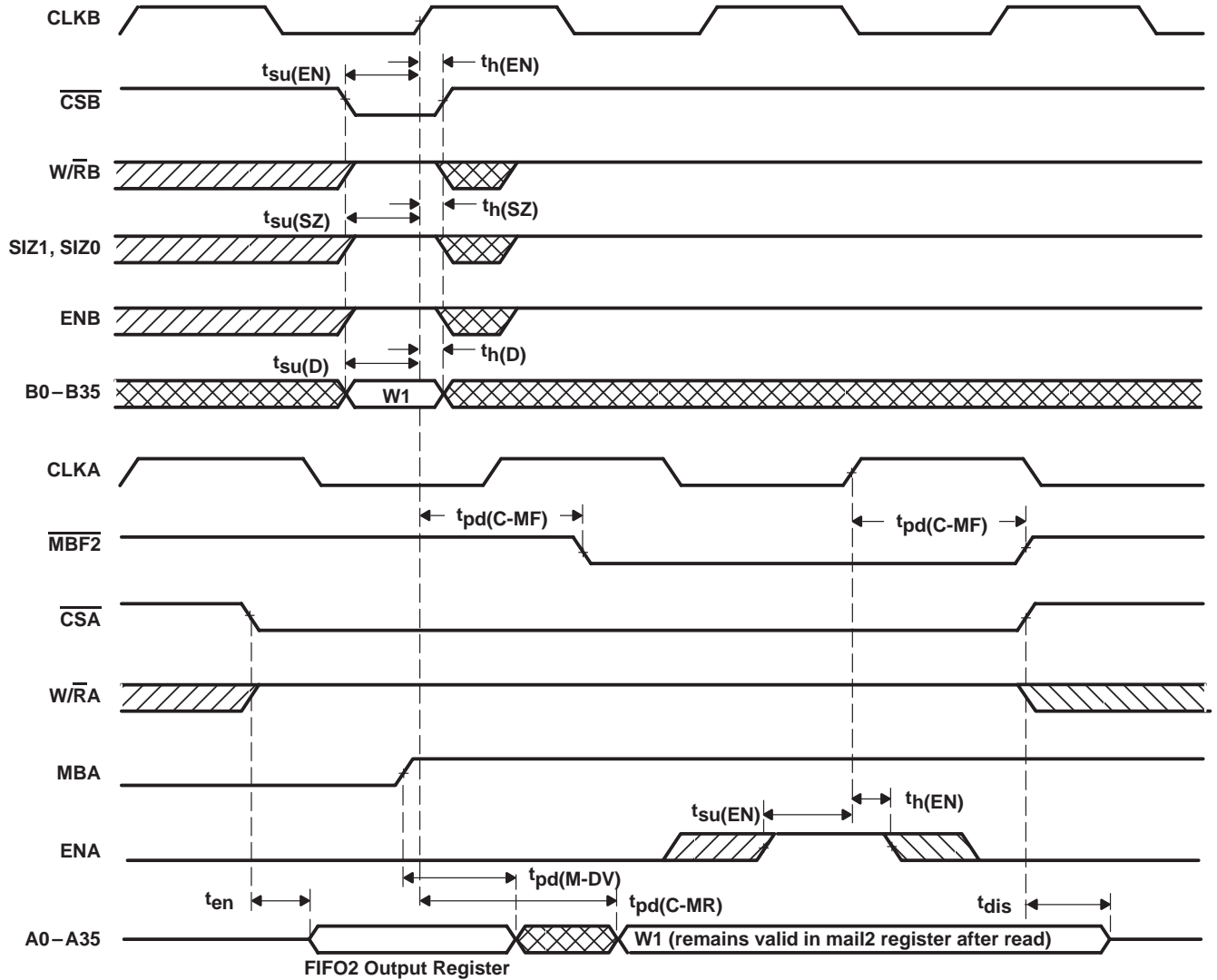

NOTE A: Port-A parity generation off (PGA = L)

Figure 22. Timing for Mail2 Register and $\overline{\text{MBF2}}$ Flag

64 × 36 × 2 CLOCKED BIDIRECTIONAL FIRST-IN, FIRST-OUT MEMORY WITH BUS MATCHING AND BYTE SWAPPING

SCBS126H – JUNE 1992 – REVISED APRIL 2000

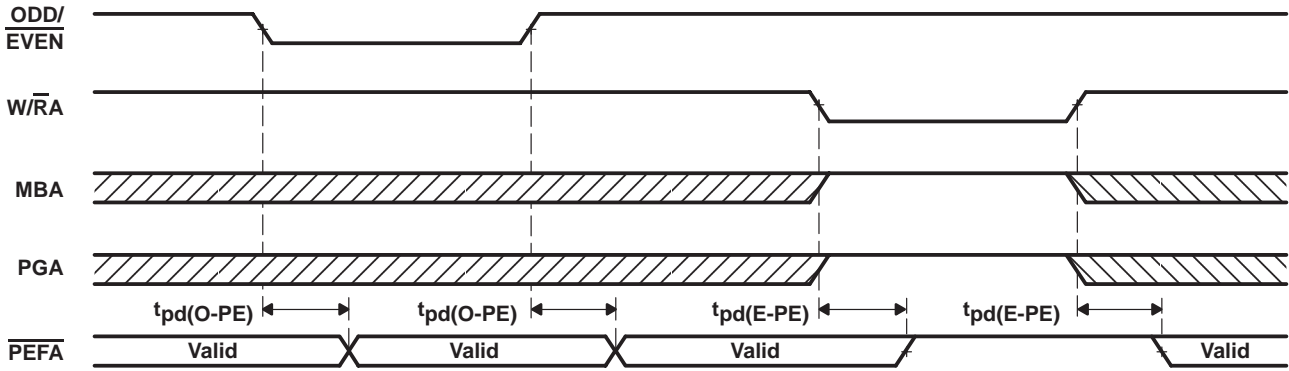

Figure 23. $\overline{ODD/EVEN}$, $\overline{W/RA}$, \overline{MBA} , and \overline{PGA} to \overline{PEFA} Timing

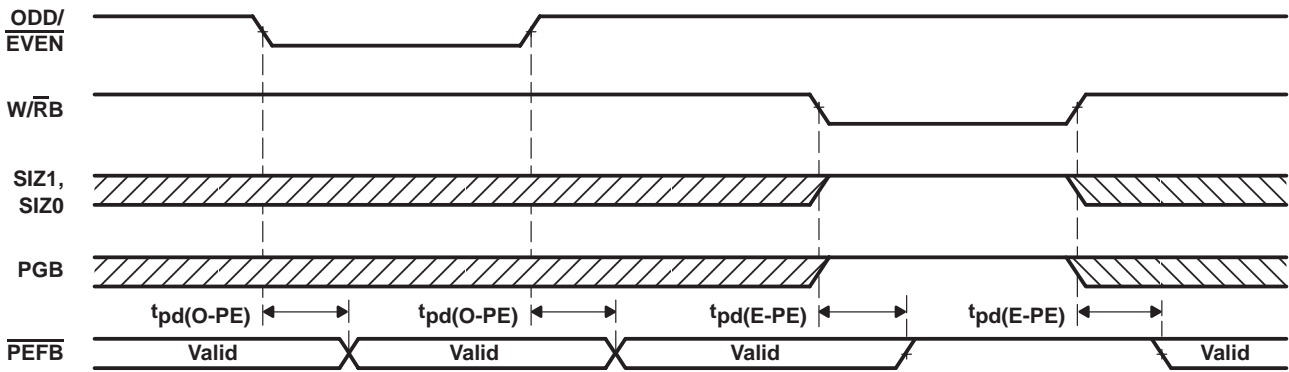

Figure 24. $\overline{ODD/EVEN}$, $\overline{W/RB}$, $\overline{SIZ1}$, $\overline{SIZ0}$, and \overline{PGB} to \overline{PEFB} Timing

SN74ABT3614
**64 × 36 × 2 CLOCKED BIDIRECTIONAL FIRST-IN, FIRST-OUT MEMORY
 WITH BUS MATCHING AND BYTE SWAPPING**

SCBS126H – JUNE 1992 – REVISED APRIL 2000

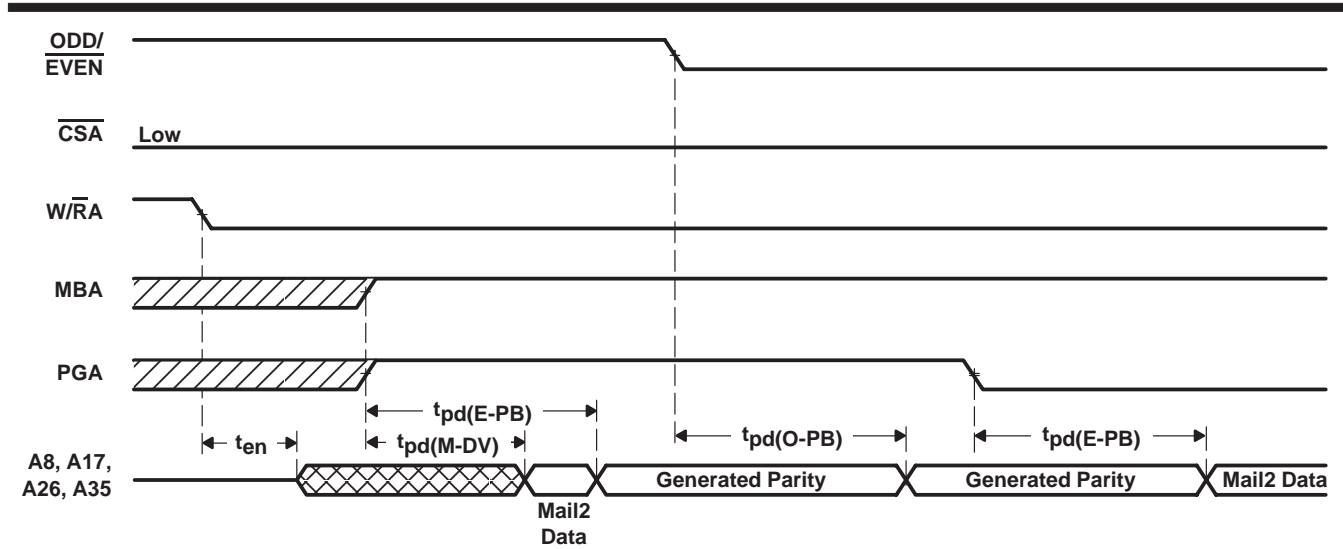

Figure 25. Parity-Generation Timing When Reading From the Mail2 Register

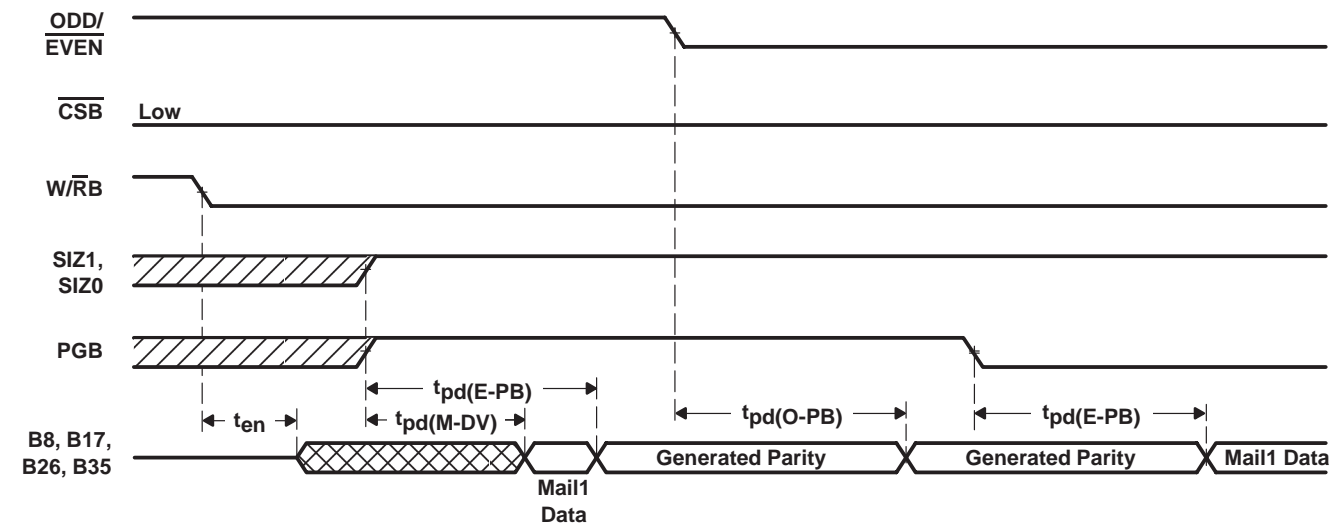

Figure 26. Parity-Generation Timing When Reading From the Mail1 Register

64 × 36 × 2 CLOCKED BIDIRECTIONAL FIRST-IN, FIRST-OUT MEMORY WITH BUS MATCHING AND BYTE SWAPPING

SCBS126H – JUNE 1992 – REVISED APRIL 2000

absolute maximum ratings over operating free-air temperature range (unless otherwise noted)†

Supply voltage range, V_{CC}	-0.5 V to 7 V
Input voltage range, V_I (see Note 1)	-0.5 V to $V_{CC} + 0.5$ V
Output voltage range, V_O (see Note 1)	-0.5 V to $V_{CC} + 0.5$ V
Input clamp current, I_{IK} ($V_I < 0$ or $V_I > V_{CC}$)	±20 mA
Output clamp current, I_{OK} ($V_O < 0$ or $V_O > V_{CC}$)	±50 mA
Continuous output current, I_O ($V_O = 0$ to V_{CC})	±50 mA
Continuous current through V_{CC} or GND	±500 mA
Package thermal impedance, θ_{JA} (see Note 2): PCB package	28°C/W
PQ package	46°C/W
Storage temperature range, T_{stg}	-65°C to 150°C

† Stresses beyond those listed under “absolute maximum ratings” may cause permanent damage to the device. These are stress ratings only, and functional operation of the device at these or any other conditions beyond those indicated under “recommended operating conditions” is not implied. Exposure to absolute-maximum-rated conditions for extended periods may affect device reliability.

- NOTES: 1. The input and output voltage ratings may be exceeded provided the input and output current ratings are observed.
 2. The package thermal impedance is calculated in accordance with JESD 51.

recommended operating conditions

	MIN	MAX	UNIT
V_{CC} Supply voltage	4.5	5.5	V
V_{IH} High-level input voltage	2		V
V_{IL} Low-level input voltage		0.8	V
I_{OH} High-level output current		-4	mA
I_{OL} Low-level output current		8	mA
T_A Operating free-air temperature	0	70	°C

electrical characteristics over recommended operating free-air temperature range (unless otherwise noted)

PARAMETER	TEST CONDITIONS	MIN	TYP‡	MAX	UNIT
V_{OH}	$V_{CC} = 4.5$ V, $I_{OH} = -4$ mA	2.4			V
V_{OL}	$V_{CC} = 4.5$ V, $I_{OL} = 8$ mA			0.5	V
I_I	$V_{CC} = 5.5$ V, $V_I = V_{CC}$ or 0			±50	µA
I_{OZ}	$V_{CC} = 5.5$ V, $V_O = V_{CC}$ or 0			±50	µA
I_{CC}	$V_{CC} = 5.5$ V, $I_O = 0$ mA, $V_I = V_{CC}$ or GND	Outputs high		30	mA
		Outputs low		130	
		Outputs disabled		30	
C_i	$V_I = 0$, $f = 1$ MHz		4		pF
C_o	$V_O = 0$, $f = 1$ MHz		8		pF

‡ All typical values are at $V_{CC} = 5$ V, $T_A = 25^\circ\text{C}$.



SN74ABT3614
**64 × 36 × 2 CLOCKED BIDIRECTIONAL FIRST-IN, FIRST-OUT MEMORY
 WITH BUS MATCHING AND BYTE SWAPPING**

SCBS126H – JUNE 1992 – REVISED APRIL 2000

timing requirements over recommended ranges of supply voltage and operating free-air temperature (see Figures 4 through 27)

		'ABT3614-15		'ABT3614-20		'ABT3614-30		UNIT
		MIN	MAX	MIN	MAX	MIN	MAX	
f_{clock}	Clock frequency, CLKA or CLKB	66.7		50		33.4		MHz
t_c	Clock cycle time, CLKA or CLKB	15		20		30		ns
$t_w(\text{CLKH})$	Pulse duration, CLKA and CLKB high	6		8		12		ns
$t_w(\text{CLKL})$	Pulse duration, CLKA and CLKB low	6		8		12		ns
$t_{\text{su}}(\text{D})$	Setup time, A0–A35 before CLKA \uparrow and B0–B35 before CLKB \uparrow	4		5		6		ns
$t_{\text{su}}(\text{EN})$	Setup time, $\overline{\text{CSA}}$, W/ $\overline{\text{RA}}$, ENA, and MBA before CLKA \uparrow ; $\overline{\text{CSB}}$, W/ $\overline{\text{RB}}$, and ENB before CLKB \uparrow	5		5		6		ns
$t_{\text{su}}(\text{SZ})$	Setup time, SIZ0, SIZ1, and $\overline{\text{BE}}$ before CLKB \uparrow	4		5		6		ns
$t_{\text{su}}(\text{SW})$	Setup time, SW0 and SW1 before CLKB \uparrow	5		7		8		ns
$t_{\text{su}}(\text{PG})$	Setup time, ODD/ $\overline{\text{EVEN}}$ and PGA before CLKA \uparrow ; ODD/ $\overline{\text{EVEN}}$ and PGB before CLKB \uparrow	4		5		6		ns
$t_{\text{su}}(\text{RS})$	Setup time, $\overline{\text{RST}}$ low before CLKA \uparrow or CLKB \uparrow ‡	5		6		7		ns
$t_{\text{su}}(\text{FS})$	Setup time, FS0 and FS1 before $\overline{\text{RST}}$ high	5		6		7		ns
$t_{\text{h}}(\text{D})$	Hold time, A0–A35 after CLKA \uparrow and B0–B35 after CLKB \uparrow	1		1		1		ns
$t_{\text{h}}(\text{EN})$	Hold time, $\overline{\text{CSA}}$, W/ $\overline{\text{RA}}$, ENA, and MBA after CLKA \uparrow ; $\overline{\text{CSB}}$, W/ $\overline{\text{RB}}$, and ENB after CLKB \uparrow	1		1		1		ns
$t_{\text{h}}(\text{SZ})$	Hold time, SIZ0, SIZ1, and $\overline{\text{BE}}$ after CLKB \uparrow	2		2		2		ns
$t_{\text{h}}(\text{SW})$	Hold time, SW0 and SW1 after CLKB \uparrow	0		0		0		ns
$t_{\text{h}}(\text{PG})$	Hold time, ODD/ $\overline{\text{EVEN}}$ and PGA after CLKA \uparrow ; ODD/ $\overline{\text{EVEN}}$ and PGB after CLKB \uparrow	0		0		0		ns
$t_{\text{h}}(\text{RS})$	Hold time, $\overline{\text{RST}}$ low after CLKA \uparrow or CLKB \uparrow ‡	5		6		7		ns
$t_{\text{h}}(\text{FS})$	Hold time, FS0 and FS1 after $\overline{\text{RST}}$ high	4		4		4		ns
$t_{\text{sk}1}^{\text{§}}$	Skew time between CLKA \uparrow and CLKB \uparrow for $\overline{\text{EFA}}$, $\overline{\text{EFB}}$, $\overline{\text{FFA}}$, and $\overline{\text{FFB}}$	8		8		10		ns
$t_{\text{sk}2}^{\text{§}}$	Skew time between CLKA \uparrow and CLKB \uparrow for $\overline{\text{AEA}}$, $\overline{\text{AEB}}$, $\overline{\text{AFA}}$, and $\overline{\text{AFB}}$	9		16		20		ns

† Applies only for a clock edge that does a FIFO read

‡ Requirement to count the clock edge as one of at least four needed to reset a FIFO

§ Skew time is not a timing constraint for proper device operation and is included only to illustrate the timing relationship between CLKA cycle and CLKB cycle.

SN74ABT3614

64 × 36 × 2 CLOCKED BIDIRECTIONAL FIRST-IN, FIRST-OUT MEMORY WITH BUS MATCHING AND BYTE SWAPPING

SCBS126H – JUNE 1992 – REVISED APRIL 2000

switching characteristics over recommended ranges of supply voltage and operating free-air temperature, $C_L = 30$ pF (see Figures 4 through 27)

PARAMETER	'ABT3614-15		'ABT3614-20		'ABT3614-30		UNIT
	MIN	MAX	MIN	MAX	MIN	MAX	
f_{max}	66.7		50		33.4		MHz
t_a Access time, $CLKA \uparrow$ to $A0-A35$ and $CLKB \uparrow$ to $B0-B35$	2	10	2	12	2	15	ns
$t_{pd}(C-FF)$ Propagation delay time, $CLKA \uparrow$ to \overline{FFA} and $CLKB \uparrow$ to \overline{FFB}	2	10	2	12	2	15	ns
$t_{pd}(C-EF)$ Propagation delay time, $CLKA \uparrow$ to \overline{EFA} and $CLKB \uparrow$ to \overline{EFB}	2	10	2	12	2	15	ns
$t_{pd}(C-AE)$ Propagation delay time, $CLKA \uparrow$ to \overline{AEA} and $CLKB \uparrow$ to \overline{AEB}	2	10	2	12	2	15	ns
$t_{pd}(C-AF)$ Propagation delay time, $CLKA \uparrow$ to \overline{AFA} and $CLKB \uparrow$ to \overline{AFB}	2	10	2	12	2	15	ns
$t_{pd}(C-MF)$ Propagation delay time, $CLKA \uparrow$ to $\overline{MBF1}$ low or $\overline{MBF2}$ high and $CLKB \uparrow$ to $\overline{MBF2}$ low or $\overline{MBF1}$ high	1	9	1	12	1	15	ns
$t_{pd}(C-MR)$ Propagation delay time, $CLKA \uparrow$ to $B0-B35 \dagger$ and $CLKB \uparrow$ to $A0-A35 \ddagger$	3	11	3	13	3	15	ns
$t_{pd}(C-PE) \S$ Propagation delay time, $CLKB \uparrow$ to \overline{PEFB}	2	11	2	12	2	13	ns
$t_{pd}(M-DV)$ Propagation delay time, MBA to $A0-A35$ valid and $SIZ1, SIZ0$ to $B0-B35$ valid	1	11	1	11.5	1	12	ns
$t_{pd}(D-PE)$ Propagation delay time, $A0-A35$ valid to \overline{PEFA} valid; $B0-B35$ valid to \overline{PEFB} valid	3	10	3	11	3	13	ns
$t_{pd}(O-PE)$ Propagation delay time, $ODD/EVEN$ to \overline{PEFA} and \overline{PEFB}	3	11	3	12	3	14	ns
$t_{pd}(O-PB) \P$ Propagation delay time, $ODD/EVEN$ to parity bits ($A8, A17, A26, A35$) and ($B8, B17, B26, B35$)	2	11	2	12	2	14	ns
$t_{pd}(E-PE)$ Propagation delay time, $\overline{CSA}, ENA, W/\overline{RA}, MBA$, or PGA to \overline{PEFA} ; $\overline{CSB}, ENB, W/\overline{RB}, SIZ1, SIZ0$, or PGB to \overline{PEFB}	1	11	1	12	1	14	ns
$t_{pd}(E-PB) \P$ Propagation delay time, MBA or PGA to parity bits ($A8, A17, A26, A35$); $SIZ1, SIZ0$, or PGB to parity bits ($B8, B17, B26, B35$)	3	12	3	13	3	14	ns
$t_{pd}(R-F)$ Propagation delay time, \overline{RST} to ($\overline{MBF1}, \overline{MBF2}$) high	1	15	1	20	1	30	ns
t_{en} Enable time, \overline{CSA} and W/\overline{RA} low to $A0-A35$ active and \overline{CSB} low and W/\overline{RB} high to $B0-B35$ active	2	10	2	12	2	14	ns
t_{dis} Disable time, \overline{CSA} or W/\overline{RA} high to $A0-A35$ at high impedance and \overline{CSB} high or W/\overline{RB} low to $B0-B35$ at high impedance	1	8	1	9	1	11	ns

\dagger Writing data to the mail1 register when the $B0-B35$ outputs are active and $SIZ1, SIZ0$ are high

\ddagger Writing data to the mail2 register when the $A0-A35$ outputs are active and MBA is high

\S Applies only when a new port-B bus size is implemented by the rising $CLKB$ edge

\P Applies only when reading data from a mail register



PARAMETER MEASUREMENT INFORMATION

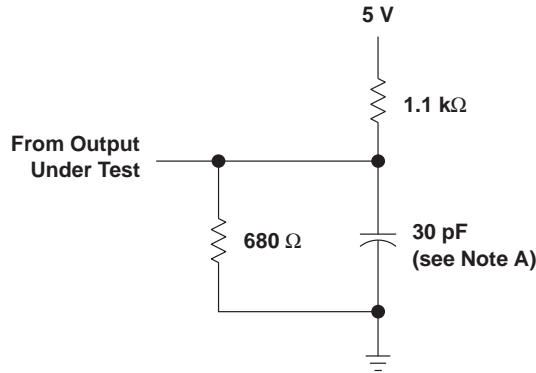

LOAD CIRCUIT

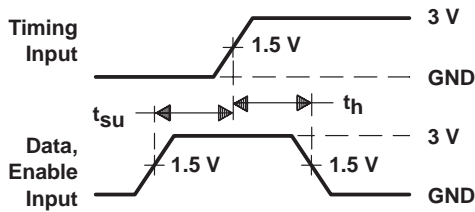

VOLTAGE WAVEFORMS
 SETUP AND HOLD TIMES

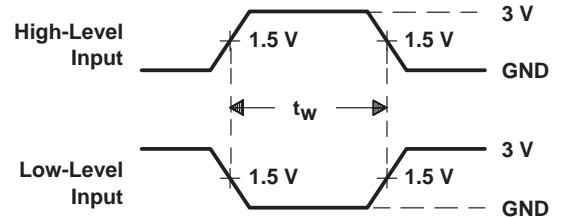

VOLTAGE WAVEFORMS
 PULSE DURATIONS

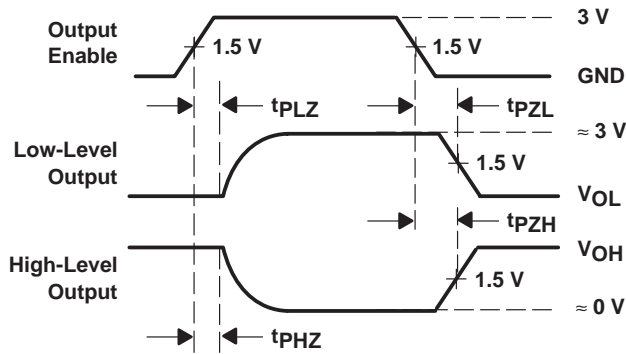

VOLTAGE WAVEFORMS
 ENABLE AND DISABLE TIMES

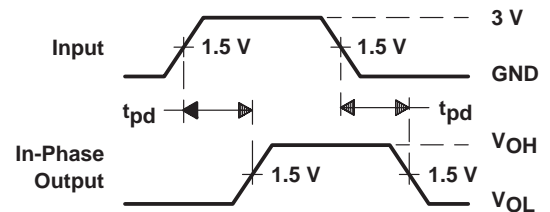

VOLTAGE WAVEFORMS
 PROPAGATION DELAY TIMES

- NOTES: A. Includes probe and jig capacitance
 B. t_{PZL} and t_{PZH} are the same as t_{en} .
 C. t_{PLZ} and t_{PHZ} are the same as t_{dis} .

Figure 27. Load Circuit and Voltage Waveforms

TYPICAL CHARACTERISTICS

SUPPLY CURRENT
vs
CLOCK FREQUENCY

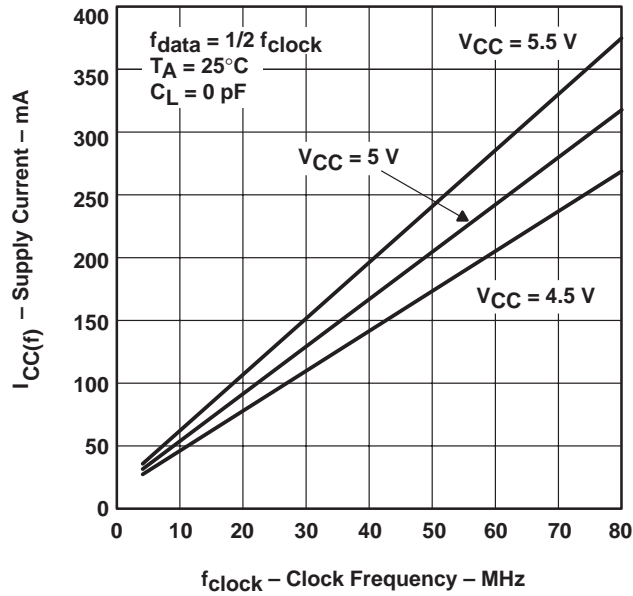

Figure 28

IMPORTANT NOTICE

Texas Instruments and its subsidiaries (TI) reserve the right to make changes to their products or to discontinue any product or service without notice, and advise customers to obtain the latest version of relevant information to verify, before placing orders, that information being relied on is current and complete. All products are sold subject to the terms and conditions of sale supplied at the time of order acknowledgment, including those pertaining to warranty, patent infringement, and limitation of liability.

TI warrants performance of its semiconductor products to the specifications applicable at the time of sale in accordance with TI's standard warranty. Testing and other quality control techniques are utilized to the extent TI deems necessary to support this warranty. Specific testing of all parameters of each device is not necessarily performed, except those mandated by government requirements.

Customers are responsible for their applications using TI components.

In order to minimize risks associated with the customer's applications, adequate design and operating safeguards must be provided by the customer to minimize inherent or procedural hazards.

TI assumes no liability for applications assistance or customer product design. TI does not warrant or represent that any license, either express or implied, is granted under any patent right, copyright, mask work right, or other intellectual property right of TI covering or relating to any combination, machine, or process in which such semiconductor products or services might be or are used. TI's publication of information regarding any third party's products or services does not constitute TI's approval, warranty or endorsement thereof.

Looking for pricing, stock, or lifecycle information?

Click below to explore more details on WIN SOURCE:

 [View SN74ABT3614-15PQ on WIN SOURCE](#)

 [Texas Instruments](#) Information

Optimize Your Supply Chain with WIN SOURCE Solutions

-  Global Sourcing Solution
-  Obsolete Management
-  Cost Control Management
-  Shortage Management
-  Alternative Solution
-  Excess Inventory Management