



**THE DATASHEET OF
SN74AUC16374ZQLR**



FEATURES

- Member of the Texas Instruments Widebus™ Family
- Optimized for 1.8-V Operation and Is 3.6-V I/O Tolerant to Support Mixed-Mode Signal Operation
- I_{off} Supports Partial-Power-Down Mode Operation
- Sub-1-V Operable
- Max t_{pd} of 2.8 ns at 1.8 V
- Low Power Consumption, 20- μ A Max I_{CC}
- ± 8 -mA Output Drive at 1.8 V
- Latch-Up Performance Exceeds 100 mA Per JESD 78, Class II
- ESD Protection Exceeds JESD 22
 - 2000-V Human-Body Model (A114-A)
 - 200-V Machine Model (A115-A)
 - 1000-V Charged-Device Model (C101)

DESCRIPTION/ORDERING INFORMATION

This 16-bit edge-triggered D-type flip-flop is operational at 0.8-V to 2.7-V V_{CC} , but is designed specifically for 1.65-V to 1.95-V V_{CC} operation.

The SN74AUC16374 is particularly suitable for implementing buffer registers, I/O ports, bidirectional bus drivers, and working registers. It can be used as two 8-bit flip-flops or one 16-bit flip-flop. On the positive transition of the clock (CLK) input, the Q outputs of the flip-flop take on the logic levels set up at the data (D) inputs.

A buffered output-enable (\overline{OE}) input can be used to place the eight outputs in either a normal logic state (high or low logic levels) or the high-impedance state. In the high-impedance state, the outputs neither load nor drive the bus lines significantly. The high-impedance state and increased drive provide the capability to drive bus lines without interface or pullup components.

\overline{OE} does not affect internal operations of the latch. Old data can be retained or new data can be entered while the outputs are in the high-impedance state.

DGG OR DGV PACKAGE
(TOP VIEW)

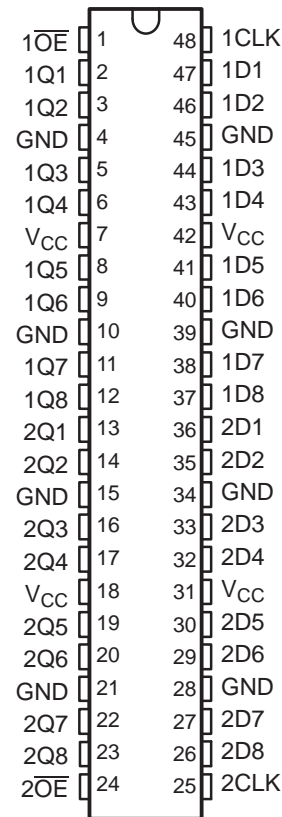

ORDERING INFORMATION

T_A	PACKAGE ⁽¹⁾⁽²⁾		ORDERABLE PART NUMBER	TOP-SIDE MARKING
-40°C to 85°C	TSSOP – DGG	Reel of 2000	SN74AUC16374DGGR	AUC16374
	TVSOP – DGV	Reel of 2000	SN74AUC16374DGVV	MH374
	VFBGA – ZQL	Reel of 1000	SN74AUC16374ZQLR	MH374

(1) Package drawings, standard packing quantities, thermal data, symbolization, and PCB design guidelines are available at www.ti.com/sc/package.

(2) For the most current package and ordering information, see the Package Option Addendum at the end of this document, or see the TI website at www.ti.com.



Please be aware that an important notice concerning availability, standard warranty, and use in critical applications of Texas Instruments semiconductor products and disclaimers thereto appears at the end of this data sheet.

Widebus is a trademark of Texas Instruments.

SN74AUC16374

16-BIT EDGE-TRIGGERED D-TYPE FLIP-FLOP WITH 3-STATE OUTPUTS

SCES403E—JULY 2002—REVISED APRIL 2007

DESCRIPTION/ORDERING INFORMATION (CONTINUED)

To ensure the high-impedance state during power up or power down, \overline{OE} should be tied to V_{CC} through a pullup resistor; the minimum value of the resistor is determined by the current-sinking capability of the driver.

This device is fully specified for partial-power-down applications using I_{off} . The I_{off} circuitry disables the outputs, preventing damaging current backflow through the device when it is powered down.

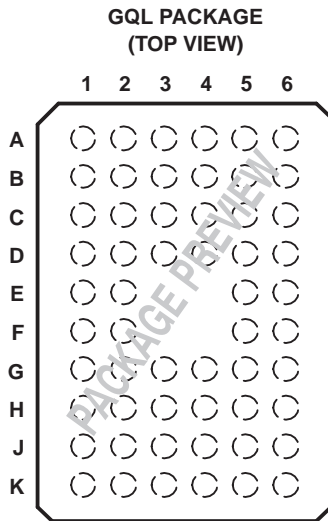

TERMINAL ASSIGNMENTS⁽¹⁾

	1	2	3	4	5	6
A	$1\overline{OE}$	NC	NC	NC	NC	1CLK
B	1Q2	1Q1	GND	GND	1D1	1D2
C	1Q4	1Q3	V_{CC}	V_{CC}	1D3	1D4
D	1Q6	1Q5	GND	GND	1D5	1D6
E	1Q8	1Q7			1D7	1D8
F	2Q1	2Q2			2D2	2D1
G	2Q3	2Q4	GND	GND	2D4	2D3
H	2Q5	2Q6	V_{CC}	V_{CC}	2D6	2D5
J	2Q7	2Q8	GND	GND	2D8	2D7
K	$2\overline{OE}$	NC	NC	NC	NC	2CLK

(1) NC - No internal connection

FUNCTION TABLE (EACH FLIP-FLOP)

INPUTS			OUTPUT Q
\overline{OE}	CLK	D	
L	↑	H	H
L	↑	L	L
L	H or L	X	Q_0
H	X	X	Z

LOGIC DIAGRAM (POSITIVE LOGIC)

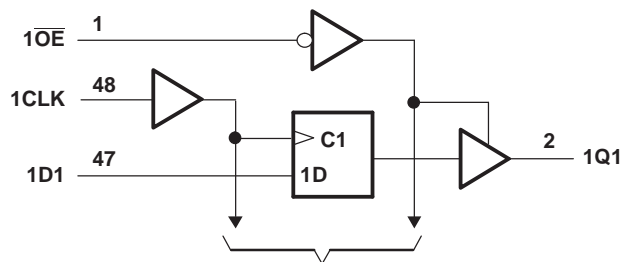

To Seven Other Channels

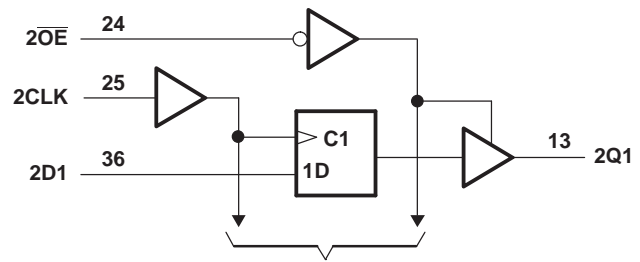

To Seven Other Channels

Pin numbers shown are for the DGG and DGV packages.

Absolute Maximum Ratings⁽¹⁾

over operating free-air temperature range (unless otherwise noted)

		MIN	MAX	UNIT
V _{CC}	Supply voltage range	–0.5	3.6	V
V _I	Input voltage range ⁽²⁾	–0.5	3.6	V
V _O	Voltage range applied to any output in the high-impedance or power-off state ⁽²⁾	–0.5	3.6	V
V _O	Output voltage range ⁽²⁾	–0.5	V _{CC} + 0.5	V
I _{IK}	Input clamp current	V _I < 0	–50	mA
I _{OK}	Output clamp current	V _O < 0	–50	mA
I _O	Continuous output current		±20	mA
	Continuous current through V _{CC} or GND		±100	mA
θ _{JA}	Package thermal impedance ⁽³⁾	DGG package	70	°C/W
		DGV package	58	
		GQL package	42	
T _{stg}	Storage temperature range	–65	150	°C

- (1) Stresses beyond those listed under "absolute maximum ratings" may cause permanent damage to the device. These are stress ratings only, and functional operation of the device at these or any other conditions beyond those indicated under "recommended operating conditions" is not implied. Exposure to absolute-maximum-rated conditions for extended periods may affect device reliability.
- (2) The input negative-voltage and output voltage ratings may be exceeded if the input and output current ratings are observed.
- (3) The package thermal impedance is calculated in accordance with JESD 51-7.

Recommended Operating Conditions⁽¹⁾

		MIN	MAX	UNIT
V _{CC}	Supply voltage	0.8	2.7	V
V _{IH}	High-level input voltage	V _{CC} = 0.8 V	V _{CC}	V
		V _{CC} = 1.1 V to 1.95 V	0.65 × V _{CC}	
		V _{CC} = 2.3 V to 2.7 V	1.7	
V _{IL}	Low-level input voltage	V _{CC} = 0.8 V	0	V
		V _{CC} = 1.1 V to 1.95 V	0.35 × V _{CC}	
		V _{CC} = 2.3 V to 2.7 V	0.7	
V _I	Input voltage	0	3.6	V
V _O	Output voltage	0	V _{CC}	V
I _{OH}	High-level output current	V _{CC} = 0.8 V	–0.7	mA
		V _{CC} = 1.1 V	–3	
		V _{CC} = 1.4 V	–5	
		V _{CC} = 1.65 V	–8	
		V _{CC} = 2.3 V	–9	
I _{OL}	Low-level output current	V _{CC} = 0.8 V	0.7	mA
		V _{CC} = 1.1 V	3	
		V _{CC} = 1.4 V	5	
		V _{CC} = 1.65 V	8	
		V _{CC} = 2.3 V	9	
Δt/Δv	Input transition rise or fall rate		20	ns/V
T _A	Operating free-air temperature	–40	85	°C

- (1) All unused inputs of the device must be held at V_{CC} or GND to ensure proper device operation. Refer to the TI application report, *Implications of Slow or Floating CMOS Inputs*, literature number SCBA004.

SN74AUC16374

16-BIT EDGE-TRIGGERED D-TYPE FLIP-FLOP WITH 3-STATE OUTPUTS

SCES403E–JULY 2002–REVISED APRIL 2007

Electrical Characteristics

over recommended operating free-air temperature range (unless otherwise noted)

PARAMETER		TEST CONDITIONS	V _{CC}	MIN	TYP ⁽¹⁾	MAX	UNIT
V _{OH}		I _{OH} = -100 μA	0.8 V to 2.7 V	V _{CC} - 0.1			V
		I _{OH} = -0.7 mA	0.8 V	0.55			
		I _{OH} = -3 mA	1.1 V	0.8			
		I _{OH} = -5 mA	1.4 V	1			
		I _{OH} = -8 mA	1.65 V	1.2			
		I _{OH} = -9 mA	2.3 V	1.8			
V _{OL}		I _{OL} = 100 μA	0.8 V to 2.7 V			0.2	V
		I _{OL} = 0.7 mA	0.8 V			0.25	
		I _{OL} = 3 mA	1.1 V			0.3	
		I _{OL} = 5 mA	1.4 V			0.4	
		I _{OL} = 8 mA	1.65 V			0.45	
		I _{OL} = 9 mA	2.3 V			0.6	
I _I	All inputs	V _I = V _{CC} or GND	0 to 2.7 V			±5	μA
I _{off}		V _I or V _O = 2.7 V	0			±10	μA
I _{OZ}		V _O = V _{CC} or GND	2.7 V			±10	μA
I _{CC}		V _I = V _{CC} or GND, I _O = 0	0.8 V to 2.7 V			20	μA
C _i		V _I = V _{CC} or GND	2.5 V			3	pF
C _o		V _O = V _{CC} or GND	2.5 V			5	pF

(1) All typical values are at T_A = 25°C.

Timing Requirements

over recommended operating free-air temperature range (unless otherwise noted) (see Figure 1)

		V _{CC} = 0.8 V	V _{CC} = 1.2 V ± 0.1 V		V _{CC} = 1.5 V ± 0.1 V		V _{CC} = 1.8 V ± 0.15 V		V _{CC} = 2.5 V ± 0.2 V		UNIT
		TYP	MIN	MAX	MIN	MAX	MIN	MAX	MIN	MAX	
f _{clock}	Clock frequency	85	250		250		250		250		MHz
t _w	Pulse duration, CLK high or low	5.9	1.9	4.5	1.9	2.9	1.9	2.8	1.9	2.2	ns
t _{su}	Setup time, data before CLK↑	1.4	1.2	5.3	0.7	3.6	0.6	2.9	0.6	2.2	ns
t _h	Hold time, data after CLK↑	0.1	0.4	7.1	0.4	4.8	0.4	4.5	0.4	2.2	ns

Switching Characteristics

over recommended operating free-air temperature range (unless otherwise noted) (see Figure 1)

PARAMETER	FROM (INPUT)	TO (OUTPUT)	V _{CC} = 0.8 V	V _{CC} = 1.2 V ± 0.1 V		V _{CC} = 1.5 V ± 0.1 V		V _{CC} = 1.8 V ± 0.15 V			V _{CC} = 2.5 V ± 0.2 V		UNIT
			TYP	MIN	MAX	MIN	MAX	MIN	TYP	MAX	MIN	MAX	
f _{max}			85	250		250		250			250		MHz
t _{pd}	CLK	Q	7.3	1	4.5	0.8	2.9	0.7	1.5	2.8	0.7	2.2	ns
t _{en}	\overline{OE}	Q	7	1.2	5.3	0.8	3.6	0.8	1.5	2.9	0.7	2.2	ns
t _{dis}	\overline{OE}	Q	8.2	2	7.1	1	4.8	1.4	2.7	4.5	0.5	2.2	ns

Operating Characteristics⁽¹⁾
 $T_A = 25^\circ\text{C}$

PARAMETER			TEST CONDITIONS	$V_{CC} = 0.8\text{ V}$	$V_{CC} = 1.2\text{ V}$	$V_{CC} = 1.5\text{ V}$	$V_{CC} = 1.8\text{ V}$	$V_{CC} = 2.5\text{ V}$	UNIT
				TYP	TYP	TYP	TYP	TYP	
C_{pd} (each output) ⁽²⁾	Power dissipation capacitance	Outputs enabled, 1 output switching	1 $f_{data} = 5\text{ MHz}$, 1 $f_{clk} = 10\text{ MHz}$, 1 $f_{out} = 5\text{ MHz}$, $\overline{OE} = \text{GND}$, $C_L = 0\text{ pF}$	24	24	24.1	26.2	31.2	pF
$C_{pd(Z)}$	Power dissipation capacitance	Outputs disabled, 1 clock and 1 data switching	1 $f_{data} = 5\text{ MHz}$, 1 $f_{clk} = 10\text{ MHz}$, $f_{out} = \text{not switching}$, $\overline{OE} = V_{CC}$, $C_L = 0\text{ pF}$	7.5	7.5	8	9.4	13.2	pF
C_{pd} (each clock) ⁽³⁾	Power dissipation capacitance	Outputs disabled, clock only switching	1 $f_{data} = 0\text{ MHz}$, 1 $f_{clk} = 10\text{ MHz}$, $f_{out} = \text{not switching}$, $\overline{OE} = V_{CC}$, $C_L = 0\text{ pF}$	13.8	13.8	14	14.7	17.5	pF

(1) Total device C_{pd} for multiple (n) outputs switching and (y) clocks inputs switching = $\{n * C_{pd} \text{ (each output)}\} + \{y * C_{pd} \text{ (each clock)}\}$

(2) C_{pd} (each output) is the C_{pd} for each data bit (input and output circuitry) as it operates at 5 MHz (Note: the clock is operating at 10 MHz in this test, but its I_{CC} component has been subtracted out).

(3) C_{pd} (each clock) is the C_{pd} for the clock circuitry only as it operates at 10 MHz.

PARAMETER MEASUREMENT INFORMATION

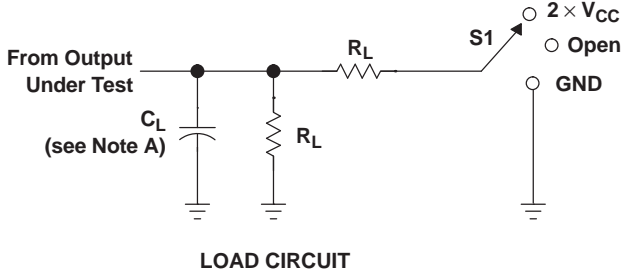

TEST	S1
t_{PLH}/t_{PHL}	Open
t_{PLZ}/t_{PZL}	$2 \times V_{CC}$
t_{PHZ}/t_{PZH}	GND

V_{CC}	C_L	R_L	V_{Δ}
0.8 V	15 pF	2 k Ω	0.1 V
1.2 V \pm 0.1 V	15 pF	2 k Ω	0.1 V
1.5 V \pm 0.1 V	15 pF	2 k Ω	0.1 V
1.8 V \pm 0.15 V	30 pF	1 k Ω	0.15 V
2.5 V \pm 0.2 V	30 pF	500 Ω	0.15 V

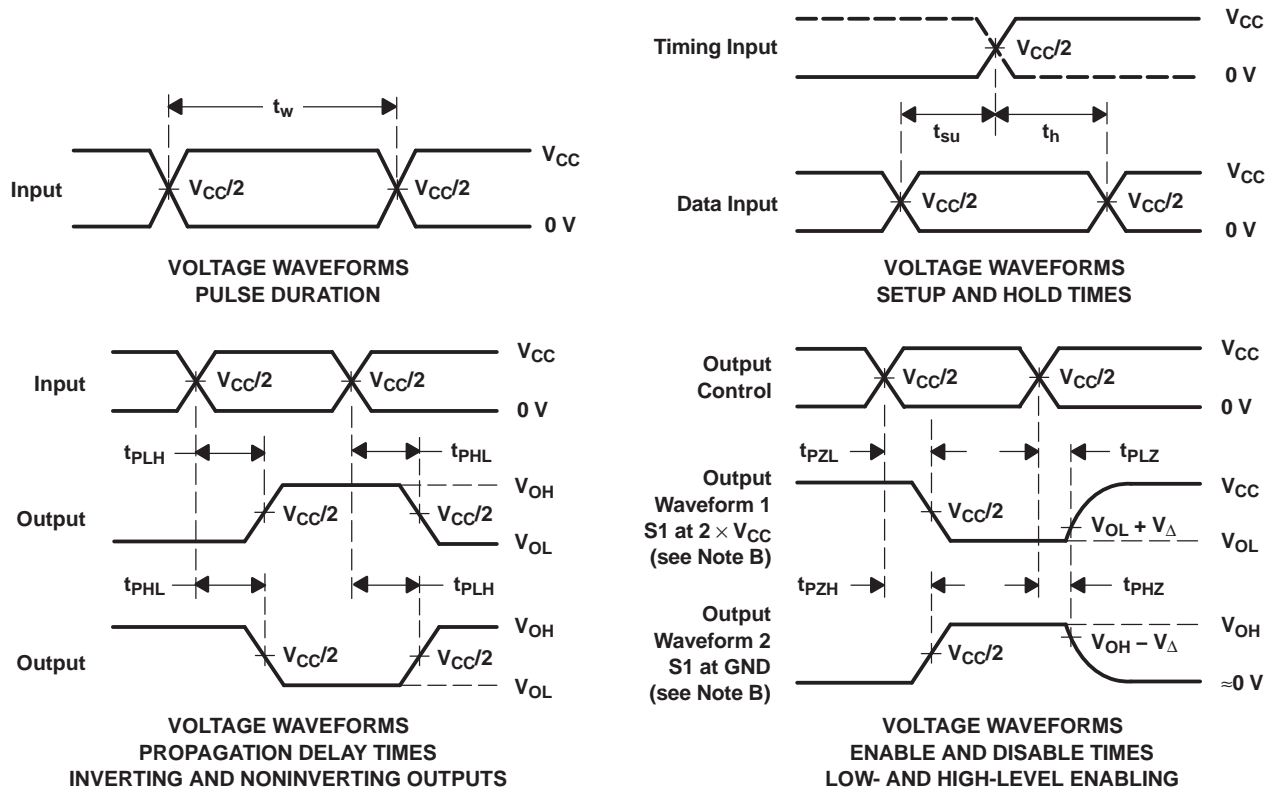

- NOTES:
- C_L includes probe and jig capacitance.
 - Waveform 1 is for an output with internal conditions such that the output is low, except when disabled by the output control. Waveform 2 is for an output with internal conditions such that the output is high, except when disabled by the output control.
 - All input pulses are supplied by generators having the following characteristics: PRR \leq 10 MHz, $Z_O = 50 \Omega$, slew rate ≥ 1 V/ns.
 - The outputs are measured one at a time, with one transition per measurement.
 - t_{PLZ} and t_{PHZ} are the same as t_{dis} .
 - t_{PZL} and t_{PZH} are the same as t_{en} .
 - t_{PLH} and t_{PHL} are the same as t_{pd} .
 - All parameters and waveforms are not applicable to all devices.

Figure 1. Load Circuit and Voltage Waveforms

PACKAGING INFORMATION

Orderable Device	Status (1)	Package Type	Package Drawing	Pins	Package Qty	Eco Plan (2)	Lead finish/ Ball material (6)	MSL Peak Temp (3)	Op Temp (°C)	Device Marking (4/5)	Samples
SN74AUC16374DGGR	ACTIVE	TSSOP	DGG	48	2000	RoHS & Green	NIPDAU	Level-1-260C-UNLIM	-40 to 85	AUC16374	Samples
SN74AUC16374DGVR	ACTIVE	TVSOP	DGV	48	2000	RoHS & Green	NIPDAU	Level-1-260C-UNLIM	-40 to 85	MH374	Samples

(1) The marketing status values are defined as follows:

ACTIVE: Product device recommended for new designs.

LIFEBUY: TI has announced that the device will be discontinued, and a lifetime-buy period is in effect.

NRND: Not recommended for new designs. Device is in production to support existing customers, but TI does not recommend using this part in a new design.

PREVIEW: Device has been announced but is not in production. Samples may or may not be available.

OBSOLETE: TI has discontinued the production of the device.

(2) **RoHS:** TI defines "RoHS" to mean semiconductor products that are compliant with the current EU RoHS requirements for all 10 RoHS substances, including the requirement that RoHS substance do not exceed 0.1% by weight in homogeneous materials. Where designed to be soldered at high temperatures, "RoHS" products are suitable for use in specified lead-free processes. TI may reference these types of products as "Pb-Free".

RoHS Exempt: TI defines "RoHS Exempt" to mean products that contain lead but are compliant with EU RoHS pursuant to a specific EU RoHS exemption.

Green: TI defines "Green" to mean the content of Chlorine (Cl) and Bromine (Br) based flame retardants meet JS709B low halogen requirements of <=1000ppm threshold. Antimony trioxide based flame retardants must also meet the <=1000ppm threshold requirement.

(3) MSL, Peak Temp. - The Moisture Sensitivity Level rating according to the JEDEC industry standard classifications, and peak solder temperature.

(4) There may be additional marking, which relates to the logo, the lot trace code information, or the environmental category on the device.

(5) Multiple Device Markings will be inside parentheses. Only one Device Marking contained in parentheses and separated by a "~" will appear on a device. If a line is indented then it is a continuation of the previous line and the two combined represent the entire Device Marking for that device.

(6) Lead finish/Ball material - Orderable Devices may have multiple material finish options. Finish options are separated by a vertical ruled line. Lead finish/Ball material values may wrap to two lines if the finish value exceeds the maximum column width.

Important Information and Disclaimer:The information provided on this page represents TI's knowledge and belief as of the date that it is provided. TI bases its knowledge and belief on information provided by third parties, and makes no representation or warranty as to the accuracy of such information. Efforts are underway to better integrate information from third parties. TI has taken and continues to take reasonable steps to provide representative and accurate information but may not have conducted destructive testing or chemical analysis on incoming materials and chemicals. TI and TI suppliers consider certain information to be proprietary, and thus CAS numbers and other limited information may not be available for release.

In no event shall TI's liability arising out of such information exceed the total purchase price of the TI part(s) at issue in this document sold by TI to Customer on an annual basis.

TAPE AND REEL INFORMATION

QUADRANT ASSIGNMENTS FOR PIN 1 ORIENTATION IN TAPE

*All dimensions are nominal

Device	Package Type	Package Drawing	Pins	SPQ	Reel Diameter (mm)	Reel Width W1 (mm)	A0 (mm)	B0 (mm)	K0 (mm)	P1 (mm)	W (mm)	Pin1 Quadrant
SN74AUC16374DGGR	TSSOP	DGG	48	2000	330.0	24.4	8.6	13.0	1.8	12.0	24.0	Q1
SN74AUC16374DGVR	TVSOP	DGV	48	2000	330.0	16.4	7.1	10.2	1.6	12.0	16.0	Q1

TAPE AND REEL BOX DIMENSIONS

*All dimensions are nominal

Device	Package Type	Package Drawing	Pins	SPQ	Length (mm)	Width (mm)	Height (mm)
SN74AUC16374DGGR	TSSOP	DGG	48	2000	367.0	367.0	45.0
SN74AUC16374DGVR	TVSOP	DGV	48	2000	356.0	356.0	35.0

DGV (R-PDSO-G**)

PLASTIC SMALL-OUTLINE

24 PINS SHOWN



- NOTES: A. All linear dimensions are in millimeters.
 B. This drawing is subject to change without notice.
 C. Body dimensions do not include mold flash or protrusion, not to exceed 0,15 per side.
 D. Falls within JEDEC: 24/48 Pins – MO-153
 14/16/20/56 Pins – MO-194



4214859/B 11/2020

NOTES:

1. All linear dimensions are in millimeters. Any dimensions in parenthesis are for reference only. Dimensioning and tolerancing per ASME Y14.5M.
2. This drawing is subject to change without notice.
3. This dimension does not include mold flash, protrusions, or gate burrs. Mold flash, protrusions, or gate burrs shall not exceed 0.15 mm per side.
4. Reference JEDEC registration MO-153.

EXAMPLE BOARD LAYOUT

DGG0048A

TSSOP - 1.2 mm max height

SMALL OUTLINE PACKAGE

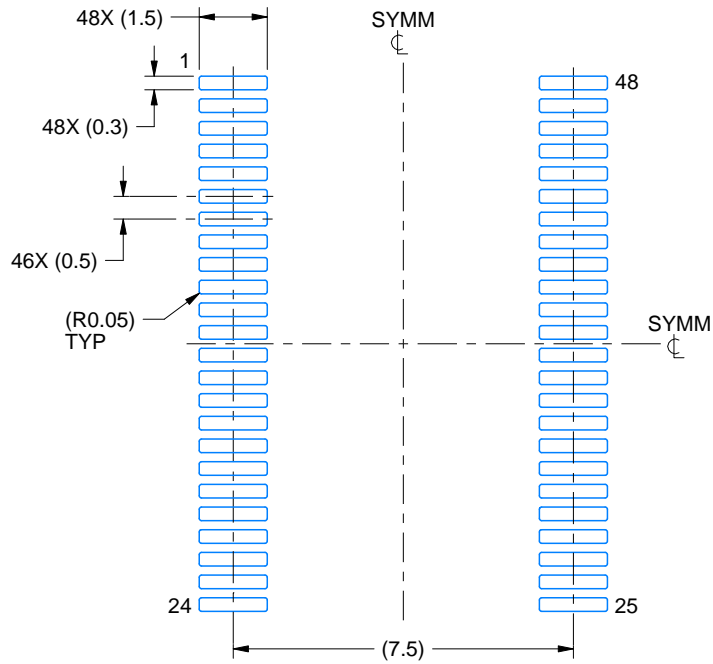

LAND PATTERN EXAMPLE
SCALE:6X



SOLDER MASK DETAILS

4214859/B 11/2020

NOTES: (continued)

- 5. Publication IPC-7351 may have alternate designs.
- 6. Solder mask tolerances between and around signal pads can vary based on board fabrication site.

EXAMPLE STENCIL DESIGN

DGG0048A

TSSOP - 1.2 mm max height

SMALL OUTLINE PACKAGE



SOLDER PASTE EXAMPLE
BASED ON 0.125 mm THICK STENCIL
SCALE:6X

4214859/B 11/2020

NOTES: (continued)

7. Laser cutting apertures with trapezoidal walls and rounded corners may offer better paste release. IPC-7525 may have alternate design recommendations.
8. Board assembly site may have different recommendations for stencil design.

DGG (R-PDSO-G**)

PLASTIC SMALL-OUTLINE PACKAGE

48 PINS SHOWN



- NOTES: A. All linear dimensions are in millimeters.
 B. This drawing is subject to change without notice.
 C. Body dimensions do not include mold protrusion not to exceed 0,15.
 D. Falls within JEDEC MO-153

IMPORTANT NOTICE AND DISCLAIMER

TI PROVIDES TECHNICAL AND RELIABILITY DATA (INCLUDING DATA SHEETS), DESIGN RESOURCES (INCLUDING REFERENCE DESIGNS), APPLICATION OR OTHER DESIGN ADVICE, WEB TOOLS, SAFETY INFORMATION, AND OTHER RESOURCES "AS IS" AND WITH ALL FAULTS, AND DISCLAIMS ALL WARRANTIES, EXPRESS AND IMPLIED, INCLUDING WITHOUT LIMITATION ANY IMPLIED WARRANTIES OF MERCHANTABILITY, FITNESS FOR A PARTICULAR PURPOSE OR NON-INFRINGEMENT OF THIRD PARTY INTELLECTUAL PROPERTY RIGHTS.

These resources are intended for skilled developers designing with TI products. You are solely responsible for (1) selecting the appropriate TI products for your application, (2) designing, validating and testing your application, and (3) ensuring your application meets applicable standards, and any other safety, security, regulatory or other requirements.

These resources are subject to change without notice. TI grants you permission to use these resources only for development of an application that uses the TI products described in the resource. Other reproduction and display of these resources is prohibited. No license is granted to any other TI intellectual property right or to any third party intellectual property right. TI disclaims responsibility for, and you will fully indemnify TI and its representatives against, any claims, damages, costs, losses, and liabilities arising out of your use of these resources.

TI's products are provided subject to [TI's Terms of Sale](#) or other applicable terms available either on ti.com or provided in conjunction with such TI products. TI's provision of these resources does not expand or otherwise alter TI's applicable warranties or warranty disclaimers for TI products.

TI objects to and rejects any additional or different terms you may have proposed.

Mailing Address: Texas Instruments, Post Office Box 655303, Dallas, Texas 75265
Copyright © 2022, Texas Instruments Incorporated

Looking for pricing, stock, or lifecycle information?

Click below to explore more details on WIN SOURCE:

 [View SN74AUC16374ZQLR on WIN SOURCE](#)

 [Texas Instruments](#) Information

Optimize Your Supply Chain with WIN SOURCE Solutions

-  Global Sourcing Solution
-  Obsolete Management
-  Cost Control Management
-  Shortage Management
-  Alternative Solution
-  Excess Inventory Management