



**THE DATASHEET OF  
SN74AHC04QPWRQ1**



## SN74AHC04-Q1 Automotive Hex Inverter

### 1 Features

- Qualified for automotive applications
- EPIC™ (Enhanced-Performance Implanted CMOS) Process
- Operating range of 2-V to 5.5-V  $V_{CC}$

### 2 Applications

- [Synchronize inverted clock inputs](#)
- [Debounce a switch](#)
- Invert a digital signal

### 3 Description

The SN74AHC04 contains six independent inverters. This device performs the Boolean function  $Y = \bar{A}$ .

#### Package Information

PART NUMBER	PACKAGE <sup>(1)</sup>	PACKAGE SIZE <sup>2</sup>
SN74AHC04-Q1	D (SOIC, 14)	8.65 mm × 6 mm
	PW (TSSOP, 14)	5 mm × 6.4 mm
	BQA (WQFN, 14)	3 mm × 2.5 mm

- (1) For all available packages, see the orderable addendum at the end of the data sheet.
- (2) The package size (length × width) is a nominal value and includes pins, where applicable.

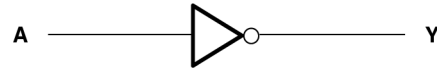

## Table of Contents

<b>1 Features</b> .....	<b>1</b>	<b>8 Detailed Description</b> .....	<b>8</b>
<b>2 Applications</b> .....	<b>1</b>	8.1 Functional Block Diagram.....	8
<b>3 Description</b> .....	<b>1</b>	8.2 Device Functional Modes.....	8
<b>4 Revision History</b> .....	<b>2</b>	<b>9 Application and Implementation</b> .....	<b>9</b>
<b>5 Pin Configuration and Functions</b> .....	<b>3</b>	9.1 Power Supply Recommendations.....	9
<b>6 Specifications</b> .....	<b>4</b>	9.2 Layout.....	9
6.1 Absolute Maximum Ratings.....	4	<b>10 Device and Documentation Support</b> .....	<b>10</b>
6.2 ESD Ratings.....	4	10.1 Document Support (Analog).....	10
6.3 Recommended Operating Conditions.....	4	10.2 Receiving Notification of Documentation Updates..	10
6.4 Thermal Information.....	5	10.3 Support Resources.....	10
6.5 Electrical Characteristics.....	5	10.4 Trademarks.....	10
6.6 Switching Characteristics, $V_{CC} = 3.3\text{ V} \pm 0.3\text{ V}$ .....	5	10.5 Electrostatic Discharge Caution.....	10
6.7 Switching Characteristics, $V_{CC} = 5\text{ V} \pm 0.5\text{ V}$ .....	5	10.6 Glossary.....	10
6.8 Noise Characteristics.....	6	<b>11 Mechanical, Packaging, and Orderable Information</b> .....	<b>10</b>
6.9 Operating Characteristics.....	6		
<b>7 Parameter Measurement Information</b> .....	<b>7</b>		

## 4 Revision History

NOTE: Page numbers for previous revisions may differ from page numbers in the current version.

### Changes from Revision C (April 2023) to Revision D (June 2023) Page

• Added BQA package to <i>Package Information</i> table.....	<b>1</b>
• Updated thermal values for PW package from $R\theta_{JA} = 113$ to $147.7$ , all values in $^{\circ}\text{C}/\text{W}$ .....	<b>5</b>
• Added thermal value for $R\theta_{JA}$ : BQA = $88.3$ , all values in $^{\circ}\text{C}/\text{W}$ .....	<b>5</b>

### Changes from Revision B (April 2008) to Revision C (April 2023) Page

• Added <i>Applications</i> , <i>Package Information</i> table, <i>Pin Functions</i> table, <i>ESD Ratings</i> table, <i>Thermal Information</i> table, <i>Device Functional Modes</i> , <i>Application and Implementation</i> section, <i>Power Supply Recommendations</i> section, <i>Layout</i> section, <i>Device and Documentation Support</i> section, and <i>Mechanical, Packaging, and Orderable Information</i> section.....	<b>1</b>
---	----------

## 5 Pin Configuration and Functions

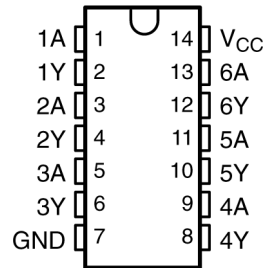

**Figure 5-1. D or PW Package (Top View)**

**Table 5-1. Pin Functions**

PIN		I/O	DESCRIPTION
NAME	NO.		
1A	1	Input	Channel 1, Input A
1Y	2	Output	Channel 1, Output Y
2A	3	Input	Channel 2, Input A
2Y	4	Output	Channel 2, Output Y
3A	5	Input	Channel 3, Input A
3Y	6	Output	Channel 3, Output Y
GND	7	—	Ground
4Y	8	Output	Channel 4, Output Y
4A	9	Input	Channel 4, Input A
5Y	10	Output	Channel 5, Output Y
5A	11	Input	Channel 5, Input A
6Y	12	Output	Channel 6, Output Y
6A	13	Input	Channel 6, Input A
V <sub>CC</sub>	14	—	Positive Supply
Thermal Pad <sup>1</sup>		—	The thermal pad can be connected to GND or left floating. Do not connect to any other signal or supply

1. BQA Package only.

## 6 Specifications

### 6.1 Absolute Maximum Ratings

over operating free-air temperature range (unless otherwise noted)<sup>1</sup>

		MIN	MAX	UNIT
V <sub>CC</sub>	Supply voltage range	-0.5	7	V
V <sub>I</sub> <sup>2</sup>	Input voltage range	-0.5	7	V
V <sub>O</sub> <sup>2</sup>	Output voltage range	-0.5	V <sub>CC</sub> + 0.5	V
I <sub>IK</sub>	Input clamp current	(V <sub>I</sub> < 0)	-20	mA
I <sub>OK</sub>	Output clamp current	(V <sub>O</sub> < 0 or V <sub>O</sub> > V <sub>CC</sub> )	±20	mA
I <sub>O</sub>	Continuous output current	(V <sub>O</sub> = 0 to V <sub>CC</sub> )	±25	mA
	Continuous current through V <sub>CC</sub> or GND		±50	mA
T <sub>stg</sub>	Storage temperature range	-65	150	°C

(1) The input and output voltage ratings may be exceeded if the input and output current ratings are observed.

### 6.2 ESD Ratings

			VALUE	UNIT
V <sub>(ESD)</sub>	Electrostatic discharge	Human body model (HBM) <sup>1</sup>	±1500	V

(1) AEC Q100-002 indicate that HBM stressing shall be in accordance with the ANSI/ESDA/JEDEC JS-001 specification.

### 6.3 Recommended Operating Conditions

over recommended operating free-air temperature range (unless otherwise noted)<sup>1</sup>

		MIN	MAX	UNIT
V <sub>CC</sub>	Supply voltage	2	5.5	V
V <sub>IH</sub>	High-level input voltage	V <sub>CC</sub> = 2 V	1.5	V
		V <sub>CC</sub> = 3 V	2.1	
		V <sub>CC</sub> = 5.5 V	3.85	
V <sub>IL</sub>	Low-level input voltage	V <sub>CC</sub> = 2 V	0.5	V
		V <sub>CC</sub> = 3 V	0.9	
		V <sub>CC</sub> = 5.5 V	1.65	
V <sub>I</sub>	Input voltage	0	5.5	V
V <sub>O</sub>	Output voltage	0	V <sub>CC</sub>	V
I <sub>OH</sub>	High-level output current	V <sub>CC</sub> = 2 V	-50	μA
		V <sub>CC</sub> = 3.3 V ± 0.3 V	-4	mA
		V <sub>CC</sub> = 5 V ± 0.5 V	-8	
I <sub>OL</sub>	Low-level output current	V <sub>CC</sub> = 2 V	50	μA
		V <sub>CC</sub> = 3.3 V ± 0.3 V	4	mA
		V <sub>CC</sub> = 5 V ± 0.5 V	8	
Δt/Δv	Input transition rise or fall rate	V <sub>CC</sub> = 3.3 V ± 0.3 V	100	ns/V
		V <sub>CC</sub> = 5 V ± 0.5 V	20	
T <sub>A</sub>	Operating free-air temperature	-40	125	°C

(1) All unused inputs of the device must be held at V<sub>CC</sub> or GND to ensure proper device operation. Refer to the TI application report, *Implications of Slow or Floating CMOS Inputs*, literature number SCBA004.

## 6.4 Thermal Information

THERMAL METRIC <sup>(1)</sup>	SN74AHC04-Q1			UNIT
	D (SOIC)	PW (TSSOP)	BQA (WQFN)	
	14 PINS	14 PINS	14 PINS	
R <sub>θJA</sub> Junction-to-ambient thermal resistance	86	147.7	88.3	°C/W

(1) For more information about traditional and new thermal metrics, see the *IC Package Thermal Metrics* application report, ([SPRA953](#)).

## 6.5 Electrical Characteristics

over recommended operating free-air temperature range (unless otherwise noted)

PARAMETER	TEST CONDITIONS	V <sub>CC</sub>	T <sub>A</sub> = 25°C			MIN	MAX	UNIT
			MIN	TYP	MAX			
V <sub>OH</sub>	I <sub>OH</sub> = -50 μA	2 V	1.9	2		1.9	V	
		3 V	2.9	3		2.9		
		4.5 V	4.4	4.5		4.4		
	I <sub>OH</sub> = -4 mA	3 V	2.58		2.48			
	I <sub>OH</sub> = -8 mA	4.5 V	3.94		3.8			
V <sub>OL</sub>	I <sub>OL</sub> = 50 μA	2 V			0.1	0.1	V	
		3 V			0.1	0.1		
		4.5 V			0.1	0.1		
	I <sub>OL</sub> = 4 mA	3 V		0.36	0.5			
	I <sub>OL</sub> = 8 mA	4.5 V		0.36	0.5			
I <sub>I</sub>	V <sub>I</sub> = 5.5 V or GND	0 V to 5.5 V			±0.1	±1	μA	
I <sub>CC</sub>	V <sub>I</sub> = V <sub>CC</sub> or GND, I <sub>O</sub> = 0	5.5 V			2	20	μA	
C <sub>i</sub>	V <sub>I</sub> = V <sub>CC</sub> or GND	5 V		2	10		pF	

## 6.6 Switching Characteristics, V<sub>CC</sub> = 3.3 V ± 0.3 V

over recommended operating free-air temperature range, V<sub>CC</sub> = 3.3 V ± 0.3 V (unless otherwise noted) (see [Load Circuit and Voltage Waveforms](#))

PARAMETER	FROM (INPUT)	TO (OUTPUT)	LOAD CAPACITANCE	T <sub>A</sub> = 25°C			MIN	MAX	UNIT
				MIN	TYP	MAX			
t <sub>PLH</sub>	A	Y	C <sub>L</sub> = 15 pF		5	8.9	1	10.5	ns
t <sub>PHL</sub>					5	8.9	1	10.5	
t <sub>PLH</sub>	A	Y	C <sub>L</sub> = 50 pF		7.5	11.4	1	13	ns
t <sub>PHL</sub>					7.5	11.4	1	13	

## 6.7 Switching Characteristics, V<sub>CC</sub> = 5 V ± 0.5 V

over recommended operating free-air temperature range, V<sub>CC</sub> = 5 V ± 0.5 V (unless otherwise noted) (see [Load Circuit and Voltage Waveforms](#))

PARAMETER	FROM (INPUT)	TO (OUTPUT)	LOAD CAPACITANCE	T <sub>A</sub> = 25°C			MIN	MAX	UNIT
				MIN	TYP	MAX			
t <sub>PLH</sub>	A	Y	C <sub>L</sub> = 15 pF		3.8	5.5	1	6.5	ns
t <sub>PHL</sub>					3.8	5.5	1	6.5	
t <sub>PLH</sub>	A	Y	C <sub>L</sub> = 50 pF		5.3	7.5	1	8.5	ns
t <sub>PHL</sub>					5.3	7.5	1	8.5	

## 6.8 Noise Characteristics

$V_{CC} = 5\text{ V}$ ,  $C_L = 50\text{ pF}$ ,  $T_A = 25^\circ\text{C}$ <sup>1</sup>

PARAMETER		MIN	TYP	MAX	UNIT
$V_{OL(P)}$	Quiet output, maximum dynamic $V_{OL}$		0.4		V
$V_{OL(V)}$	Quiet output, minimum dynamic $V_{OL}$		-0.4		V
$V_{OH(V)}$	Quiet output, minimum dynamic $V_{OH}$		4.8		V
$V_{IH(D)}$	High-level dynamic input voltage	3.5			V
$V_{IL(D)}$	Low-level dynamic input voltage			1.5	V

(1) Characteristics are for surface-mount packages only.

## 6.9 Operating Characteristics

$V_{CC} = 5\text{ V}$ ,  $T_A = 25^\circ\text{C}$

PARAMETER		TEST CONDITIONS	TYP	UNIT
$C_{pd}$	Power dissipation capacitance	No load, $f = 1\text{ MHz}$	12	pF

## 7 Parameter Measurement Information

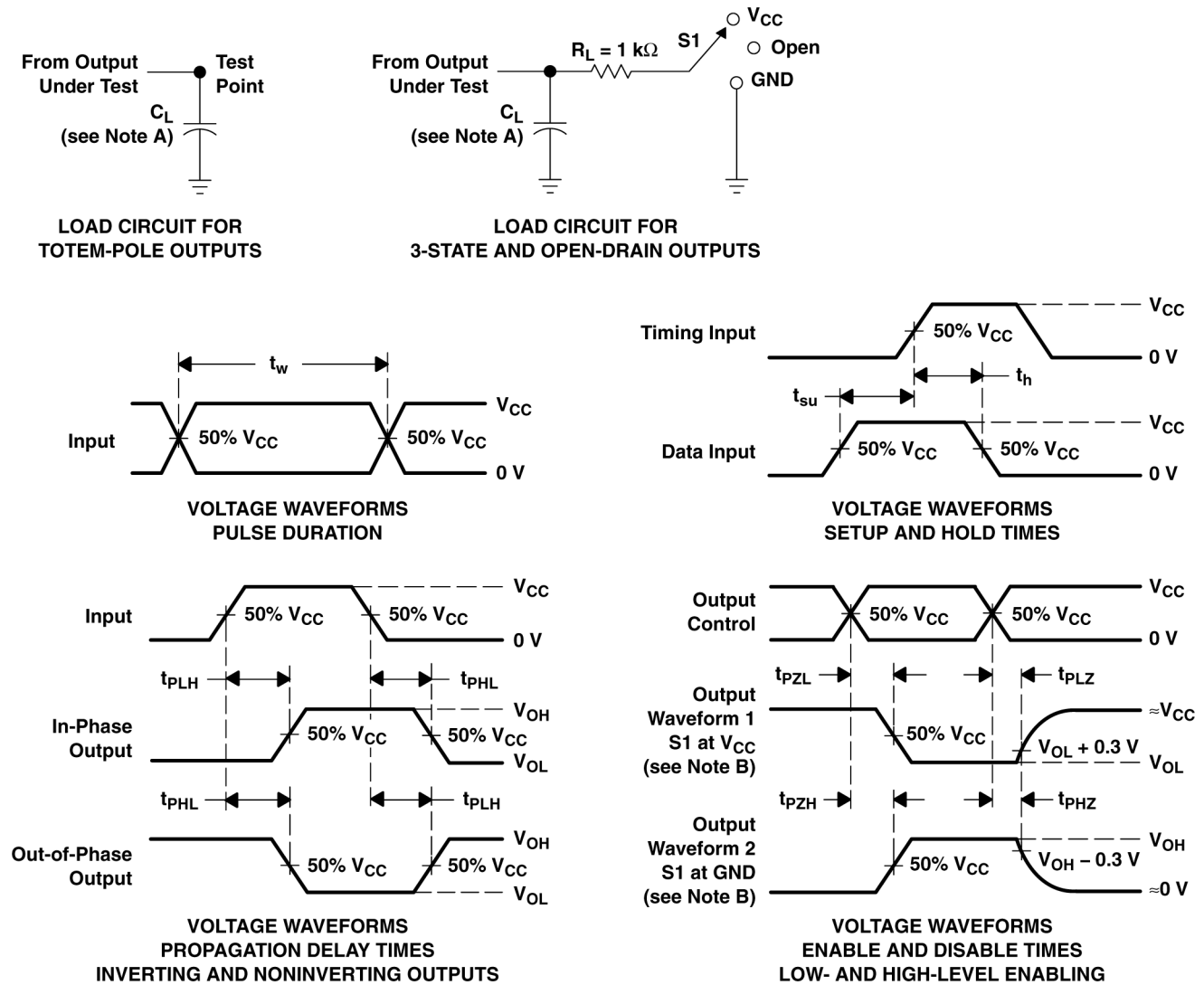

- A.  $C_L$  includes probe and jig capacitance.  
 B. Waveform 1 is for an output with internal conditions such that the output is low except when disabled by the output control. Waveform 2 is for an output with internal conditions such that the output is high except when disabled by the output control.  
 C. All input pulses are supplied by generators having the following characteristics:  $PRR \leq 1 \text{ MHz}$ ,  $Z_O = 50 \Omega$ ,  $t_r \leq 3 \text{ ns}$ ,  $t_f \leq 3 \text{ ns}$ .  
 D. The outputs are measured one at a time with one input transition per measurement.

**Figure 7-1. Load Circuit and Voltage Waveforms**

TEST	S1
$t_{PLH}/t_{PHL}$	Open
$t_{PLZ}/t_{PZL}$	$V_{CC}$
$t_{PHZ}/t_{PZH}$	GND
Open Drain	$V_{CC}$

## 8 Detailed Description

### 8.1 Functional Block Diagram

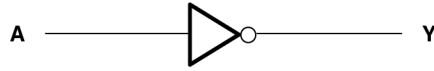

Figure 8-1. Logic Diagram, Each Inverter (Positive Logic)

### 8.2 Device Functional Modes

Table 8-1. Function Table (Each Inverter)

INPUT	OUTPUT
A	Y
H	L
L	H

## 9 Application and Implementation

### Note

Information in the following applications sections is not part of the TI component specification, and TI does not warrant its accuracy or completeness. TI's customers are responsible for determining suitability of components for their purposes, as well as validating and testing their design implementation to confirm system functionality.

### 9.1 Power Supply Recommendations

The power supply can be any voltage between the MIN and MAX supply voltage rating located in the [Recommended Operating Conditions](#) table.

Each  $V_{CC}$  pin should have a good bypass capacitor to prevent power disturbance. For devices with a single supply, 0.1  $\mu\text{F}$  is recommended. If there are multiple  $V_{CC}$  pins, 0.01  $\mu\text{F}$  or 0.022  $\mu\text{F}$  is recommended for each power pin. It is acceptable to parallel multiple bypass caps to reject different frequencies of noise. A 0.1  $\mu\text{F}$  and 1  $\mu\text{F}$  are commonly used in parallel. The bypass capacitor should be installed as close to the power pin as possible for best results.

### 9.2 Layout

#### 9.2.1 Layout Guidelines

When using multiple bit logic devices inputs should not ever float.

In many cases, functions or parts of functions of digital logic devices are unused, for example, when only two inputs of a triple-input AND gate are used or only 3 of the 4 buffer gates are used. Such input pins should not be left unconnected because the undefined voltages at the outside connections result in undefined operational states. Specified in [Layout Diagram](#) are the rules that must be observed under all circumstances. All unused inputs of digital logic devices must be connected to a high or low bias to prevent them from floating. The logic level that should be applied to any particular unused input depends on the function of the device. Generally they will be tied to GND or  $V_{CC}$ ; whichever makes more sense or is more convenient. It is generally acceptable to float outputs unless the part is a transceiver. If the transceiver has an output enable pin, it will disable the outputs section of the part when asserted. This will not disable the input section of the IOs, so they cannot float when disabled.

##### 9.2.1.1 Layout Example

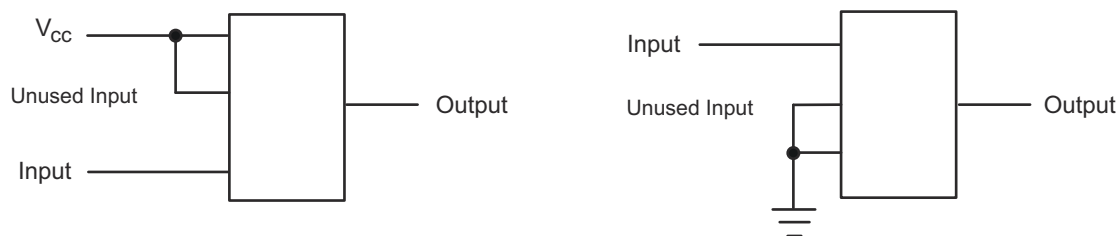

**Figure 9-1. Layout Diagram**

## 10 Device and Documentation Support

### 10.1 Document Support (Analog)

#### 10.1.1 Related Documentation

The table below lists quick access links. Categories include technical documents, support and community resources, tools and software, and quick access to sample or buy.

**Table 10-1. Related Links**

PARTS	PRODUCT FOLDER	SAMPLE & BUY	TECHNICAL DOCUMENTS	TOOLS & SOFTWARE	SUPPORT & COMMUNITY
SN74AHC04-Q1	<a href="#">Click here</a>	<a href="#">Click here</a>	<a href="#">Click here</a>	<a href="#">Click here</a>	<a href="#">Click here</a>

### 10.2 Receiving Notification of Documentation Updates

To receive notification of documentation updates, navigate to the device product folder on [ti.com](#). Click on *Subscribe to updates* to register and receive a weekly digest of any product information that has changed. For change details, review the revision history included in any revised document.

### 10.3 Support Resources

[TI E2E™ support forums](#) are an engineer's go-to source for fast, verified answers and design help — straight from the experts. Search existing answers or ask your own question to get the quick design help you need.

Linked content is provided "AS IS" by the respective contributors. They do not constitute TI specifications and do not necessarily reflect TI's views; see TI's [Terms of Use](#).

### 10.4 Trademarks

TI E2E™ is a trademark of Texas Instruments.

All trademarks are the property of their respective owners.

### 10.5 Electrostatic Discharge Caution



This integrated circuit can be damaged by ESD. Texas Instruments recommends that all integrated circuits be handled with appropriate precautions. Failure to observe proper handling and installation procedures can cause damage.

ESD damage can range from subtle performance degradation to complete device failure. Precision integrated circuits may be more susceptible to damage because very small parametric changes could cause the device not to meet its published specifications.

### 10.6 Glossary

[TI Glossary](#) This glossary lists and explains terms, acronyms, and definitions.

## 11 Mechanical, Packaging, and Orderable Information

The following pages include mechanical, packaging, and orderable information. This information is the most current data available for the designated devices. This data is subject to change without notice and revision of this document. For browser-based versions of this data sheet, refer to the left-hand navigation.

**PACKAGING INFORMATION**

Orderable Device	Status (1)	Package Type	Package Drawing	Pins	Package Qty	Eco Plan (2)	Lead finish/ Ball material (6)	MSL Peak Temp (3)	Op Temp (°C)	Device Marking (4/5)	Samples
SN74AHC04QDRG4Q1	ACTIVE	SOIC	D	14	2500	RoHS & Green	NIPDAU	Level-1-260C-UNLIM	-40 to 125	AHC04Q1	<a href="#">Samples</a>
SN74AHC04QDRQ1	ACTIVE	SOIC	D	14	2500	RoHS & Green	NIPDAU	Level-1-260C-UNLIM	-40 to 125	AHC04Q1	<a href="#">Samples</a>
SN74AHC04QPWRG4Q1	ACTIVE	TSSOP	PW	14	2000	RoHS & Green	NIPDAU	Level-1-260C-UNLIM	-40 to 125	AHC04Q1	<a href="#">Samples</a>
SN74AHC04QWBQARQ1	ACTIVE	WQFN	BQA	14	3000	RoHS & Green	NIPDAU	Level-1-260C-UNLIM	-40 to 125	AHC04Q	<a href="#">Samples</a>

(1) The marketing status values are defined as follows:

**ACTIVE:** Product device recommended for new designs.

**LIFEBUY:** TI has announced that the device will be discontinued, and a lifetime-buy period is in effect.

**NRND:** Not recommended for new designs. Device is in production to support existing customers, but TI does not recommend using this part in a new design.

**PREVIEW:** Device has been announced but is not in production. Samples may or may not be available.

**OBSELETE:** TI has discontinued the production of the device.

(2) **RoHS:** TI defines "RoHS" to mean semiconductor products that are compliant with the current EU RoHS requirements for all 10 RoHS substances, including the requirement that RoHS substance do not exceed 0.1% by weight in homogeneous materials. Where designed to be soldered at high temperatures, "RoHS" products are suitable for use in specified lead-free processes. TI may reference these types of products as "Pb-Free".

**RoHS Exempt:** TI defines "RoHS Exempt" to mean products that contain lead but are compliant with EU RoHS pursuant to a specific EU RoHS exemption.

**Green:** TI defines "Green" to mean the content of Chlorine (Cl) and Bromine (Br) based flame retardants meet JS709B low halogen requirements of <=1000ppm threshold. Antimony trioxide based flame retardants must also meet the <=1000ppm threshold requirement.

(3) MSL, Peak Temp. - The Moisture Sensitivity Level rating according to the JEDEC industry standard classifications, and peak solder temperature.

(4) There may be additional marking, which relates to the logo, the lot trace code information, or the environmental category on the device.

(5) Multiple Device Markings will be inside parentheses. Only one Device Marking contained in parentheses and separated by a "-" will appear on a device. If a line is indented then it is a continuation of the previous line and the two combined represent the entire Device Marking for that device.

(6) Lead finish/Ball material - Orderable Devices may have multiple material finish options. Finish options are separated by a vertical ruled line. Lead finish/Ball material values may wrap to two lines if the finish value exceeds the maximum column width.

**Important Information and Disclaimer:**The information provided on this page represents TI's knowledge and belief as of the date that it is provided. TI bases its knowledge and belief on information provided by third parties, and makes no representation or warranty as to the accuracy of such information. Efforts are underway to better integrate information from third parties. TI has taken and

continues to take reasonable steps to provide representative and accurate information but may not have conducted destructive testing or chemical analysis on incoming materials and chemicals. TI and TI suppliers consider certain information to be proprietary, and thus CAS numbers and other limited information may not be available for release.

In no event shall TI's liability arising out of such information exceed the total purchase price of the TI part(s) at issue in this document sold by TI to Customer on an annual basis.

**OTHER QUALIFIED VERSIONS OF SN74AHC04-Q1 :**

- Catalog : [SN74AHC04](#)
- Enhanced Product : [SN74AHC04-EP](#)
- Military : [SN54AHC04](#)

NOTE: Qualified Version Definitions:

- Catalog - TI's standard catalog product
- Enhanced Product - Supports Defense, Aerospace and Medical Applications
- Military - QML certified for Military and Defense Applications

**TAPE AND REEL INFORMATION**

**QUADRANT ASSIGNMENTS FOR PIN 1 ORIENTATION IN TAPE**

\*All dimensions are nominal

Device	Package Type	Package Drawing	Pins	SPQ	Reel Diameter (mm)	Reel Width W1 (mm)	A0 (mm)	B0 (mm)	K0 (mm)	P1 (mm)	W (mm)	Pin1 Quadrant
SN74AHC04QPWRG4Q1	TSSOP	PW	14	2000	330.0	12.4	6.9	5.6	1.6	8.0	12.0	Q1
SN74AHC04QWBQARQ1	WQFN	BQA	14	3000	180.0	12.4	2.8	3.3	1.1	4.0	12.0	Q1

**TAPE AND REEL BOX DIMENSIONS**

\*All dimensions are nominal

Device	Package Type	Package Drawing	Pins	SPQ	Length (mm)	Width (mm)	Height (mm)
SN74AHC04QPWRG4Q1	TSSOP	PW	14	2000	356.0	356.0	35.0
SN74AHC04QWBQARQ1	WQFN	BQA	14	3000	210.0	185.0	35.0





PW (R-PDSO-G14)

PLASTIC SMALL OUTLINE



4211284-2/G 08/15

- NOTES:
- All linear dimensions are in millimeters.
  - This drawing is subject to change without notice.
  - Publication IPC-7351 is recommended for alternate designs.
  - Laser cutting apertures with trapezoidal walls and also rounding corners will offer better paste release. Customers should contact their board assembly site for stencil design recommendations. Refer to IPC-7525 for other stencil recommendations.
  - Customers should contact their board fabrication site for solder mask tolerances between and around signal pads.

## GENERIC PACKAGE VIEW

**BQA 14**

**WQFN - 0.8 mm max height**

2.5 x 3, 0.5 mm pitch

PLASTIC QUAD FLATPACK - NO LEAD

This image is a representation of the package family, actual package may vary.  
Refer to the product data sheet for package details.

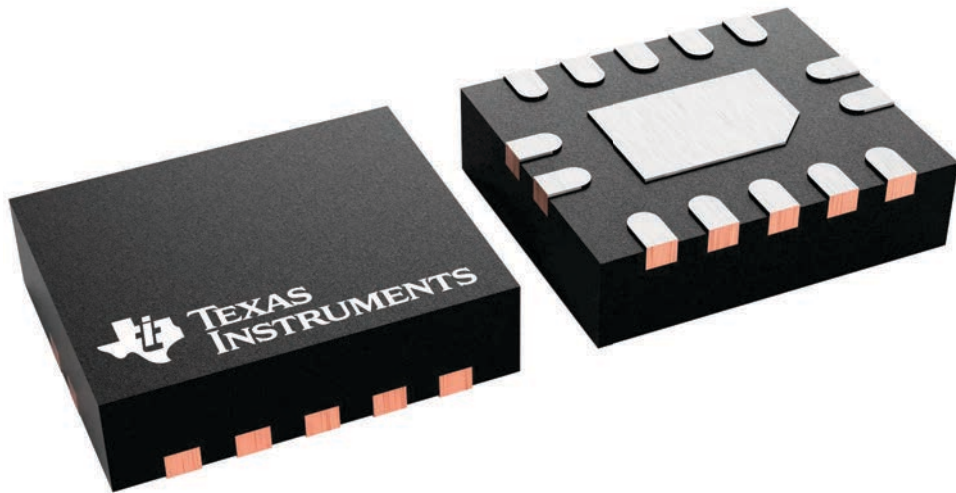

4227145/A

# BQA0014B

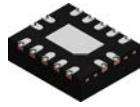

# PACKAGE OUTLINE

## WQFN - 0.8 mm max height

PLASTIC QUAD FLATPACK - NO LEAD

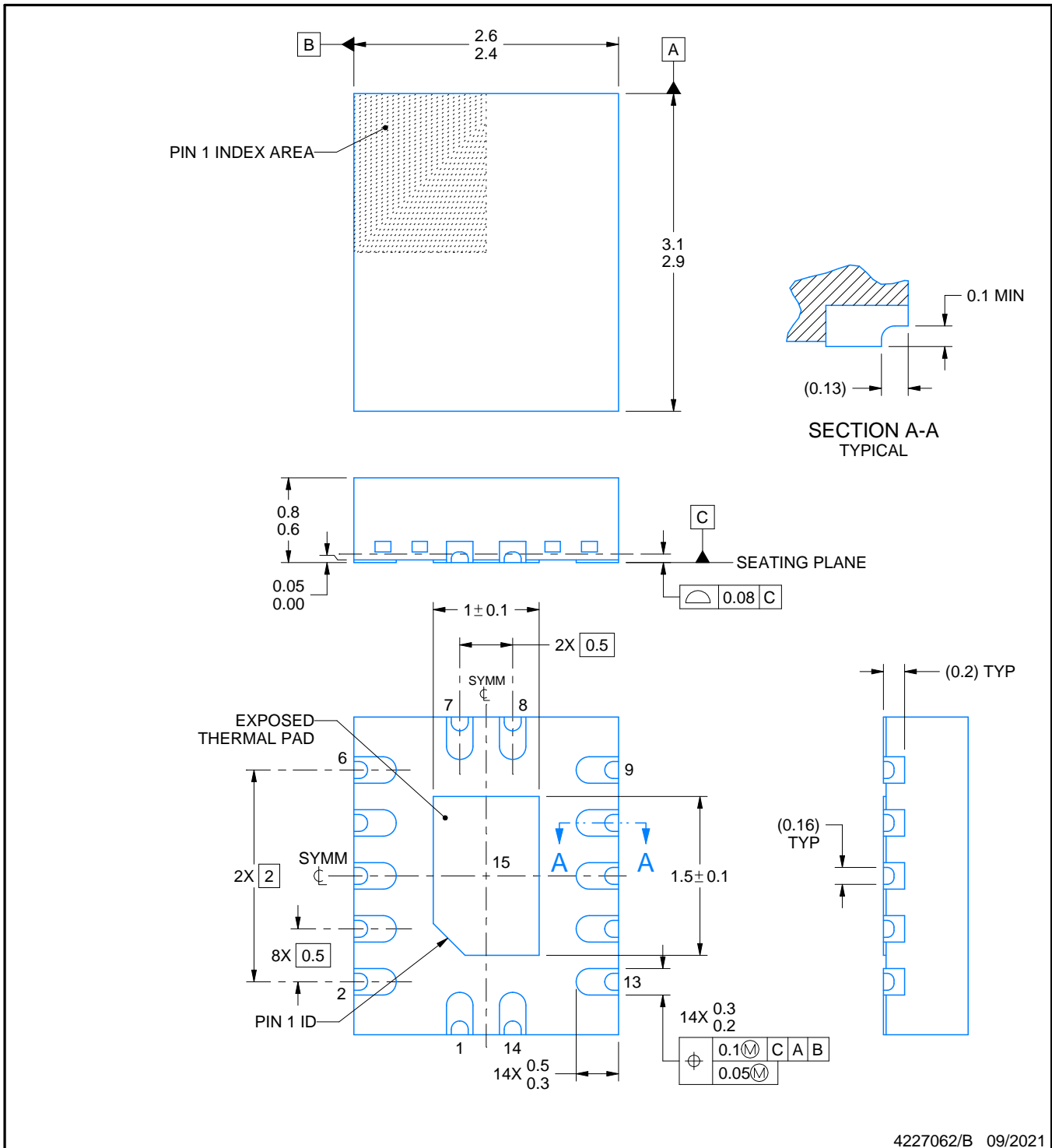

**NOTES:**

1. All linear dimensions are in millimeters. Any dimensions in parenthesis are for reference only. Dimensioning and tolerancing per ASME Y14.5M.
2. This drawing is subject to change without notice.
3. The package thermal pad must be soldered to the printed circuit board for thermal and mechanical performance.

# EXAMPLE BOARD LAYOUT

**BQA0014B**

**WQFN - 0.8 mm max height**

PLASTIC QUAD FLATPACK - NO LEAD

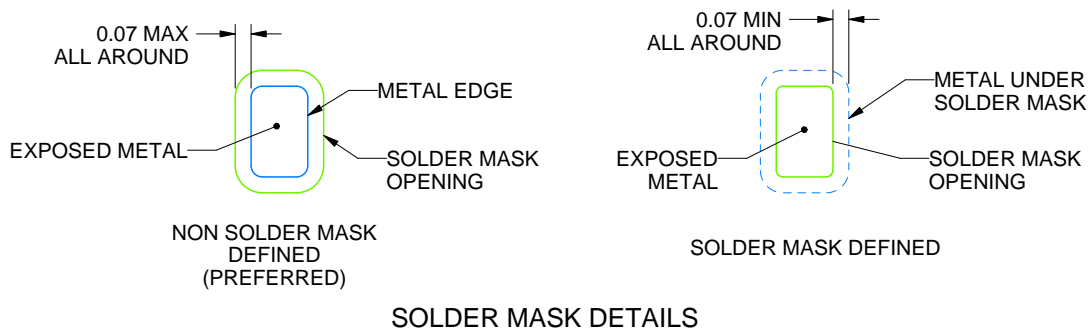
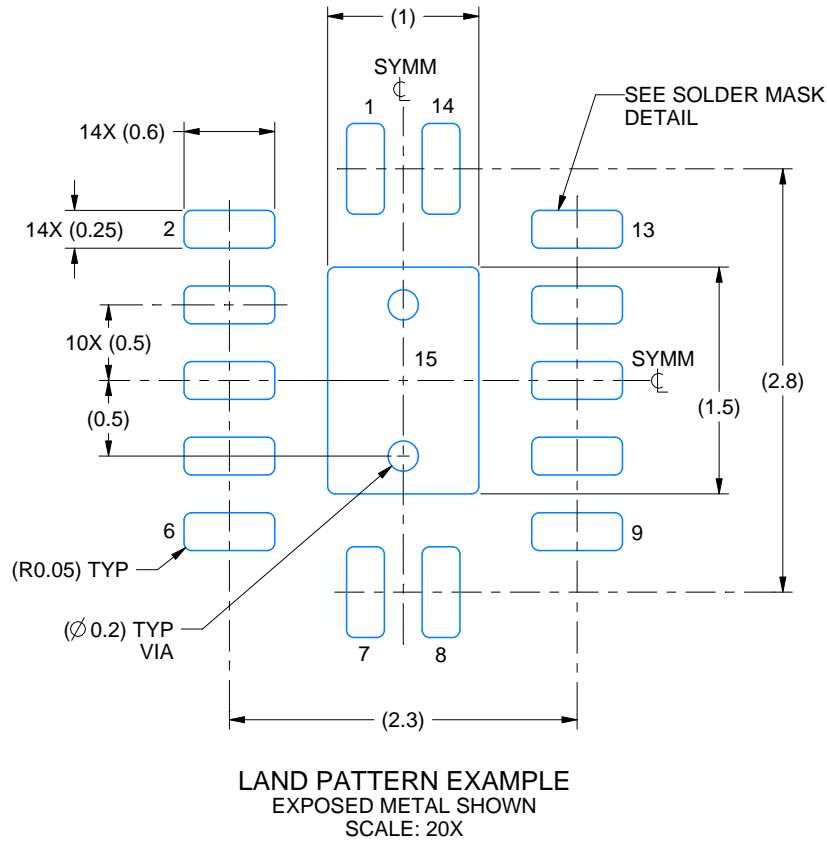

4227062/B 09/2021

NOTES: (continued)

4. This package is designed to be soldered to a thermal pad on the board. For more information, see Texas Instruments literature number SLUA271 ([www.ti.com/lit/sluea271](http://www.ti.com/lit/sluea271)).
5. Vias are optional depending on application, refer to device data sheet. If any vias are implemented, refer to their locations shown on this view. It is recommended that vias under paste be filled, plugged or tented.

# EXAMPLE STENCIL DESIGN

BQA0014B

WQFN - 0.8 mm max height

PLASTIC QUAD FLATPACK - NO LEAD

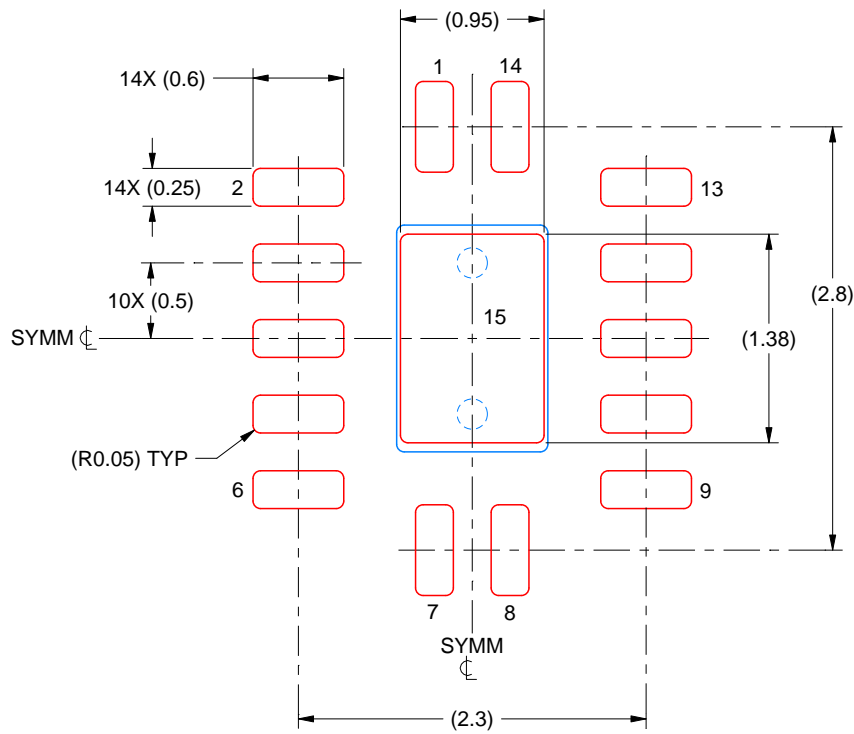

SOLDER PASTE EXAMPLE  
BASED ON 0.125 MM THICK STENCIL  
SCALE: 20X

EXPOSED PAD 15  
87% PRINTED SOLDER COVERAGE BY AREA UNDER PACKAGE

4227062/B 09/2021

NOTES: (continued)

6. Laser cutting apertures with trapezoidal walls and rounded corners may offer better paste release. IPC-7525 may have alternate design recommendations.

## IMPORTANT NOTICE AND DISCLAIMER

TI PROVIDES TECHNICAL AND RELIABILITY DATA (INCLUDING DATA SHEETS), DESIGN RESOURCES (INCLUDING REFERENCE DESIGNS), APPLICATION OR OTHER DESIGN ADVICE, WEB TOOLS, SAFETY INFORMATION, AND OTHER RESOURCES "AS IS" AND WITH ALL FAULTS, AND DISCLAIMS ALL WARRANTIES, EXPRESS AND IMPLIED, INCLUDING WITHOUT LIMITATION ANY IMPLIED WARRANTIES OF MERCHANTABILITY, FITNESS FOR A PARTICULAR PURPOSE OR NON-INFRINGEMENT OF THIRD PARTY INTELLECTUAL PROPERTY RIGHTS.

These resources are intended for skilled developers designing with TI products. You are solely responsible for (1) selecting the appropriate TI products for your application, (2) designing, validating and testing your application, and (3) ensuring your application meets applicable standards, and any other safety, security, regulatory or other requirements.

These resources are subject to change without notice. TI grants you permission to use these resources only for development of an application that uses the TI products described in the resource. Other reproduction and display of these resources is prohibited. No license is granted to any other TI intellectual property right or to any third party intellectual property right. TI disclaims responsibility for, and you will fully indemnify TI and its representatives against, any claims, damages, costs, losses, and liabilities arising out of your use of these resources.

TI's products are provided subject to [TI's Terms of Sale](#) or other applicable terms available either on [ti.com](https://www.ti.com) or provided in conjunction with such TI products. TI's provision of these resources does not expand or otherwise alter TI's applicable warranties or warranty disclaimers for TI products.

TI objects to and rejects any additional or different terms you may have proposed.

Mailing Address: Texas Instruments, Post Office Box 655303, Dallas, Texas 75265  
Copyright © 2023, Texas Instruments Incorporated

## Looking for pricing, stock, or lifecycle information?

Click below to explore more details on WIN SOURCE:

 [View SN74AHC04QPWRQ1 on WIN SOURCE](#)

 [Texas Instruments](#) Information

## Optimize Your Supply Chain with WIN SOURCE Solutions

-  Global Sourcing Solution
-  Obsolete Management
-  Cost Control Management
-  Shortage Management
-  Alternative Solution
-  Excess Inventory Management