



**THE DATASHEET OF
SLG5NT1594V**





General Description

The SLG5NT1594V is designed for load switching applications with ultra low quiescent current. The part comes with one 28.5 mΩ 1.0 A rated P-channel MOSFET controlled by a single ON control pin. The product is packaged in an ultra-small 1.0 x 1.0 mm package.

Features

- One 1.0 A MOSFET
- Ultra Low Quiescent Current
- Low RDSON
 - 28.5 mΩ @ 5.0 V
 - 36.4 mΩ @ 3.3 V
 - 44.3 mΩ @ 2.5 V
 - 60.8 mΩ @ 1.8 V
 - 77.6 mΩ @ 1.5 V
- $V_{IN} = 1.5\text{ V to }5.5\text{ V}$
- Pb-Free / Halogen-Free / RoHS compliant
- STDFN 4L, 1.0 x 1.0 x 0.55 mm

Pin Configuration

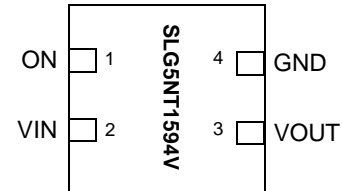

4-pin STDFN
(Top View)

Block Diagram

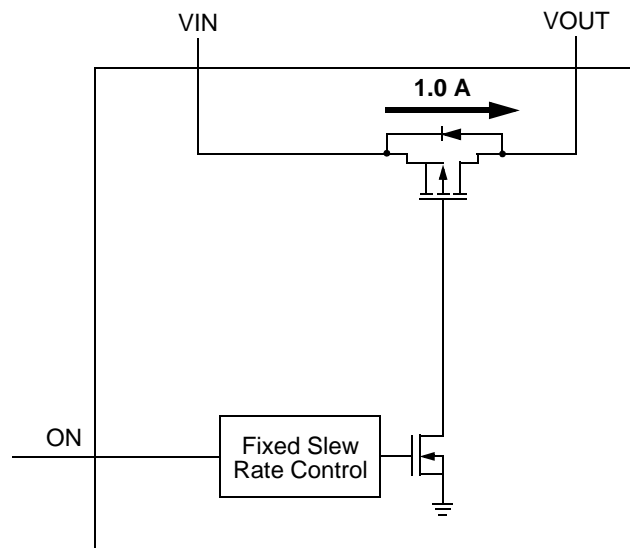



Pin Description

Pin #	Pin Name	Type	Pin Description
1	ON	Input	Turns on MOSFET.
2	VIN	MOSFET	Power MOSFET input
3	VOUT	MOSFET	Power MOSFET output
4	GND	GND	Ground

Ordering Information

Part Number	Type	Production Flow
SLG5NT1594V	STDFN 4L	Industrial, -40 °C to 85 °C
SLG5NT1594VTR	STDFN 4L (Tape and Reel)	Industrial, -40 °C to 85 °C



Absolute Maximum Ratings

Parameter	Description	Conditions	Min.	Typ.	Max.	Unit
V_{IN}	Power Supply		--	--	6	V
T_S	Storage Temperature		-65	--	140	°C
ESD_{HBM}	ESD Protection	Human Body Model	2000	--	--	V
W_{DIS}	Package Power Dissipation		--	--	0.5	W
MOSFET IDS_{PK}	Peak Current from Drain to Source	For no more than 1 ms with 1% duty cycle	--	--	1.5	A

Note: Stresses greater than those listed under "Absolute Maximum Ratings" may cause permanent damage to the device. This is a stress rating only and functional operation of the device at these or any other conditions above those indicated in the operational sections of this specification is not implied. Exposure to absolute maximum rating conditions for extended periods may affect reliability.

Electrical Characteristics

$T_A = -40\text{ °C to }85\text{ °C}$ (unless otherwise stated)

Parameter	Description	Conditions	Min.	Typ.	Max.	Unit
V_{IN}	Power Supply Voltage	-40 °C to 85 °C	1.5	--	5.5	V
I_{DD}	Power Supply Current (PIN 2)	when OFF, $V_{IN} = 5.5\text{ V}$, No load	--	0.02	1	μA
		when ON = V_{IN} , No load	--	0.05	0.5	μA
I_{ON_LKG}	ON Pin Input Leakage		--	--	0.1	μA
RDS_{ON}	Static Drain to Source ON Resistance @ $T_A\ 25\text{ °C}$	@ 5.5 V	--	28.5	32.0	mΩ
		@ 3.3 V	--	36.4	40.0	mΩ
		@ 2.5 V	--	44.3	49.0	mΩ
		@ 1.8 V	--	60.8	65.0	mΩ
		@ 1.5 V	--	77.6	82.0	mΩ
RDS_{ON}	Static Drain to Source ON Resistance @ $T_A\ 85\text{ °C}$	@ 5.5 V	--	34.0	36.0	mΩ
		@ 3.3 V	--	43.8	46.0	mΩ
		@ 2.5 V	--	53.3	56.0	mΩ
		@ 1.8 V	--	72.2	76.0	mΩ
		@ 1.5 V	--	90.7	94.0	mΩ
IDS	Operating Current	$V_{IN} = 1.5\text{ V to }5.5\text{ V}$	--	--	1.0	A
T_{ON_Delay}	ON pin Delay Time	50% ON to Ramp Begin $V_{IN} = 5\text{ V}$, $V_{OUT_Cap} = 0.1\ \mu\text{F}$, $R_L = 10\ \Omega$	10	15	27	μs
		50% ON to Ramp Begin $V_{IN} = 3.3\text{ V}$, $V_{OUT_Cap} = 0.1\ \mu\text{F}$, $R_L = 10\ \Omega$	17	31	40	μs
		50% ON to Ramp Begin $V_{IN} = 1.5\text{ V}$, $V_{OUT_Cap} = 0.1\ \mu\text{F}$, $R_L = 10\ \Omega$	44	69	96	μs
T_{Total_ON}	Total Turn On Time	50% ON to 90% V_{OUT} $V_{IN} = 5\text{ V}$, $V_{OUT_Cap} = 0.1\ \mu\text{F}$, $R_L = 10\ \Omega$	114	122	134	μs
		50% ON to 90% V_{OUT} $V_{IN} = 3.3\text{ V}$, $V_{OUT_Cap} = 0.1\ \mu\text{F}$, $R_L = 10\ \Omega$	146	156	176	μs
		50% ON to 90% V_{OUT} $V_{IN} = 1.5\text{ V}$, $V_{OUT_Cap} = 0.1\ \mu\text{F}$, $R_L = 10\ \Omega$	292	332	399	μs



T_A = -40 °C to 85 °C (unless otherwise stated)

Parameter	Description	Conditions	Min.	Typ.	Max.	Unit
T _{RISE}	Rise Time	10% VOUT to 90% VOUT V _{IN} = 5.0 V, VOUT_Cap = 0.1 μF, R _L = 10 Ω	92	97	107	μs
		10% VOUT to 90% VOUT V _{IN} = 3.3 V, VOUT_Cap = 0.1 μF, R _L = 10 Ω	116	120	131	μs
		10% VOUT to 90% VOUT V _{IN} = 1.5 V, VOUT_Cap = 0.1 μF, R _L = 10 Ω	228	253	296	μs
ON_V _{IH}	Initial Turn On Voltage		0.85	--	V _{IN}	V
ON_V _{IL}	Low Input Voltage on ON pin		-0.3	0	0.3	V
T _{Delay_OFF}	OFF Delay Time	50% ON to V _{OUT} Fall, V _{IN} = 5 V, R _L = 10 Ω	6.2	6.5	7.0	μs



VIN vs. Max IDS, Safe Operation Area

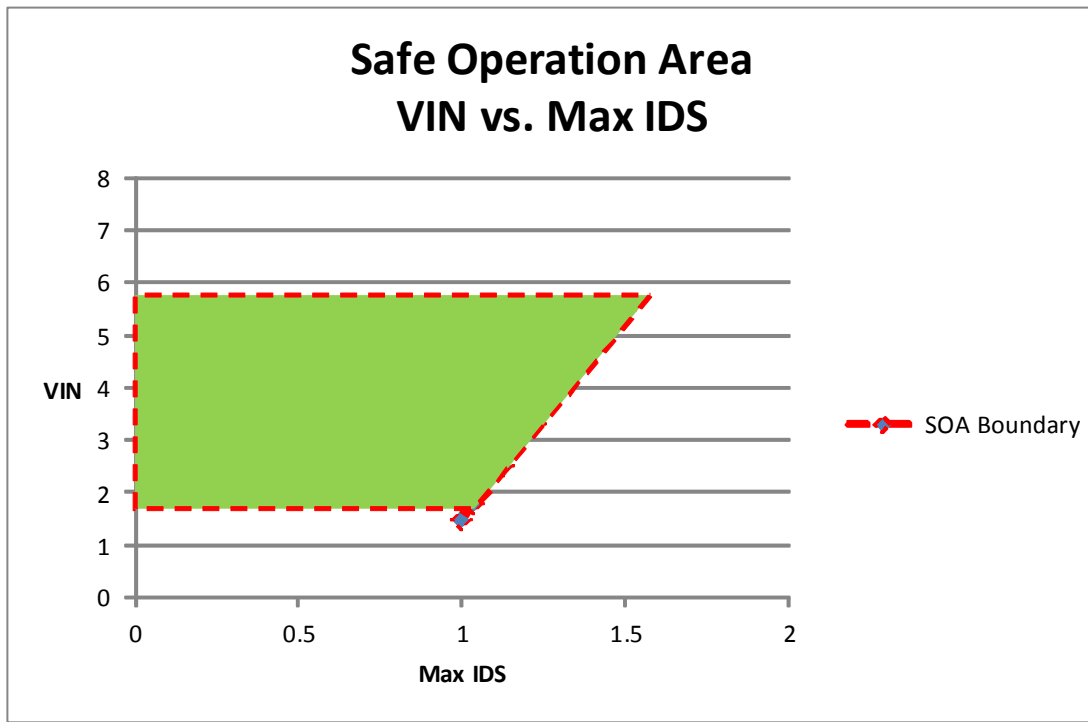

T_{Total_ON} , T_{ON_Delay} and Slew Rate Measurement

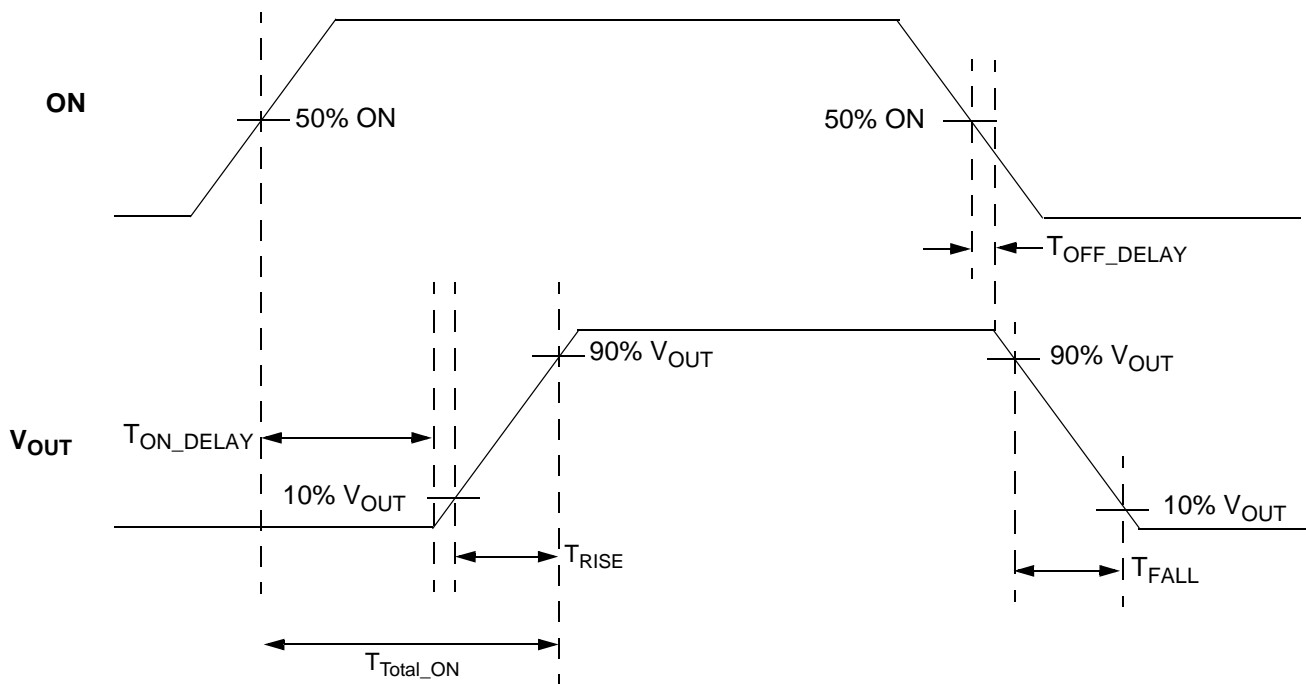



SLG5NT1594V Power-Up/Power-Down Sequence Considerations

A nominal power-up sequence is to apply VIN and toggle the ON pin LOW-to-HIGH after VIN is at least 90% of its final value. A nominal power-down sequence is the power-up sequence in reverse order. If VIN ramp is too fast, a voltage glitch may appear on the output pin at VOUT. To prevent glitches at the output, it is recommended to connect at least 0.1uF capacitor from the VOUT pin to GND and to keep the VIN ramp time less than 2 ms.

SLG5NT1594V Layout Suggestion

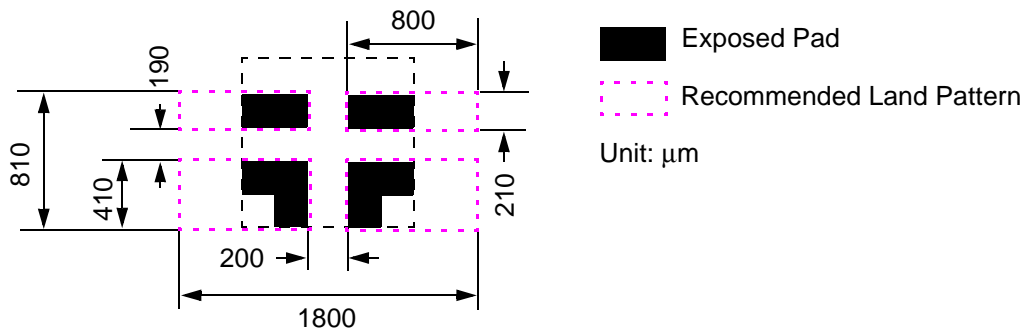



Package Top Marking System Definition

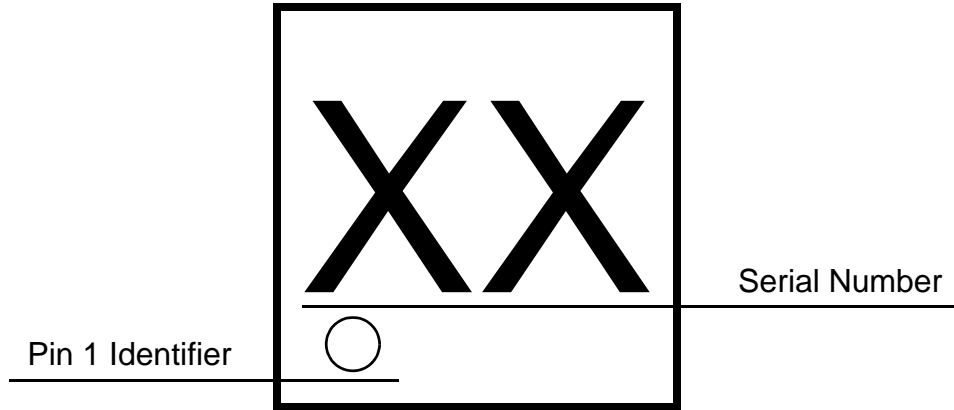



Package Drawing and Dimensions

4 Lead STDFN Package 1.0 x 1.0 mm

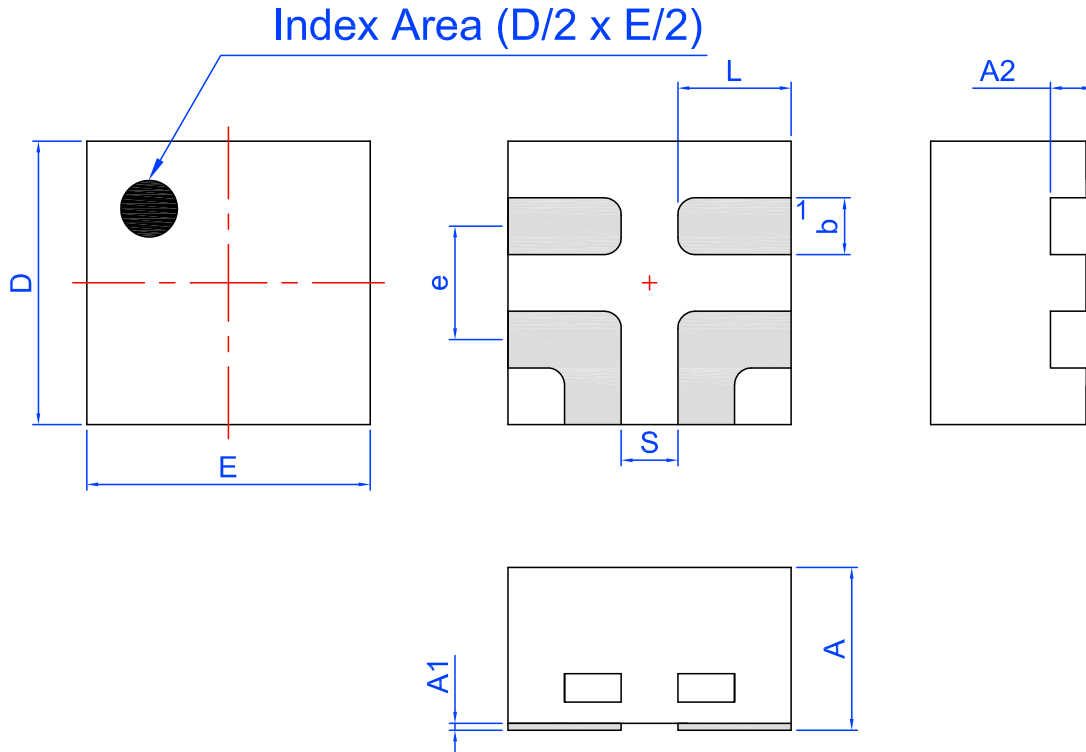

Unit: mm

Symbol	Min	Nom.	Max	Symbol	Min	Nom.	Max
A	0.50	0.55	0.60	D	0.95	1.00	1.05
A1	0.005	-	0.060	E	0.95	1.00	1.05
A2	0.10	0.15	0.20	L	0.35	0.40	0.45
b	0.15	0.20	0.25	S	0.2 REF		
e	0.40 BSC						



Tape and Reel Specifications

Package Type	# of Pins	Nominal Package Size [mm]	Max Units		Reel & Hub Size [mm]	Leader (min)		Trailer (min)		Tape Width [mm]	Part Pitch [mm]
			per Reel	per Box		Pockets	Length [mm]	Pockets	Length [mm]		
STDFN 4L 1x1mm 0.4P FC Green	4	1.0 x 1.0 x 0.55	8000	8000	178 / 60	200	400	200	400	8	2

Carrier Tape Drawing and Dimensions

Package Type	Pocket BTM Length	Pocket BTM Width	Pocket Depth	Index Hole Pitch	Pocket Pitch	Index Hole Diameter	Index Hole to Tape Edge	Index Hole to Pocket Center	Tape Width
	A0	B0	K0	P0	P1	D0	E	F	W
STDFN 4L 1x1mm 0.4P FC Green	1.16	1.16	0.63	4	2	1.5	1.75	3.5	8

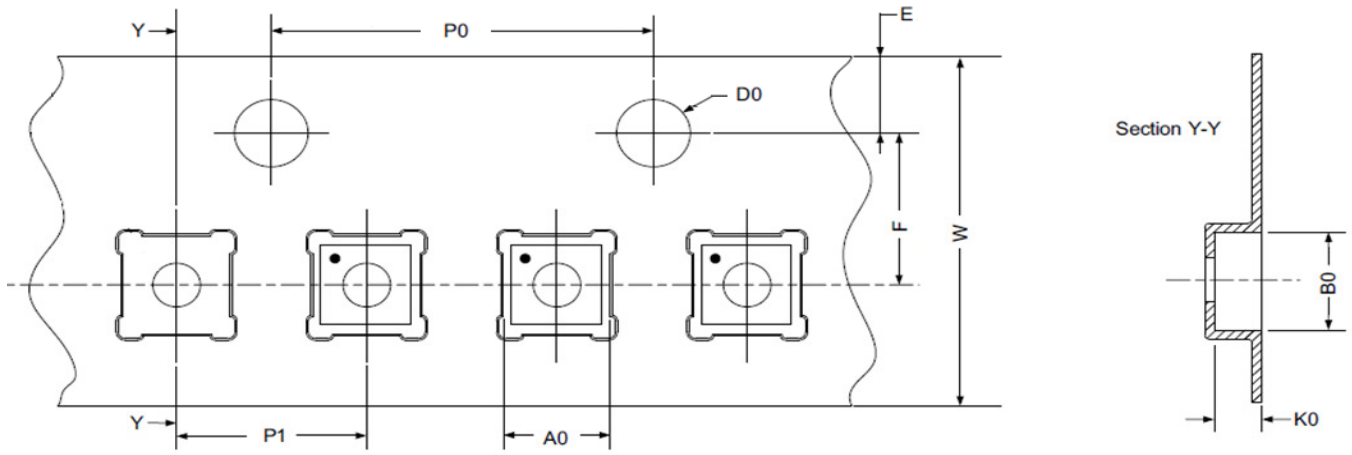

Refer to EIA-481 specification

Recommended Reflow Soldering Profile

Please see IPC/JEDEC J-STD-020: latest revision for reflow profile based on package volume of 0.55 mm³ (nominal). More information can be found at www.jedec.org.





Revision History

Date	Version	Change
12/29/2016	1.00	Production Release

Looking for pricing, stock, or lifecycle information?

Click below to explore more details on WIN SOURCE:

-  [View SLG5NT1594V on WIN SOURCE](#)
-  [Dialog Semiconductor GmbH Information](#)

Optimize Your Supply Chain with WIN SOURCE Solutions

-  Global Sourcing Solution
-  Obsolete Management
-  Cost Control Management
-  Shortage Management
-  Alternative Solution
-  Excess Inventory Management