



**THE DATASHEET OF
SI8420BD-A-ISR**



LOW-POWER, SINGLE AND DUAL-CHANNEL DIGITAL ISOLATORS

Features

- High-speed operation
 - DC to 150 Mbps
- No start-up initialization required
- Wide Operating Supply Voltage: 2.6–5.5 V
- Up to 5000 V_{RMS} isolation
- High electromagnetic immunity
- Ultra low power (typical) 5 V Operation:
 - < 2.6 mA/channel at 1 Mbps
 - < 6.8 mA/channel at 100 Mbps
- 2.70 V Operation:
 - < 2.3 mA/channel at 1 Mbps
 - < 4.6 mA/channel at 100 Mbps
- Schmitt trigger inputs
- Selectable fail-safe mode
 - Default high or low output
- Precise timing (typical)
 - 11 ns propagation delay max
 - 1.5 ns pulse width distortion
 - 0.5 ns channel-channel skew
 - 2 ns propagation delay skew
 - 5 ns minimum pulse width
- Transient immunity 45 kV/μs
- Wide temperature range
 - –40 to 125 °C at 150 Mbps
- RoHS compliant packages
 - SOIC-16 wide body
 - SOIC-8 narrow body

Applications

- Industrial automation systems
- Medical electronics
- Hybrid electric vehicles
- Isolated switch mode supplies
- Isolated ADC, DAC
- Motor control
- Power inverters
- Communication systems

Safety Regulatory Approvals

- UL 1577 recognized
 - Up to 5000 V_{RMS} for 1 minute
- CSA component notice 5A approval
 - IEC 60950-1, 61010-1, 60601-1 (reinforced insulation)
- VDE certification conformity
 - IEC 60747-5-2 (VDE0884 Part 2)
 - EN60950-1 (reinforced insulation)

Description

Silicon Lab's family of ultra-low-power digital isolators are CMOS devices offering substantial data rate, propagation delay, power, size, reliability, and external BOM advantages when compared to legacy isolation technologies. The operating parameters of these products remain stable across wide temperature ranges and throughout device service life for ease of design and highly uniform performance. All device versions have Schmitt trigger inputs for high noise immunity and only require V_{DD} bypass capacitors.

Data rates up to 150 Mbps are supported, and all devices achieve worst-case propagation delays of less than 10 ns. Ordering options include a choice of isolation ratings (up to 5 kV) and a selectable fail-safe operating mode to control the default output state during power loss. All products are safety certified by UL, CSA, and VDE, and products in wide-body packages support reinforced insulation withstanding up to 5 kV_{RMS}.

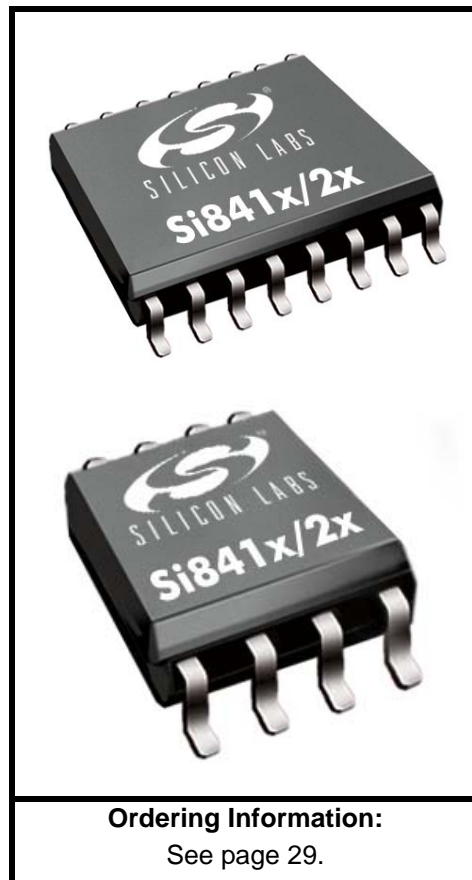

TABLE OF CONTENTS

<u>Section</u>	<u>Page</u>
1. Electrical Specifications	4
2. Functional Description	20
2.1. Theory of Operation	20
2.2. Eye Diagram	21
3. Device Operation	22
3.1. Device Startup	23
3.2. Under Voltage Lockout	23
3.3. Layout Recommendations	24
3.4. Fail-Safe Operating Mode	24
3.5. Typical Performance Characteristics	25
4. Pin Descriptions (Wide-Body SOIC)	27
5. Pin Descriptions (Narrow-Body SOIC)	28
6. Ordering Guide	29
7. Package Outline: 16-Pin Wide Body SOIC	30
8. Land Pattern: 16-Pin Wide-Body SOIC	31
9. Package Outline: 8-Pin Narrow Body SOIC	32
10. Land Pattern: 8-Pin Narrow Body SOIC	33
11. Top Marking: 16-Pin Wide Body SOIC	34
12. Top Marking: 8-Pin Narrow-Body SOIC	35
Document Change List	36
Contact Information	38

Si8410/20/21 (5 kV) Si8422/23 (2.5 & 5 kV)

1. Electrical Specifications

Table 1. Electrical Characteristics

($V_{DD1} = 5\text{ V} \pm 10\%$, $V_{DD2} = 5\text{ V} \pm 10\%$, $T_A = -40$ to $125\text{ }^\circ\text{C}$)

Parameter	Symbol	Test Condition	Min	Typ	Max	Unit
VDD Undervoltage Threshold	VDDUV+	V_{DD1} , V_{DD2} rising	2.15	2.3	2.5	V
VDD Negative-Going Lockout Hysteresis	VDDHYS		45	75	95	mV
Positive-Going Input Threshold	VT+	All inputs rising	1.6	—	1.9	V
Negative-Going Input Threshold	VT-	All inputs falling	1.1	—	1.4	V
Input Hysteresis	V _{HYS}		0.40	0.45	0.50	V
High Level Input Voltage	V _{IH}		2.0	—	—	V
Low Level Input Voltage	V _{IL}		—	—	0.8	V
High Level Output Voltage	V _{OH}	loh = -4 mA	$V_{DD1}, V_{DD2} - 0.4$	4.8	—	V
Low Level Output Voltage	V _{OL}	lol = 4 mA	—	0.2	0.4	V
Input Leakage Current	I _L		—	—	±10	µA
Output Impedance ¹	Z _O		—	50	—	Ω
DC Supply Current (All inputs 0 V or at Supply)						
Si8410Ax, Bx						
V_{DD1}		All inputs 0 DC	—	1.0	1.5	mA
V_{DD2}		All inputs 0 DC	—	1.0	1.5	
V_{DD1}		All inputs 1 DC	—	3.0	4.5	
V_{DD2}		All inputs 1 DC	—	1.0	1.5	
Si8420Ax, Bx						
V_{DD1}		All inputs 0 DC	—	1.3	2.0	mA
V_{DD2}		All inputs 0 DC	—	1.7	2.6	
V_{DD1}		All inputs 1 DC	—	5.8	8.7	
V_{DD2}		All inputs 1 DC	—	1.7	2.6	
Si8421Ax, Bx						
V_{DD1}		All inputs 0 DC	—	1.7	2.6	mA
V_{DD2}		All inputs 0 DC	—	1.7	2.6	
V_{DD1}		All inputs 1 DC	—	3.7	5.6	
V_{DD2}		All inputs 1 DC	—	3.7	5.6	
Si8422Ax, Bx						
V_{DD1}		All inputs 0 DC	—	3.7	5.6	mA
V_{DD2}		All inputs 0 DC	—	3.7	5.6	
V_{DD1}		All inputs 1 DC	—	1.7	2.6	
V_{DD2}		All inputs 1 DC	—	1.7	2.6	
Si8423Ax, Bx						
V_{DD1}		All inputs 0 DC	—	5.4	8.1	mA
V_{DD2}		All inputs 0 DC	—	1.7	2.6	
V_{DD1}		All inputs 1 DC	—	1.3	2.0	
V_{DD2}		All inputs 1 DC	—	1.7	2.6	
Notes:						
1. The nominal output impedance of an isolator driver channel is approximately 50 Ω, ±40%, which is a combination of the value of the on-chip series termination resistor and channel resistance of the output driver FET. When driving loads where transmission line effects will be a factor, output pins should be appropriately terminated with controlled impedance PCB traces.						
2. $t_{PSK(P-P)}$ is the magnitude of the difference in propagation delay times measured between different units operating at the same supply voltages, load, and ambient temperature.						
3. Start-up time is the time period from the application of power to valid data at the output.						

Si8410/20/21 (5 kV) Si8422/23 (2.5 & 5 kV)

Table 1. Electrical Characteristics (Continued)

($V_{DD1} = 5\text{ V} \pm 10\%$, $V_{DD2} = 5\text{ V} \pm 10\%$, $T_A = -40\text{ to }125\text{ }^\circ\text{C}$)

Parameter	Symbol	Test Condition	Min	Typ	Max	Unit
1 Mbps Supply Current (All inputs = 500 kHz square wave, $C_L = 15\text{ pF}$ on all outputs)						
Si8410Ax, Bx						
V_{DD1}			—	2.0	3.0	mA
V_{DD2}			—	1.1	1.7	
Si8420Ax, Bx						
V_{DD1}			—	3.5	5.3	mA
V_{DD2}			—	1.9	2.9	
Si8421Ax, Bx						
V_{DD1}			—	2.8	4.2	mA
V_{DD2}			—	2.8	4.2	
Si8422Ax, Bx						
V_{DD1}			—	2.8	4.2	mA
V_{DD2}			—	2.8	4.2	
Si8423Ax, Bx						
V_{DD1}			—	3.4	5.1	mA
V_{DD2}			—	1.9	2.9	
10 Mbps Supply Current (All inputs = 5 MHz square wave, $C_L = 15\text{ pF}$ on all outputs)						
Si8410Bx						
V_{DD1}			—	2.1	3.1	mA
V_{DD2}			—	1.5	2.1	
Si8420Bx						
V_{DD1}			—	3.6	5.4	mA
V_{DD2}			—	2.6	3.6	
Si8421Bx						
V_{DD1}			—	3.2	4.5	mA
V_{DD2}			—	3.2	4.5	
Si8422Bx						
V_{DD1}			—	3.2	4.5	mA
V_{DD2}			—	3.2	4.5	
Si8423Bx						
V_{DD1}			—	3.4	5.1	mA
V_{DD2}			—	2.5	3.5	
Notes:						
<ol style="list-style-type: none"> The nominal output impedance of an isolator driver channel is approximately $50\ \Omega$, $\pm 40\%$, which is a combination of the value of the on-chip series termination resistor and channel resistance of the output driver FET. When driving loads where transmission line effects will be a factor, output pins should be appropriately terminated with controlled impedance PCB traces. $t_{PSK(P-P)}$ is the magnitude of the difference in propagation delay times measured between different units operating at the same supply voltages, load, and ambient temperature. Start-up time is the time period from the application of power to valid data at the output. 						

Si8410/20/21 (5 kV)

Si8422/23 (2.5 & 5 kV)

Table 1. Electrical Characteristics (Continued)

($V_{DD1} = 5\text{ V} \pm 10\%$, $V_{DD2} = 5\text{ V} \pm 10\%$, $T_A = -40$ to $125\text{ }^\circ\text{C}$)

Parameter	Symbol	Test Condition	Min	Typ	Max	Unit
100 Mbps Supply Current (All inputs = 50 MHz square wave, $C_L = 15\text{ pF}$ on all outputs)						
Si8410Bx						
V_{DD1}			—	2.1	3.1	mA
V_{DD2}			—	5.0	6.3	
Si8420Bx						
V_{DD1}			—	3.7	5.4	mA
V_{DD2}			—	9.8	12.3	
Si8421Bx						
V_{DD1}			—	6.8	8.5	mA
V_{DD2}			—	6.8	8.5	
Si8422Bx						
V_{DD1}			—	6.8	8.5	mA
V_{DD2}			—	6.8	8.5	
Si8423Bx						
V_{DD1}			—	3.4	5.1	mA
V_{DD2}			—	9.2	11.5	
Timing Characteristics						
Si841xAx, Si842xAx						
Maximum Data Rate			0	—	1.0	Mbps
Minimum Pulse Width			—	—	250	ns
Propagation Delay	t_{PHL}, t_{PLH}	See Figure 1	—	—	35	ns
Pulse Width Distortion $ t_{PLH} - t_{PHL} $	PWD	See Figure 1	—	—	25	ns
Propagation Delay Skew ²	$t_{PSK(P-P)}$		—	—	40	ns
Channel-Channel Skew	t_{PSK}		—	—	35	ns
Si841xBx, Si842xBx						
Maximum Data Rate			0	—	150	Mbps
Minimum Pulse Width			—	—	6.0	ns
Propagation Delay	t_{PHL}, t_{PLH}	See Figure 1	4.0	8.0	11	ns
Pulse Width Distortion $ t_{PLH} - t_{PHL} $	PWD	See Figure 1	—	1.5	3.0	ns
Propagation Delay Skew ²	$t_{PSK(P-P)}$		—	2.0	3.0	ns
Channel-Channel Skew	t_{PSK}		—	0.5	1.5	ns
All Models						
Output Rise Time	t_r	$C_L = 15\text{ pF}$	—	2.0	4.0	ns
Output Fall Time	t_f	$C_L = 15\text{ pF}$	—	2.0	4.0	ns
Peak Eye Diagram Jitter	$t_{JIT(PK)}$	See Figure 6	—	350	—	ps
Common Mode Transient Immunity	CMTI	$V_I = V_{DD}$ or 0 V	20	45	—	kV/ μs
Start-up Time ³	t_{SU}		—	15	40	μs
Notes:						
<ol style="list-style-type: none"> The nominal output impedance of an isolator driver channel is approximately $50\ \Omega$, $\pm 40\%$, which is a combination of the value of the on-chip series termination resistor and channel resistance of the output driver FET. When driving loads where transmission line effects will be a factor, output pins should be appropriately terminated with controlled impedance PCB traces. $t_{PSK(P-P)}$ is the magnitude of the difference in propagation delay times measured between different units operating at the same supply voltages, load, and ambient temperature. Start-up time is the time period from the application of power to valid data at the output. 						

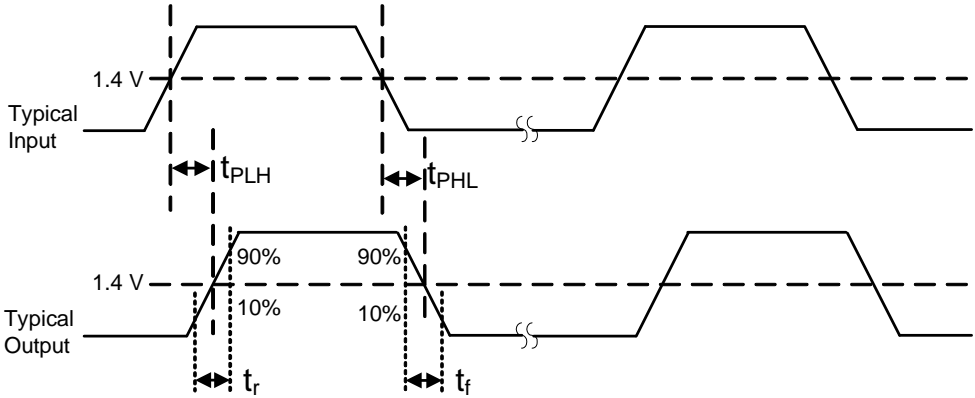

Figure 1. Propagation Delay Timing

Si8410/20/21 (5 kV)

Si8422/23 (2.5 & 5 kV)

Table 2. Electrical Characteristics

($V_{DD1} = 3.3\text{ V} \pm 10\%$, $V_{DD2} = 3.3\text{ V} \pm 10\%$, $T_A = -40\text{ to }125\text{ }^\circ\text{C}$)

Parameter	Symbol	Test Condition	Min	Typ	Max	Unit
VDD Undervoltage Threshold	VDDUV+	V_{DD1}, V_{DD2} rising	2.15	2.3	2.5	V
VDD Negative-Going Lockout Hysteresis	VDDHYS		45	75	95	mV
Positive-Going Input Threshold	VT+	All inputs rising	1.6	—	1.9	V
Negative-Going Input Threshold	VT-	All inputs falling	1.1	—	1.4	V
Input Hysteresis	VHYS		0.40	0.45	0.50	V
High Level Input Voltage	VIH		2.0	—	—	V
Low Level Input Voltage	VIL		—	—	0.8	V
High Level Output Voltage	VOH	loh = -4 mA	$V_{DD1}, V_{DD2} - 0.4$	3.1	—	V
Low Level Output Voltage	VOL	lol = 4 mA	—	0.2	0.4	V
Input Leakage Current	IL		—	—	±10	µA
Output Impedance (Si8410/20) ¹	ZO		—	50	—	Ω
DC Supply Current (All inputs 0 V or at supply)						
Si8410Ax, Bx						
V_{DD1}		All inputs 0 DC	—	1.0	1.5	mA
V_{DD2}		All inputs 0 DC	—	1.0	1.5	
V_{DD1}		All inputs 1 DC	—	3.0	4.5	
V_{DD2}		All inputs 1 DC	—	1.0	1.5	
Si8420Ax, Bx						
V_{DD1}		All inputs 0 DC	—	1.3	2.0	mA
V_{DD2}		All inputs 0 DC	—	1.7	2.6	
V_{DD1}		All inputs 1 DC	—	5.8	8.7	
V_{DD2}		All inputs 1 DC	—	1.7	2.6	
Si8421Ax, Bx						
V_{DD1}		All inputs 0 DC	—	1.7	2.6	mA
V_{DD2}		All inputs 0 DC	—	1.7	2.6	
V_{DD1}		All inputs 1 DC	—	3.7	5.6	
V_{DD2}		All inputs 1 DC	—	3.7	5.6	
Si8422Ax, Bx						
V_{DD1}		All inputs 0 DC	—	3.7	5.6	mA
V_{DD2}		All inputs 0 DC	—	3.7	5.6	
V_{DD1}		All inputs 1 DC	—	1.7	2.6	
V_{DD2}		All inputs 1 DC	—	1.7	2.6	
Si8423Ax, Bx						
V_{DD1}		All inputs 0 DC	—	5.4	8.1	mA
V_{DD2}		All inputs 0 DC	—	1.7	2.6	
V_{DD1}		All inputs 1 DC	—	1.3	2.0	
V_{DD2}		All inputs 1 DC	—	1.7	2.6	
Notes:						
<ol style="list-style-type: none"> The nominal output impedance of an isolator driver channel is approximately 50 Ω, ±40%, which is a combination of the value of the on-chip series termination resistor and channel resistance of the output driver FET. When driving loads where transmission line effects will be a factor, output pins should be appropriately terminated with controlled impedance PCB traces. $t_{PSK(P-P)}$ is the magnitude of the difference in propagation delay times measured between different units operating at the same supply voltages, load, and ambient temperature. Start-up time is the time period from the application of power to valid data at the output. 						

Table 2. Electrical Characteristics (Continued)

($V_{DD1} = 3.3\text{ V} \pm 10\%$, $V_{DD2} = 3.3\text{ V} \pm 10\%$, $T_A = -40\text{ to }125\text{ }^\circ\text{C}$)

Parameter	Symbol	Test Condition	Min	Typ	Max	Unit
1 Mbps Supply Current (All inputs = 500 kHz square wave, $C_L = 15\text{ pF}$ on all outputs)						
Si8410Ax, Bx						
V_{DD1}			—	2.0	3.0	mA
V_{DD2}			—	1.1	1.7	
Si8420Ax, Bx						
V_{DD1}			—	3.5	5.3	mA
V_{DD2}			—	1.9	2.9	
Si8421Ax, Bx						
V_{DD1}			—	2.8	4.2	mA
V_{DD2}			—	2.8	4.2	
Si8422Ax, Bx						
V_{DD1}			—	2.8	4.2	mA
V_{DD2}			—	2.8	4.2	
Si8423Ax, Bx						
V_{DD1}			—	3.4	5.1	mA
V_{DD2}			—	1.9	2.9	
10 Mbps Supply Current (All inputs = 5 MHz square wave, $C_L = 15\text{ pF}$ on all outputs)						
Si8410Bx						
V_{DD1}			—	2.0	3.0	mA
V_{DD2}			—	1.3	1.8	
Si8420Bx						
V_{DD1}			—	3.5	5.3	mA
V_{DD2}			—	2.3	3.2	
Si8421Bx						
V_{DD1}			—	3.0	4.4	mA
V_{DD2}			—	3.0	4.4	
Si8422Bx						
V_{DD1}			—	3.0	4.4	mA
V_{DD2}			—	3.0	4.4	
Si8423Bx						
V_{DD1}			—	3.4	5.1	mA
V_{DD2}			—	2.2	3.1	
Notes:						
<ol style="list-style-type: none"> The nominal output impedance of an isolator driver channel is approximately $50\ \Omega$, $\pm 40\%$, which is a combination of the value of the on-chip series termination resistor and channel resistance of the output driver FET. When driving loads where transmission line effects will be a factor, output pins should be appropriately terminated with controlled impedance PCB traces. $t_{PSK(P-P)}$ is the magnitude of the difference in propagation delay times measured between different units operating at the same supply voltages, load, and ambient temperature. Start-up time is the time period from the application of power to valid data at the output. 						

Si8410/20/21 (5 kV)

Si8422/23 (2.5 & 5 kV)

Table 2. Electrical Characteristics (Continued)

($V_{DD1} = 3.3\text{ V} \pm 10\%$, $V_{DD2} = 3.3\text{ V} \pm 10\%$, $T_A = -40\text{ to }125\text{ }^\circ\text{C}$)

Parameter	Symbol	Test Condition	Min	Typ	Max	Unit
100 Mbps Supply Current (All inputs = 50 MHz square wave, $C_L = 15\text{ pF}$ on all outputs)						
Si8410Bx						
V_{DD1}			—	2.0	3.0	mA
V_{DD2}			—	3.6	4.5	
Si8420Bx						
V_{DD1}			—	4.5	5.3	mA
V_{DD2}			—	7.0	8.8	
Si8421Bx						
V_{DD1}			—	5.3	6.6	mA
V_{DD2}			—	5.3	6.6	
Si8422Bx						
V_{DD1}			—	5.3	6.6	mA
V_{DD2}			—	5.3	6.6	
Si8423Bx						
V_{DD1}			—	3.4	5.1	mA
V_{DD2}			—	6.6	8.3	
Timing Characteristics						
Si841xAx, Si842xAx						
Maximum Data Rate			0	—	1.0	Mbps
Minimum Pulse Width			—	—	250	ns
Propagation Delay	t_{PHL}, t_{PLH}	See Figure 1	—	—	35	ns
Pulse Width Distortion $ t_{PLH} - t_{PHL} $	PWD	See Figure 1	—	—	25	ns
Propagation Delay Skew ²	$t_{PSK(P-P)}$		—	—	40	ns
Channel-Channel Skew	t_{PSK}		—	—	35	ns
Si841xBx, Si842xBx						
Maximum Data Rate			0	—	150	Mbps
Minimum Pulse Width			—	—	6.0	ns
Propagation Delay	t_{PHL}, t_{PLH}	See Figure 1	4.0	8.0	11	ns
Pulse Width Distortion $ t_{PLH} - t_{PHL} $	PWD	See Figure 1	—	1.5	3.0	ns
Propagation Delay Skew ²	$t_{PSK(P-P)}$		—	2.0	3.0	ns
Channel-Channel Skew	t_{PSK}		—	0.5	1.5	ns
Notes:						
<ol style="list-style-type: none"> 1. The nominal output impedance of an isolator driver channel is approximately $50\ \Omega$, $\pm 40\%$, which is a combination of the value of the on-chip series termination resistor and channel resistance of the output driver FET. When driving loads where transmission line effects will be a factor, output pins should be appropriately terminated with controlled impedance PCB traces. 2. $t_{PSK(P-P)}$ is the magnitude of the difference in propagation delay times measured between different units operating at the same supply voltages, load, and ambient temperature. 3. Start-up time is the time period from the application of power to valid data at the output. 						

Table 2. Electrical Characteristics (Continued)

($V_{DD1} = 3.3\text{ V} \pm 10\%$, $V_{DD2} = 3.3\text{ V} \pm 10\%$, $T_A = -40\text{ to }125\text{ }^\circ\text{C}$)

Parameter	Symbol	Test Condition	Min	Typ	Max	Unit
All Models						
Output Rise Time	t_r	$C_L = 15\text{ pF}$	—	2.0	4.0	ns
Output Fall Time	t_f	$C_L = 15\text{ pF}$	—	2.0	4.0	ns
Peak Eye Diagram Jitter	$t_{JIT(PK)}$	See Figure 6	—	350	—	ps
Common Mode Transient Immunity	CMTI	$V_I = V_{DD}$ or 0 V	20	45	—	kV/ μs
Start-up Time ³	t_{SU}		—	15	40	μs

Notes:

1. The nominal output impedance of an isolator driver channel is approximately $50\ \Omega$, $\pm 40\%$, which is a combination of the value of the on-chip series termination resistor and channel resistance of the output driver FET. When driving loads where transmission line effects will be a factor, output pins should be appropriately terminated with controlled impedance PCB traces.
2. $t_{PSK(P-P)}$ is the magnitude of the difference in propagation delay times measured between different units operating at the same supply voltages, load, and ambient temperature.
3. Start-up time is the time period from the application of power to valid data at the output.

Si8410/20/21 (5 kV)

Si8422/23 (2.5 & 5 kV)

Table 3. Electrical Characteristics¹

($V_{DD1} = 2.70$ V, $V_{DD2} = 2.70$ V, $T_A = -40$ to 125 °C)

Parameter	Symbol	Test Condition	Min	Typ	Max	Unit
VDD Undervoltage Threshold	VDDUV+	V_{DD1}, V_{DD2} rising	2.15	2.3	2.5	V
VDD Negative-Going Lockout Hysteresis	VDDHYS		45	75	95	mV
Positive-Going Input Threshold	VT+	All inputs rising	1.6	—	1.9	V
Negative-Going Input Threshold	VT-	All inputs falling	1.1	—	1.4	V
Input Hysteresis	V _{HYS}		0.40	0.45	0.50	V
High Level Input Voltage	V _{IH}		2.0	—	—	V
Low Level Input Voltage	V _{IL}		—	—	0.8	V
High Level Output Voltage	V _{OH}	loh = -4 mA	$V_{DD1}, V_{DD2} - 0.4$	2.3	—	V
Low Level Output Voltage	V _{OL}	lol = 4 mA	—	0.2	0.4	V
Input Leakage Current	I _L		—	—	±10	µA
Output Impedance ²	Z _O		—	50	—	Ω
DC Supply Current (All inputs 0 V or at supply)						
Si8410Ax, Bx						
V_{DD1}		All inputs 0 DC	—	1.0	1.5	mA
V_{DD2}		All inputs 0 DC	—	1.0	1.5	
V_{DD1}		All inputs 1 DC	—	3.0	4.5	
V_{DD2}		All inputs 1 DC	—	1.0	1.5	
Si8420Ax, Bx						
V_{DD1}		All inputs 0 DC	—	1.3	2.0	mA
V_{DD2}		All inputs 0 DC	—	1.7	2.6	
V_{DD1}		All inputs 1 DC	—	5.8	8.7	
V_{DD2}		All inputs 1 DC	—	1.7	2.6	
Si8421Ax, Bx						
V_{DD1}		All inputs 0 DC	—	1.7	2.6	mA
V_{DD2}		All inputs 0 DC	—	1.7	2.6	
V_{DD1}		All inputs 1 DC	—	3.7	5.6	
V_{DD2}		All inputs 1 DC	—	3.7	5.6	
Si8422Ax, Bx						
V_{DD1}		All inputs 0 DC	—	3.7	5.6	mA
V_{DD2}		All inputs 0 DC	—	3.7	5.6	
V_{DD1}		All inputs 1 DC	—	1.7	2.6	
V_{DD2}		All inputs 1 DC	—	1.7	2.6	
Notes:						
1. Specifications in this table are also valid at $V_{DD1} = 2.6$ V and $V_{DD2} = 2.6$ V when the operating temperature range is constrained to $T_A = 0$ to 85 °C.						
2. The nominal output impedance of an isolator driver channel is approximately 50 Ω, ±40%, which is a combination of the value of the on-chip series termination resistor and channel resistance of the output driver FET. When driving loads where transmission line effects will be a factor, output pins should be appropriately terminated with controlled impedance PCB traces.						
3. $t_{PSK(P-P)}$ is the magnitude of the difference in propagation delay times measured between different units operating at the same supply voltages, load, and ambient temperature.						
4. Start-up time is the time period from the application of power to valid data at the output.						

Si8410/20/21 (5 kV) Si8422/23 (2.5 & 5 kV)

Table 3. Electrical Characteristics¹ (Continued)

(V_{DD1} = 2.70 V, V_{DD2} = 2.70 V, T_A = -40 to 125 °C)

Parameter	Symbol	Test Condition	Min	Typ	Max	Unit
Si8423Ax, Bx						
V _{DD1}		All inputs 0 DC	—	5.4	8.1	mA
V _{DD2}		All inputs 0 DC	—	1.7	2.6	
V _{DD1}		All inputs 1 DC	—	1.3	2.0	
V _{DD2}		All inputs 1 DC	—	1.7	2.6	
1 Mbps Supply Current (All inputs = 500 kHz square wave, C _L = 15 pF on all outputs)						
Si8410Ax, Bx						
V _{DD1}			—	2.0	3.0	mA
V _{DD2}			—	1.1	1.7	
Si8420Ax, Bx						
V _{DD1}			—	3.5	5.3	mA
V _{DD2}			—	1.9	2.9	
Si8421Ax, Bx						
V _{DD1}			—	2.8	4.2	mA
V _{DD2}			—	2.8	4.2	
Si8422Ax, Bx						
V _{DD1}			—	2.8	4.2	mA
V _{DD2}			—	2.8	4.2	
Si8423Ax, Bx						
V _{DD1}			—	3.3	5.0	mA
V _{DD2}			—	1.8	2.8	
10 Mbps Supply Current (All inputs = 5 MHz square wave, C _L = 15 pF on all outputs)						
Si8410Bx						
V _{DD1}			—	2.0	3.0	mA
V _{DD2}			—	1.1	1.7	
Si8420Bx						
V _{DD1}			—	3.5	5.3	mA
V _{DD2}			—	2.1	3.0	
Si8421Bx						
V _{DD1}			—	2.9	4.3	mA
V _{DD2}			—	2.9	4.3	
Notes:						
<ol style="list-style-type: none"> Specifications in this table are also valid at V_{DD1} = 2.6 V and V_{DD2} = 2.6 V when the operating temperature range is constrained to T_A = 0 to 85 °C. The nominal output impedance of an isolator driver channel is approximately 50 Ω, ±40%, which is a combination of the value of the on-chip series termination resistor and channel resistance of the output driver FET. When driving loads where transmission line effects will be a factor, output pins should be appropriately terminated with controlled impedance PCB traces. t_{PSK(P-P)} is the magnitude of the difference in propagation delay times measured between different units operating at the same supply voltages, load, and ambient temperature. Start-up time is the time period from the application of power to valid data at the output. 						

Si8410/20/21 (5 kV)

Si8422/23 (2.5 & 5 kV)

Table 3. Electrical Characteristics¹ (Continued)

(V_{DD1} = 2.70 V, V_{DD2} = 2.70 V, T_A = -40 to 125 °C)

Parameter	Symbol	Test Condition	Min	Typ	Max	Unit
Si8422Bx						
V _{DD1}			—	2.9	4.3	mA
V _{DD2}			—	2.9	4.3	
Si8423Bx						
V _{DD1}			—	3.4	5.1	mA
V _{DD2}			—	2.0	2.9	
100 Mbps Supply Current (All inputs = 50 MHz square wave, CL = 15 pF on all outputs)						
Si8410Bx						
V _{DD1}			—	2.0	3.0	mA
V _{DD2}			—	2.0	3.0	
Si8420Bx						
V _{DD1}			—	3.5	5.3	mA
V _{DD2}			—	5.5	6.9	
Si8421Bx						
V _{DD1}			—	4.6	5.8	mA
V _{DD2}			—	4.6	5.8	
Si8422Bx						
V _{DD1}			—	4.6	5.8	mA
V _{DD2}			—	4.6	5.8	
Si8423Bx						
V _{DD1}			—	3.4	5.1	mA
V _{DD2}			—	5.2	6.5	
Timing Characteristics						
Si841xAx, Si842xAx						
Maximum Data Rate			0	—	1.0	Mbps
Minimum Pulse Width			—	—	250	ns
Propagation Delay	t _{PHL} , t _{PLH}	See Figure 1	—	—	35	ns
Pulse Width Distortion t _{PLH} - t _{PHL}	PWD	See Figure 1	—	—	25	ns
Propagation Delay Skew ³	t _{PSK(P-P)}		—	—	40	ns
Channel-Channel Skew	t _{PSK}		—	—	35	ns
Si841xBx, Si842xBx						
Maximum Data Rate			0	—	150	Mbps
Notes:						
1. Specifications in this table are also valid at V _{DD1} = 2.6 V and V _{DD2} = 2.6 V when the operating temperature range is constrained to T _A = 0 to 85 °C.						
2. The nominal output impedance of an isolator driver channel is approximately 50 Ω, ±40%, which is a combination of the value of the on-chip series termination resistor and channel resistance of the output driver FET. When driving loads where transmission line effects will be a factor, output pins should be appropriately terminated with controlled impedance PCB traces.						
3. t _{PSK(P-P)} is the magnitude of the difference in propagation delay times measured between different units operating at the same supply voltages, load, and ambient temperature.						
4. Start-up time is the time period from the application of power to valid data at the output.						

Table 3. Electrical Characteristics¹ (Continued)

(V_{DD1} = 2.70 V, V_{DD2} = 2.70 V, T_A = -40 to 125 °C)

Parameter	Symbol	Test Condition	Min	Typ	Max	Unit
Minimum Pulse Width			—	—	6.0	ns
Propagation Delay	t _{PHL} , t _{PLH}	See Figure 1	4.0	8.0	11	ns
Pulse Width Distortion t _{PLH} - t _{PHL}	PWD	See Figure 1	—	1.5	3.0	ns
Propagation Delay Skew ³	t _{PSK(P-P)}		—	2.0	3.0	ns
Channel-Channel Skew	t _{PSK}		—	0.5	1.5	ns
All Models						
Output Rise Time	t _r	C _L = 15 pF	—	2.0	4.0	ns
Output Fall Time	t _f	C _L = 15 pF	—	2.0	4.0	ns
Peak Eye Diagram Jitter	t _{JIT(PK)}	See Figure 6	—	350	—	ps
Common Mode Transient Immunity	CMTI	V _I = V _{DD} or 0 V	20	45	—	kV/μs
Start-up Time ⁴	t _{SU}		—	15	40	μs
Notes:						
1. Specifications in this table are also valid at VDD1 = 2.6 V and VDD2 = 2.6 V when the operating temperature range is constrained to T _A = 0 to 85 °C.						
2. The nominal output impedance of an isolator driver channel is approximately 50 Ω, ±40%, which is a combination of the value of the on-chip series termination resistor and channel resistance of the output driver FET. When driving loads where transmission line effects will be a factor, output pins should be appropriately terminated with controlled impedance PCB traces.						
3. t _{PSK(P-P)} is the magnitude of the difference in propagation delay times measured between different units operating at the same supply voltages, load, and ambient temperature.						
4. Start-up time is the time period from the application of power to valid data at the output.						

Table 4. Absolute Maximum Ratings¹

Parameter	Symbol	Min	Typ	Max	Unit
Storage Temperature ²	T _{STG}	-65	—	150	C°
Operating Temperature	T _A	-40	—	125	C°
Supply Voltage	V _{DD1} , V _{DD2}	-0.5	—	6.0	V
Input Voltage	V _I	-0.5	—	V _{DD} + 0.5	V
Output Voltage	V _O	-0.5	—	V _{DD} + 0.5	V
Output Current Drive Channel	I _O	—	—	10	mA
Lead Solder Temperature (10 s)		—	—	260	C°
Maximum Isolation Voltage (1 s) NB SOIC-8		—	—	4500	V _{RMS}
Maximum Isolation Voltage (1 s) WB SOIC-16		—	—	6500	V _{RMS}
Notes:					
1. Permanent device damage may occur if the above absolute maximum ratings are exceeded. Functional operation should be restricted to conditions as specified in the operational sections of this data sheet.					
2. VDE certifies storage temperature from -40 to 150 °C.					

Si8410/20/21 (5 kV) Si8422/23 (2.5 & 5 kV)

Table 5. Recommended Operating Conditions

Parameter	Symbol	Test Condition	Min	Typ	Max	Unit
Ambient Operating Temperature*	T_A	150 Mbps, 15 pF, 5 V	-40	25	125	C°
Supply Voltage	V_{DD1}		2.70	—	5.5	V
	V_{DD2}		2.70	—	5.5	V

***Note:** The maximum ambient temperature is dependent upon data frequency, output loading, the number of operating channels, and supply voltage.

Table 6. Regulatory Information*

CSA
The Si84xx is certified under CSA Component Acceptance Notice 5A. For more details, see File 232873.
61010-1: Up to 600 V_{RMS} reinforced insulation working voltage; up to 600 V_{RMS} basic insulation working voltage.
60950-1: Up to 600 V_{RMS} reinforced insulation working voltage; up to 1000 V_{RMS} basic insulation working voltage.
60601-1: Up to 125 V_{RMS} reinforced insulation working voltage; up to 380 V_{RMS} basic insulation working voltage.
VDE
The Si84xx is certified according to IEC 60747-5-2. For more details, see File 5006301-4880-0001.
60747-5-2: Up to 891 V_{peak} for basic insulation working voltage.
60950-1: Up to 600 V_{RMS} reinforced insulation working voltage; up to 1000 V_{RMS} basic insulation working voltage.
UL
The Si84xx is certified under UL1577 component recognition program. For more details, see File E257455.
Rated up to 5000 V_{RMS} isolation voltage for basic insulation.
*Note: Regulatory Certifications apply to 2.5 kV_{RMS} rated devices which are production tested to 3.0 kV_{RMS} for 1 sec. Regulatory Certifications apply to 5.0 kV_{RMS} rated devices which are production tested to 6.0 kV_{RMS} for 1 sec. For more information, see "6. Ordering Guide" on page 29.

Table 7. Insulation and Safety-Related Specifications

Parameter	Symbol	Test Condition	Value		Unit
			WB SOIC-16	NB SOIC-8	
Nominal Air Gap (Clearance) ¹	L(IO1)		8.0 min	4.9 min	mm
Nominal External Tracking (Creepage) ¹	L(IO2)		8.0 min	4.01 min	mm
Minimum Internal Gap (Internal Clearance)			0.014	0.008	mm
Tracking Resistance (Proof Tracking Index)	PTI	IEC60112	600	600	V _{RMS}
Erosion Depth	ED		0.019	0.040	mm
Resistance (Input-Output) ²	R _{IO}		10 ^{1,2}	10 ^{1,2}	Ω
Capacitance (Input-Output) ²	C _{IO}	f = 1 MHz	2.0	1.0	pF
Input Capacitance ³	C _I		4.0	4.0	pF

Notes:

- The values in this table correspond to the nominal creepage and clearance values as detailed in “7. Package Outline: 16-Pin Wide Body SOIC”, “9. Package Outline: 8-Pin Narrow Body SOIC”. VDE certifies the clearance and creepage limits as 8.5 mm minimum for the WB SOIC-16 package and 4.7 mm minimum for the NB SOIC-8 package. UL does not impose a clearance and creepage minimum for component level certifications. CSA certifies the clearance and creepage limits as 3.9 mm minimum for the NB SOIC-8 and 7.6 mm minimum for the WB SOIC-16 package.
- To determine resistance and capacitance, the Si84xx is converted into a 2-terminal device. Pins 1–8 (1–4, NB SOIC-8) are shorted together to form the first terminal and pins 9–16 (5–8, NB SOIC-8) are shorted together to form the second terminal. The parameters are then measured between these two terminals.
- Measured from input pin to ground.

Table 8. IEC 60664-1 (VDE 0844 Part 2) Ratings

Parameter	Test Conditions	Specification	
		NB SOIC8	WB SOIC 16
Basic Isolation Group	Material Group	I	I
Installation Classification	Rated Mains Voltages ≤ 150 V _{RMS}	I-IV	I-IV
	Rated Mains Voltages ≤ 300 V _{RMS}	I-III	I-IV
	Rated Mains Voltages ≤ 400 V _{RMS}	I-II	I-III
	Rated Mains Voltages ≤ 600 V _{RMS}	I-II	I-III

Si8410/20/21 (5 kV)

Si8422/23 (2.5 & 5 kV)

Table 9. IEC 60747-5-2 Insulation Characteristics for Si84xxxx*

Parameter	Symbol	Test Condition	Characteristic		Unit
			WB SOIC-16	NB SOIC-8	
Maximum Working Insulation Voltage	V_{IORM}		891	560	Vpeak
Input to Output Test Voltage		Method b1 ($V_{IORM} \times 1.875 = V_{PR}$, 100% Production Test, $t_m = 1$ sec, Partial Discharge < 5 pC)	1671	1050	
Transient Overvoltage	V_{IOTM}	$t = 60$ sec	6000	4000	Vpeak
Pollution Degree (DIN VDE 0110, Table 1)			2	2	
Insulation Resistance at T_S , $V_{IO} = 500$ V	R_S		$>10^9$	$>10^9$	Ω

***Note:** Maintenance of the safety data is ensured by protective circuits. The Si84xx provides a climate classification of 40/125/21.

Table 10. IEC Safety Limiting Values¹

Parameter	Symbol	Test Condition	Min	Typ	Max		Unit
					WB SOIC-16	NB SOIC-8	
Case Temperature	T_S		—	—	150	150	°C
Safety Input, Output, or Supply Current	I_S	$\theta_{JA} = 140$ °C/W (NB SOIC-8), 100 °C (WB SOIC-16), $V_I = 5.5$ V, $T_J = 150$ °C, $T_A = 25$ °C	—	—	220	160	mA
Device Power Dissipation ²	P_D		—	—	150	150	mW

Notes:

- Maximum value allowed in the event of a failure; also see the thermal derating curve in Figures 2 and 3.
- The Si84xx is tested with $VDD1 = VDD2 = 5.5$ V, $T_J = 150$ °C, $C_L = 15$ pF, input a 150 Mbps 50% duty cycle square wave.

Table 11. Thermal Characteristics

Parameter	Symbol	WB SOIC-16	NB SOIC-8	Unit
IC Junction-to-Air Thermal Resistance	θ_{JA}	100	140	$^{\circ}\text{C}/\text{W}$

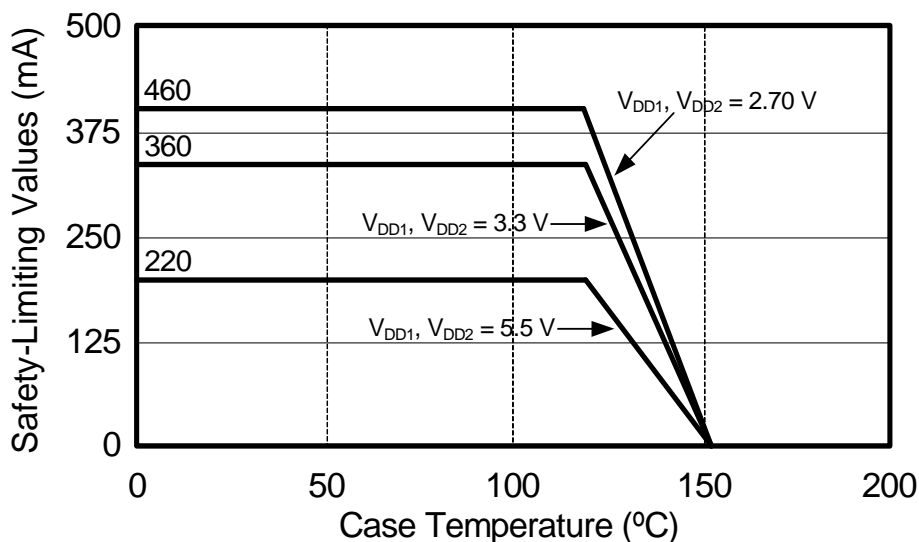

Figure 2. (WB SOIC-16) Thermal Derating Curve, Dependence of Safety Limiting Values with Case Temperature per DIN EN 60747-5-2

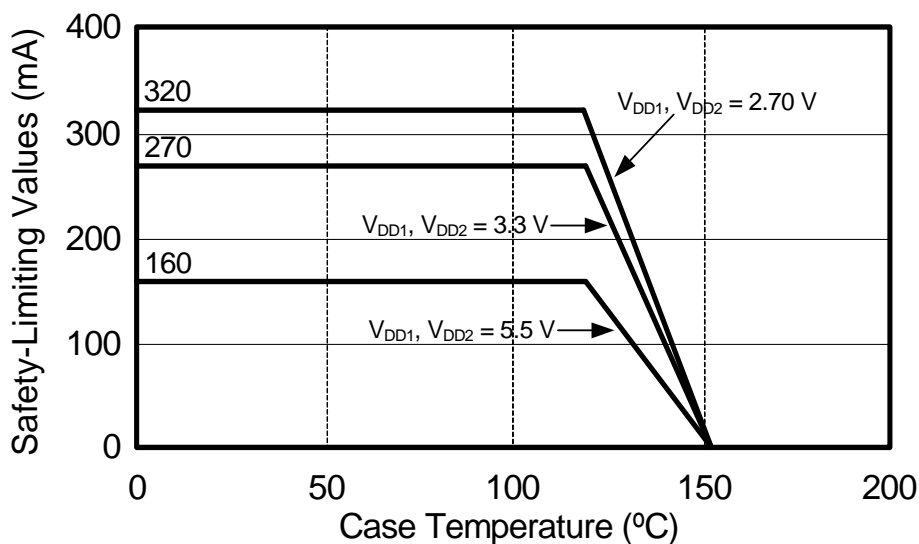

Figure 3. (NB SOIC-8) Thermal Derating Curve, Dependence of Safety Limiting Values with Case Temperature per DIN EN 60747-5-2

2. Functional Description

2.1. Theory of Operation

The operation of an Si84xx channel is analogous to that of an opto coupler, except an RF carrier is modulated instead of light. This simple architecture provides a robust isolated data path and requires no special considerations or initialization at start-up. A simplified block diagram for a single Si84xx channel is shown in Figure 4.



Figure 4. Simplified Channel Diagram

A channel consists of an RF Transmitter and RF Receiver separated by a semiconductor-based isolation barrier. Referring to the Transmitter, input A modulates the carrier provided by an RF oscillator using on/off keying. The Receiver contains a demodulator that decodes the input state according to its RF energy content and applies the result to output B via the output driver. This RF on/off keying scheme is superior to pulse code schemes as it provides best-in-class noise immunity, low power consumption, and better immunity to magnetic fields. See Figure 5 for more details.

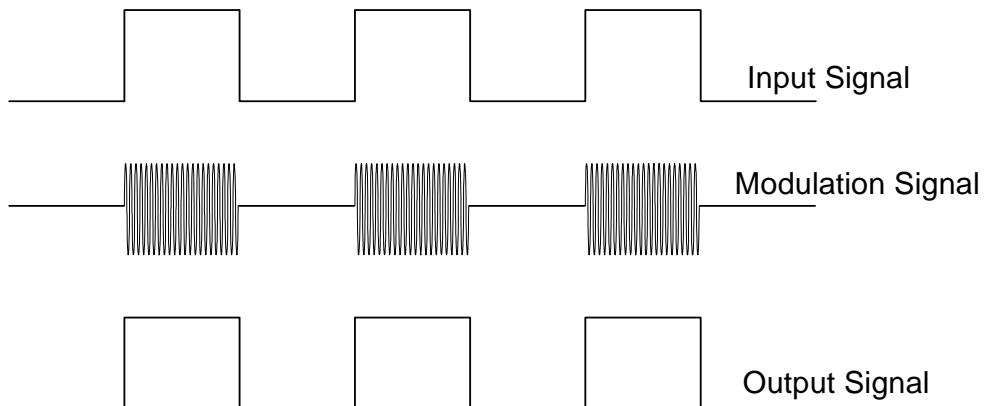

Figure 5. Modulation Scheme

2.2. Eye Diagram

Figure 6 illustrates an eye-diagram taken on an Si8422. For the data source, the test used an Anritsu (MP1763C) Pulse Pattern Generator set to 1000 ns/div. The output of the generator's clock and data from an Si8422 were captured on an oscilloscope. The results illustrate that data integrity was maintained even at the high data rate of 150 Mbps. The results also show that 2 ns pulse width distortion and 250 ps peak jitter were exhibited.

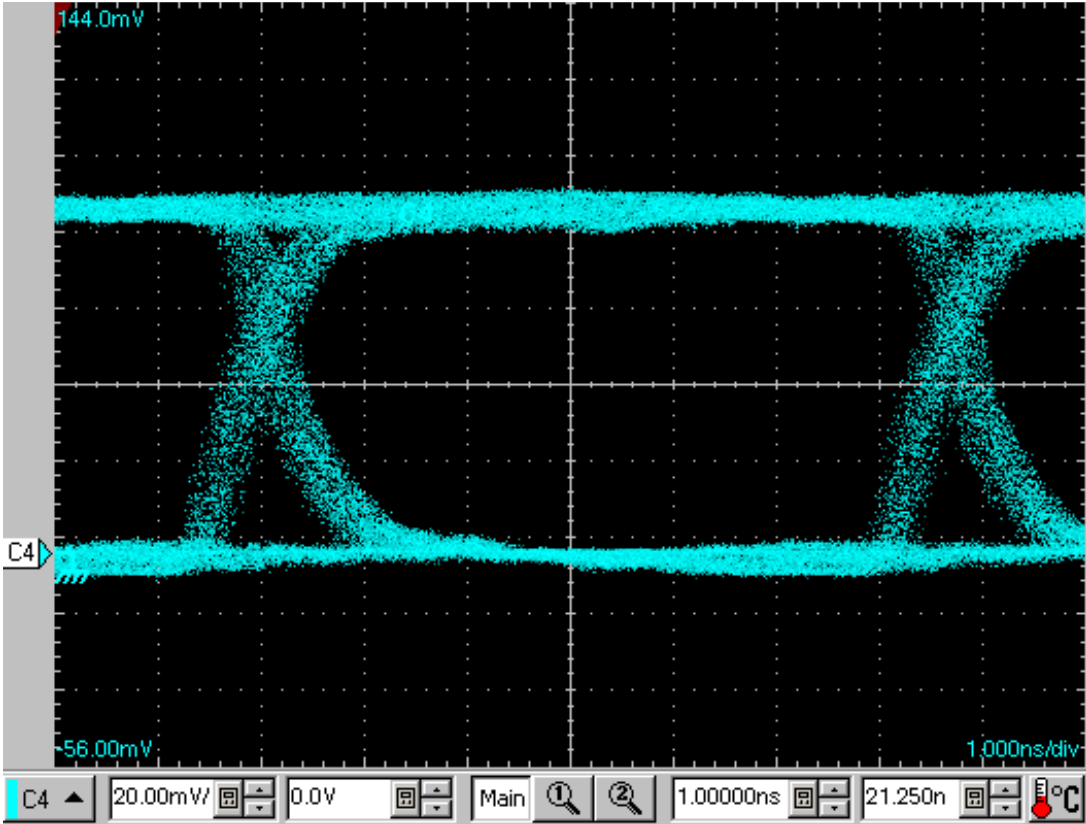

Figure 6. Eye Diagram

Si8410/20/21 (5 kV)

Si8422/23 (2.5 & 5 kV)

3. Device Operation

Device behavior during start-up, normal operation, and shutdown is shown in Figure 7, where UVLO+ and UVLO- are the positive-going and negative-going thresholds respectively. Refer to Table 12 to determine outputs when power supply (V_{DD}) is not present.

Table 12. Si84xx Logic Operation Table

V_I Input ^{1,4}	VDDI State ^{1,2,3}	VDDO State ^{1,2,3}	V_O Output ^{1,4}	Comments
H	P	P	H	Normal operation.
L	P	P	L	
X ⁵	UP	P	H ⁶ (Si8422/23) L ⁶ (Si8410/20/21)	Upon transition of VDDI from unpowered to powered, V_O returns to the same state as V_I in less than 1 μ s.
X ⁵	P	UP	Undetermined	Upon transition of VDDO from unpowered to powered, V_O returns to the same state as V_I within 1 μ s.

Notes:

1. VDDI and VDDO are the input and output power supplies. V_I and V_O are the respective input and output terminals.
2. Powered (P) state is defined as $2.70\text{ V} < V_{DD} < 5.5\text{ V}$.
3. Unpowered (UP) state is defined as $V_{DD} = 0\text{ V}$.
4. X = not applicable; H = Logic High; L = Logic Low.
5. Note that an I/O can power the die for a given side through an internal diode if its source has adequate current.
6. See "6. Ordering Guide" on page 29 for details. This is the selectable fail-safe operating mode (ordering option). Some devices have default output state = H, and some have default output state = L, depending on the ordering part number (OPN).

3.1. Device Startup

Outputs are held low during powerup until V_{DD} is above the UVLO threshold for time period t_{START} . Following this, the outputs follow the states of inputs.

3.2. Under Voltage Lockout

Under Voltage Lockout (UVLO) is provided to prevent erroneous operation during device startup and shutdown or when V_{DD} is below its specified operating circuits range. Both Side A and Side B each have their own undervoltage lockout monitors. Each side can enter or exit UVLO independently. For example, Side A unconditionally enters UVLO when V_{DD1} falls below $V_{DD1(UVLO-)}$ and exits UVLO when V_{DD1} rises above $V_{DD1(UVLO+)}$. Side B operates the same as Side A with respect to its V_{DD2} supply.

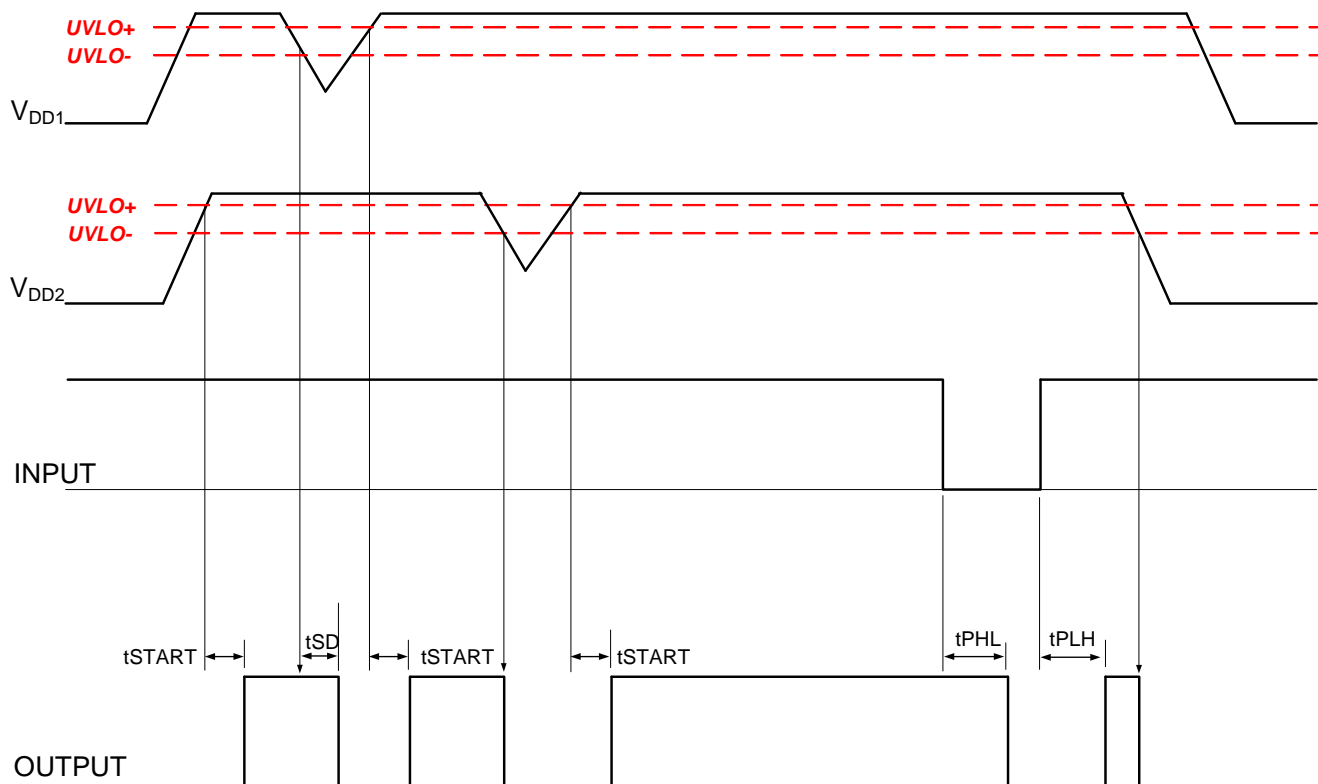

Figure 7. Device Behavior during Normal Operation

Si8410/20/21 (5 kV) Si8422/23 (2.5 & 5 kV)

3.3. Layout Recommendations

To ensure safety in the end user application, high voltage circuits (i.e., circuits with $>30 V_{AC}$) must be physically separated from the safety extra-low voltage circuits (SELV is a circuit with $<30 V_{AC}$) by a certain distance (creepage/clearance). If a component, such as a digital isolator, straddles this isolation barrier, it must meet those creepage/clearance requirements and also provide a sufficiently large high-voltage breakdown protection rating (commonly referred to as working voltage protection). Table 6 on page 16 and Table 7 on page 17 detail the working voltage and creepage/clearance capabilities of the Si84xx. These tables also detail the component standards (UL1577, IEC60747, CSA 5A), which are readily accepted by certification bodies to provide proof for end-system specifications requirements. Refer to the end-system specification (61010-1, 60950-1, 60601-1, etc.) requirements before starting any design that uses a digital isolator.

3.3.1. Supply Bypass

The Si841x/2x family requires a 0.1 μF bypass capacitor between V_{DD1} and GND1 and V_{DD2} and GND2. The capacitor should be placed as close as possible to the package. To enhance the robustness of a design, it is further recommended that the user also add 1 μF bypass capacitors and include 100 Ω resistors in series with the inputs and outputs if the system is excessively noisy.

3.3.2. Pin Connections

No connect pins are not internally connected. They can be left floating, tied to V_{DD} , or tied to GND.

3.3.3. Output Pin Termination

The nominal output impedance of an isolator driver channel is approximately 50 Ω , $\pm 40\%$, which is a combination of the value of the on-chip series termination resistor and channel resistance of the output driver FET. When driving loads where transmission line effects will be a factor, output pins should be appropriately terminated with controlled impedance PCB traces.

3.4. Fail-Safe Operating Mode

Si84xx devices feature a selectable (by ordering option) mode whereby the default output state (when the input supply is unpowered) can either be a logic high or logic low when the output supply is powered. See Table 12 on page 22 and "6. Ordering Guide" on page 29 for more information.

3.5. Typical Performance Characteristics

The typical performance characteristics depicted in the following diagrams are for information purposes only. Refer to Tables 1, 2, and 3 for actual specification limits.

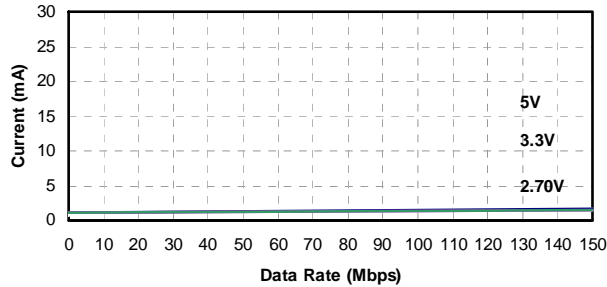

Figure 8. Si8410 Typical V_{DD1} Supply Current vs. Data Rate 5, 3.3, and 2.70 V Operation

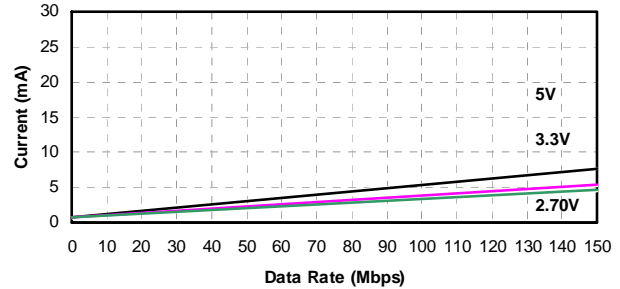

Figure 11. Si8410 Typical V_{DD2} Supply Current vs. Data Rate 5, 3.3, and 2.70 V Operation (15 pF Load)

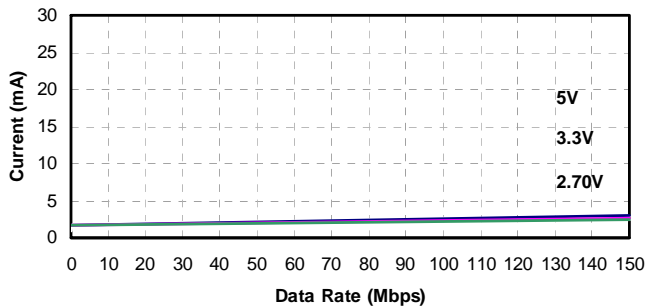

Figure 9. Si8420 Typical V_{DD1} Supply Current vs. Data Rate 5, 3.3, and 2.70 V Operation

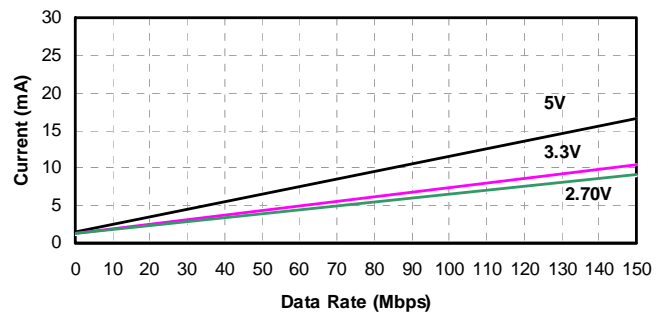

Figure 12. Si8420 Typical V_{DD2} Supply Current vs. Data Rate 5, 3.3, and 2.70 V Operation (15 pF Load)

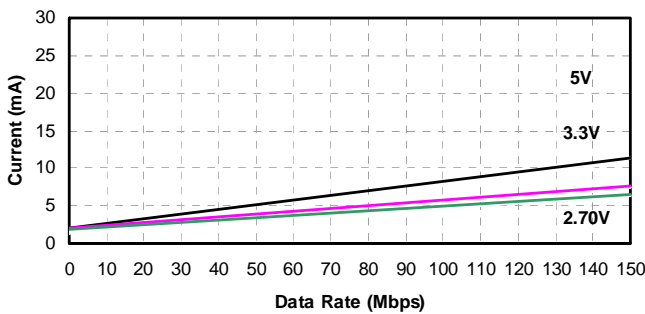

Figure 10. Si8421 Typical V_{DD1} or V_{DD2} Supply Current vs. Data Rate 5, 3.3, and 2.70 V Operation (15 pF Load)

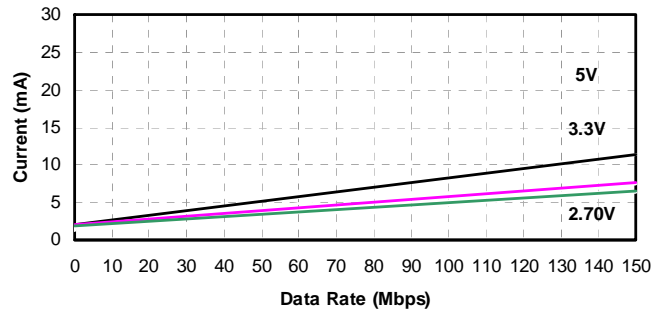

Figure 13. Si8422 Typical V_{DD1} or V_{DD2} Supply Current vs. Data Rate 5, 3.3, and 2.70 V Operation (15 pF Load)

Si8410/20/21 (5 kV) Si8422/23 (2.5 & 5 kV)

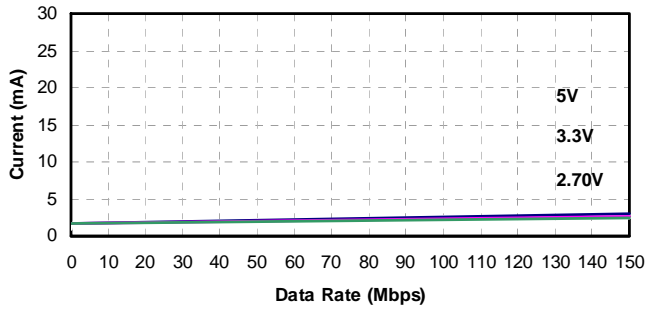

Figure 14. Si8423 Typical V_{DD1} Supply Current vs. Data Rate 5, 3.3, and 2.70 V Operation

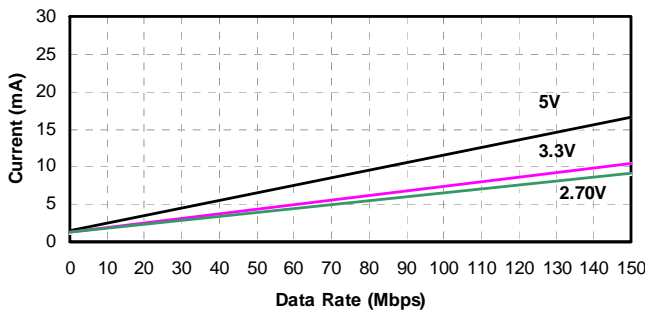

Figure 15. Si8423 Typical V_{DD2} Supply Current vs. Data Rate 5, 3.3, and 2.70 V Operation (15 pF Load)

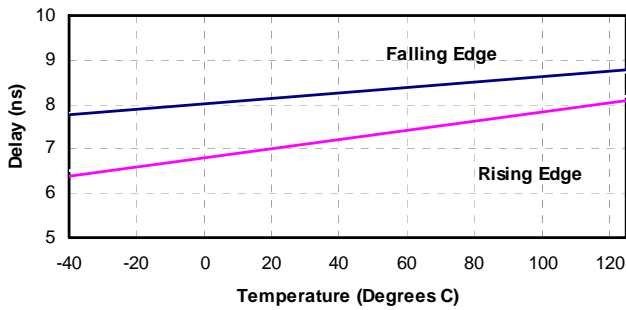
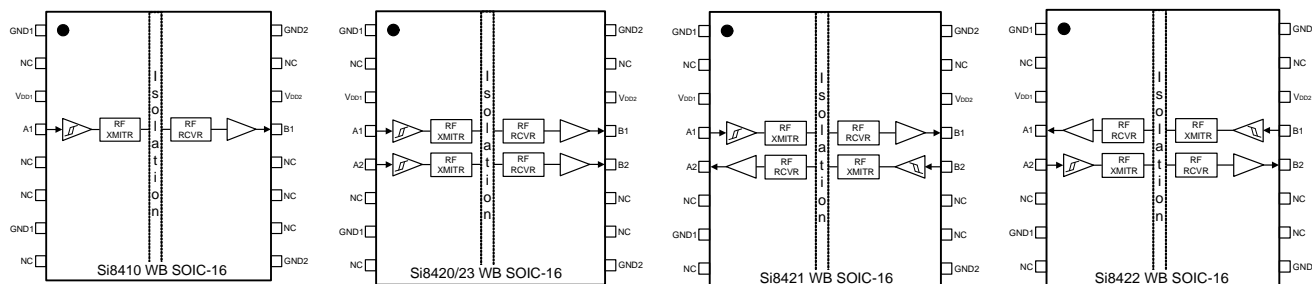

Figure 16. Propagation Delay vs. Temperature

4. Pin Descriptions (Wide-Body SOIC)



Name	SOIC-16 Pin# Si8410	SOIC-16 Pin# Si842x	Type	Description
GND1	1	1	Ground	Side 1 ground.
NC*	2, 5, 6, 8,10, 11, 12, 15	2, 6, 8,10, 11, 15	No Connect	NC
V _{DD1}	3	3	Supply	Side 1 power supply.
A1	4	4	Digital I/O	Side 1 digital input or output.
A2	NC	5	Digital I/O	Side 1 digital input or output.
GND1	7	7	Ground	Side 1 ground.
GND2	9	9	Ground	Side 2 ground.
B2	NC	12	Digital I/O	Side 2 digital input or output.
B1	13	13	Digital I/O	Side 2 digital input or output.
V _{DD2}	14	14	Supply	Side 2 power supply.
GND2	16	16	Ground	Side 2 ground.

***Note:** No Connect. These pins are not internally connected. They can be left floating, tied to V_{DD} or tied to GND.

Si8410/20/21 (5 kV) Si8422/23 (2.5 & 5 kV)

5. Pin Descriptions (Narrow-Body SOIC)

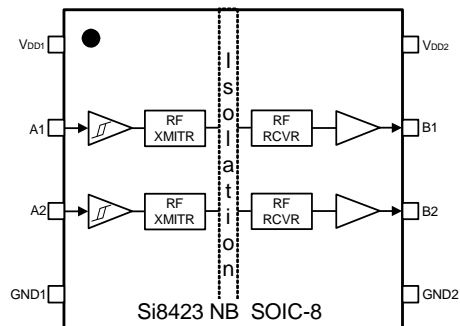
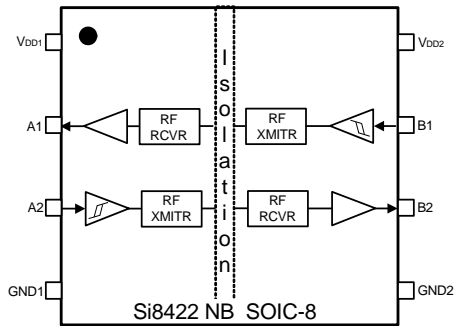

Name	SOIC-8 Pin# Si842x	Type	Description
V_{DD1}	1	Supply	Side 1 power supply.
GND1	4	Ground	Side 1 ground.
A1	2	Digital I/O	Side 1 digital input or output.
A2	3	Digital I/O	Side 1 digital input or output.
B1	7	Digital I/O	Side 2 digital input or output.
B2	6	Digital I/O	Side 2 digital input or output.
V_{DD2}	8	Supply	Side 2 power supply.
GND2	5	Ground	Side 2 ground.

6. Ordering Guide

Table 13. Ordering Guide¹

Ordering Part Number (OPN)	Number of Inputs VDD1 Side	Number of Inputs VDD2 Side	Maximum Data Rate (Mbps)	Default Output State	Isolation Rating	Temp Range	Package Type
Si8422AB-B-IS	1	1	1	High	2.5 kVrms	-40 to 125 °C	NB SOIC-8
Si8422BB-B-IS	1	1	150	High			
Si8423AB-B-IS	2	0	1	High			
Si8423BB-B-IS	2	0	150	High			
Si8410AD-A-IS ²	1	0	1	Low	5.0 kVrms	-40 to 125 °C	WB SOIC-16
Si8410BD-A-IS ²	1	0	150	Low			
Si8420AD-A-IS ²	2	0	1	Low			
Si8420BD-A-IS ²	2	0	150	Low			
Si8421AD-B-IS ²	1	1	1	Low			
Si8421BD-B-IS ²	1	1	150	Low			
Si8422AD-B-IS	1	1	1	High			
Si8422BD-B-IS	1	1	150	High			
Si8423AD-B-IS	2	0	1	High			
Si8423BD-B-IS	2	0	150	High			

Notes:

1. All packages are RoHS-compliant with peak reflow temperatures of 260 °C according to the JEDEC industry standard classifications and peak solder temperatures.
 Moisture sensitivity level is MSL2A for wide-body SOIC-16 packages.
 Moisture sensitivity level is MSL2A for narrow-body SOIC-8 packages.
2. Refer to Si8410/20/21 data sheet for information regarding 2.5 kV rated versions of these products.

Si8410/20/21 (5 kV) Si8422/23 (2.5 & 5 kV)

7. Package Outline: 16-Pin Wide Body SOIC

Figure 17 illustrates the package details for the Si84xx Digital Isolator. Table 14 lists the values for the dimensions shown in the illustration.

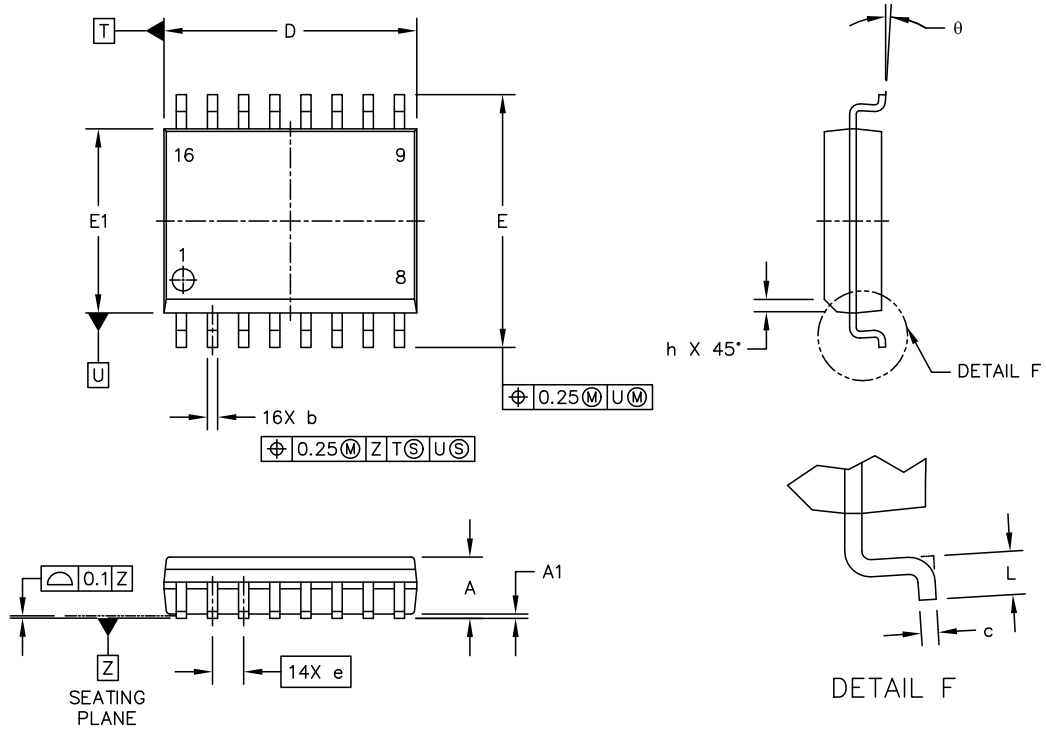

Figure 17. 16-Pin Wide Body SOIC

Table 14. Package Diagram Dimensions

Symbol	Millimeters	
	Min	Max
A	—	2.65
A1	0.1	0.3
D	10.3 BSC	
E	10.3 BSC	
E1	7.5 BSC	
b	0.31	0.51
c	0.20	0.33
e	1.27 BSC	
h	0.25	0.75
L	0.4	1.27
θ	0°	7°

8. Land Pattern: 16-Pin Wide-Body SOIC

Figure 18 illustrates the recommended land pattern details for the Si84xx in a 16-pin wide-body SOIC. Table 15 lists the values for the dimensions shown in the illustration.

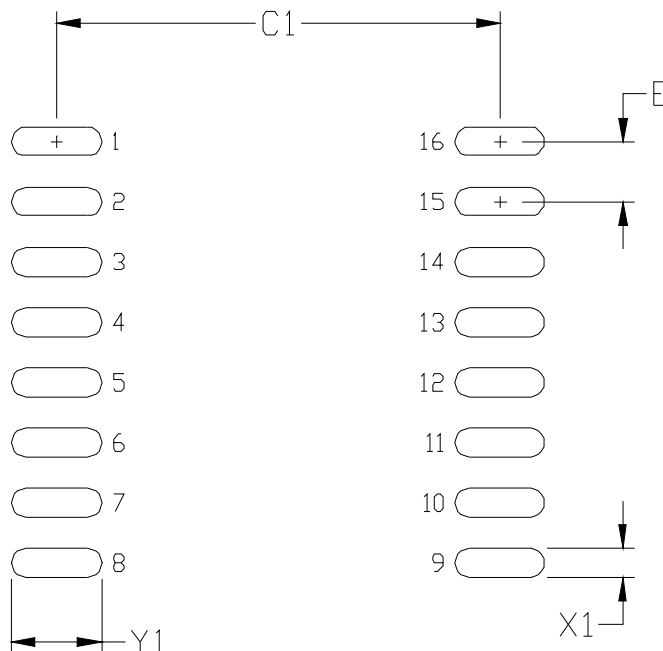

Figure 18. 16-Pin SOIC Land Pattern

Table 15. 16-Pin Wide Body SOIC Land Pattern Dimensions

Dimension	Feature	(mm)
C1	Pad Column Spacing	9.40
E	Pad Row Pitch	1.27
X1	Pad Width	0.60
Y1	Pad Length	1.90

Notes:

1. This Land Pattern Design is based on IPC-7351 pattern SOIC127P1032X265-16AN for Density Level B (Median Land Protrusion).
2. All feature sizes shown are at Maximum Material Condition (MMC) and a card fabrication tolerance of 0.05 mm is assumed.

Si8410/20/21 (5 kV) Si8422/23 (2.5 & 5 kV)

9. Package Outline: 8-Pin Narrow Body SOIC

Figure 19 illustrates the package details for the Si84xx. Table 16 lists the values for the dimensions shown in the illustration.

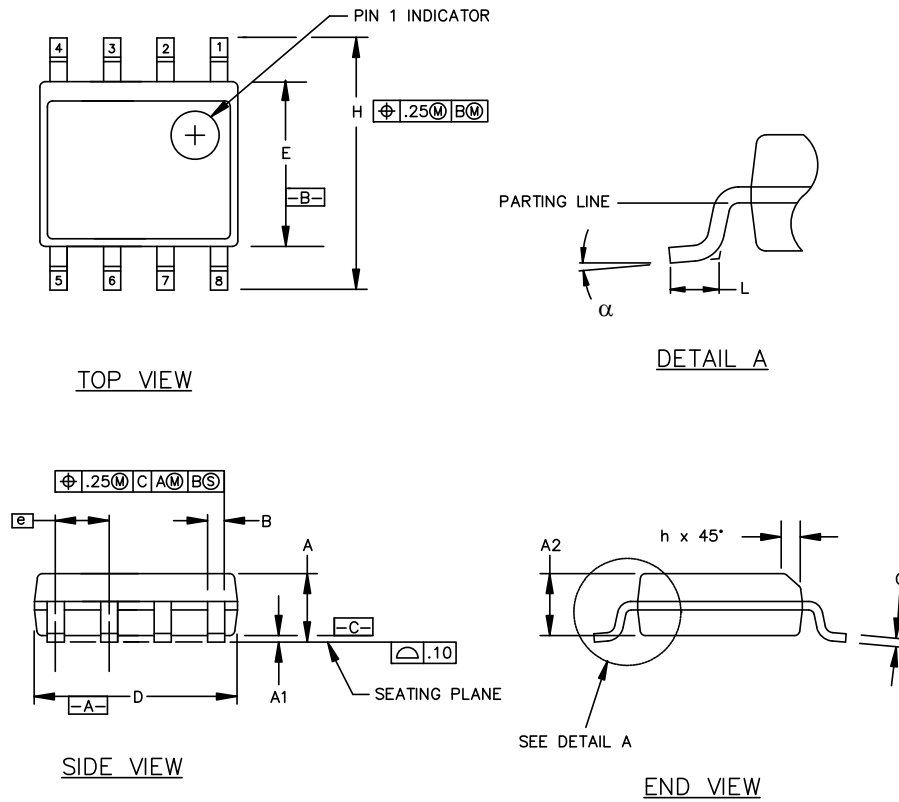

Figure 19. 8-pin Small Outline Integrated Circuit (SOIC) Package

Table 16. Package Diagram Dimensions

Symbol	Millimeters	
	Min	Max
A	1.35	1.75
A1	0.10	0.25
A2	1.40 REF	1.55 REF
B	0.33	0.51
C	0.19	0.25
D	4.80	5.00
E	3.80	4.00
e	1.27 BSC	
H	5.80	6.20
h	0.25	0.50
L	0.40	1.27
α	0°	8°

10. Land Pattern: 8-Pin Narrow Body SOIC

Figure 20 illustrates the recommended land pattern details for the Si84xx in an 8-pin narrow-body SOIC. Table 17 lists the values for the dimensions shown in the illustration.

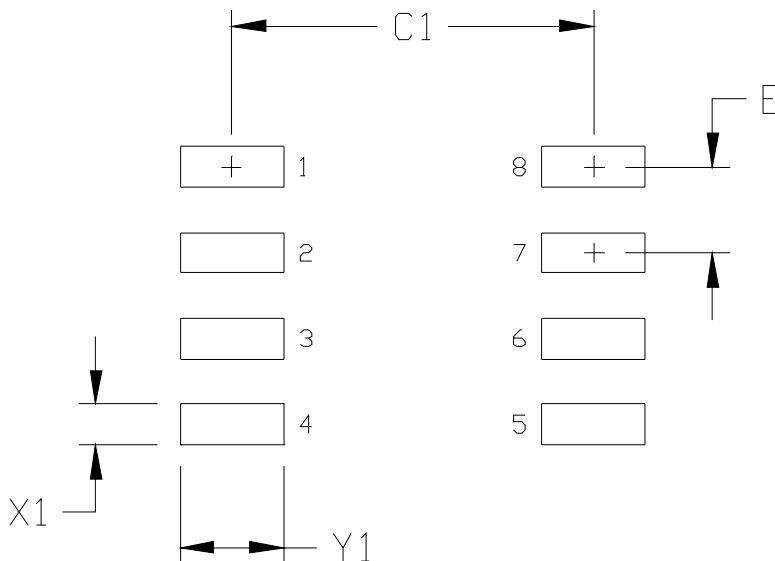

Figure 20. PCB Land Pattern: 8-Pin Narrow Body SOIC

Table 17. PCM Land Pattern Dimensions (8-Pin Narrow Body SOIC)

Dimension	Feature	(mm)
C1	Pad Column Spacing	5.40
E	Pad Row Pitch	1.27
X1	Pad Width	0.60
Y1	Pad Length	1.55
Notes:		
<ol style="list-style-type: none"> 1. This Land Pattern Design is based on IPC-7351 pattern SOIC127P600X173-8N for Density Level B (Median Land Protrusion). 2. All feature sizes shown are at Maximum Material Condition (MMC) and a card fabrication tolerance of 0.05 mm is assumed. 		

Si8410/20/21 (5 kV) Si8422/23 (2.5 & 5 kV)

11. Top Marking: 16-Pin Wide Body SOIC

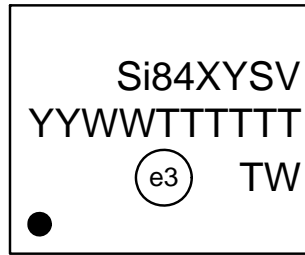

Figure 21. Isolator Top Marking

Table 18. Top Marking Explanation

Line 1 Marking:	Base Part Number Ordering Options (See Ordering Guide for more information).	Si84 = Isolator product series XY = Channel Configuration X = # of data channels (2, 1) Y = # of reverse channels (1, 0) ^{1,2} S = Speed Grade A = 1 Mbps; B = 150 Mbps V = Insulation rating A = 1 kV; B = 2.5 kV; C = 3.75 kV; D = 5 kV
Line 2 Marking:	YY = Year WW = Workweek	Assigned by assembly subcontractor. Corresponds to the year and workweek of the mold date.
	TTTTTT = Mfg Code	Manufacturing code from assembly house.
Line 3 Marking:	Circle = 1.5 mm Diameter (Center-Justified)	"e3" Pb-Free Symbol.
	Country of Origin ISO Code Abbreviation	TW = Taiwan.
Notes:		
1. The Si8422 has one reverse channel.		
2. The Si8423 has zero reverse channels.		

12. Top Marking: 8-Pin Narrow-Body SOIC

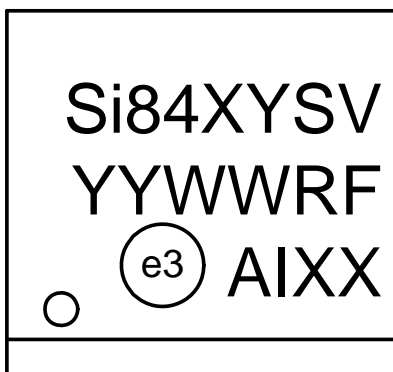

Figure 22. Isolator Top Marking

Table 19. Top Marking Explanations

Line 1 Marking:	Base Part Number Ordering Options (See Ordering Guide for more information).	Si84 = Isolator product series XY = Channel Configuration X = # of data channels (2, 1) Y = # of reverse channels (1, 0) ^{1,2} S = Speed Grade A = 1 Mbps; B = 150 Mbps V = Insulation rating A = 1 kV; B = 2.5 kV; C = 3.75 kV; D = 5 kV
Line 2 Marking:	YY = Year WW = Workweek	Assigned by assembly subcontractor. Corresponds to the year and workweek of the mold date.
	R = Product (OPN) Revision F = Wafer Fab	
Line 3 Marking:	Circle = 1.1 mm Diameter Left-Justified	"e3" Pb-Free Symbol. First two characters of the manufacturing code.
	A = Assembly Site I = Internal Code XX = Serial Lot Number	Last four characters of the manufacturing code.
Notes:		
1. The Si8422 has one reverse channel.		
2. The Si8423 has zero reverse channels.		

DOCUMENT CHANGE LIST

Revision 0.1 to Revision 1.0

- Updated “ Features” on page 1.
 - Updated transient immunity
- Removed Block Diagram from page 1.
- Added chip graphics on page 1.
- Added Peak Eye Diagram jitter in Tables 1, 2, and 3.
 - Updated transient immunity
- Moved Table 12 to page 22.
- Added "3. Device Operation" on page 22.
- Added "3.4. Fail-Safe Operating Mode" on page 24.
- Moved “Typical Performance Characteristics” to page 25.
- Deleted RF Radiated Emissions section.
- Deleted RF Magnetic and Common-Mode Transient Immunity section.
- Updated MSL rating to MSL2A.

Revision 1.0 to Revision 1.1

- Numerous text edits.
- Added notes to Tables 18 and 19.

Revision 1.1 to Revision 1.2

- Updated Timing Characteristics in Tables 1, 2, and 3.

NOTES:

Si8410/20/21 (5 kV) Si8422/23 (2.5 & 5 kV)

CONTACT INFORMATION

Silicon Laboratories Inc.

400 West Cesar Chavez
Austin, TX 78701
Tel: 1+(512) 416-8500
Fax: 1+(512) 416-9669
Toll Free: 1+(877) 444-3032



Please visit the Silicon Labs Technical Support web page:
<https://www.silabs.com/support/pages/contacttechnicalsupport.aspx>
and register to submit a technical support request.

The information in this document is believed to be accurate in all respects at the time of publication but is subject to change without notice. Silicon Laboratories assumes no responsibility for errors and omissions, and disclaims responsibility for any consequences resulting from the use of information included herein. Additionally, Silicon Laboratories assumes no responsibility for the functioning of undescribed features or parameters. Silicon Laboratories reserves the right to make changes without further notice. Silicon Laboratories makes no warranty, representation or guarantee regarding the suitability of its products for any particular purpose, nor does Silicon Laboratories assume any liability arising out of the application or use of any product or circuit, and specifically disclaims any and all liability, including without limitation consequential or incidental damages. Silicon Laboratories products are not designed, intended, or authorized for use in applications intended to support or sustain life, or for any other application in which the failure of the Silicon Laboratories product could create a situation where personal injury or death may occur. Should Buyer purchase or use Silicon Laboratories products for any such unintended or unauthorized application, Buyer shall indemnify and hold Silicon Laboratories harmless against all claims and damages.

Silicon Laboratories and Silicon Labs are trademarks of Silicon Laboratories Inc.
Other products or brandnames mentioned herein are trademarks or registered trademarks of their respective holders.

Looking for pricing, stock, or lifecycle information?

Click below to explore more details on WIN SOURCE:

-  [View S18420BD-A-ISR on WIN SOURCE](#)
-  [Skyworks Solutions Inc. Information](#)

Optimize Your Supply Chain with WIN SOURCE Solutions

-  Global Sourcing Solution
-  Obsolete Management
-  Cost Control Management
-  Shortage Management
-  Alternative Solution
-  Excess Inventory Management