



**THE DATASHEET OF
SI8275BB-IS1**



Si827x Data Sheet

4 Amp ISOdriver with High Transient (dV/dt) Immunity

The Si827x isolators are ideal for driving power switches used in a wide variety of power supply, inverter, and motor control applications. The Si827x isolated gate drivers utilize Skyworks' proprietary silicon isolation technology, supporting up to 2.5 kV_{RMS} withstand voltage per UL1577 and VDE0884. This technology enables industry leading common-mode transient immunity (CMTI), tight timing specifications, reduced variation with temperature and age, better part-to-part matching, and extremely high reliability. It also offers unique features such as separate pull-up/down outputs, driver shutdown on UVLO fault, and precise dead-time programmability. The Si827x series offers longer service life and dramatically higher reliability compared to opto-coupled gate drivers.

The Si827x drivers utilize Skyworks' proprietary silicon isolation technology, which provides up to 2.5 kV_{RMS} withstand voltage per UL1577 and fast 60 ns propagation times. Driver outputs can be grounded to the same or separate grounds or connected to a positive or negative voltage. The TTL level compatible inputs with >400 mV hysteresis are available in individual control input (Si8271/2/3/5) or PWM input (Si8274) configurations. High integration, low propagation delay, small installed size, flexibility, and cost-effectiveness make the Si827x family ideal for a wide range of isolated MOSFET/IGBT and SiC or GaN FET gate drive applications.

Automotive Grade products are built using automotive-specific flows at all steps in the manufacturing process to ensure the robustness and low defectivity required for automotive applications.

Industrial Applications

- Switch-mode Power Supplies
- Solar Power Inverters
- Motor control and drives
- Uninterruptible Power Supplies
- High-Power Class D Amplifiers

Safety Regulatory Approvals

- UL 1577 recognized
 - Up to 2500 V_{RMS} for 1 minute
- CSA approval
 - IEC 60950-1 (reinforced insulation)
- VDE certification conformity
 - VDE 0884 Part 10
- CQC certification approval
 - GB4943.1-2011

Automotive Applications

- On-board chargers
- Battery management systems
- Charging stations
- Traction inverters
- Hybrid Electric Vehicles
- Battery Electric Vehicles

KEY FEATURES

- Single, dual, or high-side/low-side drivers
- Single PWM or dual digital inputs
- High dV/dt immunity:
 - 200 kV/μs CMTI
 - 400 kV/μs Latch-up
- Separate pull-up/down outputs for slew rate control
- Wide supply range:
 - Input supply: 2.5–5.5 V
 - Driver supply: 4.2–30 V
- Very low jitter of 200 ps p-p
- 60 ns propagation delay (max)
- Dedicated enable pin
- Skyworks' high performance isolation technology:
 - Industry leading noise immunity
 - High speed, low latency and skew
 - Best reliability available
- Compact packages:
 - 8-pin SOIC
 - 16-pin SOIC
 - DFN-14 (pin to pin compatible with LGA-14 packages)
- Wide temperature range:
 - –40 to 125 °C
- AEC-Q100 Qualified
- Automotive-grade OPNs available
 - AIAG compliant PPAP documentation support
 - IMDS and CAMDS listing support

1. Ordering Guide

Industrial and Automotive Grade OPNs

Industrial-grade devices (part numbers having an “-I” in their suffix) are built using well-controlled, high-quality manufacturing flows to ensure robustness and reliability. Qualifications are compliant with JEDEC, and defect reduction methodologies are used throughout definition, design, evaluation, qualification, and mass production steps.

Automotive-grade devices (part numbers having an “-A” in their suffix) are built using automotive-specific flows at all steps in the manufacturing process to ensure robustness and low defectivity. These devices are supported with AIAG-compliant Production Part Approval Process (PPAP) documentation, and feature International Material Data System (IMDS) and China Automotive Material Data System (CAMDS) listing. Qualifications are compliant with AEC-Q100, and a zero-defect methodology is employed throughout definition, design, evaluation, qualification, and mass production steps.

Table 1.1. Si827x Ordering Guide^{1, 2, 3}

Ordering Part Number	Automotive OPN ^{4, 5}	Inputs	Driver Configuration ⁶	Output UVLO (V)	Integrated Deglitcher	Dead-Time Range (ns)	Low Jitter	Package	Isolation Rating
2.5 kV_{RMS} Isolation Options									
Si8271AB-IS	Si8271AB-AS	VI	Single	5	N	N/A	Y	SOIC-8 NB	2.5 kV _{RMS}
Si8271BB-IS	Si8271BB-AS	VI	Single	8	N	N/A	Y	SOIC-8 NB	2.5 kV _{RMS}
Si8271ABD-IS	Si8271ABD-AS	VI	Single	5	Y	N/A	N	SOIC-8 NB	2.5 kV _{RMS}
Si8271BBD-IS	Si8271BBD-AS	VI	Single	8	Y	N/A	N	SOIC-8 NB	2.5 kV _{RMS}
Si8271DB-IS	Si8271DB-AS	VI	Single	12	N	N/A	Y	SOIC-8 NB	2.5 kV _{RMS}
Si8271DBD-IS	Si8271DBD-AS	VI	Single	12	Y	N/A	N	SOIC-8 NB	2.5 kV _{RMS}
Si8271GB-IS	Si8271GB-AS	VI	Single	3	N	N/A	Y	SOIC-8 NB	2.5 kV _{RMS}
Si8271GBD-IS	Si8271GBD-AS	VI	Single	3	Y	N/A	N	SOIC-8 NB	2.5 kV _{RMS}
Si8273AB-IS1	Si8273AB-AS1	VIA/VIB	HS/LS	5	N	N/A	Y	SOIC-16 NB	2.5 kV _{RMS}
Si8273ABD-IS1	Si8273ABD-AS1	VIA/VIB	HS/LS	5	Y	N/A	N	SOIC-16 NB	2.5 kV _{RMS}
Si8273BB-IS1	Si8273BB-AS1	VIA/VIB	HS/LS	8	N	N/A	Y	SOIC-16 NB	2.5 kV _{RMS}
Si8273BBD-IS1	Si8273BBD-AS1	VIA/VIB	HS/LS	8	Y	N/A	N	SOIC-16 NB	2.5 kV _{RMS}
Si8273DB-IS1	Si8273DB-AS1	VIA/VIB	HS/LS	12	N	N/A	Y	SOIC-16 NB	2.5 kV _{RMS}
Si8273DBD-IS1	Si8273DBD-AS1	VIA/VIB	HS/LS	12	Y	N/A	N	SOIC-16 NB	2.5 kV _{RMS}
Si8273GB-IS1	Si8273GB-AS1	VIA/VIB	HS/LS	3	N	N/A	Y	SOIC-16 NB	2.5 kV _{RMS}
Si8273GBD-IS1	Si8273GBD-AS1	VIA/VIB	HS/LS	3	Y	N/A	N	SOIC-16 NB	2.5 kV _{RMS}
Si8274AB1-IS1	Si8274AB1-AS1	PWM	HS/LS	5	N	10-200	Y	SOIC-16 NB	2.5 kV _{RMS}
Si8274AB4D-IS1	Si8274AB4D-AS1	PWM	HS/LS	5	Y	20-700	N	SOIC-16 NB	2.5 kV _{RMS}
Si8274BB1-IS1	Si8274BB1-AS1	PWM	HS/LS	8	N	10-200	Y	SOIC-16 NB	2.5 kV _{RMS}
Si8274BB4D-IS1	Si8274BB4D-AS1	PWM	HS/LS	8	Y	20-700	N	SOIC-16 NB	2.5 kV _{RMS}
Si8274DB1-IS1	Si8274DB1-AS1	PWM	HS/LS	12	N	10-200	Y	SOIC-16 NB	2.5 kV _{RMS}
Si8274DB4D-IS1	Si8274DB4D-AS1	PWM	HS/LS	12	Y	20-700	N	SOIC-16 NB	2.5 kV _{RMS}
Si8274GB1-IS1	Si8274GB1-AS1	PWM	HS/LS	3	N	10-200	Y	SOIC-16 NB	2.5 kV _{RMS}

Ordering Part Number	Automotive OPN ^{4, 5}	Inputs	Driver Configuration ⁶	Output UVLO (V)	Integrated Deglitcher	Dead-Time Range (ns)	Low Jitter	Package	Isolation Rating
Si8274GB4D-IS1	Si8274GB4D-AS1	PWM	HS/LS	3	Y	20-700	N	SOIC-16 NB	2.5 kV _{RMS}
Si8275AB-IS1	Si8275AB-AS1	VIA/VIB	Dual	5	N	N/A	Y	SOIC-16 NB	2.5 kV _{RMS}
Si8275ABD-IS1	Si8275ABD-AS1	VIA/VIB	Dual	5	Y	N/A	N	SOIC-16 NB	2.5 kV _{RMS}
Si8275BB-IS1	Si8275BB-AS1	VIA/VIB	Dual	8	N	N/A	Y	SOIC-16 NB	2.5 kV _{RMS}
Si8275BBD-IS1	Si8275BBD-AS1	VIA/VIB	Dual	8	Y	N/A	N	SOIC-16 NB	2.5 kV _{RMS}
Si8275DB-IS1	Si8275DB-AS1	VIA/VIB	Dual	12	N	N/A	Y	SOIC-16 NB	2.5 kV _{RMS}
Si8275DBD-IS1	Si8275DBD-AS1	VIA/VIB	Dual	12	Y	N/A	N	SOIC-16 NB	2.5 kV _{RMS}
Si8275GB-IS1	Si8275GB-AS1	VIA/VIB	Dual	3	N	N/A	Y	SOIC-16 NB	2.5 kV _{RMS}
Si8275GBD-IS1	Si8275GBD-AS1	VIA/VIB	Dual	3	Y	N/A	N	SOIC-16 NB	2.5 kV _{RMS}
Si8273AB-IM1	Si8273AB-AM1	VIA/VIB	HS/LS	5	N	N/A	Y	DFN-14	2.5 kV _{RMS}
Si8273ABD-IM1	Si8273ABD-AM1	VIA/VIB	HS/LS	5	Y	N/A	N	DFN-14	2.5 kV _{RMS}
Si8273GB-IM1	Si8273GB-AM1	VIA/VIB	HS/LS	3	N	N/A	Y	DFN-14	2.5 kV _{RMS}
Si8274AB1-IM1	Si8274AB1-AM1	PWM	HS/LS	5	N	10-200	Y	DFN-14	2.5 kV _{RMS}
Si8274AB4D-IM1	Si8274AB4D-AM1	PWM	HS/LS	5	Y	20-700	N	DFN-14	2.5 kV _{RMS}
Si8274GB1-IM1	Si8274GB1-AM1	PWM	HS/LS	3	N	10-200	Y	DFN-14	2.5 kV _{RMS}
Si8274GB4D-IM1	Si8274GB4D-AM1	PWM	HS/LS	3	Y	20-700	N	DFN-14	2.5 kV _{RMS}
Si8275AB-IM1	Si8275AB-AM1	VIA/VIB	Dual	5	N	N/A	Y	DFN-14	2.5 kV _{RMS}
Si8275ABD-IM1	Si8275ABD-AM1	VIA/VIB	Dual	5	Y	N/A	N	DFN-14	2.5 kV _{RMS}
Si8275BB-IM1	Si8275BB-AM1	VIA/VIB	Dual	8	N	N/A	Y	DFN-14	2.5 kV _{RMS}
Si8275BBD-IM1	Si8275BBD-AM1	VIA/VIB	Dual	8	Y	N/A	N	DFN-14	2.5 kV _{RMS}
Si8275DB-IM1	Si8275DB-AM1	VIA/VIB	Dual	12	N	N/A	Y	DFN-14	2.5 kV _{RMS}
Si8275DBD-IM1	Si8275DBD-AM1	VIA/VIB	Dual	12	Y	N/A	N	DFN-14	2.5 kV _{RMS}
Si8275GB-IM1	Si8275GB-AM1	VIA/VIB	Dual	3	N	N/A	Y	DFN-14	2.5 kV _{RMS}
Si8275GBD-IM1	Si8275GBD-AM1	VIA/VIB	Dual	3	Y	N/A	N	DFN-14	2.5 kV _{RMS}
1 kV_{RMS} Isolation Options									
Si8271GA-IS	Si8271GA-AS	VI	Single	3	N	N/A	Y	SOIC-8 NB	1 kV _{RMS}
Si8271GAD-IS	Si8271GAD-AS	VI	Single	3	Y	N/A	N	SOIC-8 NB	1 kV _{RMS}
Si8273GA-IM1	Si8273GA-AM1	VIA/VIB	HS/LS	3	N	N/A	Y	DFN-14	1 kV _{RMS}
Si8273GAD-IM1	Si8273GAD-AM1	VIA/VIB	HS/LS	3	Y	N/A	N	DFN-14	1 kV _{RMS}
Si8274GA1-IM1	Si8274GA1-AM1	PWM	HS/LS	3	N	10-200	Y	DFN-14	1 kV _{RMS}
Si8274GA1D-IM1	Si8274GA1D-AM1	PWM	HS/LS	3	Y	10-200	N	DFN-14	1 kV _{RMS}
Si8275GA-IM1	Si8275GA-AM1	VIA/VIB	Dual	3	N	N/A	Y	DFN-14	1 kV _{RMS}
Si8275GAD-IM1	Si8275GAD-AM1	VIA/VIB	Dual	3	Y	N/A	N	DFN-14	1 kV _{RMS}

Ordering Part Number	Automotive OPN ^{4, 5}	Inputs	Driver Configuration ⁶	Output UVLO (V)	Integrated Deglitcher	Dead-Time Range (ns)	Low Jitter	Package	Isolation Rating
Si8275DA-IM1	Si8275DA-AM1	VIA/VIB	Dual	12	N	N/A	Y	DFN-14	1 kV _{RMS}
Si8275DAD-IM1	Si8275DAD-AM1	VIA/VIB	Dual	12	Y	N/A	N	DFN-14	1 kV _{RMS}

Note:

1. All packages are RoHS-compliant with peak reflow temperatures of 260 °C according to the JEDEC industry standard classifications.
2. “Si” and “SI” are used interchangeably.
3. An “R” at the end of the Ordering Part Number indicates tape and reel option.
4. Automotive-Grade devices (with an “-A” suffix) are identical in construction materials and electrical parameters to their Industrial-Grade (with an “-I” suffix) version counterpart. Automotive-Grade products are produced utilizing full automotive process flows and additional statistical process controls throughout the manufacturing flow. The Automotive-Grade part number is included on shipping labels.
5. In Top Markings, the Manufacturing Code represented by “TTTTTT” contains, as its first character, a letter in the range N through Z to indicate Automotive-Grade.
6. All HS/LS drivers have built-in overlap protection while the single and dual drivers do not.

Table of Contents

1. Ordering Guide	2
2. System Overview	7
2.1 Typical Operating Characteristics	10
2.2 Family Overview and Logic Operation During Startup	11
2.2.1 Products	11
2.2.2 Device Behavior	11
2.3 Power Supply Connections	13
2.4 Power Dissipation Considerations	13
2.5 Layout Considerations	15
2.6 Undervoltage Lockout Operation	15
2.6.1 Device Startup	15
2.6.2 Undervoltage Lockout	16
2.6.3 Control Inputs	16
2.6.4 Enable Input	16
2.7 Overlap Protection and Programmable Dead Time	17
2.8 Deglitch Feature	18
3. Applications	19
3.1 High-Side/Low-Side Driver	19
3.2 Dual Driver	20
4. Electrical Specifications	21
4.1 Test Circuits	24
4.2 Regulatory Information (Pending)	25
5. Pin Descriptions	31
5.1 Si8271 Pin Descriptions	31
5.2 Si8273/75 Pin Descriptions	32
5.3 Si8274 Pin Descriptions	33
6. Package Outlines	34
6.1 Package Outline: 16-Pin Narrow-Body SOIC	34
6.2 Package Outline: 8-Pin Narrow Body SOIC	36
6.3 Package Outline: 14-Pin DFN	38
7. Land Patterns	39
7.1 Land Pattern: 16-Pin Narrow Body SOIC	39
7.2 Land Pattern: 8-Pin Narrow Body SOIC	40
7.3 Land Pattern: 14-Pin DFN	41
8. Top Markings	42
8.1 Si827x Top Marking (16-Pin Narrow Body SOIC)	42

8.2 Si8271 Top Marking (8-Pin Narrow Body SOIC)43
8.3 Si827x Top Marking (14-Pin DFN)44
9. Revision History	45

2. System Overview



Figure 2.1. Si8271 Block Diagram



Figure 2.2. Si8273 Block Diagram



Figure 2.3. Si8274 Block Diagram



Figure 2.4. Si8275 Block Diagram

The operation of an Si827x channel is analogous to that of an optocoupler and gate driver, except an RF carrier is modulated instead of light. This simple architecture provides a robust isolated data path and requires no special considerations or initialization at start-up. A simplified block diagram for a single Si827x channel is shown in the figure below.



Figure 2.5. Simplified Channel Diagram

A channel consists of an RF Transmitter and RF Receiver separated by a semiconductor-based isolation barrier. Referring to the Transmitter, input A modulates the carrier provided by an RF oscillator using on/off keying. The Receiver contains a demodulator that decodes the input state according to its RF energy content and applies the result to output B via the output driver. This RF on/off keying scheme is superior to pulse code schemes as it provides best-in-class noise immunity, low power consumption, and better immunity to magnetic fields. See [Figure 2.6 Modulation Scheme](#) on page 9 for more details.



Figure 2.6. Modulation Scheme

2.1 Typical Operating Characteristics

The typical performance characteristics depicted in the figures below are for information purposes only. Refer to [Table 4.1 Electrical Characteristics](#) on page 21 for actual specification limits.

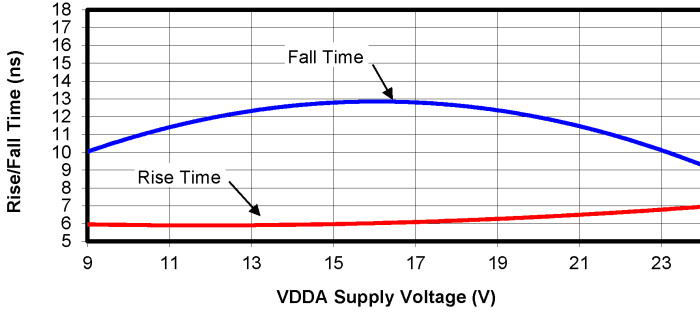

Figure 2.7. Rise/Fall Time vs. Supply Voltage

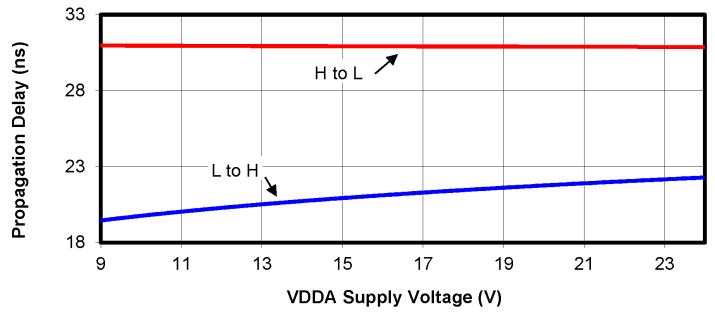

Figure 2.8. Propagation Delay vs. Supply Voltage

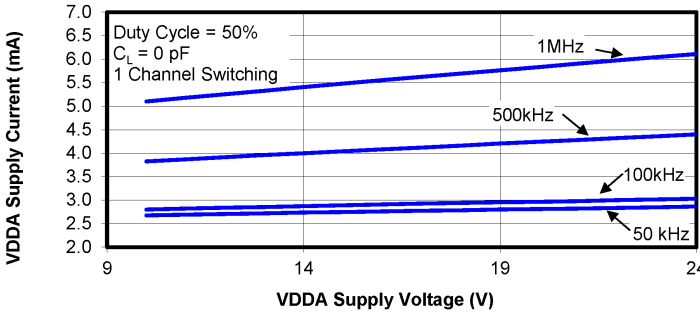

Figure 2.9. Supply Current vs. Supply Voltage

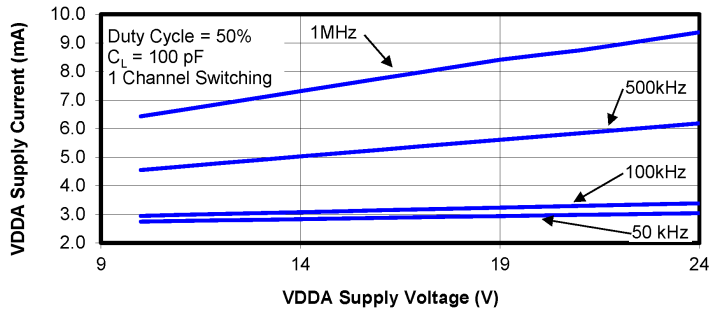

Figure 2.10. Supply Current vs. Supply Voltage

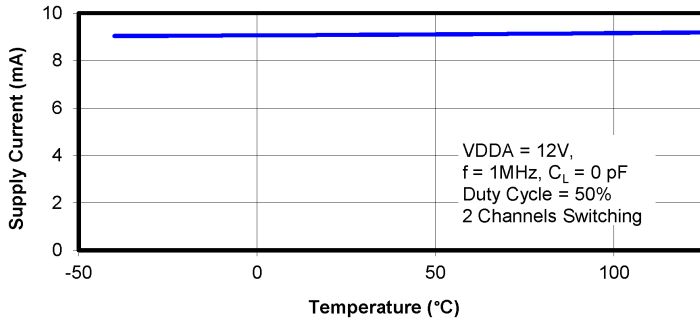

Figure 2.11. Supply Current vs. Temperature

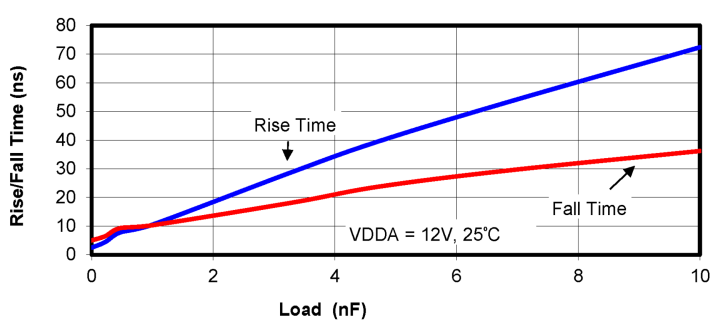

Figure 2.12. Rise/Fall Time vs. Load



Figure 2.13. Propagation Delay vs. Load

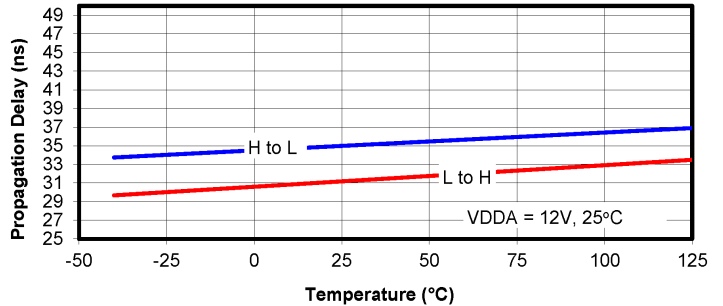

Figure 2.14. Propagation Delay vs. Temperature



Figure 2.15. Output Sink Current vs. Temperature



Figure 2.16. Output Source Current vs. Temperature

2.2 Family Overview and Logic Operation During Startup

The Si827x family of isolated drivers consists of single, high-side/low-side, and dual driver configurations.

2.2.1 Products

The table below shows the configuration and functional overview for each product in this family.

Table 2.1. Si827x Family Overview

Part Number	Configuration	Overlap Protection	Programmable Dead Time	Inputs	Peak Output Current (A)
Si8271	Single Driver	—	—	VI	4.0
Si8273	High-Side/Low-Side	Y	—	VIA, VIB	4.0
Si8274	PWM	Y	Y	PWM	4.0
Si8275	Dual Driver	—	—	VIA, VIB	4.0

2.2.2 Device Behavior

The following table consists of truth tables for the Si8273, Si8274, and Si8275 families.

Table 2.2. Si827x Family Truth Table¹

Si8271 (Single Driver) Truth Table						
Inputs		VDDI State	Enable	Output		Notes
VI				VO+	VO-	
L		Powered	H	Hi-Z	L	
H		Powered	H	H	Hi-Z	
X ²		Unpowered	X	Hi-Z	L	
X		Powered	L	Hi-Z	L	
Si8273 (High-Side/Low-Side) Truth Table						
Inputs		VDDI State	Enable	Output		Notes
VIA	VIB			VOA	VOB	
L	L	Powered	H	L	L	
L	H	Powered	H	L	H	
H	L	Powered	H	H	L	
H	H	Powered	H	L	L	Invalid state.
X ²	X ²	Unpowered	X	L	L	Output returns to input state within 7 μ s of VDDI power restoration.
X	X	Powered	L	L	L	Device is disabled.
Si8274 (PWM Input High-Side/Low-Side) Truth Table						
PWM Input		VDDI State	Enable	Output		Notes
				VOA	VOB	
H		Powered	H	H	L	
L		Powered	H	L	H	
X ²		Unpowered	X	L	L	Output returns to input state within 7 μ s of VDDI power restoration.
X		Powered	L	L	L	Device is disabled.
Si8275 (Dual Driver) Truth Table						
Inputs		VDDI State	Enable	Output		Notes
VIA	VIB			VOA	VOB	
L	L	Powered	H	L	L	
L	H	Powered	H	L	H	
H	L	Powered	H	H	L	
H	H	Powered	H	H	H	
X ²	X ²	Unpowered	X	L	L	Output returns to input state within 7 μ s of VDDI power restoration.
X	X	Powered	L	L	L	Device is disabled.

1. This truth table assumes VDDA and VDDB are powered. If VDDA and VDDB are below UVLO, see [2.6.2 Undervoltage Lockout](#) for more information.

2. An input can power the input die through an internal diode if its source has adequate current.

2.3 Power Supply Connections

Isolation requirements mandate individual supplies for VDDI, VDDA, and VDDB. The decoupling caps for these supplies must be placed as close to the VDD and GND pins of the Si827x as possible. The optimum values for these capacitors depend on load current and the distance between the chip and the regulator that powers it. Low effective series resistance (ESR) capacitors, such as Tantalum, are recommended.

2.4 Power Dissipation Considerations

Proper system design must assure that the Si827x operates within safe thermal limits across the entire load range. The Si827x total power dissipation is the sum of the power dissipated by bias supply current, internal parasitic switching losses, and power dissipated by the series gate resistor and load. The equation below shows total Si827x power dissipation.

$$P_D = (VDDI)(IDDI) + 2(IDDx)(VDDx) + (f)(Q_G)\left(VDDx\right)\left[\frac{R_P}{R_P + R_G}\right] + (f)(Q_G)\left(VDDx\right)\left[\frac{R_N}{R_N + R_G}\right] + 2fC_{INT}VDDx^2$$

where:

P_D is the total Si827x device power dissipation (W)

IDDI is the input-side maximum bias current (10 mA)

IDDx is the driver die maximum bias current (4 mA)

C_{INT} is the internal parasitic capacitance (370 pF)

VDDI is the input-side VDD supply voltage (2.5 to 5.5 V)

VDDx is the driver-side supply voltage (4.2 to 30 V)

f is the switching frequency (Hz)

Q_G is the gate charge of the external FET

R_G is the external gate resistor

R_P is the $R_{DS(ON)}$ of the driver pull-up switch (2.7 Ω)

R_N is the $R_{DS(ON)}$ of the driver pull-down switch (1 Ω)

Equation 1

For example, the total power dissipation for an application can be found using Equation 1 and the following application-specific values:

$$VDDI = 5.0 \text{ V}$$

$$VDDx = 12 \text{ V}$$

$$f = 350 \text{ kHz}$$

$$R_G = 22 \text{ } \Omega$$

$$Q_G = 25 \text{ nC}$$

With these application-specific values, Equation 1 yields $P_D = 199 \text{ mW}$.

The driver junction temperature is calculated using Equation 2, shown below.

$$T_J = P_D \times \theta_{JA} + T_A$$

where:

P_D is the total Si827x device power dissipation (W), as determined by Equation 1.

θ_{JA} is the thermal resistance from junction to air (°C/W)

T_A is the ambient temperature (°C)

Equation 2

Continuing the example above, the driver junction temperature can be determined using the result of Equation 1 and Equation 2 with the following application-specific values:

$$\theta_{JA} = 66 \text{ °C/W}$$

$$T_A = 20 \text{ °C}$$

With these application-specific values, Equation 2 yields $T_J = 33.1 \text{ °C}$.

The maximum power dissipation allowable for the Si827x, for any given application, is a function of the package thermal resistance, ambient temperature, and maximum allowable junction temperature, as shown in Equation 3 below.

$$P_{D(\text{MAX})} \leq \frac{T_{J(\text{MAX})} - T_A}{\theta_{JA}}$$

where:

$P_{D(\text{MAX})}$ is the maximum Si827x power dissipation (W)

$T_{J(\text{MAX})}$ is the maximum Si827x junction temperature (150 °C)

T_A is the ambient temperature (°C)

θ_{JA} is the Si827x junction-to-air thermal resistance (°C/W)

Equation 3

Continuing our example from the previous page and using the results of Equation 1 and Equation 2 as inputs to Equation 3, along with the example values of T_A and θ_{JA} previously given, yields a maximum allowable power dissipation of 1.97 W.

Maximum allowable gate charge as a function of switching frequency is found by substituting the maximum allowable power dissipation limit and the appropriate data sheet values from [Table 4.1 Electrical Characteristics on page 21](#) into Equation 1 and simplifying. For our example, the result is Equation 4, which assumes $V_{DDI} = 5$ V and $V_{DDA} = V_{ddb} = 12$ V, and can be easily charted to visualize design constraints as is demonstrated by Figure 2.17 below.

$$Q_{G(MAX)} = \frac{0.995}{f} - 1.06 \times 10^{-7}$$

Equation 4



Figure 2.17. Maximum Gate Charge vs. Switching Frequency

2.5 Layout Considerations

It is most important to minimize ringing in the drive path and noise on the Si827x VDD lines. Care must be taken to minimize parasitic inductance in these paths by locating the Si827x as close to the device it is driving as possible. In addition, the VDD supply and ground trace paths must be kept short. For this reason, the use of power and ground planes is highly recommended. A split ground plane system having separate ground and VDD planes for power devices and small signal components provides the best overall noise performance.

2.6 Undervoltage Lockout Operation

Device behavior during start-up, normal operation and shutdown is shown in the [Figure 2.18 on page 16](#), where UVLO+ and UVLO- are the positive-going and negative-going thresholds respectively.

It's important to note that the driver outputs (VO) will default to a low output state when the input side power supply (VDDI) is not present, but the output side power supply (VDDx) is present.

2.6.1 Device Startup

Driver outputs (VO) are held low during power-up until the device power supplies are above the UVLO threshold for time period t_{START} . Following this, the outputs follow the state of device inputs (VI).

2.6.2 Undervoltage Lockout

Undervoltage Lockout (UVLO) is provided to prevent erroneous operation during device startup and shutdown or when the device power supplies are below their specified operating circuits range. The input (control) side, and each driver on the output side, have their own undervoltage lockout monitors.

The Si827x input side enters UVLO when $VDDI < VDDI_{UV-}$, and exits UVLO when $VDDI > VDDI_{UV+}$. The driver output (VO) remains low when the input side of the Si827x is in UVLO and VDDx is within tolerance. Each driver output can enter or exit UVLO independently. For example, VOA unconditionally enters UVLO when $VDDA$ falls below $VDDA_{UV-}$ and exits UVLO when $VDDA$ rises above $VDDA_{UV+}$.

The UVLO circuit unconditionally drives VO low when VDDx is below the lockout threshold. Upon power up, the Si827x is maintained in UVLO until VDDx rises above $VDDx_{UV+}$. During power down, the Si827x enters UVLO when VDDx falls below $VDDx_{UV-}$. Please refer to spec tables for UVLO values.

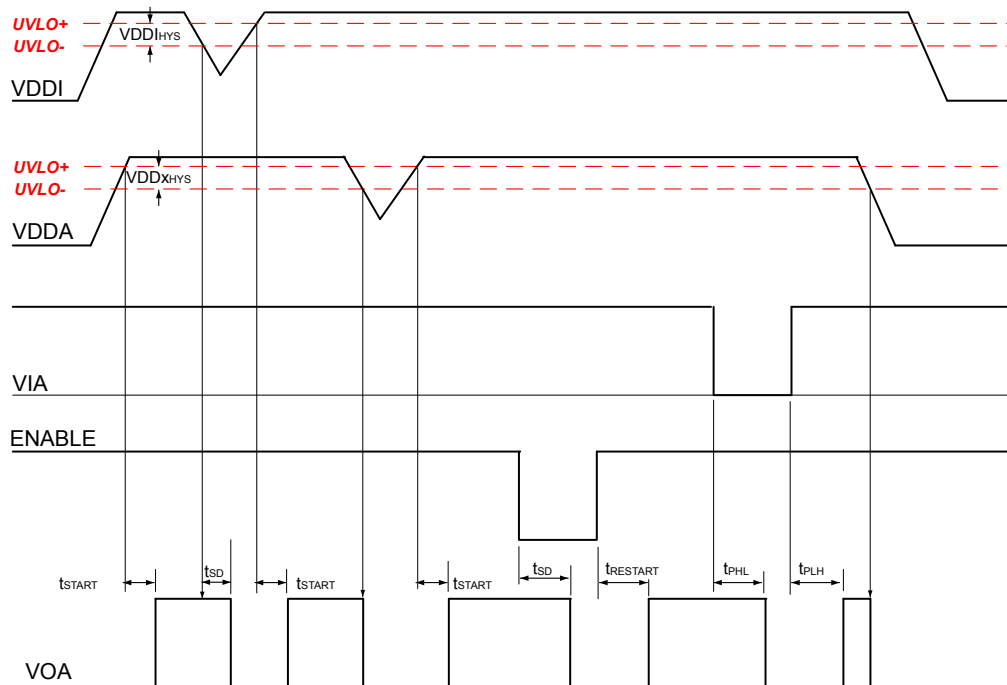

Figure 2.18. Device Behavior during Normal Operation and Shutdown

2.6.3 Control Inputs

VIA, VIB, and PWM inputs are high-true, TTL level-compatible logic inputs. A logic high signal on VIA or VIB causes the corresponding output to go high. For PWM input versions (Si8274), VOA is high and VOB is low when the PWM input is high, and VOA is low and VOB is high when the PWM input is low.

2.6.4 Enable Input

When brought low, the ENABLE input unconditionally drives VOA and VOB low regardless of the states of VIA and VIB. Device operation terminates within t_{SD} after $ENABLE = V_{IL}$ and resumes within $t_{RESTART}$ after $ENABLE = V_{IH}$. The ENABLE input has no effect if VDDI is below its UVLO level (i.e., VOA, VOB remain low).

2.7 Overlap Protection and Programmable Dead Time

Overlap protection prevents the two driver outputs from both going high at the same time. Programmable dead time control sets the amount of time between one output going low and the other output going high.

All drivers configured as high-side/low-side pairs with separate inputs (Si8273x) have overlap protection. See [Figure 2.19 on page 17](#) and [Table 2.3 on page 17](#). Drivers controlled with a single input (Si8274x) have inherit overlap protection by virtue of one driver being active high and the other being active low with respect to the PWM input.



Figure 2.19. Input and Output Waveforms for Si8273x Drivers

Table 2.3. Description of Input and Output Waveforms for Si8273x Drivers

Reference	Description
A	Normal operation: VIA high, VIB low.
B	Normal operation: VIB high, VIA low.
C	Contention: VIA = VIB = high.
D	Recovery from contention: VIA transitions low.
E	Normal operation: VIA = VIB = low.
F	Normal operation: VIA high, VIB low.
G	Contention: VIA = VIB = high.
H	Recovery from contention: VIB transitions low.
I	Normal operation: VIB transitions high.

All high-side/low-side drivers with a single PWM input (Si8274x) include programmable dead time, which adds a user-programmable delay between transitions of VOA and VOB. When enabled, dead time is present on all transitions. The amount of dead time delay (DT) is programmed by a single resistor (RDT) connected from the DT input to ground per the equation below. Note that the dead time pin should be connected to GNDI through a resistor between the values of 6 k Ω and 100 k Ω . A filter capacitor of 100 pF in parallel with RDT is recommended. See [Figure 2.20 on page 18](#) below.

$$DT = 2.02 \times RDT + 7.77 \text{ (for 10–200 ns range)}$$

$$DT = 6.06 \times RDT + 3.84 \text{ (for 20–700 ns range)}$$

where:

DT is the dead time (ns)

RDT is the dead time programming resistor (k Ω)

Equation 4



Figure 2.20. Dead-Time Waveforms for Si8274x Drivers

2.8 Deglitch Feature

A deglitch feature is provided on some options, as defined in the [1. Ordering Guide](#). The internal deglitch circuit provides an internal time delay of 15 ns typical, during which any noise is ignored and will not pass through the IC. For these product options, the propagation delay will be extended by 15 ns, as specified in the spec table.

3. Applications

The following examples illustrate typical circuit configurations using the Si827x.

3.1 High-Side/Low-Side Driver

In the figure below, side A shows the Si8273 controlled using the VIA and VIB input signals, and side B shows the Si8274 controlled by a single PWM signal.



Figure 3.1. Si827x in Half-Bridge Application

For both cases, D1 and CB form a conventional bootstrap circuit that allows VOA to operate as a high-side driver for Q1, which has a maximum drain voltage of 1500 V. VOB is connected as a conventional low-side driver. Note that the input side of the Si827x requires VDDI in the range of 2.5 to 5.5 V, while the VDDA and VDDB output side supplies must be between 4.2 and 30 V with respect to their respective grounds. The boot-strap start up time will depend on the CB capacitor chosen. VDD is usually the same as VDDB. Also, note that the bypass capacitors on the Si827x should be located as close to the chip as possible. Moreover, it is recommended that bypass capacitors be used (as shown in the figures above for input and driver side) to reduce high frequency noise and maximize performance. The outputs VOA and VOB can be used interchangeably as high side or low side drivers.

3.2 Dual Driver

The figure below shows the Si827x configured as a dual driver. Note that the drain voltages of Q1 and Q2 can be referenced to a common ground or to different grounds with as much as 1500 V dc between them.



Figure 3.2. Si827x in a Dual Driver Application

Because each output driver resides on its own die, the relative voltage polarities of VOA and VOB can reverse without damaging the driver. That is, the voltage at VOA can be higher or lower than that of VOB by VDD without damaging the driver. Therefore, a dual driver in a high-side/low-side drive application can use either VOA or VOB as the high side driver. Similarly, a dual driver can operate as a dual low-side or dual high-side driver and is unaffected by static or dynamic voltage polarity changes.

4. Electrical Specifications

Table 4.1. Electrical Characteristics

VDDI = 2.5 to 5.5 V; VDDx - GNDx = 4.2 to 30 V; T_A = -40 to +125 °C

Typical specifications at VDDI = 5 V; VDDx - GNDx = 15 V; T_A = 25 °C unless otherwise noted

Parameter	Symbol	Test Condition	Min	Typ	Max	Units
DC Parameters						
Input Supply Voltage	VDDI	VDDI – GNDI	2.5	—	5.5	V
Driver Supply Voltage	VDDx ¹	VDDx – GNDx	4.2	—	30	V
Input Supply Quiescent Current	IDD _Q		—	7.9	10.0	mA
Input Supply Active Current	IDDI	f = 500 kHz	—	8.0	10.0	mA
Output Supply Quiescent Current	IDDx _Q ²		—	2.5	4.0	mA
Output Supply Active Current	IDDx ²	f = 500 kHz (no load)	—	10.0	11.0	mA
Gate Driver						
High Output Transistor RDS (ON)	R _{OH}		—	2.7	—	Ω
Low Output Transistor RDS (ON)	R _{OL}		—	1.0	—	Ω
High Level Peak Output Current	I _{OH}	VDDx = 15 V, See Figure 4.2 on page 24 for Si827xG, VDDx = 4.2 V, t _{PW_IOH} < 250 ns	—	1.8	—	A
Low Level Peak Output Current	I _{OL}	VDDx = 15 V, See Figure 4.1 on page 24 for Si827xG, VDDx = 4.2 V, t _{PW_IOL} < 250 ns	—	4.0	—	A
UVLO						
VDDI UVLO Threshold +	VDDI _{UV+}		1.85	2.2	2.45	V
VDDI UVLO Threshold –	VDDI _{UV–}		1.75	2.1	2.35	V
VDDI Hysteresis	VDDI _{HYS}		—	100	—	mV
UVLO Threshold + (Driver Side)						
3 V Threshold	VDDx _{UV+} ¹		2.7	3.5	4.0	V
5 V Threshold			4.9	5.5	6.3	V
8 V Threshold			7.2	8.3	9.5	V
12 V Threshold			11	12.2	13.5	V
UVLO Threshold - (Driver Side)						

Parameter	Symbol	Test Condition	Min	Typ	Max	Units
3 V Threshold	VDD _{XUV} ¹		2.5	3.0	3.8	V
5 V Threshold			4.6	5.2	5.9	V
8 V Threshold			6.7	7.8	8.9	V
12 V Threshold			9.6	10.8	12.1	V
UVLO Lockout Hysteresis						
3 V Threshold	VDD _{XHYS}		—	500	—	mV
5 V Threshold			—	300	—	mV
8 V Threshold			—	500	—	mV
12 V Threshold			—	1400	—	mV
Digital						
Logic High Input Threshold	V _{IH}		2.0	—	—	V
Logic Low Input Threshold	V _{IL}		—	—	0.8	V
Input Hysteresis	V _{HYST}		350	400	—	mV
Logic High Output Voltage	V _{OH}	I _O = -1 mA	VDDx - 0.04	—	—	V
Logic Low Output Voltage	V _{OL}	I _O = 1 mA	—	—	0.04	V
AC Switching Parameters						
Propagation Delay Si8271/3/5 with low jitter	t _{PLH} , t _{PHL}	C _L = 200 pF	20	30	60	ns
Propagation Delay Si8271/3/5 with deglitch option	t _{PLH} , t _{PHL}	C _L = 200 pF	30	45	75	ns
Propagation Delay Si8274 with low jitter	t _{PHL}	C _L = 200 pF	20	30	60	ns
Propagation Delay Si8274 with deglitch option	t _{PHL}	C _L = 200 pF	30	45	75	ns
Propagation Delay Si8274 with low jitter	t _{PLH}	C _L = 200 pF	30	45	75	ns
Propagation Delay Si8274 with deglitch option	t _{PLH}	C _L = 200 pF	65	85	105	ns
Pulse Width Distortion Si8271/3/5 all options	PWD	t _{PLH} - t _{PHL}	—	3.6	8	ns
Pulse Width Distortion Si8274 with low jitter	PWD	t _{PLH} - t _{PHL}	—	14	19	ns
Pulse Width Distortion Si8274 with deglitch option	PWD	t _{PLH} - t _{PHL}	—	38	47	ns
Peak to Peak Jitter Si827x with low jitter	t _{JIT(PK)}		—	200	—	ps

Parameter	Symbol	Test Condition	Min	Typ	Max	Units
Programmed dead time (DT) for products with 10–200 ns DT range	DT	RDT = 6 k Ω	10	20	30	ns
		RDT = 15 k Ω	26	38	50	
		RDT = 100 k Ω	150	210	260	
Programmed dead time (DT) for products with 20–700 ns DT range	DT	RDT = 6 k Ω	23	40	57	ns
		RDT = 15 k Ω	60	95	130	
		RDT = 100 k Ω	450	610	770	
Rise time	t_R	CL = 200 pF	4	10.5	16	ns
Fall time	t_F	CL = 200 pF	5.5	13.3	18	ns
Shutdown Time from Enable False	t_{SD}		—	—	60	ns
Restart Time from Enable True	$t_{RESTART}$		—	—	60	ns
Device Startup Time	t_{START}		—	16	30	μ s
Common Mode Transient Immunity Si827x with deglitch option	CMTI	See Figure 4.3 on page 25 . VCM = 1500 V	200	350	400	kV/ μ s
Common Mode Transient Immunity Si827x with low jitter option	CMTI	See Figure 4.3 on page 25 . VCM = 1500 V	150	300	400	kV/ μ s

Notes:

1. The symbols VDD, VDDA and VDDB all refer to the driver supply voltage, but reflect the different pin names used for the supply on different product options. Specifications that apply to the driver supply voltage are also referred to as VDDx in this data sheet.
2. The symbols IDD, IDDA and IDDB all refer to the driver supply current, but reflect the different pin names used for the supply on different product options. Specifications that apply to the driver supply current are also referred to as IDDX in this data sheet.

4.1 Test Circuits

The figures below depict sink current, source current, and common-mode transient immunity test circuits.



Figure 4.1. IOL Sink Current Test Circuit



Figure 4.2. IOH Source Current Test Circuit



Figure 4.3. Common Mode Transient Immunity Test Circuit

4.2 Regulatory Information (Pending)

Table 4.2. Regulatory Information^{1,2}

CSA
The Si827x is certified under CSA. For more details, see Master Contract Number 232873.
60950-1: Up to 125 V _{RMS} reinforced insulation working voltage; up to 600 V _{RMS} basic insulation working voltage.
VDE
The Si827x is certified according to VDE 0884-10. For more details, see Certificate 40018443.
VDE 0884-10: Up to 630 V _{peak} for basic insulation working voltage.
UL
The Si827x is certified under UL1577 component recognition program. For more details, see File E257455.
Rated up to 2500 V _{RMS} isolation voltage for basic protection.
CQC
The Si827x is certified under GB4943.1-2011. For more details, see Certificates CQC 16001160284 and CQC 17001177887.
Rated up to 250 V _{RMS} basic insulation working voltage.
1. Regulatory Certifications apply to 2.5 kV _{RMS} rated devices which are production tested to 3.0 kV _{RMS} for 1 sec.
2. For more information, see 1. Ordering Guide .

Table 4.3. Insulation and Safety-Related Specifications

Parameter	Symbol	Test Condition	Value			Unit
			SOIC-8	NB SOIC-16	DFN-14	
Nominal External Air Gap (Clearance)	CLR		4.7	4.7	3.5	mm
Nominal External Tracking (Creepage)	CPG		3.9	3.9	3.5	mm
Minimum Internal Gap (Internal Clearance)	DTI		0.008	0.008	0.008	mm
Tracking Resistance	PTI or CTI	IEC60112	600	600	600	V
Erosion Depth	ED		0.019	0.019	0.021	mm
Resistance (Input-Output) ¹	R _{IO}		10 ¹²	10 ¹²	10 ¹²	Ω
Capacitance (Input-Output) ¹	C _{IO}	f = 1 MHz	0.5	0.5	0.5	pF
Input Capacitance ²	C _I		3.0	3.0	3.0	pF

Notes:

1. To determine resistance and capacitance, the Si827x is converted into a 2-terminal device. All pins on side 1 are shorted to create terminal 1, and all pins on side 2 are shorted to create terminal 2. The parameters are then measured between these two terminals.
2. Measured from input pin to ground.

Table 4.4. IEC 60664-1 Ratings

Parameter	Test Condition	Specification		
		SOIC-8	NB SOIC-16	DFN-14
Basic Isolation Group	Material Group	I	I	I
Installation Classification	Rated Mains Voltages < 150 V _{RMS}	I-IV	I-IV	I-IV
	Rated Mains Voltages < 300 V _{RMS}	I-III	I-III	I-III
	Rated Mains Voltages < 400 V _{RMS}	I-II	I-II	I-II
	Rated Mains Voltages < 600 V _{RMS}	I-II	I-II	I-II

Table 4.5. VDE 0884 Insulation Characteristics¹

Parameter	Symbol	Test Condition	Characteristic	Unit
Maximum Working Insulation Voltage	V_{IORM}		630	V peak
Input to Output Test Voltage	V_{PR}	Method b1 ($V_{IORM} \times 1.875 = V_{PR}$, 100% Production Test, $t_m = 1$ sec, Partial Discharge < 5 pC)	1181	V peak
Transient Overvoltage	V_{IOTM}	$t = 60$ sec	4000	V peak
Surge Voltage	V_{IOSM}	Tested per IEC 60065 with surge voltage of 1.2 μ s/50 μ s Tested with 4000 V	3077	Vpeak
Pollution Degree (DIN VDE 0110, Table 1)			2	
Insulation Resistance at T_S , $V_{IO} = 500$ V	R_S		$>10^9$	Ω

Note:
1. Maintenance of the safety data is ensured by protective circuits. The Si827x provides a climate classification of 40/125/21.

Table 4.6. IEC Safety Limiting Values¹

Parameter	Symbol	Test Condition	SOIC-8	NB SOIC-16	DFN-14	Unit
Safety Temperature	T_S		150	150	150	$^{\circ}$ C
Safety Input Current	I_S	$\theta_{JA} =$ 115 $^{\circ}$ C/W (SOIC-8), 66 $^{\circ}$ C/W (NB SOIC-16), 110 $^{\circ}$ C/W (DFN-14), VDDI = 5.5 V VDDx = 30 V $T_J =$ 150 $^{\circ}$ C $T_A =$ 25 $^{\circ}$ C	36	63	38	mA
Device Power Dissipation	P_D		1.1	1.2	1.2	W

Note:
1. Maximum value allowed in the event of a failure. Refer to the thermal derating curve in the two figures below.

Table 4.7. Thermal Characteristics

Parameter	Symbol	SOIC-8	NB SOIC-16	DFN-14	Unit
IC Junction-to-Air Thermal Resistance	θ_{JA}	115	66	110	$^{\circ}\text{C}/\text{W}$



Figure 4.4. NB SOIC-8 Thermal Derating Curve, Dependence of Safety Limiting Values per VDE



Figure 4.5. NB SOIC-16 Thermal Derating Curve, Dependence of Safety Limiting Values per VDE



Figure 4.6. DFN-14 Thermal Derating Curve, Dependence of Safety Limiting Values per VDE

Table 4.8. Absolute Maximum Ratings¹

Parameter	Symbol	Min	Max	Units
Storage Temperature	T_{STG}	-65	+150	°C
Operating Temperature	T_A	-40	+125	°C
Junction Temperature	T_J	—	+150	°C
Input-side supply voltage	VDDI	-0.6	6.0	V
Driver-side supply voltage	VDD, VDDA, VDDB	-0.6	36	V
Voltage on any input pin with respect to ground	VI, VIA, VIB, EN, DT	-0.5	VDD + 0.5	V
Voltage on any input pin with respect to ground ²	VO+, VO-, VOA, VOB	-0.5	VDD + 0.5	V
	VO+, VO-, VOA, VOB Transient for 200 ns	-1.2		
Peak Output Current ($t_{PW} = 10 \mu s$, duty cycle = 0.2%)	I_{OPK}	—	4.0	A
Lead Solder Temperature (10 s)		—	260	°C
HBM Rating ESD		—	3.5	kV
CDM		—	2000	V
Maximum Isolation Voltage (Input to Output) (1 sec) NB SOIC-16 and SOIC-8		—	3000	V_{RMS}
Maximum Isolation Voltage (Input to Output) (1 sec) DFN-14		—	3000	V_{RMS}
Maximum Isolation Voltage (Output to Output) (1 sec) NB SOIC-16		—	1500	V_{RMS}
Maximum Isolation Voltage (Output to Output) (1 sec) DFN-14		—	650	V_{RMS}
Latch-up Immunity		—	400	kV/ μs
Note:				
1. Permanent device damage may occur if the absolute maximum ratings are exceeded. Functional operation should be restricted to the conditions specified in the operational sections of this data sheet.				
2. Transient voltage pulse repeatable at 200 kHz.				

5. Pin Descriptions

5.1 Si8271 Pin Descriptions



Figure 5.1. Pin Assignments Si8271

Table 5.1. Si8271 Pin Descriptions

Pin	Name	Description
1	VI	Digital driver control signal
2	VDDI	Input side power supply
3	GNDI	Input side ground
4	EN	Enable
5	GND	Driver side ground
6	VO-	Gate drive pull low
7	VO+	Gate drive pull high
8	VDD	Driver side power supply

5.2 Si8273/75 Pin Descriptions

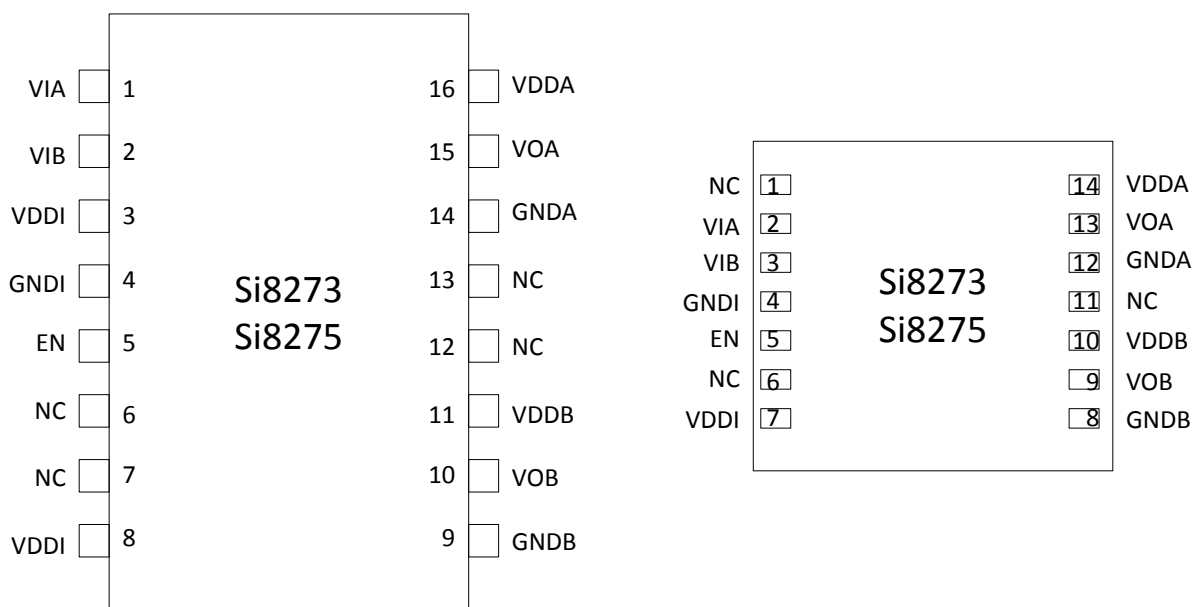

Figure 5.2. Pin Assignments Si8273/5

Table 5.2. Si8273/5 Pin Descriptions

NB SOIC-16 Pin #	DFN-14 Pin #	Name	Description
1	2	VIA	Digital driver control signal for "A" driver
2	3	VIB	Digital driver control signal for "B" driver
3,8	7	VDDI	Input side power supply
4	4	GNDI	Input side ground
5	5	EN	Enable
6, 7, 12, 13	1, 6, 11	NC	No Connect
9	8	GNDB	Driver side power supply for "B" driver
10	9	VOB	Gate drive output for "B" driver
11	10	VDDB	Driver side power supply for "B" driver
14	12	GNDA	Driver side power supply for "A" driver
15	13	VOA	Gate drive output for "A" driver
16	14	VDDA	Driver side power supply for "A" driver

5.3 Si8274 Pin Descriptions



Figure 5.3. Pin Assignments Si8274

Table 5.3. Si8274 Pin Descriptions

NB SOIC-16 Pin #	DFN-14 Pin #	Name	Description
1	2	PWM	Pulse width modulated driver control signal
2, 7, 12, 13	1, 3, 11	NC	No Connect
3, 8	7	VDDI	Input side power supply
4	4	GNDI	Input side ground
5	5	EN	Enable
6	6	DT	Dead-time control
9	8	GNDB	Driver side power supply for “B” driver
10	9	VOB	Gate drive output for “B” driver
11	10	VDDB	Driver side power supply for “B” driver
14	12	GNDA	Driver side power supply for “A” driver
15	13	VOA	Gate drive output for “A” driver
16	14	VDDA	Driver side power supply for “A” driver

6. Package Outlines

6.1 Package Outline: 16-Pin Narrow-Body SOIC

The figure below illustrates the package details for the Si827x in a 16-pin narrow-body SOIC (SO-16). The table below lists the values for the dimensions shown in the illustration.



Figure 6.1. 16-pin Small Outline Integrated Circuit (SOIC) Package

Table 6.1. Package Diagram Dimensions

Dimension	Min	Max	Dimension	Min	Max
A	—	1.75	L	0.40	1.27
A1	0.10	0.25	L2	0.25 BSC	
A2	1.25	—	h	0.25	0.50
b	0.31	0.51	θ	0°	8°
c	0.17	0.25	aaa	0.10	
D	9.90 BSC		bbb	0.20	
E	6.00 BSC		ccc	0.10	
E1	3.90 BSC		ddd	0.25	
e	1.27 BSC				

1. All dimensions shown are in millimeters (mm) unless otherwise noted.
2. Dimensioning and Tolerancing per ANSI Y14.5M-1994.
3. This drawing conforms to the JEDEC Solid State Outline MS-012, Variation AC.
4. Recommended card reflow profile is per the JEDEC/IPC J-STD-020 specification for Small Body Components.

6.2 Package Outline: 8-Pin Narrow Body SOIC

The figure below illustrates the package details for the Si827x in an 8-pin narrow-body SOIC package. The table below lists the values for the dimensions shown in the illustration.



Figure 6.2. 8-Pin Narrow Body SOIC Package

Table 6.2. 8-Pin Narrow Body SOIC Package Diagram Dimensions

Symbol	Millimeters	
	Min	Max
A	1.35	1.75
A1	0.10	0.25
A2	1.40 REF	1.55 REF
B	0.33	0.51
C	0.19	0.25
D	4.80	5.00
E	3.80	4.00
e	1.27 BSC	
H	5.80	6.20
h	0.25	0.50
L	0.40	1.27
α	0°	8°

6.3 Package Outline: 14-Pin DFN

The figure below illustrates the package details for the Si827x in an DFN outline. The table below lists the values for the dimensions shown in the illustration.



Figure 6.3. Si827x 14-pin DFN Outline

Table 6.3. Package Diagram Dimensions

Dimension	MIN	NOM	MAX
A	0.74	0.85	0.90
A1	0	—	0.05
b	0.25	0.30	0.35
D	4.90	5.00	5.10
e	0.65 BSC		
E	4.90	5.00	5.10
E1	3.60 REF		
L	0.50	0.60	0.70
L1	0.05	0.10	0.15
ccc	—	—	0.08
ddd	—	—	0.10

1. All dimensions shown are in millimeters (mm) unless otherwise noted.
2. Dimensioning and Tolerancing per ANSI Y14.5M-1994.

7. Land Patterns

7.1 Land Pattern: 16-Pin Narrow Body SOIC

The figure below illustrates the recommended land pattern details for the Si827x in a 16-pin narrow-body SOIC. The table below lists the values for the dimensions shown in the illustration.



Figure 7.1. 16-Pin Narrow Body SOIC PCB Land Pattern

Table 7.1. 16-Pin Narrow Body SOIC Land Pattern Dimensions

Dimension	Feature	(mm)
C1	Pad Column Spacing	5.40
E	Pad Row Pitch	1.27
X1	Pad Width	0.60
Y1	Pad Length	1.55

Notes:

1. This Land Pattern Design is based on IPC-7351 pattern SOIC127P600X165-16N for Density Level B (Median Land Protrusion).
2. All feature sizes shown are at Maximum Material Condition (MMC) and a card fabrication tolerance of 0.05 mm is assumed.

7.2 Land Pattern: 8-Pin Narrow Body SOIC

The figure below illustrates the recommended land pattern details for the Si827x in an 8-pin narrow-body SOIC. The table below lists the values for the dimensions shown in the illustration.



Figure 7.2. 8-Pin Narrow Body SOIC Land Pattern

Table 7.2. 8-Pin Narrow Body SOIC Land Pattern Dimensions

Dimension	Feature	(mm)
C1	Pad Column Spacing	5.40
E	Pad Row Pitch	1.27
X1	Pad Width	0.60
Y1	Pad Length	1.55

Notes:

1. This Land Pattern Design is based on IPC-7351 pattern SOIC127P600X173-8N for Density Level B (Median Land Protrusion).
2. All feature sizes shown are at Maximum Material Condition (MMC) and a card fabrication tolerance of 0.05 mm is assumed.

7.3 Land Pattern: 14-Pin DFN

The figure below illustrates the recommended land pattern details for the Si827x in a 14-pin DFN. The table below lists the values for the dimensions shown in the illustration.



Figure 7.3. 14-Pin DFN Land Pattern

Table 7.3. 14-Pin DFN Land Pattern Dimensions

Dimension	(mm)
C1	4.20
E	0.65
X1	0.80
Y1	0.40

Notes:

1. All dimensions shown are in millimeters (mm).
2. This Land Pattern Design is based on the IPC-7351 guidelines.
3. All dimensions shown are at Maximum Material Condition (MMC). Least Material Condition (LMC) is calculated based on a Fabrication Allowance of 0.05 mm.
4. All metal pads are to be non-solder mask defined (NSMD). Clearance between the solder mask and the metal pad is to be 60 μm minimum, all the way around the pad.
5. A stainless steel, laser-cut and electro-polished stencil with trapezoidal walls should be used to assure good solder paste release.
6. The stencil thickness should be 0.125 mm (5 mils).
7. The ratio of stencil aperture to land pad size should be 1:1.
8. A No-Clean, Type-3 solder paste is recommended.
9. The recommended card reflow profile is per the JEDEC/IPC J-STD-020 specification for Small Body Components.

8. Top Markings

8.1 Si827x Top Marking (16-Pin Narrow Body SOIC)

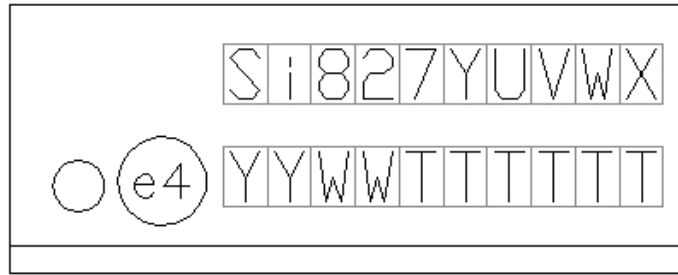

Table 8.1. Top Marking Explanation (16-Pin Narrow Body SOIC)

<p>Line 1 Marking:¹</p>	<p>Base Part Number</p> <p>Ordering Options</p> <p>See 1. Ordering Guide for more information.</p>	<p>Si827 = ISOdriver product series</p> <p>Y = Configuration</p> <p>3 = High-side/Low-side (HS/LS)</p> <p>4 = PWM HS/LS</p> <p>5 = Dual driver</p> <p>U = UVLO level</p> <p>G = 3 V</p> <p>A = 5 V</p> <p>B = 8 V</p> <p>D = 12 V</p> <p>V = Isolation rating</p> <p>B = 2.5 kV</p> <p>W = Dead-time setting range</p> <p>none = not included</p> <p>1= 10-200 ns</p> <p>4 = 20-700 ns</p> <p>X = Integrated deglitch circuit</p> <p>none = not included</p> <p>D = integrated</p>
<p>Line 2 Marking:</p>	<p>YY = Year</p> <p>WW = Workweek</p>	<p>Assigned by the Assembly House. Corresponds to the year and workweek of the mold date.</p>
	<p>TTTTTT = Mfg Code</p>	<p>Manufacturing Code from Assembly Purchase Order form. The Manufacturing Code represented by “TTTTTT” contains, as its first character, a letter in the range N through Z to indicate Automotive-Grade.</p>
<p>Note:</p> <p>1. Characters W and/or X are optional and may be missing from the marking line. When missing, the remaining characters are right-justified on the marking line.</p>		

8.2 Si8271 Top Marking (8-Pin Narrow Body SOIC)



Table 8.2. Top Marking Explanation (Narrow Body SOIC)

Line 1 Marking:	Customer Part Number	Si827 = ISOdriver product series Y = Configuration 1 = Single driver U = UVLO level G = 3 V A = 5 V B = 8 V D = 12 V V = Isolation rating A = 1 kV _{RMS} B = 2.5 kV _{RMS}
Line 2 Marking: ¹	WX = Ordering options	W = Dead-time setting range none = not included 1 = 10-200 ns 4 = 20-700 ns X = Integrated deglitch circuit none = not included D = integrated
	YY = Year WW = Work week	Assigned by the Assembly House. Corresponds to the year and workweek of the mold date.
Line 3 Marking:	TTTTTT = Mfg code	Manufacturing Code from Assembly Purchase Order form. The Manufacturing Code represented by "TTTTTT" contains, as its first character, a letter in the range N through Z to indicate Automotive-Grade.
Note: 1. Characters W and/or X are optional and may be missing from the marking line. When missing, the remaining characters are right-justified on the marking line.		

8.3 Si827x Top Marking (14-Pin DFN)



Table 8.3. Top Marking Explanation (14-Pin DFN)

Line 1 Marking:	Base Part Number Ordering Options See 1. Ordering Guide for more information.	Si827 = ISOdriver product series Y = configuration 3 = High-side/Low-side (HS/LS) 4 = PWM HS/LS 5 = Dual driver
Line 2 Marking: ¹	Ordering Options	U = UVLO level G = 3 V A = 5 V B = 8 V D = 12 V V = Isolation rating A = 1 kV _{RMS} B = 2.5 kV _{RMS} W = Dead-time setting range none = not included 1 = 10-200 ns 4 = 20-700 ns X = Integrated deglitch circuit none = not included D = integrated
Line 3 Marking:	TTTTTT = Mfg code	Manufacturing Code from Assembly Purchase Order form. The Manufacturing Code represented by “TTTTTT” contains, as its first character, a letter in the range N through Z to indicate Automotive-Grade.
Line 4 Marking:	Circle = 1.5 mm diameter YYWW	Pin 1 identifier. Manufacturing date code.
Note: 1. Characters W and/or X are optional and may be missing from the marking line. When missing, the remaining characters are right-justified on the marking line.		

9. Revision History

Revision A

July, 2022

- Added Agile data sheet revision in footer.

Revision 1.06

April, 2021

- Added automotive-grade ordering part numbers to [1. Ordering Guide](#).

Revision 1.05

September, 2020

- Added Si8271GB-AS to [1. Ordering Guide](#).

Revision 1.04

May, 2020

- Adjusted industrial ordering guide to group by isolation rating.
- Added 8 new OPNs rated at 1 kV_{RMS} to the [Table 1.1 on page 2](#).
- Added Si8273GB-IM1 to [Table 1.1 on page 2](#).
- Added footnotes section to [Table 1.1 on page 2](#) and appropriate footnotes.
- Removed duplicate Si8273BB-IS1 line in the [Table 1.1 on page 2](#).
- The QFN package was renamed to DFN throughout the document and pin count naming was unified with SOIC packages.
- Updated and unified style and naming conventions throughout the document.
- Edited CQC basic working voltage rating from 600 V to 250 V and removed the reinforced working voltage rating in [Table 4.2 on page 25](#).
- Edited [Table 4.8 on page 30](#) and clarified negative transient tolerance specification.
- Edited the Top Marking Explanation tables in [8. Top Markings](#) and added a footnote clarifying how optional characters are represented.
- Removed "component notice 5A" from CSA certification descriptions in [Table 4.2 on page 25](#).
- Added "-2011" to CQC certification descriptions in [Table 4.2 on page 25](#).
- Corrected Dead-Time Adjustable Range on Si8274DB1-AS1 to 10-100 ns in [Table 1.1 on page 2](#).
- Updated diagrams in [2. System Overview](#) to improve readability.
- Updated application diagrams in [3. Applications](#) to improve readability and to follow updated naming conventions.
- Corrected IC Junction-to-Air Thermal Resistance (θ_{JA}) specifications for all packages in [Table 4.7 on page 28](#).
- Clarified [Figure 4.1 on page 24](#), [Figure 4.2 on page 24](#), and [Figure 4.3 on page 25](#).
- Updated thermal derating curves, power dissipation example, and safety input current specifications and test conditions for all packages based on new θ_{JA} specifications.
- Added a new thermal derating curve for the DFN-14 package ([Figure 4.6 on page 29](#)) based on the new θ_{JA} specification.
- Clarified, reorganized, and updated the [2.4 Power Dissipation Considerations](#) section.
- [Figure 6.3 on page 38](#) and [Table 6.3 on page 38](#) were edited and clarified.
- Footnote 3 was removed from [Table 6.3 on page 38](#).
- Removed the single driver option from Line 1 Marking row in [Table 8.3 on page 44](#)
- Reorganized and clarified [2.7 Overlap Protection and Programmable Dead Time](#)
- Clarified conditions for typical specifications in [Table 4.1 Electrical Characteristics on page 21](#)

Revision 1.03

October, 2019

- Added Si8275BB-AS1 and Si8275GB-AS1 to [Ordering Guide for Automotive Grade OPNs](#).

Revision 1.02

June, 2019

- Updated [Table 1.1 Si827x Ordering Guide^{1, 2, 3} on page 2](#).

Revision 1.01

April, 2019

- Added Si8271AB-AS and Si8274BB4D-AS1 to [Ordering Guide for Automotive Grade OPNs](#).

Revision 1.0

May, 2018

- Replaced references and descriptions of LGA package with QFN package throughout the data sheet.
- Updated OPNs with LGA package denoted by -IM suffix to QFN packages denoted by -IM1 suffix in the [Ordering Guide](#).
- Added Si8274DB1-AS1 OPN to [Ordering Guide for Automotive Grade OPNs](#).
- Added Note 6 to [Ordering Guide for Automotive Grade OPNs](#) referring to Top Markings for Automotive Grade parts.
- Updated Equation 3 and the chart generated by Equation 3 in [Figure 2.17 Max Load vs. Switching Frequency](#) on page 15.
- Corrected power dissipation example calculations in [Power Dissipation Considerations](#).
- Updated [Package Outline: 14 LD QFN](#) with new QFN package outline drawing and updated [Table 6.3 Package Diagram Dimensions](#) on page 38 with QFN package dimensions.
- Updated [Table 4.2 Regulatory Information](#) on page 25 with certification information.
- Updated [Table 4.3 Insulation and Safety-Related Specifications](#) on page 26 symbols and clarified parameters.
- Added Surge Voltage specification to [Table 4.5 VDE 0884 Insulation Characteristics](#) on page 27.
- Updated description of [Figure 4.5 NB SOIC-16, QFN-14 Thermal Derating Curve](#) on page 28 and [Figure 4.4 NB SOIC-8 Thermal Derating Curve](#) on page 28.

Revision 0.6

December, 2017

- Updated [Figure 2.12 Rise/Fall Time vs. Load](#) on page 10.
- Updated [Table 4.1 Electrical Characteristics](#) on page 21.
 - Added "(no load)" under IDDx specification test condition.
 - Added t_{SD} and $t_{RESTART}$ specs.
- Corrected storage temp and power dissipation for SOIC-8 package in [Table 4.6 IEC Safety Limiting Values¹](#) on page 27.
- Added footnote about VO+ and VOA/VOB voltages with respect to ground in [Table 4.8 Absolute Maximum Ratings¹](#) on page 30 with improvement from other pins.
- Added new table to Ordering Guide for Automotive-Grade OPN options.

Revision 0.5

February, 2016

- Initial release.



**Connecting Everyone
and Everything,
All the Time**



Portfolio

skyworksinc.com



Quality

skyworksinc.com/quality



Support & Resources

skyworksinc.com/support

Copyright © 2022 Skyworks Solutions, Inc. All Rights Reserved.

Information in this document is provided in connection with Skyworks Solutions, Inc. ("Skyworks") products or services. These materials, including the information contained herein, are provided by Skyworks as a service to its customers and may be used for informational purposes only by the customer. Skyworks assumes no responsibility for errors or omissions in these materials or the information contained herein. Skyworks may change its documentation, products, services, specifications or product descriptions at any time, without notice. Skyworks makes no commitment to update the materials or information and shall have no responsibility whatsoever for conflicts, incompatibilities, or other difficulties arising from any future changes.

No license, whether express, implied, by estoppel or otherwise, is granted to any intellectual property rights by this document. Skyworks assumes no liability for any materials, products or information provided hereunder, including the sale, distribution, reproduction or use of Skyworks products, information or materials, except as may be provided in Skyworks' Terms and Conditions of Sale.

THE MATERIALS, PRODUCTS AND INFORMATION ARE PROVIDED "AS IS" WITHOUT WARRANTY OF ANY KIND, WHETHER EXPRESS, IMPLIED, STATUTORY, OR OTHERWISE, INCLUDING FITNESS FOR A PARTICULAR PURPOSE OR USE, MERCHANTABILITY, PERFORMANCE, QUALITY OR NON-INFRINGEMENT OF ANY INTELLECTUAL PROPERTY RIGHT; ALL SUCH WARRANTIES ARE HEREBY EXPRESSLY DISCLAIMED. SKYWOKS DOES NOT WARRANT THE ACCURACY OR COMPLETENESS OF THE INFORMATION, TEXT, GRAPHICS OR OTHER ITEMS CONTAINED WITHIN THESE MATERIALS. SKYWOKS SHALL NOT BE LIABLE FOR ANY DAMAGES, INCLUDING BUT NOT LIMITED TO ANY SPECIAL, INDIRECT, INCIDENTAL, STATUTORY, OR CONSEQUENTIAL DAMAGES, INCLUDING WITHOUT LIMITATION, LOST REVENUES OR LOST PROFITS THAT MAY RESULT FROM THE USE OF THE MATERIALS OR INFORMATION, WHETHER OR NOT THE RECIPIENT OF MATERIALS HAS BEEN ADVISED OF THE POSSIBILITY OF SUCH DAMAGE.

Skyworks products are not intended for use in medical, lifesaving or life-sustaining applications, or other equipment in which the failure of the Skyworks products could lead to personal injury, death, physical or environmental damage. Skyworks customers using or selling Skyworks products for use in such applications do so at their own risk and agree to fully indemnify Skyworks for any damages resulting from such improper use or sale.

Customers are responsible for their products and applications using Skyworks products, which may deviate from published specifications as a result of design defects, errors, or operation of products outside of published parameters or design specifications. Customers should include design and operating safeguards to minimize these and other risks. Skyworks assumes no liability for applications assistance, customer product design, or damage to any equipment resulting from the use of Skyworks products outside of Skyworks' published specifications or parameters.



Skyworks, the Skyworks symbol, Sky5[®], SkyOne[®], SkyBlue[™], Skyworks Green[™], ClockBuilder[®], DSPLL[®], ISOmodem[®], ProSLIC[®], and SiPHY[®] are trademarks or registered trademarks of Skyworks Solutions, Inc. or its subsidiaries in the United States and other countries. Third-party brands and names are for identification purposes only and are the property of their respective owners. Additional information, including relevant terms and conditions, posted at www.skyworksinc.com, are incorporated by reference.

Skyworks Solutions, Inc. | Nasdaq: SWKS | sales@skyworksinc.com | www.skyworksinc.com

USA: 781-376-3000 | Asia: 886-2-2735 0399 | Europe: 33 (0)1 43548540

Looking for pricing, stock, or lifecycle information?

Click below to explore more details on WIN SOURCE:

-  [View S18275BB-IS1 on WIN SOURCE](#)
-  [Skyworks Solutions Inc. Information](#)

Optimize Your Supply Chain with WIN SOURCE Solutions

-  Global Sourcing Solution
-  Obsolete Management
-  Cost Control Management
-  Shortage Management
-  Alternative Solution
-  Excess Inventory Management