

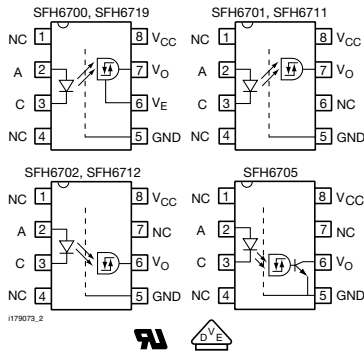

**THE DATASHEET OF
SFH6702-X006**

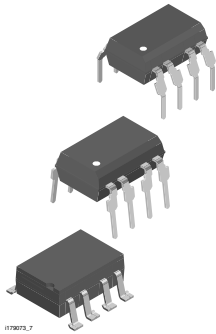

High Speed Optocoupler, 5 MBd, 1 kV/ μ s dV/dt



DESCRIPTION

The SFH67xx high speed optocoupler series consists of a GaAlAs infrared emitting diode, optically coupled with an integrated photo detector. The detector incorporates a Schmitt-Trigger stage for improved noise immunity. Using the enable input, the output can be switched to the high ohmic state, which is necessary for data bus applications. A Faraday shield provides a common mode transient immunity of 1000 V/ μ at $V_{CM} = 50$ V for SFH6700, SFH6701, SFH6702, SFH6705 and 2500 V/ μ at $V_{CM} = 400$ V for SFH6711, SFH6712, SFH6719.

The SFH67xx uses an industry standard DIP-8 package. With standard lead bending, creepage distance and clearance of ≥ 7 mm with lead bending options 6, 7, and 9 ≥ 8 mm are achieved.

FEATURES

- Data rate 5 MBit/s (2.5 MBit/s over temperature)
- Buffer
- Isolation test voltage, 5300 V_{RMS} for 1 s
- TTL, LSTTL and CMOS compatible
- Internal shield for very high common mode transient immunity
- Wide supply voltage range (4.5 V to 15 V)
- Low input current (1.6 mA to 5 mA)
- Three state output (SFH6700, SFH6719)
- Totem pole output (SFH6701, SFH6702, SFH6711, SFH6712)
- Open collector output (SFH6705)
- Compliant to RoHS Directive to 2002/95/EC and in accordance WEEE 2002/96/EC



RoHS
COMPLIANT

APPLICATIONS

- Industrial control
- Replace pulse transformers
- Routine logic interfacing
- Motion/power control
- High speed line receiver
- Microprocessor system interfaces
- Computer peripheral interfaces

AGENCY APPROVALS

- UL1577, file no. E52744 system code H or J, double protection
- DIN EN 60747-5-5 (VDE 0884) available with option 1

ORDERING INFORMATION

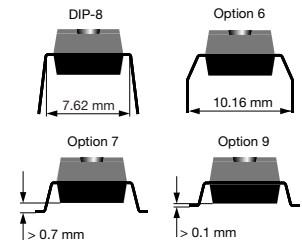
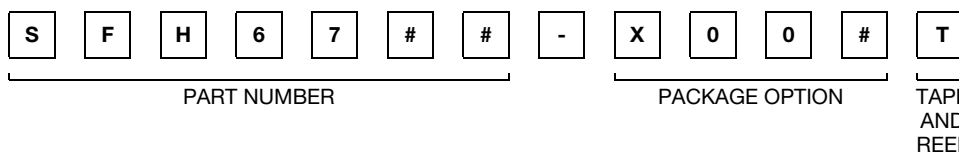

AGENCY CERTIFIED/ PACKAGE	THREE STATE	TOTEM POLE	OPEN COLLECTOR
UL			
DIP-8	SFH6700 SFH6719	SFH6701 SFH6702	SFH6711 SFH6712 -
DIP-8, 400 mil, option 6	-	SFH6702-X006	SFH6705-X006
SMD-8, option 7	-	SFH6701-X007 SFH6702-X007	SFH6711-X007 SFH6712-X007 -
SMD-8, option 9	SFH6700-X009	SFH6702-X009T ⁽¹⁾	SFH6701-X009T ⁽¹⁾ -

Note

- Also available in tubes. To order, do not add T on end



TRUTH TABLE (positive logic)			
PARTS	IR DIODE	ENABLE	OUTPUT
SFH6700	on	H	Z
	off	H	Z
SFH6719	on	L	H
	off	L	L
SFH6701	on		H
	off		L
SFH6702	on		H
	off		L
SFH6705	on		H
	off		L
SFH6711	on		H
	off		L
SFH6712	on		H
	off		L

ABSOLUTE MAXIMUM RATINGS ($T_{amb} = 25\text{ }^{\circ}\text{C}$, unless otherwise specified)				
PARAMETER	TEST CONDITION	SYMBOL	VALUE	UNIT
INPUT				
Reverse voltage		V_R	3	V
DC forward current		I_F	10	mA
Surge forward current	$t \leq 1\ \mu\text{s}$	I_{FSM}	1	A
Power dissipation		P_{diss}	20	mW
OUTPUT				
Supply voltage		V_{CC}	- 0.5 to + 15	V
Three state enable voltage (SFH6700, SFH6719 only)		V_{EN}	- 0.5 to + 15	V
Output voltage		V_O	- 0.5 to + 15	V
Average output current		I_O	25	mA
Power dissipation		P_{diss}	100	mW
COUPLER				
Storage temperature range		T_{stg}	- 55 to + 125	$^{\circ}\text{C}$
Ambient temperature range		T_{amb}	+ 85	$^{\circ}\text{C}$
Lead soldering temperature	$t = 10\ \text{s}$	T_{sld}	260	$^{\circ}\text{C}$
Isolation test voltage		V_{ISO}	5300	V_{RMS}
Pollution degree			2	
Creepage distance and clearance	Standard lead bending		7	mm
	Options 6, 7, 9		8	mm
Comparative tracking index per DIN IEC 112/VDE 0303, part 1			175	
Isolation resistance	$V_{IO} = 500\ \text{V}, T_{amb} = 25\text{ }^{\circ}\text{C}$	R_{IO}	10^{12}	Ω
	$V_{IO} = 500\ \text{V}, T_{amb} = 100\text{ }^{\circ}\text{C}$	R_{IO}	10^{11}	Ω

Note

- Stresses in excess of the absolute maximum ratings can cause permanent damage to the device. Functional operation of the device is not implied at these or any other conditions in excess of those given in the operational sections of this document. Exposure to absolute maximum ratings for extended periods of the time can adversely affect reliability.



SFH6700, SFH6701, SFH6702, SFH6705, SFH6711, SFH6712, SFH6719

High Speed Optocoupler, 5 MBd,
1 kV/ μ s dV/dt

Vishay Semiconductors

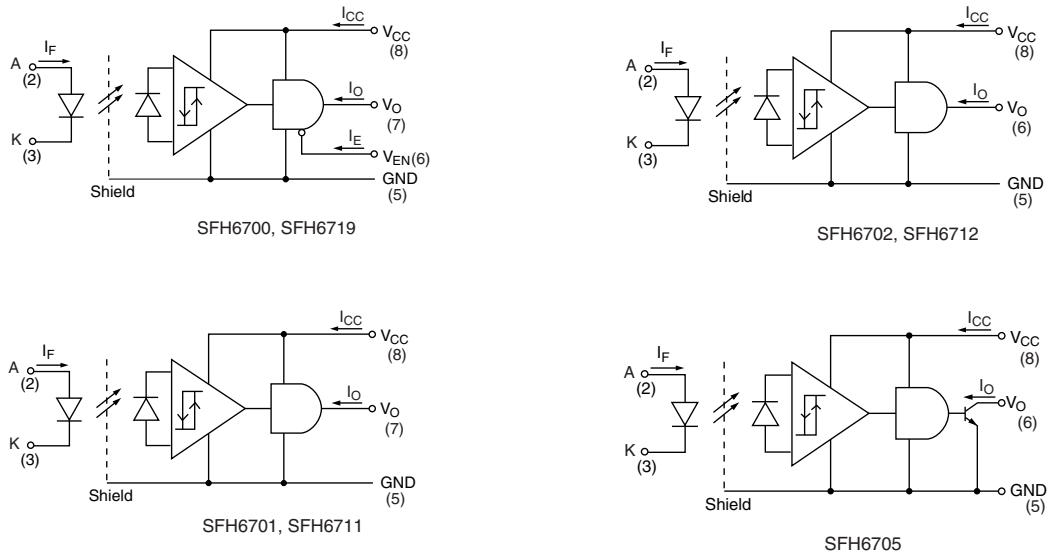

Fig. 1 - Schematics

isfh6700_01

RECOMMENDED OPERATING CONDITIONS ⁽¹⁾							
PARAMETER	TEST CONDITION	PART	SYMBOL	MIN.	TYP.	MAX.	UNIT
Supply voltage			V_{CC}	4.5		15	V
Enable voltage high		SFH6700	V_{EH}	2		15	V
		SFH6719	V_{EH}	2		15	V
Enable voltage low		SFH6700	V_{EL}	0		0.8	V
		SFH6719	V_{EL}	0		0.8	V
Forward input current			I_{Fon}	1.6 ⁽²⁾		5	mA
			I_{Foff}			0.1	mA
Operating temperature			T_{amb}	- 40		85	$^{\circ}$ C
Output pull-up resistor		SFH6705	R_L	350		4	k Ω
Fan output	$R_L = 1\text{ k}\Omega$	SFH6705	N			16	LS TTL loads

Notes

- (1) A 0.1 μ F bypass capacitor connected between pins 5 and 8 must be used.
 (2) We recommended using a 2.2 mA to permit at least 20 % CTR degradation guard band.

ELECTRICAL CHARACTERISTICS ⁽¹⁾							
PARAMETER	TEST CONDITION	SYMBOL	MIN.	TYP.	MAX.	UNIT	
INPUT							
Forward voltage	$I_F = 5\text{ mA}$	V_F		1.6	1.75	V	
	$I_F = 5\text{ mA}$	V_F			1.8	V	
Input current hysteresis	$V_{CC} = 5\text{ V}, I_{HYS} = I_{Fon} - I_{Foff}$	I_{HYS}		0.1		mA	
Reverse current	$V_R = 3\text{ V}$	I_R		0.5	10	μ A	
Capacitance	$V_R = 0\text{ V}, f = 1\text{ MHz}$	C_O		60		pF	
Thermal resistance		R_{thJA}		700		K/W	
OUTPUT							
Logic low output voltage	$I_{OL} = 6.4\text{ mA}$	V_{OL}			0.5	V	
Logic high output voltage (except SFH6705)	$I_{OH} = 2.6\text{ mA}, V_{OH} = V_{CC} - 1.8\text{ V}$		2.4			V	
Output leakage current ($V_{OUT} > V_{CC}$) (except SFH6705)	$V_O = 5.5\text{ V}, V_{CC} = 4.5\text{ V}, I_F = 5\text{ mA}$	I_{OHH}		0.5	100	μ A	
	$V_O = 15\text{ V}, V_{CC} = 4.5\text{ V}, I_F = 5\text{ mA}$	I_{OHH}		1	500	μ A	



ELECTRICAL CHARACTERISTICS (1)						
PARAMETER	TEST CONDITION	SYMBOL	MIN.	TYP.	MAX.	UNIT
OUTPUT						
Output leakage current (SFH6705 only)	$V_O = 5.5\text{ V}, V_{CC} = 5.5\text{ V}, I_F = 5\text{ mA}$	I_{OHH}		0.5	100	μA
	$V_O = 15\text{ V}, V_{CC} = 15\text{ V}, I_F = 5\text{ mA}$	I_{OHH}		1	500	μA
Logic high enable voltage (SFH6700/19 only)		V_{EH}	2			V
Logic low enable voltage (SFH6700/19 only)		V_{EL}			0.8	V
Logic high enable current (SFH6700/19 only)	$V_{EN} = 2.7\text{ V}$	I_{EH}			20	μA
	$V_{EN} = 5.5\text{ V}$	I_{EH}			100	μA
	$V_{EN} = 15\text{ V}$	I_{EH}		0.001	250	μA
Logic low enable current (SFH6700/19 only)	$V_{EN} = 0.4\text{ V}$	I_{EL}	- 320	- 50		μA
High impedance state output current (SFH6700/19 only)	$V_O = 0.4\text{ V}, V_{EN} = 2\text{ V}, I_F = 5\text{ mA}$	I_{OZL}	- 20			μA
	$V_O = 2.4\text{ V}, V_{EN} = 2\text{ V}, I_F = 0\text{ mA}$	I_{OZH}			20	μA
	$V_O = 5.5\text{ V}, V_{EN} = 2\text{ V}, I_F = 0\text{ mA}$	I_{OZH}		0.001	500	μA
Logic low supply current	$V_{CC} = 5.5\text{ V}, I_F = 0$	I_{CCL}		3.7	6	mA
	$V_{CC} = 15\text{ V}, I_F = 0$	I_{CCL}		4.1	6.5	mA
Logic high supply current	$V_{CC} = 5.5\text{ V}, I_F = 5\text{ mA}$	I_{CCH}		3.4	4	mA
	$V_{CC} = 15\text{ V}, I_F = 5\text{ mA}$	I_{CCH}		3.7	5	mA
Logic low short circuit output current (2)	$V_O = V_{CC} = 5.5\text{ V}, I_F = 0$	I_{OSL}	25			mA
	$V_O = V_{CC} = 15\text{ V}, I_F = 0$	I_{OSL}	40			mA
Logic high short circuit output current (2)	$V_{CC} = 5.5\text{ V}, V_O = 0\text{ V}, I_F = 5$	I_{OSL}			- 10	mA
	$V_{CC} = 15\text{ V}, V_O = 0\text{ V}, I_F = 5$	I_{OSL}			- 25	mA
Thermal resistance		R_{thJA}		300		K/W
COUPLER						
Capacitance (input to output)	$f = 1\text{ MHz}$, pins 1 to 4 and 5 to 8 shorted together	C_{IO}		0.6		pF
Isolation resistance	$V_{IO} = 500\text{ V}, T_{amb} = 25\text{ }^\circ\text{C}$	R_{IO}	10^{12}			Ω
	$V_{IO} = 500\text{ V}, T_{amb} = 100\text{ }^\circ\text{C}$	R_{IO}	10^{11}			Ω

Notes

(1) - 40 °C \leq T_{amb} \leq 85 °C; 4.5 V \leq V_{CC} \leq 15 V; 1.6 mA \leq I_{Fon} \leq 5 mA; 2 \leq V_{EH} \leq 15 V; 0 \leq V_{EL} \leq 0.8 V; 0 mA \leq I_{Foff} \leq 0.1 mA. Typical values: T_{amb} = 25 °C; V_{CC} = 5 V; I_{Fon} = 3 mA unless otherwise specified. Minimum and maximum values are testing requirements. Typical values are characteristics of the device and are the result of engineering evaluation. Typical values are for information only and are not part of the testing requirements.

(2) Output short circuit time \leq 10 ms.

SWITCHING CHARACTERISTICS (1)							
PARAMETER	TEST CONDITION	PART	SYMBOL	MIN.	TYP.	MAX.	UNIT
Propagation delay time to logic low output level, SFH6700, SFH6701, SFH6702, SFH6711, SFH6712, SFH6719 (2)	Without peaking capacitor		t _{PHL}		120		ns
			t _{PHL}		115	300	ns
	With peaking capacitor		t _{PLH}		125		ns
			t _{PLH}		90	300	ns
Output enable time to logic high (SFH6700, SFH6719) (2)			t _{PZH}		20		ns
Output enable time to logic low (SFH6700, SFH6719) (2)			t _{PZL}		25		ns
Output disable time from logic low (SFH6700, SFH6719) (2)			t _{PLZ}		50		ns
Output rise time (2)	10 % to 90 %		t _r		40		ns
Output fall time (2)	90 % to 10 %		t _f		10		ns



SFH6700, SFH6701, SFH6702, SFH6705, SFH6711, SFH6712, SFH6719

High Speed Optocoupler, 5 MBd,
1 kV/ μ s dV/dt

Vishay Semiconductors

SWITCHING CHARACTERISTICS (1)							
PARAMETER	TEST CONDITION	PART	SYMBOL	MIN.	TYP.	MAX.	UNIT
Propagation delay time to logic low output level (3)	Without peaking capacitor	SFH6705	t_{PHL}		115		ns
	With peaking capacitor	SFH6705	t_{PHL}		105	300	ns
	Without peaking capacitor	SFH6705	t_{PLH}		125		ns
	With peaking capacitor	SFH6705	t_{PLH}		90	300	ns
Output rise time (3)	10 % to 90 %		t_r		25		ns
	90 % to 10 %		t_r		4		ns

Notes

- $0^\circ\text{C} \leq T_{amb} \leq 85^\circ\text{C}$; $4.5\text{ V} \leq V_{CC} \leq 15\text{ V}$; $1.6\text{ mA} \leq I_{Fon} \leq 5\text{ mA}$; $2 \leq V_{EH} \leq 15\text{ V}$ (SFH6700/19); $0 \leq V_{EL} \leq 0.8\text{ V}$ (SFH6700, SFH6719); $0\text{ mA} \leq I_{Foff} \leq 0.1\text{ mA}$
- Typical values: $T_{amb} = 25^\circ\text{C}$; $V_{CC} = 5\text{ V}$; $I_{Fon} = 3\text{ mA}$ unless otherwise specified (4)
- Typical values: $T_{amb} = 25^\circ\text{C}$; $V_{CC} = 5\text{ V}$; $I_{Fon} = 3\text{ mA}$; $R_L = 390\ \Omega$ unless otherwise specified (4)
- A $0.1\ \mu\text{F}$ bypass capacitor connected between pins 5 and 8 must be used

COMMON MODE TRANSIENT IMMUNITY (1)							
PARAMETER	TEST CONDITION	PART	SYMBOL	MIN.	TYP.	MAX.	UNIT
Logic high common mode transient immunity	$ V_{CM} = 50\text{ V}$, $I_F = 1.6\text{ mA}$	SFH6700	$ CM_H ^{(2)}$	1000			V/ μ s
		SFH6701	$ CM_H ^{(2)}$	1000			V/ μ s
		SFH6702	$ CM_H ^{(2)}$	1000			V/ μ s
		SFH6705	$ CM_H ^{(2)}$	1000			V/ μ s
	$ V_{CM} = 400\text{ V}$, $I_F = 1.6\text{ mA}$	SFH6711	$ CM_H ^{(2)}$	2500			V/ μ s
		SFH6712	$ CM_H ^{(2)}$	2500			V/ μ s
Logic Low common mode transient immunity	$ V_{CM} = 50\text{ V}$, $I_F = 0\text{ mA}$	SFH6700	$ CM_L ^{(3)}$	1000			V/ μ s
		SFH6701	$ CM_L ^{(3)}$	1000			V/ μ s
	$ V_{CM} = 50\text{ V}$, $I_F = 0\text{ mA}$	SFH6702	$ CM_L ^{(3)}$	1000			V/ μ s
		SFH6705	$ CM_L ^{(3)}$	1000			V/ μ s
	$ V_{CM} = 400\text{ V}$, $I_F = 0\text{ mA}$	SFH6711	$ CM_L ^{(3)}$	2500			V/ μ s
		SFH6712	$ CM_L ^{(3)}$	2500			V/ μ s
		SFH6719	$ CM_L ^{(3)}$	2500			V/ μ s

Notes

- $T_{amb} = 25^\circ\text{C}$, $V_{CC} = 5\text{ V}$
- CM_H is the maximum slew rate of a common mode voltage V_{CM} at which the output voltage remains at logic high level ($V_O > 2\text{ V}$)
- CM_L is the maximum slew rate of a common mode voltage V_{CM} at which the output voltage remains at logic low level ($V_O < 0.8\text{ V}$)

TYPICAL CHARACTERISTICS ($T_{amb} = 25^\circ\text{C}$, unless otherwise specified)

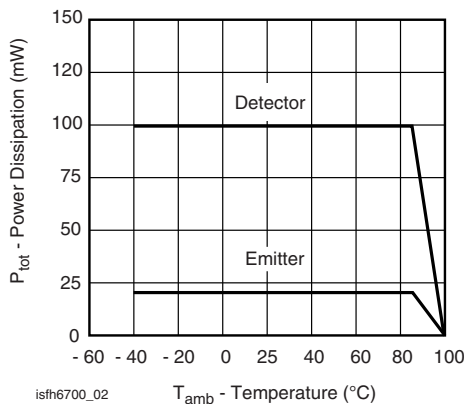

Fig. 2 - Permissible Total Power Dissipation vs. Temperature

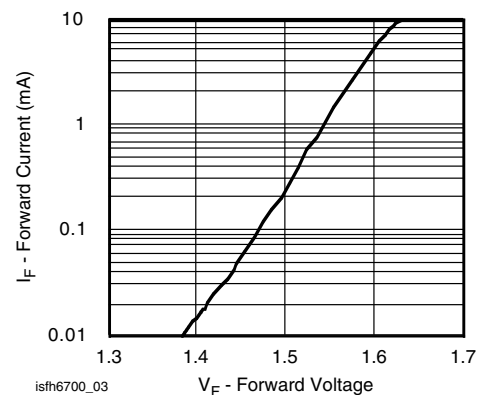

Fig. 3 - Typical Input Diode Forward Current vs. Forward Voltage

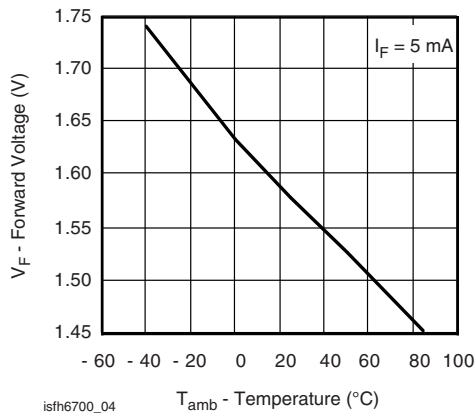

Fig. 4 - Typical Forward Input Voltage vs. Temperature

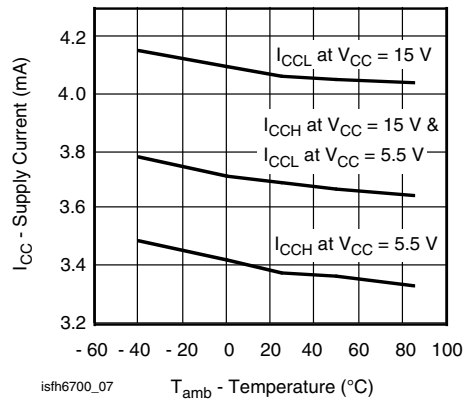

Fig. 7 - Typical Supply Current vs. Temperature

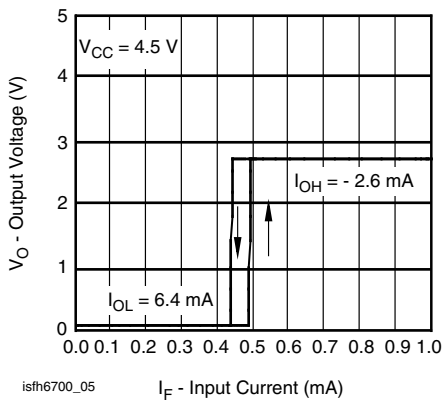

Fig. 5 - Typical Output Voltage vs. Forward Input Current (except SFH6705)

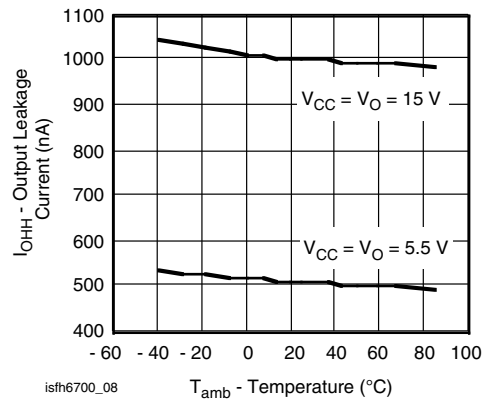

Fig. 8 - Typical Output Leakage Current vs. Temperature

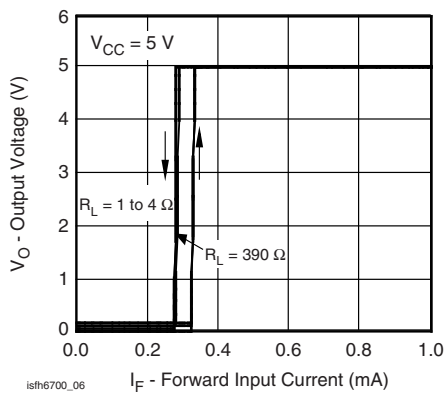

Fig. 6 - Typical Output Forward Voltage vs. Forward Input Current (only SFH6705)

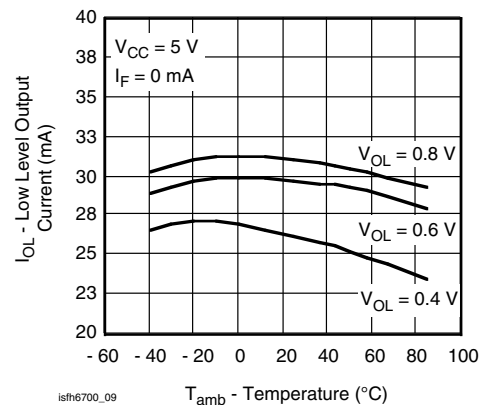

Fig. 9 - Typical Low Level Output Current vs. Temperature



SFH6700, SFH6701, SFH6702, SFH6705, SFH6711, SFH6712, SFH6719

High Speed Optocoupler, 5 MBd,
1 kV/ μ s dV/dt

Vishay Semiconductors

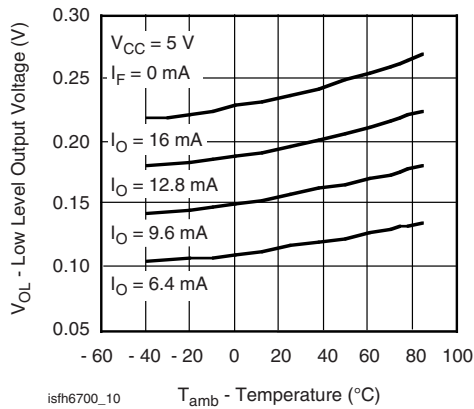

Fig. 10 - Typical Low Level Output Voltage vs. Temperature

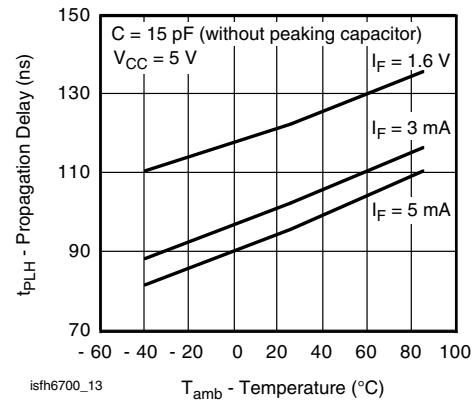

Fig. 13 - Typical Propagation Delay to Logic High vs. Temperature (except SFH6705)

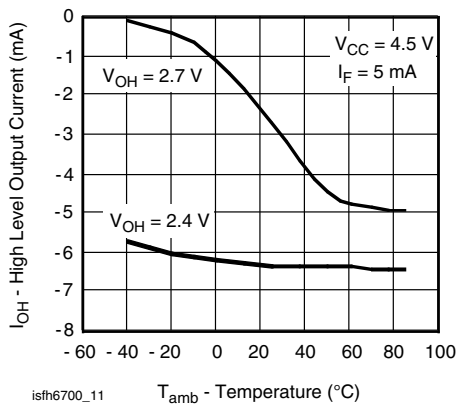

Fig. 11 - Typical High Level Output Current vs. Temperature (except SFH6705)

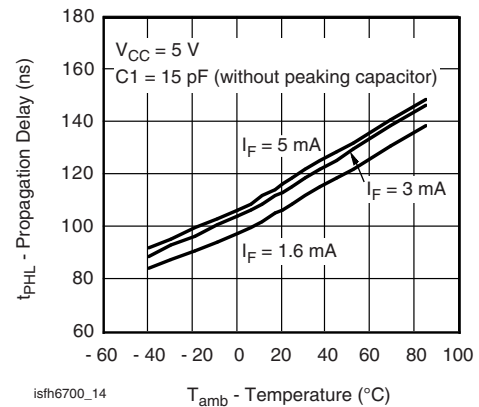

Fig. 14 - Typical Propagation Delay to Logic Low vs. Temperature (except SFH6705)

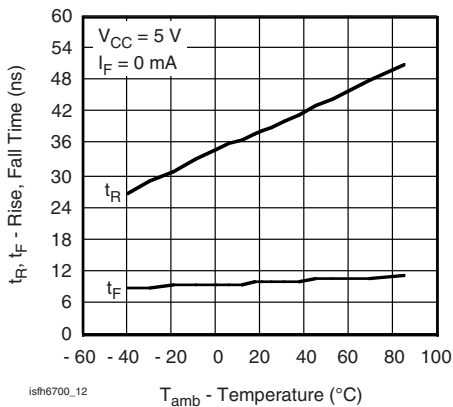

Fig. 12 - Typical Rise, Fall Time vs. Temperature (except SFH6705)

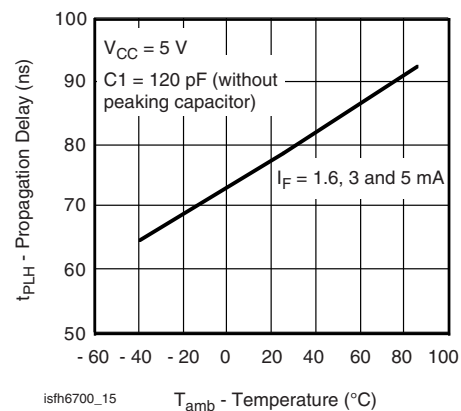

Fig. 15 - Typical Propagation Delays to Logic High vs. Temperature (except SFH6705)

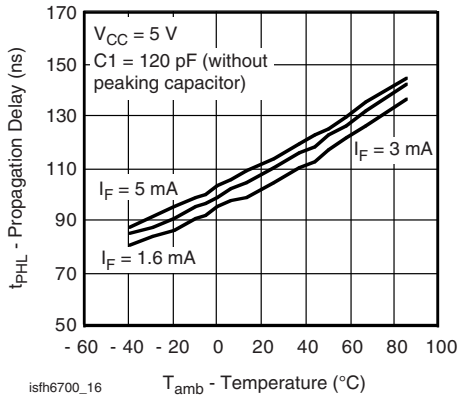

Fig. 16 - Typical Propagation Delay to Logic Low vs. Temperature

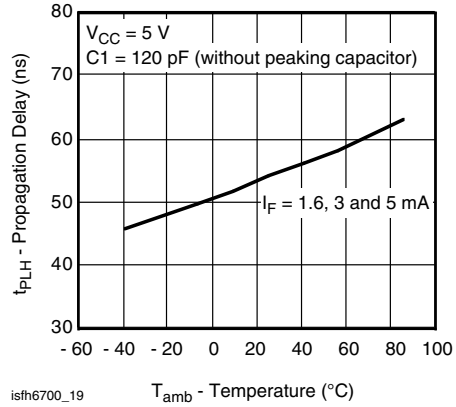

Fig. 19 - Typical Propagation Delays to Logic High vs. Temperature

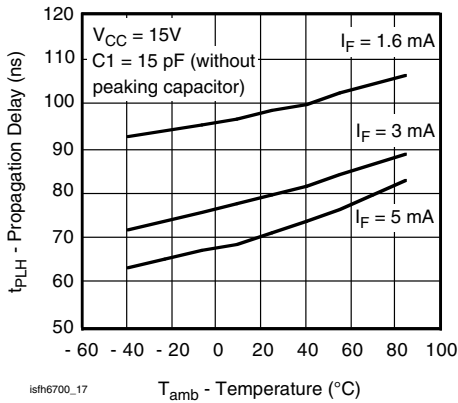

Fig. 17 - Typical Propagation Delays to Logic High vs. Temperature

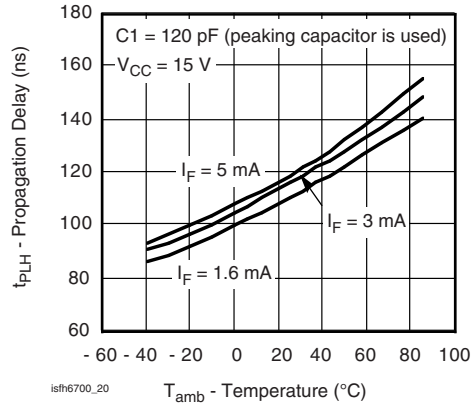

Fig. 20 - Typical Propagation Delays to Logic Low vs. Temperature (except SFH6705)

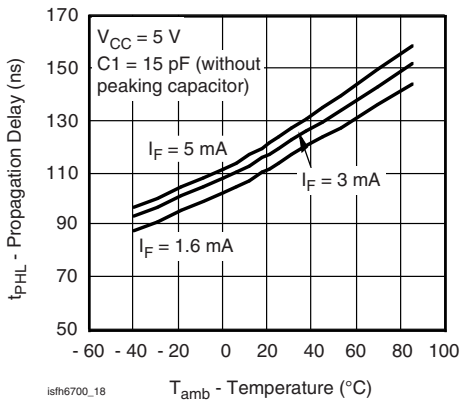

Fig. 18 - Typical Propagation Delays to Logic Low vs. Temperature

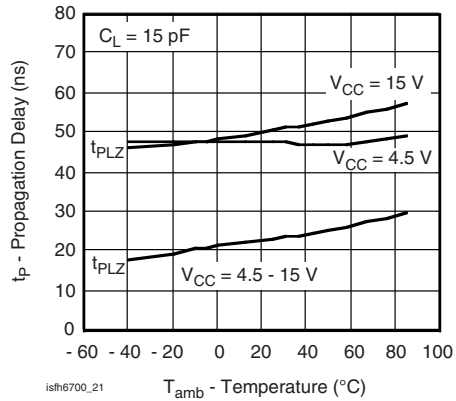

Fig. 21 - Typical Logic Low Enable Propagation Delays vs. Temperature (only SFH6700/11)



SFH6700, SFH6701, SFH6702, SFH6705, SFH6711, SFH6712, SFH6719

High Speed Optocoupler, 5 MBd, 1 kV/ μ s dV/dt Vishay Semiconductors

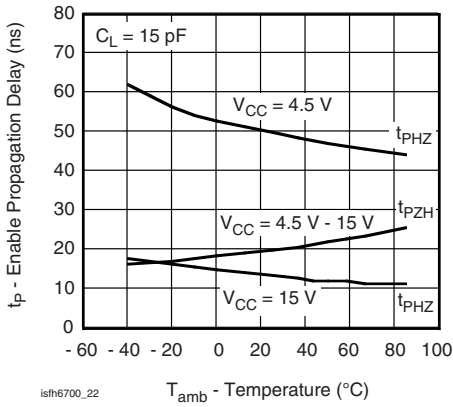

Fig. 22 - Typical Logic High Enable Propagation Delays vs. Temperature (only SFH6700/11)

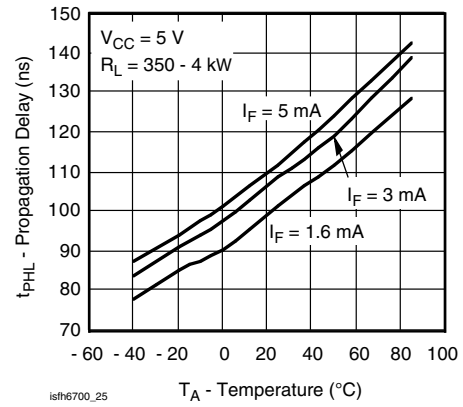

Fig. 25 - Typical Propagation Delays to Low Level vs. Temperature (only SFH6705)

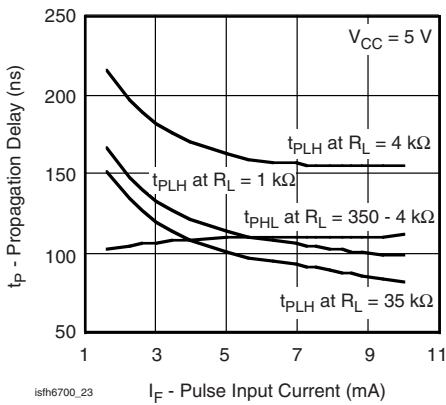

Fig. 23 - Typical Propagation Delays vs. Pulse Input Current (only SFH6705)

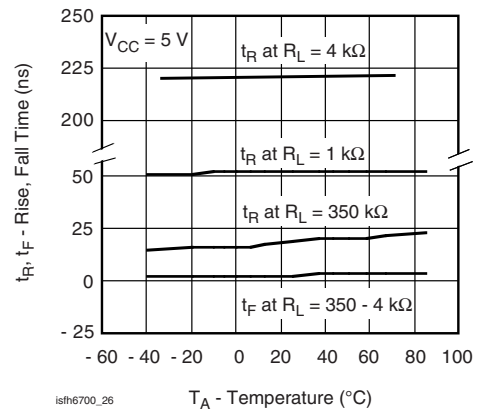

Fig. 26 - Typical Rise, Fall Time vs. Temperature (only SFH6705)

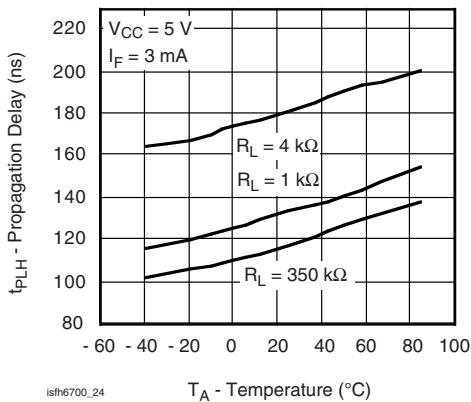
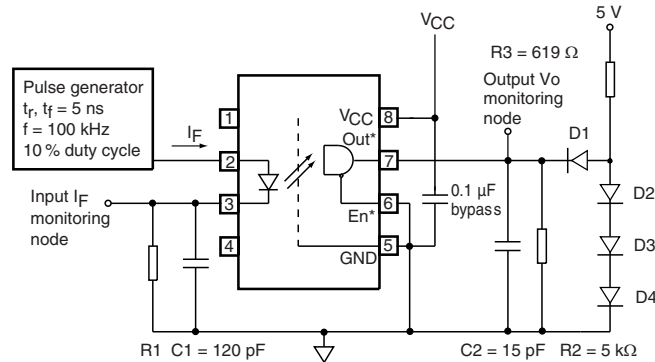

Fig. 24 - Typical Propagation Delays to High Level vs. Temperature (only SFH6705)

SFH6700, SFH6701, SFH6702, SFH6705, SFH6711, SFH6712, SFH6719



Vishay Semiconductors High Speed Optocoupler, 5 MBd,
1 kV/ μ s dV/dt



The probe and jig capacitances are included in C1 and C2 All diodes are 1N916 or 1N3064

R1	2.15 k Ω	1.1 k Ω	681 Ω
I _{Fon}	1.6 mA	3 mA	5 mA

* SFH6701, SFH6702, SFH6711, SFH6712 without V_{EN}
* SFH6702, SFH6712 pin 6 V_{OUT} and pin 7 NC

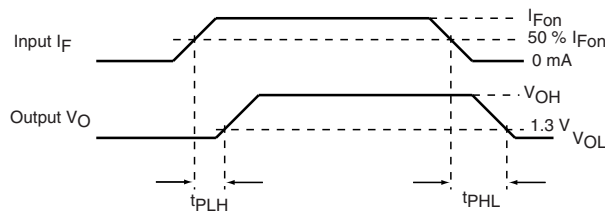

isfh6700_27

Fig. 27 - Test Circuit for t_{PLH} , t_{PHL} , t_r and t_f

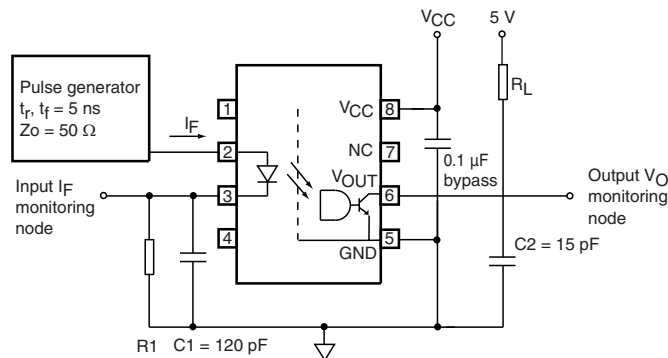

The probe and jig capacitances are included in C1 and C2

R1	2.15 k Ω	1.1 k Ω	681 Ω
I _{Fon}	1.6 mA	3 mA	5 mA

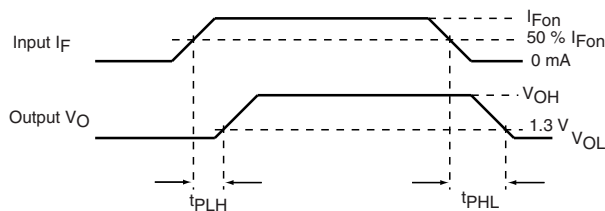

isfh6700_28

Fig. 28 - Test Circuit for t_{PLH} , t_{PHL} , t_r and - SFH6705

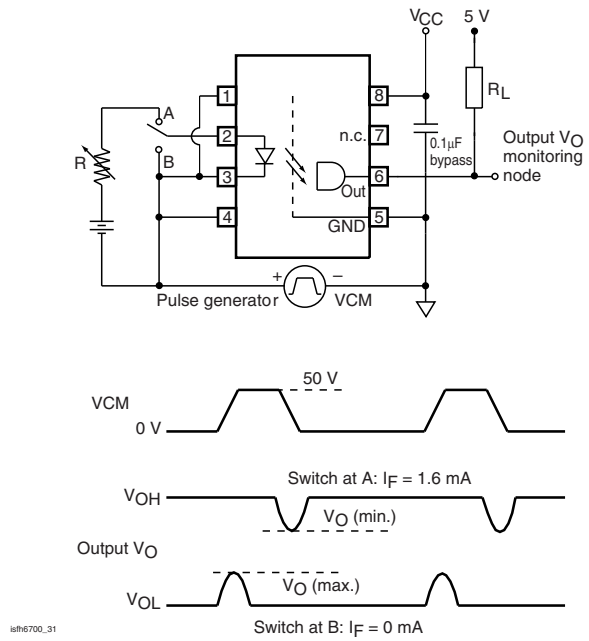

Fig. 31 - Test Circuit for Common Mode Transient Immunity and Typical Waveforms - SFH6705



SFH6700, SFH6701, SFH6702, SFH6705, SFH6711, SFH6712, SFH6719

High Speed Optocoupler, 5 MBd,
1 kV/ μ s dV/dt

Vishay Semiconductors

PACKAGE DIMENSIONS in millimeters

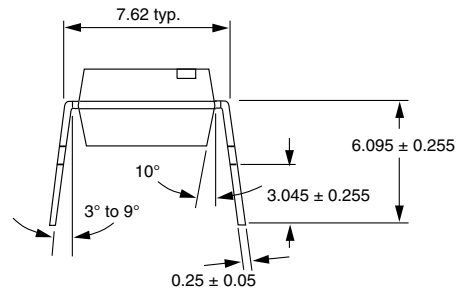
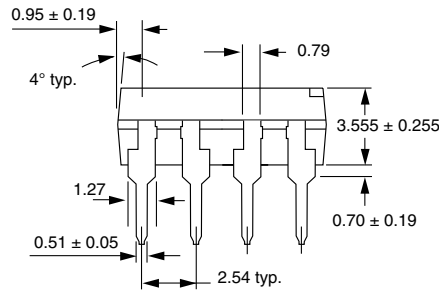
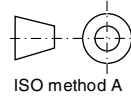
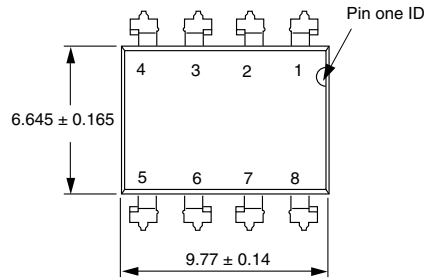

i178006

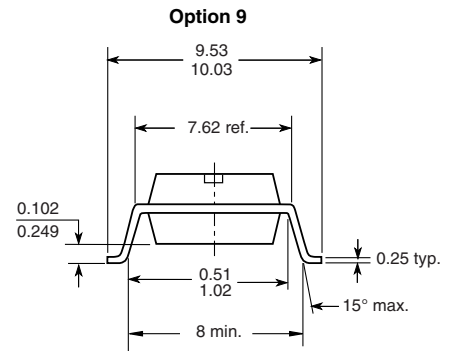
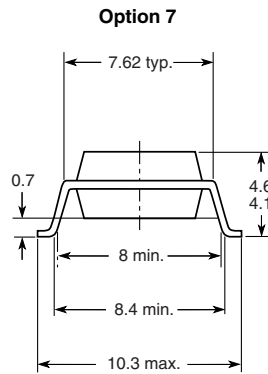
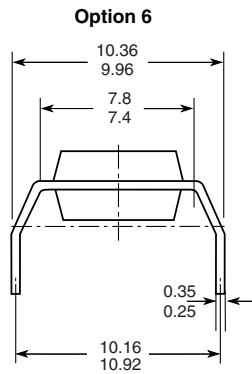

18450



Disclaimer

ALL PRODUCT, PRODUCT SPECIFICATIONS AND DATA ARE SUBJECT TO CHANGE WITHOUT NOTICE TO IMPROVE RELIABILITY, FUNCTION OR DESIGN OR OTHERWISE.

Vishay Intertechnology, Inc., its affiliates, agents, and employees, and all persons acting on its or their behalf (collectively, "Vishay"), disclaim any and all liability for any errors, inaccuracies or incompleteness contained in any datasheet or in any other disclosure relating to any product.

Vishay makes no warranty, representation or guarantee regarding the suitability of the products for any particular purpose or the continuing production of any product. To the maximum extent permitted by applicable law, Vishay disclaims (i) any and all liability arising out of the application or use of any product, (ii) any and all liability, including without limitation special, consequential or incidental damages, and (iii) any and all implied warranties, including warranties of fitness for particular purpose, non-infringement and merchantability.

Statements regarding the suitability of products for certain types of applications are based on Vishay's knowledge of typical requirements that are often placed on Vishay products in generic applications. Such statements are not binding statements about the suitability of products for a particular application. It is the customer's responsibility to validate that a particular product with the properties described in the product specification is suitable for use in a particular application. Parameters provided in datasheets and/or specifications may vary in different applications and performance may vary over time. All operating parameters, including typical parameters, must be validated for each customer application by the customer's technical experts. Product specifications do not expand or otherwise modify Vishay's terms and conditions of purchase, including but not limited to the warranty expressed therein.

Except as expressly indicated in writing, Vishay products are not designed for use in medical, life-saving, or life-sustaining applications or for any other application in which the failure of the Vishay product could result in personal injury or death. Customers using or selling Vishay products not expressly indicated for use in such applications do so at their own risk. Please contact authorized Vishay personnel to obtain written terms and conditions regarding products designed for such applications.

No license, express or implied, by estoppel or otherwise, to any intellectual property rights is granted by this document or by any conduct of Vishay. Product names and markings noted herein may be trademarks of their respective owners.

Material Category Policy

Vishay Intertechnology, Inc. hereby certifies that all its products that are identified as RoHS-Compliant fulfill the definitions and restrictions defined under Directive 2011/65/EU of The European Parliament and of the Council of June 8, 2011 on the restriction of the use of certain hazardous substances in electrical and electronic equipment (EEE) - recast, unless otherwise specified as non-compliant.

Please note that some Vishay documentation may still make reference to RoHS Directive 2002/95/EC. We confirm that all the products identified as being compliant to Directive 2002/95/EC conform to Directive 2011/65/EU.

Vishay Intertechnology, Inc. hereby certifies that all its products that are identified as Halogen-Free follow Halogen-Free requirements as per JEDEC JS709A standards. Please note that some Vishay documentation may still make reference to the IEC 61249-2-21 definition. We confirm that all the products identified as being compliant to IEC 61249-2-21 conform to JEDEC JS709A standards.

Looking for pricing, stock, or lifecycle information?

Click below to explore more details on WIN SOURCE:

 [View SFH6702-X006 on WIN SOURCE](#)

 [Vishay Information](#)

Optimize Your Supply Chain with WIN SOURCE Solutions

-  Global Sourcing Solution
-  Obsolete Management
-  Cost Control Management
-  Shortage Management
-  Alternative Solution
-  Excess Inventory Management