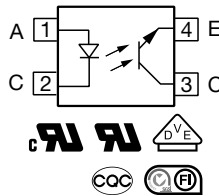
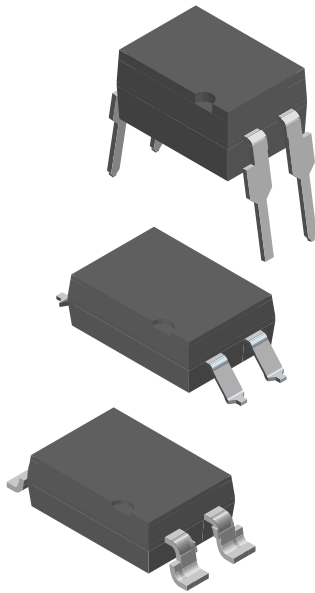




**THE DATASHEET OF  
SFH6106-4X001T**



# Optocoupler, Phototransistor Output, High Reliability, 5300 V<sub>RMS</sub>



## DESCRIPTION

The SFH610A and SFH6106 feature a high current transfer ratio, low coupling capacitance and high isolation voltage. These couplers have a GaAs infrared diode emitter, which is optically coupled to a silicon planar phototransistor detector, and is incorporated in a plastic DIP-4 or SMD package.

The coupling devices are designed for signal transmission between two electrically separated circuits.

The couplers are end-stackable with 2.54 mm spacing.

Creepage and clearance distances of > 8.0 mm are achieved with option 6 and option 8. This version complies with IEC 60950 (DIN VDE 0805) for reinforced insulation up to an operation voltage of 400 V<sub>RMS</sub> or DC. Specifications subject to change.

## FEATURES

- Good CTR linearity depending on forward current
- Isolation test voltage, 5300 V<sub>RMS</sub>
- High collector emitter voltage, V<sub>CEO</sub> = 70 V
- Low saturation voltage
- Fast switching times
- Low CTR degradation
- Temperature stable
- Low coupling capacitance
- End stackable, 0.100" (2.54 mm) spacing
- High common mode interference immunity
- Material categorization: for definitions of compliance please see [www.vishay.com/doc?99912](http://www.vishay.com/doc?99912)



**RoHS**  
COMPLIANT

## LINKS TO ADDITIONAL RESOURCES



## AGENCY APPROVALS

- [UL](#)
- [cUL](#)
- [DIN EN 60747-5-5 \(VDE 0804\)](#), available with option 1
- [BSI](#)
- [CQC](#)
- [FIMKO](#)



**ORDERING INFORMATION**

S	F	H	6	1	0	x	-	#	X	0	#	#	T
PART NUMBER								CTR BIN	PACKAGE OPTION			TAPE AND REEL	

AGENCY CERTIFIED / PACKAGE	CTR (%)				
	40 to 80	63 to 125	100 to 200	160 to 320	250 to 500
<b>UL, cUL, BSI, FIMKO, CQC</b>					
DIP-4	SFH610A-1	SFH610A-2	SFH610A-3	SFH610A-4	SFH610A-5
DIP-4, 400 mil, option 6	-	SFH610A-2X006	SFH610A-3X006	-	-
SMD-4	SFH6106-1T <sup>(1)</sup>	SFH6106-2T <sup>(1)</sup>	SFH6106-3T <sup>(1)</sup>	SFH6106-4T <sup>(1)</sup>	SFH6106-5T
SMD-4, option 7	-	-	SFH610A-3X007T	-	-
SMD-4, 400 mil, option 8	-	-	-	SFH610A-4X008T	-
<b>UL, cUL, BSI, FIMKO, CQC, VDE (option 1)</b>					
DIP-4	SFH610A-1X001	SFH610A-2X001	SFH610A-3X001	SFH610A-4X001	-
DIP-4, 400 mil, option 6	SFH610A-1X016	-	SFH610A-3X016	SFH610A-4X016	-
SMD-4	SFH6106-1X001T <sup>(1)</sup>	SFH6106-2X001T <sup>(1)</sup>	SFH6106-3X001T <sup>(1)</sup>	SFH6106-4X001T <sup>(1)</sup>	-
SMD-4, 400 mil, option 8	SFH610A-1X018T	-	-	-	-

**Notes**

- For additional information on the available options refer to option information
- <sup>(1)</sup> Also available in tubes; do not add T to end

ABSOLUTE MAXIMUM RATINGS (T <sub>amb</sub> = 25 °C, unless otherwise specified)				
PARAMETER	TEST CONDITION	SYMBOL	VALUE	UNIT
input				
Reverse voltage		V <sub>R</sub>	6	V
DC forward current		I <sub>F</sub>	60	mA
Surge forward current	t ≤ 10 μs	I <sub>FSM</sub>	2.5	A
Power dissipation		P <sub>diss</sub>	100	mW
output				
Collector emitter voltage		V <sub>CEO</sub>	70	V
Emitter collector voltage		V <sub>ECO</sub>	7	V
Collector current		I <sub>C</sub>	50	mA
	t <sub>p</sub> ≤ 1.0 ms	I <sub>C</sub>	100	mA
Power dissipation		P <sub>diss</sub>	150	mW
coupler				
Storage temperature range		T <sub>stg</sub>	-55 to +150	°C
Ambient temperature range		T <sub>amb</sub>	-55 to +100	°C
Soldering temperature <sup>(1)</sup>	Max. 10 s, dip soldering distance to seating plane ≥ 1.5 mm	T <sub>sld</sub>	260	°C

**Notes**

- Stresses in excess of the absolute maximum ratings can cause permanent damage to the device. Functional operation of the device is not implied at these or any other conditions in excess of those given in the operational sections of this document. Exposure to absolute maximum ratings for extended periods of the time can adversely affect reliability.
- <sup>(2)</sup> Refer to reflow profile for soldering conditions for surface mounted devices (SMD). Refer to wave profile for soldering conditions for through hole devices (DIP).



<b>ELECTRICAL CHARACTERISTICS</b> ( $T_{amb} = 25\text{ }^{\circ}\text{C}$ , unless otherwise specified)							
PARAMETER	TEST CONDITION	PART	SYMBOL	MIN.	TYP.	MAX.	UNIT
<b>INPUT</b>							
Forward voltage	$I_F = 60\text{ mA}$		$V_F$	-	1.25	1.65	V
Reverse current	$V_R = 6\text{ V}$		$I_R$	-	0.01	10	$\mu\text{A}$
Capacitance	$V_R = 0\text{ V}$ , $f = 1\text{ MHz}$		$C_O$	-	13	-	pF
Thermal resistance			$R_{thja}$	-	750	-	K/W
<b>OUTPUT</b>							
Collector emitter capacitance	$V_{CE} = 5\text{ V}$ , $f = 1\text{ MHz}$		$C_{CE}$	-	5.2	-	pF
Thermal resistance			$R_{thja}$	-	500	-	K/W
Collector emitter leakage current	$V_{CE} = 10\text{ V}$	SFH610A-1	$I_{CEO}$	-	2	50	nA
		SFH6106-1	$I_{CEO}$	-	2	50	nA
		SFH610A-2	$I_{CEO}$	-	2	50	nA
		SFH6106-2	$I_{CEO}$	-	2	50	nA
		SFH610A-3	$I_{CEO}$	-	5	100	nA
		SFH6106-3	$I_{CEO}$	-	5	100	nA
		SFH610A-4	$I_{CEO}$	-	5	100	nA
		SFH6106-4	$I_{CEO}$	-	5	100	nA
		SFH610A-5	$I_{CEO}$	-	5	100	nA
SFH6106-5	$I_{CEO}$	-	5	100	nA		
<b>COUPLER</b>							
Collector emitter saturation voltage	$I_F = 10\text{ mA}$ , $I_C = 2.5\text{ mA}$		$V_{CEsat}$	-	0.25	0.4	V
Coupling capacitance	$f = 1\text{ MHz}$		$C_C$	-	0.4	-	pF

**Note**

- Minimum and maximum values are testing requirements. Typical values are characteristics of the device and are the result of engineering evaluation. Typical values are for information only and are not part of the testing requirements.

<b>CURRENT TRANSFER RATIO</b>							
PARAMETER	TEST CONDITION	PART	SYMBOL	MIN.	TYP.	MAX.	UNIT
$I_C/I_F$	$I_F = 10\text{ mA}$ , $V_{CE} = 5.0\text{ V}$	SFH610A-1	CTR	40	-	80	%
		SFH6106-1	CTR	40	-	80	%
		SFH610A-2	CTR	63	-	125	%
		SFH6106-2	CTR	63	-	125	%
		SFH610A-3	CTR	100	-	200	%
		SFH6106-3	CTR	100	-	200	%
		SFH610A-4	CTR	160	-	320	%
		SFH6106-4	CTR	160	-	320	%
		SFH610A-5	CTR	250	-	500	%
	SFH6106-5T	CTR	250	-	500	%	
	$I_F = 1\text{ mA}$ , $V_{CE} = 5\text{ V}$	SFH610A-1	CTR	13	30	-	%
		SFH6106-1	CTR	13	30	-	%
		SFH610A-2	CTR	22	45	-	%
		SFH6106-2	CTR	22	45	-	%
		SFH610A-3	CTR	34	70	-	%
		SFH6106-3	CTR	34	70	-	%
		SFH610A-4	CTR	56	90	-	%
		SFH6106-4	CTR	56	90	-	%



SWITCHING CHARACTERISTICS							
PARAMETER	TEST CONDITION	PART	SYMBOL	MIN.	TYP.	MAX.	UNIT
<b>NON-SATURATED</b>							
Current	$V_{CC} = 5\text{ V}, R_L = 75\ \Omega$		$I_F$	-	10	-	mA
Rise time	$V_{CC} = 5\text{ V}, R_L = 75\ \Omega$		$t_r$	-	2	-	$\mu\text{s}$
Fall time	$V_{CC} = 5\text{ V}, R_L = 75\ \Omega$		$t_f$	-	2	-	$\mu\text{s}$
Turn-on time	$V_{CC} = 5\text{ V}, R_L = 75\ \Omega$		$t_{on}$	-	3	-	$\mu\text{s}$
Turn-off time	$V_{CC} = 5\text{ V}, R_L = 75\ \Omega$		$t_{off}$	-	2.3	-	$\mu\text{s}$
Cut-off frequency	$V_{CC} = 5\text{ V}$		$F_{CO}$	-	250	-	kHz
<b>SATURATED</b>							
Current		SFH610A-1	$I_F$	-	20	-	mA
		SFH6106-1					
		SFH610A-2	$I_F$	-	10	-	mA
		SFH6106-2					
		SFH610A-3	$I_F$	-	10	-	mA
		SFH6106-3					
SFH610A-4	$I_F$	-	5	-	mA		
SFH6106-4							
<b>SATURATED</b>							
Rise time		SFH610A-1	$t_r$	-	2	-	$\mu\text{s}$
		SFH6106-1					
		SFH610A-2	$t_r$	-	3	-	$\mu\text{s}$
		SFH6106-2					
		SFH610A-3	$t_r$	-	3	-	$\mu\text{s}$
		SFH6106-3					
SFH610A-4	$t_r$	-	4	-	$\mu\text{s}$		
SFH6106-4							
Fall time		SFH610A-1	$t_f$	-	11	-	$\mu\text{s}$
		SFH6106-1					
		SFH610A-2	$t_f$	-	14	-	$\mu\text{s}$
		SFH6106-2					
		SFH610A-3	$t_f$	-	14	-	$\mu\text{s}$
		SFH6106-3					
SFH610A-4	$t_f$	-	15	-	$\mu\text{s}$		
SFH6106-4							
Turn-on time		SFH610A-1	$t_{on}$	-	3	-	$\mu\text{s}$
		SFH6106-1					
		SFH610A-2	$t_{on}$	-	4.2	-	$\mu\text{s}$
		SFH6106-2					
		SFH610A-3	$t_{on}$	-	4.2	-	$\mu\text{s}$
		SFH6106-3					
SFH610A-4	$t_{on}$	-	6	-	$\mu\text{s}$		
SFH6106-4							
Turn-off time		SFH610A-1	$t_{off}$	-	18	-	$\mu\text{s}$
		SFH6106-1					
		SFH610A-2	$t_{off}$	-	23	-	$\mu\text{s}$
		SFH6106-2					
		SFH610A-3	$t_{off}$	-	23	-	$\mu\text{s}$
		SFH6106-3					
SFH610A-4	$t_{off}$	-	25	-	$\mu\text{s}$		
SFH6106-4							

**Note**

- All values presented are typical values

SAFETY AND INSULATION RATINGS				
PARAMETER	TEST CONDITION	SYMBOL	VALUE	UNIT
Climatic classification	According to IEC 68 part 1		55 / 100 / 21	
Comparative tracking index	Insulation group IIIa	CTI	175	
Maximum rated withstanding isolation voltage	According to UL1577, t = 1 min	$V_{ISO}$	4420	$V_{RMS}$
Tested withstanding isolation voltage	According to UL1577, t = 1 s	$V_{ISO}$	5300	$V_{RMS}$
Maximum transient isolation voltage	According to DIN EN 60747-5-5	$V_{IOTM}$	10 000	V
Maximum repetitive peak isolation voltage	According to DIN EN 60747-5-5	$V_{IORM}$	890	V
Isolation resistance	$V_{IO} = 500 \text{ V}, T_{amb} = 25 \text{ }^\circ\text{C}$	$R_{IO}$	$\geq 10^{12}$	$\Omega$
	$V_{IO} = 500 \text{ V}, T_{amb} = 100 \text{ }^\circ\text{C}$	$R_{IO}$	$\geq 10^{11}$	$\Omega$
Output safety power		$P_{SO}$	400	mW
Input safety current		$I_{SI}$	275	mA
Input safety temperature		$T_{SI}$	175	$^\circ\text{C}$
Creepage distance	DIP-4 / SMD-4		$\geq 7$	mm
Clearance distance			$\geq 7$	mm
Creepage distance	DIP-4, 400 mil / SMD-4, 400 mil		$\geq 8$	mm
Clearance distance			$\geq 8$	mm
Insulation thickness		DTI	$\geq 0.4$	mm

**Note**

- As per IEC 60747-5-5, § 7.4.3.8.2, this optocoupler is suitable for “safe electrical insulation” only within the safety ratings. Compliance with the safety ratings shall be ensured by means of protective circuits.

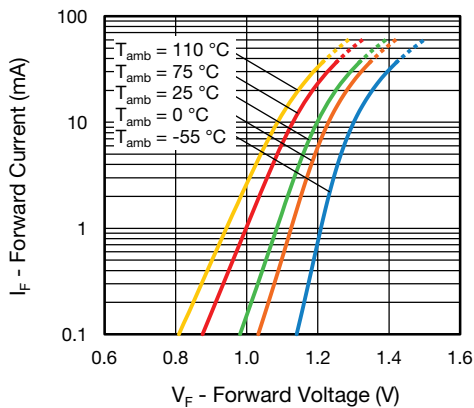
**TYPICAL CHARACTERISTICS** ( $T_{amb} = 25 \text{ }^\circ\text{C}$ , unless otherwise specified)


Fig. 1 - Forward Voltage vs. Forward Current

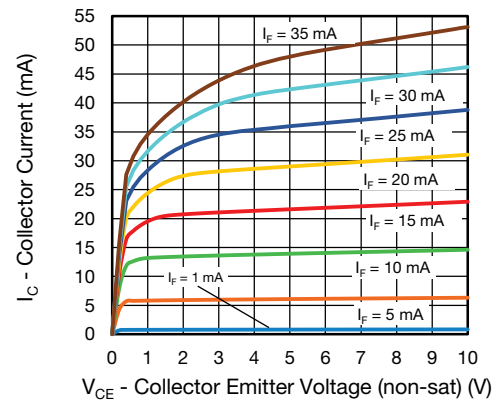


Fig. 2 - Collector Current vs. Collector Emitter Voltage (NS)

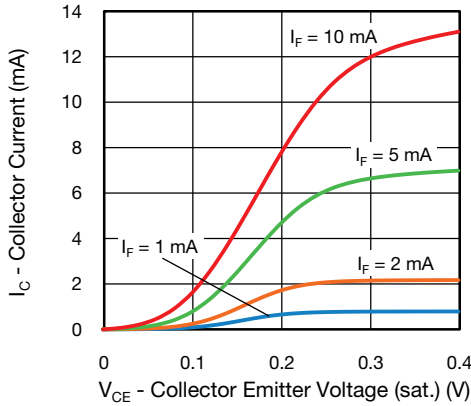


Fig. 3 - Collector Current vs. Collector Emitter Voltage (saturated)

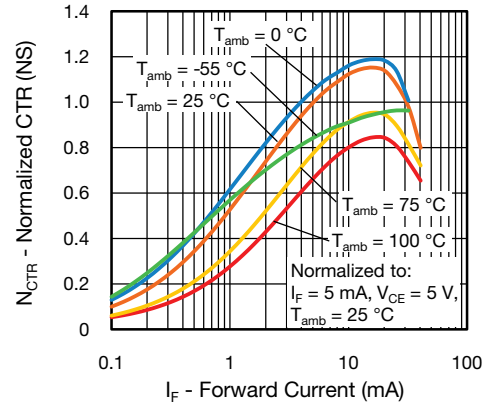


Fig. 6 - Normalized CTR (non-saturated) vs. Forward Current

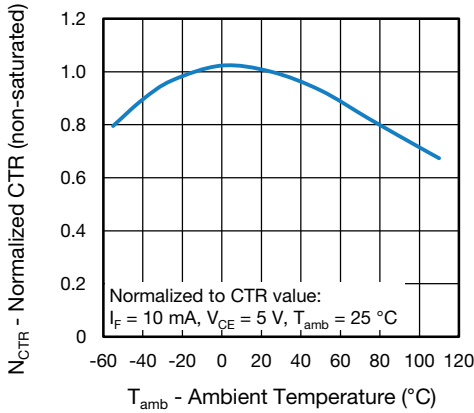


Fig. 4 - Normalized Current Transfer Ratio (non-saturated) vs. Ambient Temperature

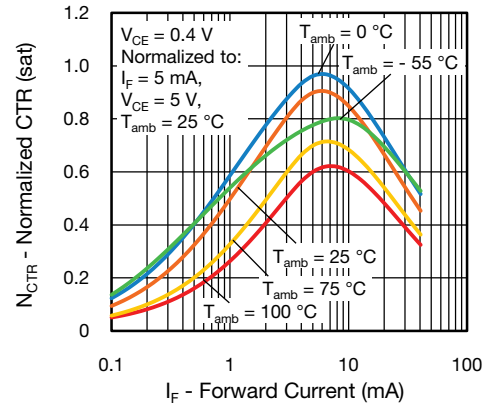


Fig. 7 - Normalized CTR (saturated) vs. Forward Current

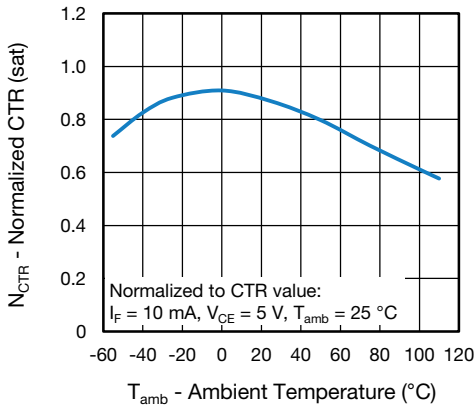


Fig. 5 - Normalized Current Transfer Ratio (saturated) vs. Ambient Temperature

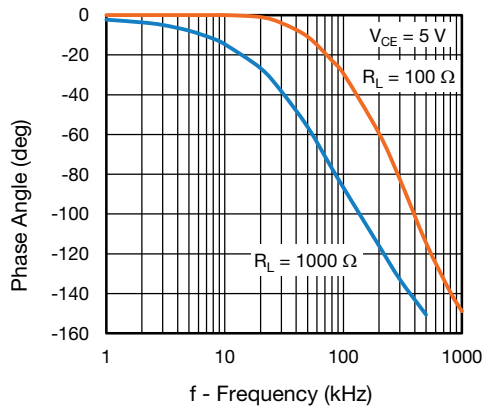


Fig. 8 - Phase Angle vs. Frequency

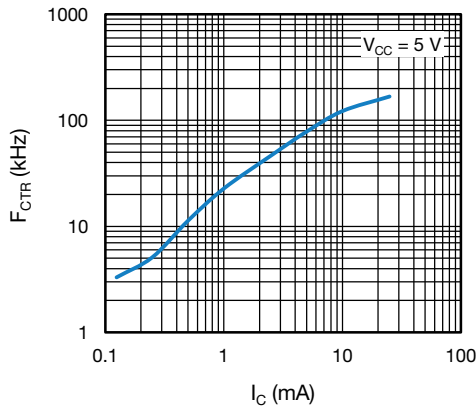


Fig. 9 - CTR Frequency vs. Collector Current

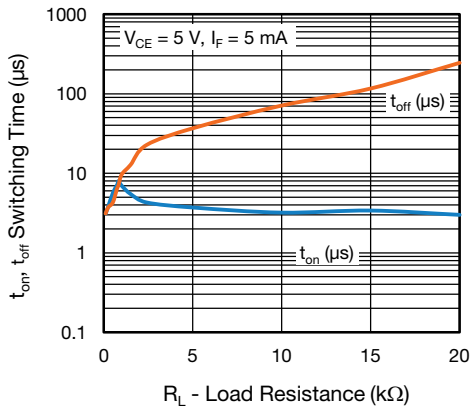


Fig. 10 - Switching Time vs. Load Resistance

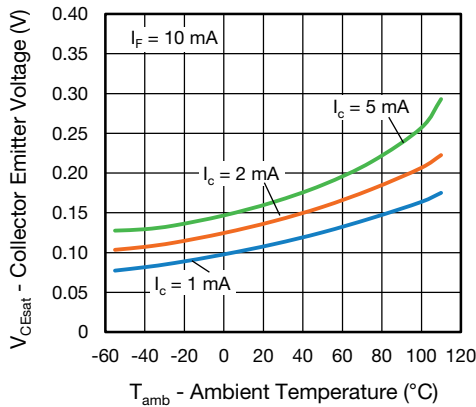
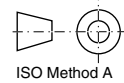
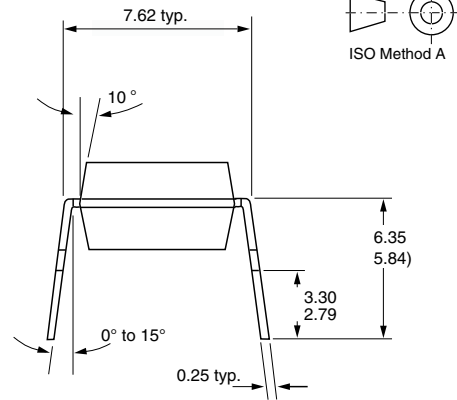
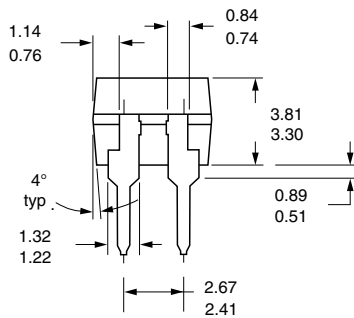
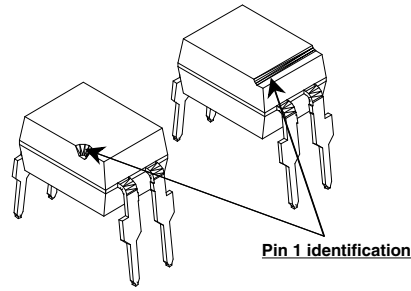
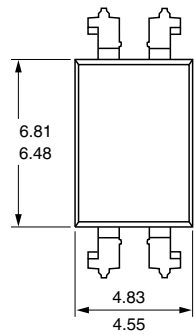


Fig. 11 - Collector Emitter Voltage vs. Ambient Temperature (saturated)

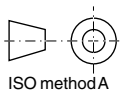
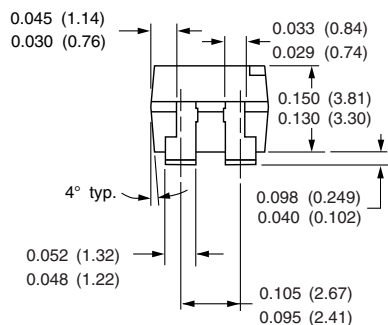
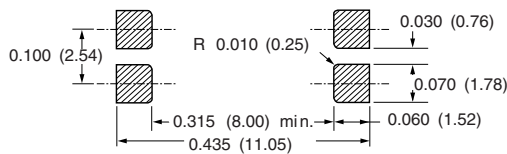
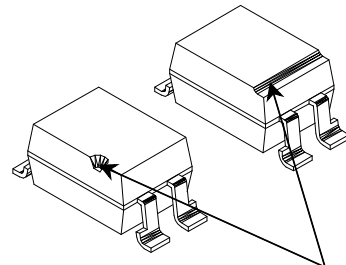
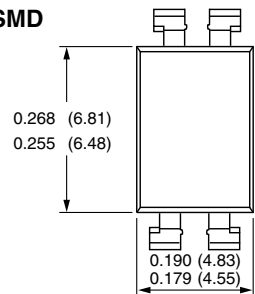


### PACKAGE DIMENSIONS in inches (millimeters)

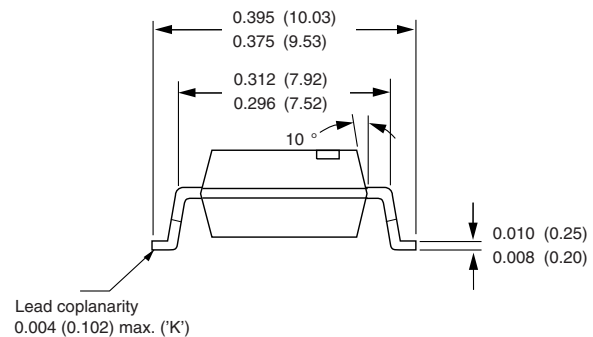


i178027-1

### SMD

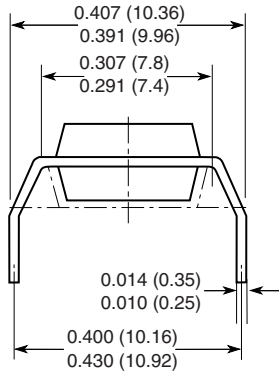


i178029-2

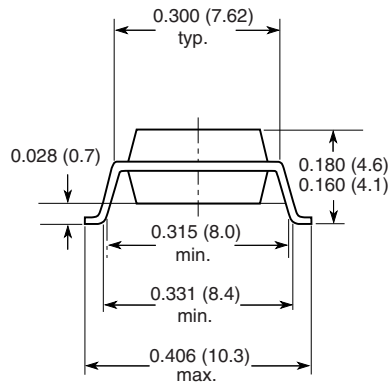




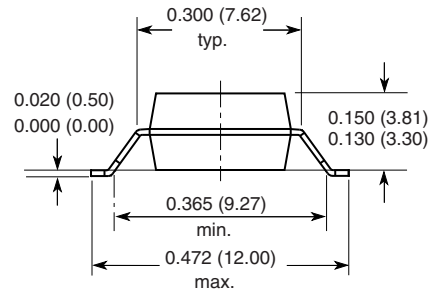
### Option 6



### Option 7

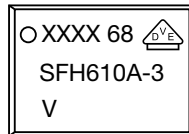


### Option 8



18487

### PACKAGE MARKING (example of SFH610A-3X001)



#### Notes

- XXXX = LMC (lot marking code)
- VDE logo is only marked on option 1 parts
- Tape and reel suffix (T) is not part of the package marking



## Disclaimer

ALL PRODUCT, PRODUCT SPECIFICATIONS AND DATA ARE SUBJECT TO CHANGE WITHOUT NOTICE TO IMPROVE RELIABILITY, FUNCTION OR DESIGN OR OTHERWISE.

Vishay Intertechnology, Inc., its affiliates, agents, and employees, and all persons acting on its or their behalf (collectively, "Vishay"), disclaim any and all liability for any errors, inaccuracies or incompleteness contained in any datasheet or in any other disclosure relating to any product.

Vishay makes no warranty, representation or guarantee regarding the suitability of the products for any particular purpose or the continuing production of any product. To the maximum extent permitted by applicable law, Vishay disclaims (i) any and all liability arising out of the application or use of any product, (ii) any and all liability, including without limitation special, consequential or incidental damages, and (iii) any and all implied warranties, including warranties of fitness for particular purpose, non-infringement and merchantability.

Statements regarding the suitability of products for certain types of applications are based on Vishay's knowledge of typical requirements that are often placed on Vishay products in generic applications. Such statements are not binding statements about the suitability of products for a particular application. It is the customer's responsibility to validate that a particular product with the properties described in the product specification is suitable for use in a particular application. Parameters provided in datasheets and / or specifications may vary in different applications and performance may vary over time. All operating parameters, including typical parameters, must be validated for each customer application by the customer's technical experts. Product specifications do not expand or otherwise modify Vishay's terms and conditions of purchase, including but not limited to the warranty expressed therein.

Hyperlinks included in this datasheet may direct users to third-party websites. These links are provided as a convenience and for informational purposes only. Inclusion of these hyperlinks does not constitute an endorsement or an approval by Vishay of any of the products, services or opinions of the corporation, organization or individual associated with the third-party website. Vishay disclaims any and all liability and bears no responsibility for the accuracy, legality or content of the third-party website or for that of subsequent links.

Except as expressly indicated in writing, Vishay products are not designed for use in medical, life-saving, or life-sustaining applications or for any other application in which the failure of the Vishay product could result in personal injury or death. Customers using or selling Vishay products not expressly indicated for use in such applications do so at their own risk. Please contact authorized Vishay personnel to obtain written terms and conditions regarding products designed for such applications.

No license, express or implied, by estoppel or otherwise, to any intellectual property rights is granted by this document or by any conduct of Vishay. Product names and markings noted herein may be trademarks of their respective owners.

## Looking for pricing, stock, or lifecycle information?

Click below to explore more details on WIN SOURCE:

 [View SFH6106-4X001T on WIN SOURCE](#)

 [Vishay Information](#)

## Optimize Your Supply Chain with WIN SOURCE Solutions

-  Global Sourcing Solution
-  Obsolete Management
-  Cost Control Management
-  Shortage Management
-  Alternative Solution
-  Excess Inventory Management