



**THE DATASHEET OF
SFH601-4X017**



Optocoupler, Phototransistor Output, With Base Connection



23030



FEATURES

- Isolation test voltage, 5000 V_{RMS}
- Low coupling capacitance
- High common mode transient immunity
- Storage temperature, -55 ° to +150 °C
- Material categorization:
for definitions of compliance please see www.vishay.com/doc?99912



RoHS
COMPLIANT
HALOGEN
FREE
GREEN
(5-2008)

APPLICATIONS

- Telecom
- Industrial controls
- Battery powered equipment
- Office machines
- Programmable controllers

AGENCY APPROVALS

- [UL](#)
- [cUL](#)
- [DIN EN 60747-5-5 \(VDE 0884-5\) available with option 1](#)
- [CQC](#)

DESIGN SUPPORT TOOLS AVAILABLE



DESCRIPTION

The SFH601 has a GaAs infrared emitting diode emitter, which is optically coupled to a silicon planar phototransistor detector, and is incorporated in a plastic DIP-6 package.

It features a high current transfer ratio, low coupling capacitance, and high isolation voltage.

The coupling device is designed for signal transmission between two electrically separated circuits.

ORDERING INFORMATION

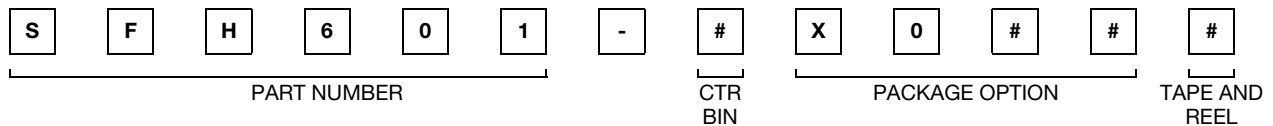

AGENCY CERTIFIED/PACKAGE	CTR (%)			
UL, cUL, CQC	40 to 80	63 to 125	100 to 200	160 to 320
DIP-6	SFH601-1	SFH601-2	SFH601-3	-
SMD-6, option 7	-	-	SFH601-3X007T	SFH601-4X007T
SMD-6, option 9	-	-	SFH601-3X009	-
VDE, UL, cUL, CQC	40 to 80	63 to 125	100 to 200	160 to 320
DIP-6, 400 mil, option 6	-	SFH601-2X016	SFH601-3X016	-
SMD-6, option 7	-	-	SFH601-3X017T	-

Note

- Additional options may be possible, please contact sales office

ABSOLUTE MAXIMUM RATINGS ($T_{amb} = 25\text{ }^{\circ}\text{C}$, unless otherwise specified)				
PARAMETER	TEST CONDITION	SYMBOL	VALUE	UNIT
INPUT				
Reverse voltage		V_R	6	V
Forward current		I_F	60	mA
Total power dissipation		P_{diss}	100	mW
OUTPUT				
Collector emitter voltage		V_{CEO}	100	V
Emitter base voltage		V_{EBO}	7	V
Collector current		I_C	50	mA
Power dissipation		P_{diss}	150	mW
COUPLER				
Storage temperature range		T_{stg}	-55 to +150	$^{\circ}\text{C}$
Ambient temperature range		T_{amb}	-55 to +100	$^{\circ}\text{C}$
Soldering temperature	$t = 10\text{ s}$	T_{sld}	260	$^{\circ}\text{C}$

Note

- Stresses in excess of the absolute maximum ratings can cause permanent damage to the device. Functional operation of the device is not implied at these or any other conditions in excess of those given in the operational sections of this document. Exposure to absolute maximum ratings for extended periods of the time can adversely affect reliability

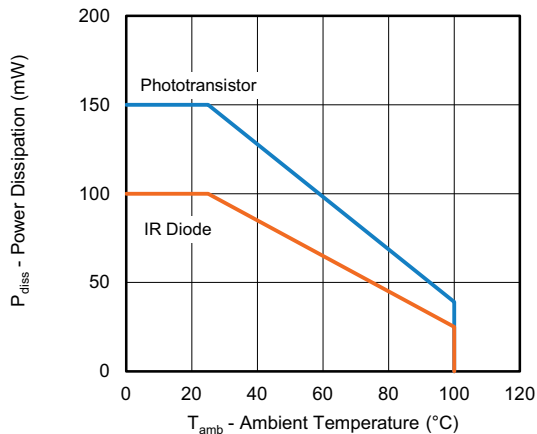

Fig. 1 - Power Dissipation vs. Ambient Temperature

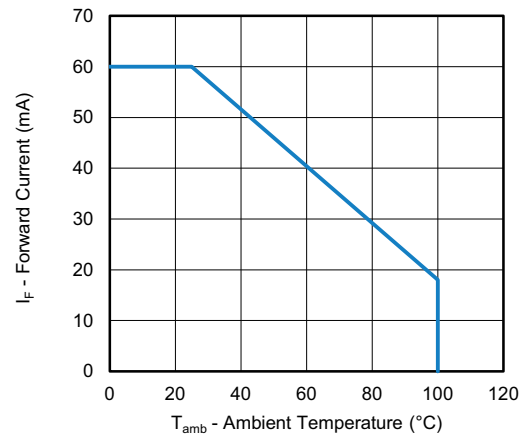

Fig. 2 - Maximum Forward Current vs. Ambient Temperature

ELECTRICAL CHARACTERISTICS ($T_{amb} = 25\text{ }^{\circ}\text{C}$, unless otherwise specified)						
PARAMETER	TEST CONDITION	SYMBOL	MIN.	TYP.	MAX.	UNIT
INPUT						
Forward voltage	$I_F = 60\text{ mA}$	V_F	-	1.45	1.65	V
Breakdown voltage	$I_R = 10\text{ }\mu\text{A}$	V_{BR}	6	-	-	V
Reverse current	$V_R = 6\text{ V}$	I_R	-	0.01	10	μA
Capacitance	$V_F = 0\text{ V}$, $f = 1\text{ kHz}$	C_I	-	-	100	pF
OUTPUT						
Collector emitter leakage current	$V_{CE} = 10\text{ V}$	I_{CEO}	-	2	50	nA
COUPLER						
Collector emitter saturation voltage	$I_F = 10\text{ mA}$, $I_C = 2.5\text{ mA}$	V_{CEsat}	-	0.125	0.4	V
Coupling capacitance	$V_{I-O} = 0$, $f = 1\text{ MHz}$	C_{IO}	-	0.6	-	pF

Note

- Minimum and maximum values are testing requirements. Typical values are characteristics of the device and are the result of engineering evaluation. Typical values are for information only and are not part of the testing requirements

CURRENT TRANSFER RATIO							
PARAMETER	TEST CONDITION	PART	SYMBOL	MIN.	TYP.	MAX.	UNIT
I_C/I_F	$I_F = 10 \text{ mA}, V_{CE} = 5 \text{ V}$	SFH601-1	CTR	40	-	80	%
		SFH601-2	CTR	63	-	125	%
		SFH601-3	CTR	100	-	200	%
		SFH601-4	CTR	160	-	320	%

SWITCHING CHARACTERISTICS						
PARAMETER	TEST CONDITION	SYMBOL	MIN.	TYP.	MAX.	UNIT
Turn-on time	$V_{CC} = 5 \text{ V}, I_C = 2 \text{ mA}, R_L = 100 \Omega$	t_{on}	-	3	-	μs
Turn-off time	$V_{CC} = 5 \text{ V}, I_C = 2 \text{ mA}, R_L = 100 \Omega$	t_{off}	-	3	-	μs

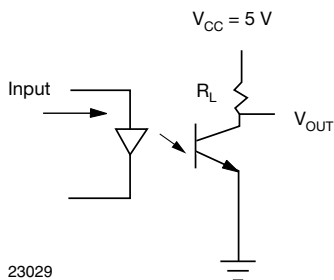

Fig. 3 - Test Circuit for Switching Characteristics

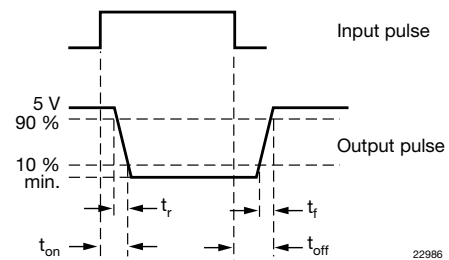

Fig. 4 - Parameter and Limit Definition

SAFETY AND INSULATION RATINGS				
PARAMETER	TEST CONDITION	SYMBOL	VALUE	UNIT
Climatic classification	According to IEC 68 part 1		55 / 115 / 21	
Pollution degree	According to DIN VDE 0109		2	
Comparative tracking index	Insulation group IIIa	CTI	175	
Maximum rated withstanding isolation voltage	According to UL1577, $t = 1 \text{ min}$	V_{ISO}	5000	V_{RMS}
Maximum transient isolation voltage	According to DIN EN 60747-5-5	V_{IOTM}	8000	V_{peak}
Maximum repetitive peak isolation voltage	According to DIN EN 60747-5-5	V_{IORM}	890	V_{peak}
Isolation resistance	$T_{amb} = 25 \text{ }^\circ\text{C}, V_{IO} = 500 \text{ V}$	R_{IO}	$\geq 10^{12}$	Ω
	$T_{amb} = 100 \text{ }^\circ\text{C}, V_{IO} = 500 \text{ V}$	R_{IO}	$\geq 10^{11}$	Ω
Output safety power		P_{SO}	700	mW
Input safety current		I_{SI}	400	mA
Input safety temperature		T_{SI}	175	$^\circ\text{C}$
Creepage distance	DIP-6, SMD-6		≥ 7	mm
Clearance distance			≥ 7	mm
Creepage distance	DIP-6, 400 mil		≥ 8	mm
Clearance distance			≥ 8	mm
Insulation thickness		DTI	≥ 0.4	mm

Note

- As per IEC 60747-5-5, § 7.4.3.8.2, this optocoupler is suitable for “safe electrical insulation” only within the safety ratings. Compliance with the safety ratings shall be ensured by means of protective circuits

TYPICAL CHARACTERISTICS ($T_{amb} = 25\text{ }^{\circ}\text{C}$, unless otherwise specified)

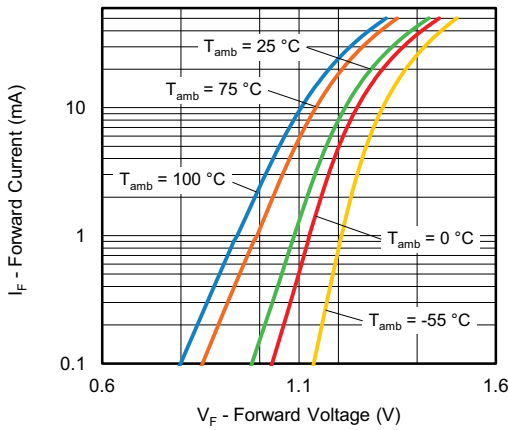

Fig. 5 - Forward Current vs. Forward Voltage

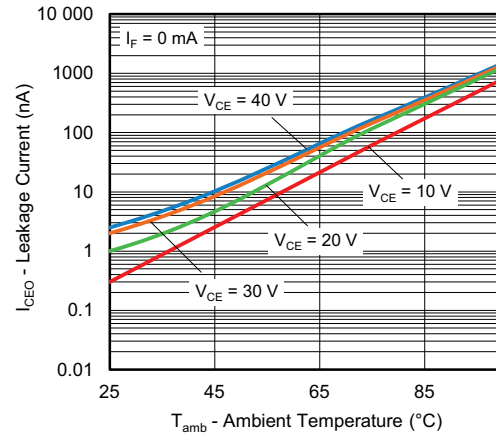

Fig. 8 - Leakage Current vs. Ambient Temperature

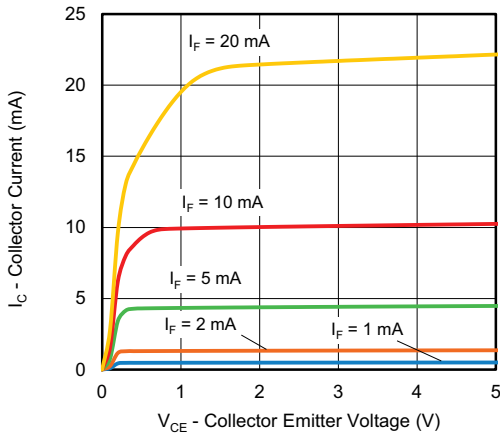

Fig. 6 - Collector Current vs. Collector Emitter Voltage (non-saturated)

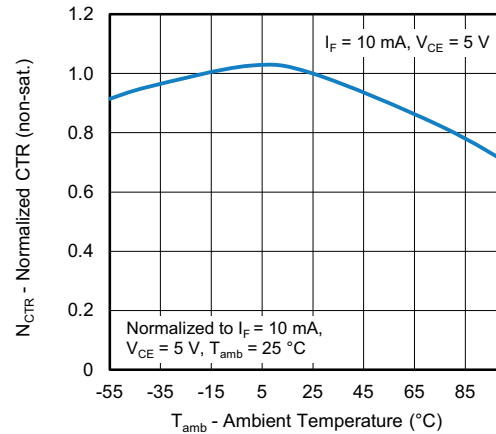

Fig. 9 - Normalized CTR vs. Ambient Temperature (non-saturated)

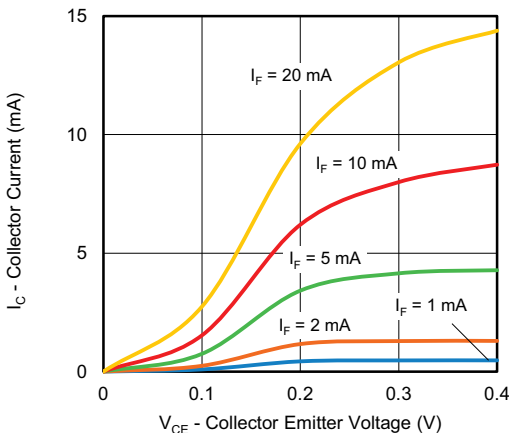

Fig. 7 - Collector Current vs. Collector Emitter Voltage (saturated)

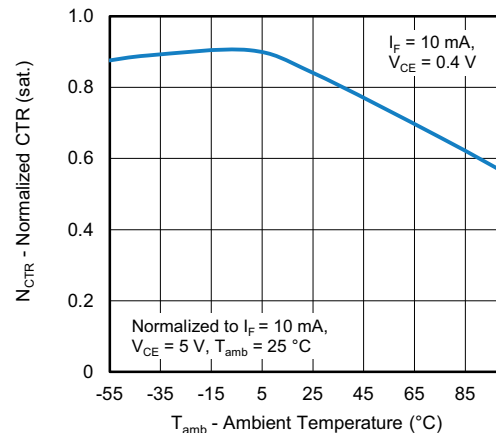

Fig. 10 - Normalized CTR vs. Ambient Temperature (saturated)

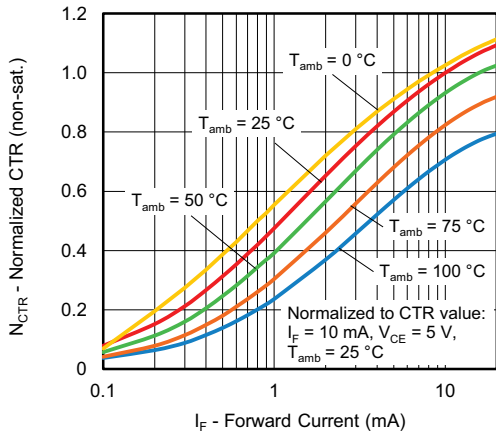

Fig. 11 - Normalized CTR vs. Forward Current (non-saturated)

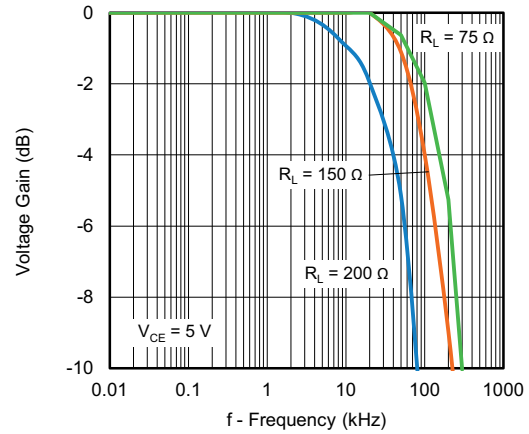

Fig. 13 - Voltage Gain vs. Frequency

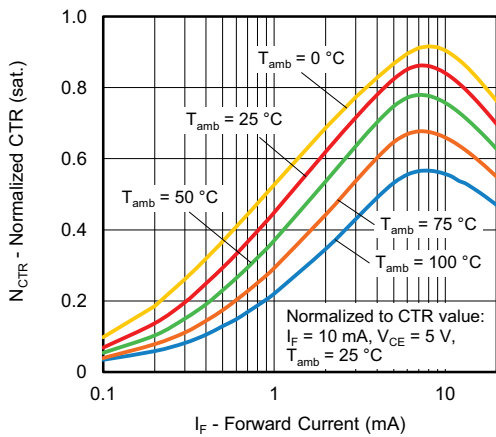

Fig. 12 - Normalized CTR vs. Forward Current (saturated)

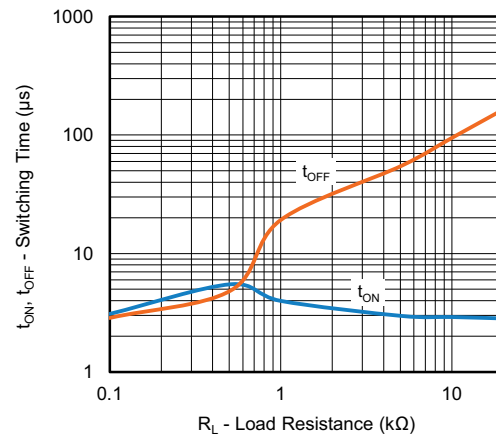
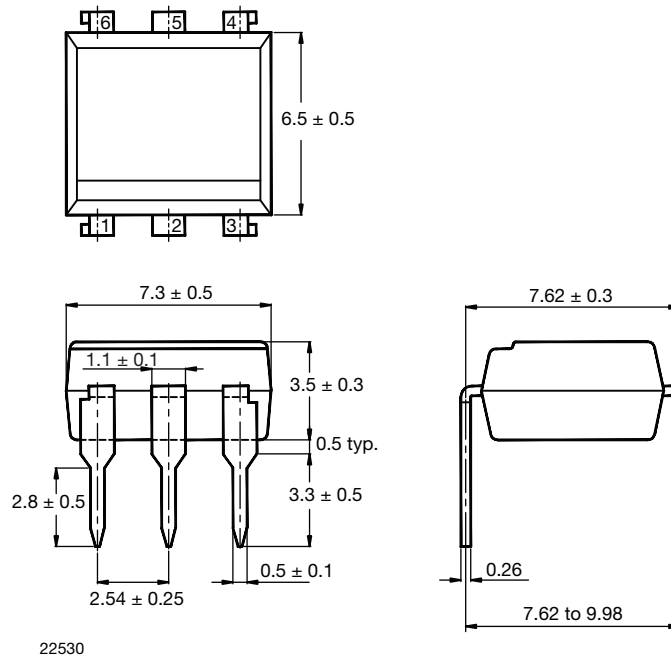

Fig. 14 - Switching Time vs. Load Resistance

PACKAGE DIMENSIONS in millimeters

6 Pin Package



22530

Option 6

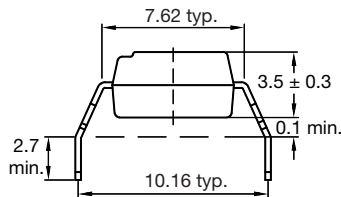

20802-52

Option 7

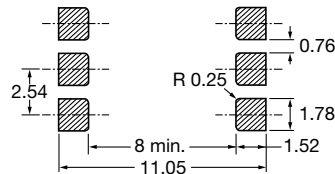
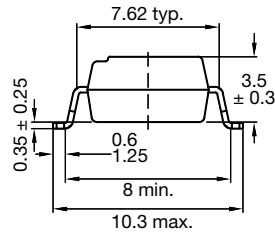

Option 9

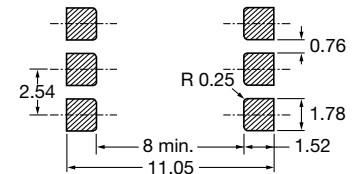
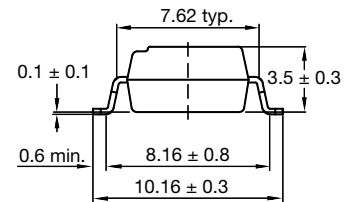

PACKAGE MARKING

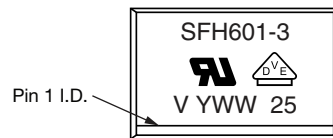

Fig. 15 - Example of SFH601

Notes

- “YWW” is the date code marking (Y = year code, WW = week code)
- VDE logo is only marked on VDE option parts
- Tape and reel suffix (T) is not part of the package marking

PACKAGING INFORMATION (in millimeters)

DEVICES PER TUBE			
TYPE	UNITS/TUBE	TUBES/BOX	UNITS/BOX
DIP-6	50	40	2000
DIP-6, option 6	50	40	2000
SMD-6, option 9	50	40	2000

DIP-6

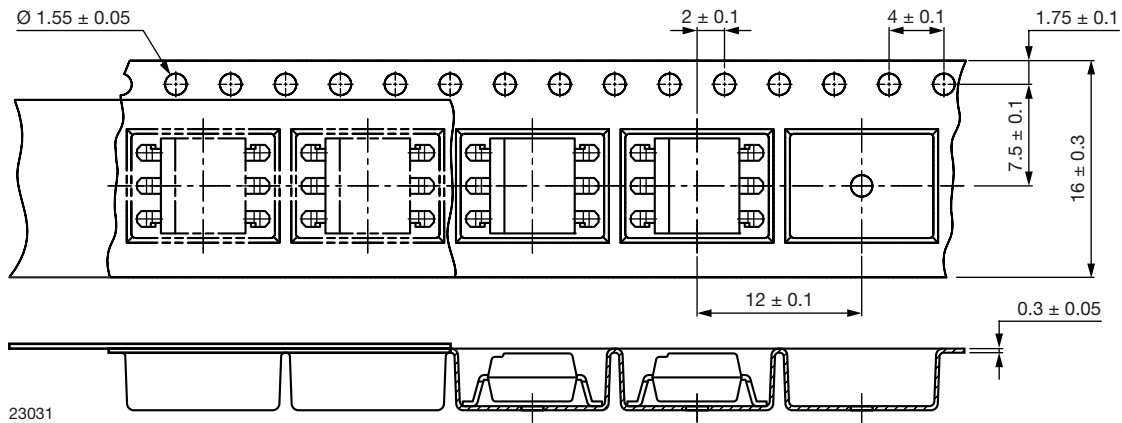
SMD-6

Reel



Fig. 18 - Tape and Reel Shipping Medium

SOLDER PROFILES

IR Reflow Soldering (JEDEC® J-STD-020C compliant)

One time soldering reflow is recommended within the condition of temperature and time profile shown below. Do not solder more than three times.

PROFILE ITEM	CONDITIONS
Preheat	
- Temperature minimum ($T_{S \text{ min.}}$)	150 °C
- Temperature maximum ($T_{S \text{ max.}}$)	200 °C
- Time (min. to max.) (t_s)	90 s ± 30 s
Soldering zone	
- Temperature (T_L)	217 °C
- Time (t_L)	60 s
Peak temperature (T_p)	260 °C
Ramp-up rate	3 °C/s max.
Ramp-down rate	3 °C/s to 6 °C/s

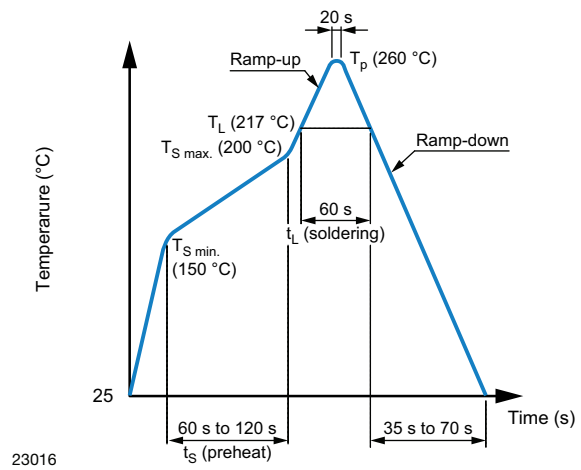

Fig. 19



Wave Soldering (JEDEC JESD22-A111 compliant)

One time soldering is recommended within the condition of temperature.

Temperature: 260 °C + 0 °C / - 5 °C

Time: 10 s

Preheat temperature: 25 °C to 140 °C

Preheat time: 30 s to 80 s

Hand Soldering by Soldering Iron

Allow single lead soldering in every single process. One time soldering is recommended.

Temperature: 380 °C + 0 °C / - 5 °C

Time: 3 s max.



23017

Fig. 20



Disclaimer

ALL PRODUCT, PRODUCT SPECIFICATIONS AND DATA ARE SUBJECT TO CHANGE WITHOUT NOTICE TO IMPROVE RELIABILITY, FUNCTION OR DESIGN OR OTHERWISE.

Vishay Intertechnology, Inc., its affiliates, agents, and employees, and all persons acting on its or their behalf (collectively, "Vishay"), disclaim any and all liability for any errors, inaccuracies or incompleteness contained in any datasheet or in any other disclosure relating to any product.

Vishay makes no warranty, representation or guarantee regarding the suitability of the products for any particular purpose or the continuing production of any product. To the maximum extent permitted by applicable law, Vishay disclaims (i) any and all liability arising out of the application or use of any product, (ii) any and all liability, including without limitation special, consequential or incidental damages, and (iii) any and all implied warranties, including warranties of fitness for particular purpose, non-infringement and merchantability.

Statements regarding the suitability of products for certain types of applications are based on Vishay's knowledge of typical requirements that are often placed on Vishay products in generic applications. Such statements are not binding statements about the suitability of products for a particular application. It is the customer's responsibility to validate that a particular product with the properties described in the product specification is suitable for use in a particular application. Parameters provided in datasheets and / or specifications may vary in different applications and performance may vary over time. All operating parameters, including typical parameters, must be validated for each customer application by the customer's technical experts. Product specifications do not expand or otherwise modify Vishay's terms and conditions of purchase, including but not limited to the warranty expressed therein.

Hyperlinks included in this datasheet may direct users to third-party websites. These links are provided as a convenience and for informational purposes only. Inclusion of these hyperlinks does not constitute an endorsement or an approval by Vishay of any of the products, services or opinions of the corporation, organization or individual associated with the third-party website. Vishay disclaims any and all liability and bears no responsibility for the accuracy, legality or content of the third-party website or for that of subsequent links.

Except as expressly indicated in writing, Vishay products are not designed for use in medical, life-saving, or life-sustaining applications or for any other application in which the failure of the Vishay product could result in personal injury or death. Customers using or selling Vishay products not expressly indicated for use in such applications do so at their own risk. Please contact authorized Vishay personnel to obtain written terms and conditions regarding products designed for such applications.

No license, express or implied, by estoppel or otherwise, to any intellectual property rights is granted by this document or by any conduct of Vishay. Product names and markings noted herein may be trademarks of their respective owners.

Looking for pricing, stock, or lifecycle information?

Click below to explore more details on WIN SOURCE:

 [View SFH601-4X017 on WIN SOURCE](#)

 [Vishay Information](#)

Optimize Your Supply Chain with WIN SOURCE Solutions

-  Global Sourcing Solution
-  Obsolete Management
-  Cost Control Management
-  Shortage Management
-  Alternative Solution
-  Excess Inventory Management