



**THE DATASHEET OF
SLN02G72F1BF1SA-DCWRT-KD2**



swissbit®

EMBEDDED MEMORY AND STORAGE SOLUTIONS

AUTOMOTIVE COMMUNICATIONS INDUSTRIAL NETWORKING SECURITY



 made in
germany



WHY CHOOSE SWISSBIT

Swissbit, the largest independent embedded memory and storage solutions manufacturer in Europe, was created through a management buyout from Siemens Semiconductor in 2001. With over 20 years of experience in the memory and storage industry, Swissbit has become a world class leader in technology supplying high quality, high reliability memory and storage solutions with all established DRAM and Flash interfaces.

Overview of services Swissbit is offering its customers:

PRODUCTS

- Complete line of DRAM modules and NAND Flash Solid State Drives with industry standard interfaces and form factors
- Both leading edge technology and legacy product offerings
- Extended and industrial temperature grade products
- Chip-On-Board (COB) and System-in-Package technology
- Small form factor removable NAND Flash cards
- Memory in-Package solutions
- Mobile Security Solutions, like Secure microSD, SD and more
- Security firmware, drivers and SDK

SALES SERVICE AND ENGINEERING SUPPORT

- Fast, effective, and competent sales staff on hand to serve your needs
- Our expert technical staff is available for quick response
- Joint product qualification service
- In-house manufacturing in Germany
- Design-in support

CUSTOMIZATION

- Custom memory and storage solutions
- Security features
- Individual marking
- Conformal coating

OEM SERVICES

- Controlled bill of materials (BOM)
- Serialization and lot code tracking
- Support of long life cycles
- Stringent PCN and ECN process

TEST FOR RELIABILITY

- Final extended and industrial temperature testing with KTI and Tanisys Technology equipment
- World class Swissbit application testing
- System Level Test During Burn-In (TDBI)
- Environmental testing according to industrial and automotive standards

COMPLIANCE WITH

- JEDEC, SDA, CFA, USB-IF, SATA-IO
- RoHS, REACH, and WEEE
- UL
- FCC, CE

QUALITY STANDARDS

- ISO 9001:2008
- TS 16949
- ISO 14001

ASSOCIATIONS

- JEDEC
- CompactFlash Association (CFA)
- SATA-IO
- USB Implementer Forum
- Secure Digital Association (SDA)
- Memory Implementers Forum
- Small Form Factor Special Interest Group SFF-SIG



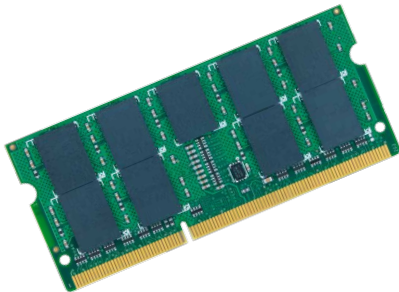

INTRODUCTION

Swissbit Target Applications 4
 Swissbit Product Features 6
 Swissbit's Unique 360°
 Customer Service 8

STORAGE SOLUTIONS

Flash Storage Solutions 9
 2.5" PATA & SATA SSDs 10
 SATA SSD Modules 12
 SATA SSD Modules SLC 13
 SATA SSD Modules MLC 15
 Flash Life Time Prediction 14
 CFast™ cards 16
 CompactFlash™ cards 18
 microSD memory cards 20
 SD memory cards 22
 USB Flash Drives / Modules 24

SECURITY SOLUTIONS

Security Products 26
 Security microSD card 28

MEMORY SOLUTIONS

Unbuffered DIMMs 33
 SODIMMs 33
 XRDIMMs 33
 Mini / Micro DIMMs 33
 Module Options 34
 Mini RDIMMs 35
 SORDIMMs 35
 Registered DIMMs 35

TECHNOLOGY

System-in-Package (SiP) 36

PART NUMBER DECODERS

Storage and Security
 Part Numbers 38
 Memory Solutions
 Part Numbers 39
 Global Presence 40

INDUSTRY

Typical applications:

Industrial Automation

- Process- / motion control
- Industrial PC / embedded
- industrial measurement
- Building technology
- Identification / access systems
- Surveillance

Energy

- Energy distribution
- Energy consumption
- Smart grid

Infotainment

- POS terminals
- Information terminals
- Ticket- / vending terminals
- Digital signage and advertising
- Casino gaming
- VLTs & lottery terminals

Healthcare

- Diagnostics
- Point of care testing
- Mobil systems
- Imaging

Transportation

- Train Control and Monitoring Systems (TCMS)
- Multifunctional terminals
- Data recorders

Aerospace and defense

- In-flight Entertainment & Communication (IFE&C)
- Communications, Command, Control and Intelligence (C4ISR)
- Combat management systems
- Battlefield sensor systems

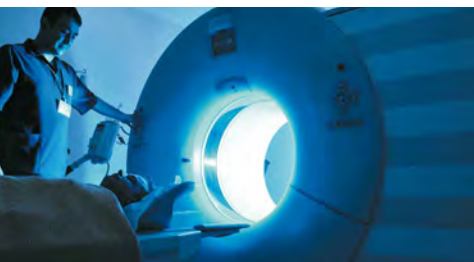

Memory and non-volatile storage solutions for embedded applications must provide reliable operation even in the most extreme conditions (e.g., temperature, shock, and vibration). As such, both the qualification cycle and the support life cycle needed for these products far exceed those of devices designed for typical consumer applications.

Swissbit's embedded memory and storage solutions are the perfect fit for such demanding applications. They offer the highest reliability and quality with long availability and controlled BOM. To guarantee such high quality standards, each product undergoes thorough functional testing before being released for shipment.

AUTOMOTIVE

Typical applications:

- Entertainment systems
- Navigation systems
- Head unit / dashboard
- Black box / crash recorder

The increasing varieties of infotainment and dashboard applications in our cars today require significantly higher storage capacities than before. All components used in automotive applications need to operate within a wide temperature range and withstand sudden power loss as well as shock and vibration. Additionally, very low failure rates are essential, because replacements of malfunctioning parts can incur high costs.

Swissbit is the only independent embedded memory and storage manufacturer with TS16949. Our new S-45 SD and microSD memory card lineup caters to the demands of an automotive application, offering the highest reliability and quality at competitive prices.



NETWORKING/COMMUNICATION

Typical applications:

- ATCA Blade
- Cable modem
- Content and video delivery
- Digital Subscriber Line access multiplexer
- Enterprise Media Gateway
- Switches and routers
- Optical network
- Radar/Sonar
- Radio network controller
- Security
- Tetra Base Station
- Wireless Base Station

Telecommunication infrastructure is implemented globally in every possible climate zone; therefore the equipment has to operate under most severe weather conditions such as heat, cold, humidity, or dust. This results in a long, expensive qualification and testing process and the need for products that guarantee long-term availability to minimize the number of requalifications.

Our cards provide features that are particularly suitable for NetCom applications, where high reliability, longer duty cycles, and on-field firmware upgrade are key requirements.

Swissbit's product portfolio is very much focused on products and form factors that will dominate the NetCom sector in the near future, such as small form factors like our newest SATA III devices including M.2, mSATA, and slimSATA. Among our solutions, we have customized products able to guarantee a high level of random performance meeting or exceeding most NetCom application requirements.

Swissbit's embedded memory and storage solutions are tested specifically for rough environmental conditions and guarantee industry leading reliability standards. Long-term relationships with our suppliers allow us to guarantee a fixed BOM along with the highest possible longevity.

SECURITY

Governments, enterprises, banks, and industry demand high-end security. Swissbit's secure storage solutions offer smart modularization of algorithms and secure storage of encryption keys in one runtime environment. Thus solution providers can concentrate fully on system design while the computation of cryptographic operations is delegated to the trusted execution environment, e.g., a smart card chip in the Flash memory device. The Swissbit Security Interface supports all relevant mobile, portable, embedded, and PC platforms.

SWISSBIT PRODUCT FEATURES



WIDE TEMPERATURE SUPPORT

Swissbit's embedded memory and storage solutions are designed and approved for reliable operation over a wide temperature range. The products are verified at temperature corners and pre-stressed with a burn-in operating functional test (Test During Burn In-TDBI).



ESD AND EMI SAFE

The product designs are in line with the latest regulations for electrostatic discharge and electromagnetic interference. Swissbit strives to exceed these limits with our own in-house technology and production capabilities, for example with System-in-Package (SiP) competence.



SHOCK AND VIBRATION

Robustness is one of our key specification targets. The design, assembly, and use of selected materials guarantee an extremely solid design, which has been validated by extensive testing.



LIFE TIME MONITORING (LTM)

The Swissbit Life Time Monitoring feature enables users to access the memory device's detailed Life Time Status and allows imminent failure prediction thereby avoiding unexpected data loss. This feature uses an extended S.M.A.R.T. (Self-Monitoring, Analysis and Reporting Technology) interface or vendor specific commands to retrieve Flash product information.



ZONE PROTECTION

The device allows the configuration of multiple zones with either no protection, write protection, or access protected settings. Each zone is secured with a separate password. A Windows tool and a programming library are available.



SECURE ERASE (SANITIZE/PURGE)/FAST ERASE

This feature uses an uninterruptable sequence of data erase commands. Even a power-off can't stop the process, which will continue upon restoration of power. The optional enhanced feature allows the customer to sanitize the data according to different standards like DoD, NSA, IREC, etc. The purge algorithm can be started by a software command or through a hardware pin.



CONFORMAL COATING

Swissbit offers a special protective coating on selected products. This coating is a thin polyurethane film, which protects against aggressive environmental conditions such as dust, moisture, or corrosive gas.



TEMPERATURE SENSOR

The sensor allows the host hardware or software to monitor memory device temperature to improve data reliability in the target application environment.



HEAT SPREADER

Heat spreader for DRAM modules allow temperature hot spots to be dissipated over a larger surface area and improve the module's reliability.



POWER FAIL PROTECTION AND RECOVERY

Intelligent power fail protection and recovery protects data from unexpected power loss. During an unintentional shutdown, firmware routines and an intelligent hardware architecture ensure that no corruption of user or system data will occur.



WEAR LEVELING

Sophisticated wear leveling and bad block management ensure that Flash cells are sparingly and equally used to prolong the device's life.



READ-ONLY OPTIMIZED

In many industrial applications, content is written to the NAND Flash once and is only read afterwards. For such cases, the firmware can be optimized to guarantee the highest possible data retention and less read disturb.



TRIM SUPPORT

The TRIM command allows the operating system to inform the SSD about which blocks of data are no longer considered in use and can be wiped internally, which increases system performance during subsequent write accesses. With TRIM support, data scrap, which would otherwise slow down future write operations to the involved blocks, can be deleted in advance.



LOW POWER CONSUMPTION

Electronic devices with lower power consumption increase the value of the product, because they decrease energy cost, prolong battery life, and reduce heat generation in the device and hence require less cooling.

**DATA CARE MANAGEMENT**

Various effects like data retention, read disturb limits, or temperature can impact data reliability. The latest generation of Swissbit products uses special methods to maintain and refresh the data for greater data integrity.

**LONGEVITY**

The longevity product lines use special components with a long-term supply commitment of up to ten years. These products offer the lowest TCO in demanding applications with high requalification cost.

SECURITY FEATURES**TRUE HARDWARE RNG**

True random numbers are generated inside the secure element. True randomness is the key prerequisite for secure systems to prevent brute force attacks.

**SECURE VOICE**

Secure Voice calls are a requirement for confidential communication. Swissbit Security products are optimal for fast, encrypted, user friendly secure voice solutions.

**DIGITAL SIGNATURE AND VERIFICATION**

Digital signatures are very popular and inevitable to protect against data or code manipulation.

**ELLIPTIC CURVE CRYPTOGRAPHY SUPPORT**

Elliptic curves are faster and more efficient than RSA cryptography.

**HARDWARE BASED DATA ENCRYPTION**

Hardware based security is key when it comes to replaceability, simple workflows, and trusted runtime environments.

**SECURE CD-ROM**

The Flash memory can be partially or totally switched to read-only. This function ensures that e.g., important data can be modified only after PIN authentication.

**MOBILE BANKING AND EPURSE**

Swissbit Security products for mobile banking and payment offer strong authentication and offline security.

**DATA PROTECTION AND ENCRYPTION**

Various data protection modes ensure privacy of stored data. The card offers a data safe function with strong AES encryption and PIN access protection.

**DEVICE PROTECTION BY DUAL FACTOR AUTHENTICATION**

The user needs to have the card and know the PIN.

**SECURE LOGGING**

In large, hidden storage, any system event log, tax data, consumption data, or audit trails can be stored securely in write-once mode, queue mode, or random access mode.

SWISSBIT'S UNIQUE 360° CUSTOMER SERVICE

PRE-SALES

YOUR FUTURE WITH OUR SOLUTION

Swissbit's experienced BDM and FAE teams in Europe, North America, and Asia support you in the selection and qualification of the most suitable memory and storage solution for your applications.

Our services include

- TCO support,
- consulting (design / concept / technology),
- qualification cycle support & joint qualification,
- evaluation units,
- hardware customization,
- firmware customization,
- middleware customization for security products, and
- consulting for your future product generations.



AFTERSALES

LOCAL SUPPORT – GLOBALLY

Our engagement stretches far beyond the delivery of our products. Through sophisticated lifecycle management, we can ensure maximum longevity and smooth transitions in the event of product changes. And while we are proud of our best-in-class quality, we are still prepared to provide fast and solution-oriented RMA support at any time, including 4D and 8D reports whenever required.

Our services include

- local high level engineering support,
- longevity of product lines – up to ten years,
- field support (including firmware upgrades),
- full product and service life support, and
- PCN process.

SALES

LOCAL SUPPORT – GLOBALLY

We understand the importance of providing local support in your language and time zone. For that reason, Swissbit has established sales offices in all major regions plus a strong network of partners that reaches even farther. Our experienced sales teams manage forecasting and order fulfillment, if desired also through third-party logistics or distribution networks.

Our services include

- Global Account and Key Account Management,
- highly sophisticated channel partners who can support sampling within 24 hours,
- fast, reliable response time,
- highly reliable inventory management using an integrated CRM/ERP/BI system for smart data analysis and forecasting.

SWISSBIT'S EMBEDDED STORAGE SOLUTIONS

OEM's of various industries require a variety of memory and storage solutions. In contrast to typical consumer devices, Swissbit's embedded memory and storage solutions are designed for highest reliability under extreme environmental conditions. They come with a large feature set tailored to the demands of the industrial, automotive, and NetCom markets and with our commitment to long-term availability.

Swissbit's embedded memory and storage solutions portfolio covers all relevant interfaces and form factors including SD and microSD memory cards, CompactFlash™ and CFast™ cards, 2.5" PATA and SATA SSDs, SLIM SATA and mSATA SSDs, M.2, USB Flash Drives (UFD) and modules. Our sophisticated Flash handling algorithms optimize performance and life of the Single Level Cell (SLC) and Multi Level Cell (MLC) NAND Flash used in our products.

Product development according to stringent design rules and extensive product qualification procedures ensures the electrical and mechanical robustness of Swissbit's embedded storage solutions. All products are offered in commercial (0°C to +70°C) and industrial (-40°C to +85°C) temperature ranges. Available Flash handling features include diagnostic information, built-in error correction, bad block management, static and dynamic wear leveling and power fail protection. Our service team can offer product life time calculations for special use cases with specific workloads. The diagnostic features we provide enable our customers to access device state information and schedule replacements before the system stops working.

	SLC	EM-MLC	MLC	TLC
Chip Capacity	++	+++	+++	++++
Cost per Bit	++++	+++	++	+
Reliability & Endurance	++++	+++	++	+
Industrial Temperature	++++	+++	+++	+
Write Performance	++++	++	+++	+
ECC Requirement	+	++	++	++++
Data Retention	++++	++	+++	+
Longevity	++++	+++	++	+

NAND FLASH TECHNOLOGY
COMPARISON

++++ highest; +++ high; ++ medium; + low

2.5" PATA & SATA SSDs



Swissbit offers various 2.5" SSDs with PATA and SATA interfaces. Swissbit's X-500 and X-55 SATA II SSDs are designed as a rugged and extremely reliable storage solution for stable operation in harsh environmental conditions such as wide temperature range, shock, vibration, or humidity. They use the most reliable SLC (X-500) or EM-MLC (X-55) NAND Flash available on the market today and comprise a large number of features. These features include various options for Secure Erase, Purge, and Sanitize methods as well as detailed, S.M.A.R.T. based Life Time Monitoring tools that allow the user to have full control of mission critical data at any given time. The BCH-ECC (error correction code) in combination with an intelligent power fail protection mechanism guarantees the highest possible data reliability. Special features such as ATA-8, NCQ, and TRIM commands enable higher sequential and random performance while providing the high level of reliability required in industrial applications. X-500 SSDs are the ideal solution for applications requiring the highest level of endurance or maximum longevity. The X-55 series were designed for industrial applications with a balanced read/write workload and offer more than ten times the endurance of SSDs using standard MLC.

The P-120 (PATA) and X-200 (SATA II) complement Swissbit's 2.5" SSD product portfolio and are an ideal fit for low- to medium-density applications. They are designed for long-term industrial use and support key requirements such as long data retention, no compromise power fail safety, and long product life cycles.

**LOCKING / LATCHING
SATA CONNECTOR**

Swissbit's X-500 and X-55 SSDs are designed with a latching SATA connector. Multiple notches support the latching cables for highest vibration and shock resistance.

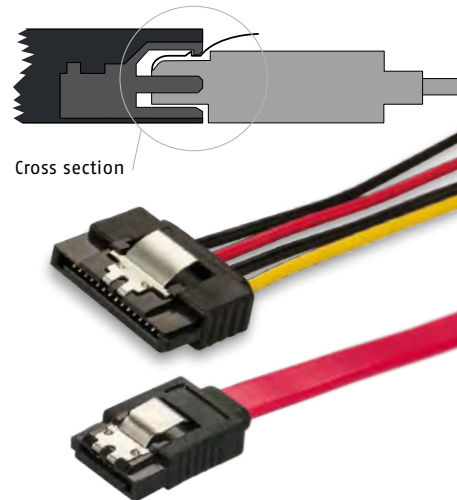

X-55	●	●	●	●	●	○	●	★	●	●	●	○
X-500	●	●	●	●	●	○	●	★	●	●	●	●
X-200	●	●	●	●	○	○	○	★	●	●	○	●
P-120	●	●	●	●	○	○	○	★	●	○	○	○

★ Industry Leading; ● default implemented; ○ on request; ◯ not available



	2.5" SATA SSD		2.5" SATA SSD		2.5" SATA SSD		2.5" PATA SSD		
Series Name	X-55		X-500		X-200		P-120		
Interface	SATA II – 3 Gbit/s							IDE / PATA	
Data Transfer Mode	up to UDMA6 / PIO4 / MDMA2							up to UDMA4 / PIO4 / MDMA2	
Connector	15 + 7 pin Serial ATA with latch protection / special feature connector				15 + 7 pin Serial ATA		ATA 44 pin, 2 mm pitch		
Outline Dimensions	100.2 x 69.85 x 9.3 mm							100.2 x 69.85 x 9 mm	
Flash Type	EM-MLC		SLC						
Density Range	30 GB – 480 GB		16 GB – 512 GB		4 GB – 8 GB		4 GB – 32 GB		
Data Retention	5 years @ life begin 3 months @ life end		10 years @ life begin 1 year @ life end						
Endurance	420 / 310 TBW (60 GB, JESD219 Client / Enterprise workload)		2700 / 370 TBW (64 GB, JESD219 Client / Enterprise workload)		100,000 P/E cycles (Flash cell level)				
Operating Temperature	Commercial: 0°C to +70°C Industrial: -40°C to +85°C								
Storage Temperature	-55°C to +95°C				-50°C to +100°C				
Performance	Burst Rate (MB/s)	up to 300	up to 300	up to 300	up to 300	up to 66	up to 66	up to 66	
	Sequential Read (MB/s)	up to 240	up to 240	up to 120	up to 120	up to 45	up to 45	up to 45	
	Sequential Write (MB/s)	up to 160	up to 220	up to 95	up to 95	up to 35	up to 35	up to 35	
	Random 4KB Read (IOPS)	up to 14,800	up to 14,500	up to 3,100	up to 3,100	up to 3,840	up to 3,840	up to 3,840	
	Random 4KB Write (IOPS)	up to 3,200	up to 5,300	up to 25	up to 25	up to 51	up to 51	up to 51	
MTBF	≥ 2,000,000 hours				≥ 2,500,000 hours				
Shock	MIL-STD810; 2,000 G, 0.4 ms; 50 G, 11 ms				1,500 G				
Vibration	MIL-STD810; 20 G, 10–2,000 Hz random				20 G				
Humidity	85 % RH 85°C, 1,000 hrs								
Voltage	5 V ± 10 % 3.3 V optional				5 V ± 10 %				
Power Consumption	Slumber 140 mA max 700 mA Idle 200 mA		max 320 mA Idle 140 mA		max 320 mA Idle 140 mA		PIO typ 55 mA max 160 mA Idle 5 mA		
Features & Tools	Proven Power Fail Safety ATA security feature set Enhanced Secure Erase, Purge and Sanitize features (MIL STD) NCQ, TRIM Advanced Wear Leveling & Bad Block management In-field firmware update SBLTM Tool & SDK for S.M.A.R.T. based Life Time Monitoring				Proven Power Fail Safety Security Features available Wear Leveling & Bad Block management SBLTM Tool & SDK for S.M.A.R.T. based Life Time Monitoring				
Part Number	SFSAXxxxQvBJxss-t-dd-rrr-ccc				SFSAXxxxQvBRxss-t-dd-rrr-ccc		SFPAXxxxQvB0xss-t-dd-rrr-ccc		

SATA SSD MODULES



Swissbit's mSATA (M0-300), SLIM SATA (M0-297), and the new M.2 SSDs are ideal solutions for embedded applications requiring solid state storage in smaller, removable form factors. Our SATA SSD modules offer a long service life combined with controlled BOM and a change notification process. Each unit undergoes extensive testing over the full temperature range before being released for shipment.

The X-60 SATA III series is Swissbit's solution for high performance, cost sensitive, high capacity markets. The SSD modules will be available as mSATA (X-60m), SLIM SATA (X-60s), and M.2 (X-60m2). They were designed for all industrial, NetCom, and automotive applications requiring high data transfer rates up to 525 MB/s in sequential access and 79,000 IOPS in 4 KB random access. In addition, they offer a wide range of features such as Swissbit's proven Power Fail Safety, ATA security feature set, Data Care Management tools, a Windows or Linux tool and SDK for detailed S.M.A.R.T.-based Life Time Monitoring, NCQ, TRIM, advanced wear leveling & bad block management and in-field firmware update functionality. The newly introduced SLC-based X-600 series are highly reliable storage solutions with outstanding endurance and are available with the same set of features as the X-60 products. They are built using the most reliable SLC Flash on the market and an industrial grade SATA III controller and operate from -40°C to +85°C.



PRODUCT SIZE COMPARISON

X-600m / X-60m	●	●	★	●	●	○	●	★	●	●	★	○
X-600s / X-60s	●	●	★	●	●	○	●	★	●	●	★	○
X-600m2 / X-60m2	●	●	★	●	●	○	●	★	●	●	★	○
X-200m	●	●	●	○	○	○	○	●	●	○	○	●
X-200s	●	●	●	○	○	○	○	●	●	○	○	●

★ Industry Leading; ● default implemented; ○ on request; ○ not available

SLC BASED MODULES



	MO-300 FULL SIZE	MO-297 SLIM SATA	M.2 2242/2260/ 2280	MO-300 FULL SIZE	MO-297 SLIM SATA
Series Name	X-600m	X-600s	X-600m2	X-200m	X-200s
Interface Data Transfer Mode	SATA III – 6 Gbit/s ATA8			SATA II – 3 Gbit/s up to PIO4, MDMA2, UDMA6	
Connector	52 pos. Edge Connector PCI Express (PCIe) mini	15 + 7 pin Serial ATA Connector	75 pos. Edge Connector B & M key	52 pos. PCI Express (PCIe) mini	15 + 7 pin Serial ATA Connector
Outline Dimensions	50.8 x 29.85 x 3.3 mm	54 x 39 x 4 mm	22 x 42/60/80 x 3.6 mm	50.8 x 29.85 x 3.3 mm	54 x 39 x 4 mm
Flash Type	SLC				
Density Range	8 GB – 120 GB	15 GB – 120 GB	8 GB – 60 GB (2242) 8 GB – 120 GB (2260/2280)	2 GB – 64 GB	
Data Retention	10 years @ life begin 1 year @ life end				
Endurance	max 9.8 TBW per GB drive capacity (per JESD219)			100,000 P/E cycles (Flash cell level)	
Operating Temperature	Commercial: 0°C to +70°C Industrial: -40°C to +85°C				
Storage Temperature	-50°C to +100°C				
Performance					
Burst Rate (MB/s)	up to 600			up to 300	
Sequential Read (MB/s)	up to 520			up to 120	
Sequential Write (MB/s)	up to 400			up to 95	
Random 4KB Read (IOPS)	up to 75,000			up to 3,100	
Random 4KB Write (IOPS)	up to 75,000			up to 25	
Voltage	3.3 V ± 5 %	5 V ± 10 %	3.3 V ± 5 %	3.3 V ± 5 %	5 V ± 10 %
Power Consumption	typ 450 mA max 800 mA Idle 110 mA	typ 300 mA max 550 mA Idle 60 mA	typ 450 mA max 800 mA Idle 110 mA	typ 300 mA max 490 mA Idle 180 mA	typ 260 mA max 320 mA Idle 140 mA
Features & Tools	Proven Power Fail Safety NCQ, TRIM Advanced Wear Leveling & Bad Block management In-field firmware update SBLTM Tool & SDK for S.M.A.R.T. based Life Time Monitoring			Proven Power Fail Safety Advanced Wear Leveling & Bad Block management SBLTM Tool & SDK for S.M.A.R.T. based Life Time Monitoring	
Part Number	SFSAxxxxUvAAxss-t-dd- rrr-ccc	SFSAxxxxVvAAxss-t-dd- rrr-ccc	SFSAxxxxMvAAxss-t-dd- rrr-ccc	SFSAxxxxUvBRxss-t-dd- rrr-ccc	SFSAxxxxVvBRxss-t-dd- rrr-ccc

X-600 series: target specification

FLASH LIFE TIME PREDICTION



The endurance of Flash based products is one of the most controversial aspects of this technology. NAND Flash component suppliers specify the endurance of their products based on the number of allowed PE (program / erase) cycles before Flash cell degradation reaches a level exceeding the controller's error correction capability. SLC components allow 100,000 PE cycles per block while MLC is typically specified as 3,000 PE cycles. This transparency of NAND component endurance is no longer provided for integrated Flash cards with controllers and firmware. For each write that the host initiates, the Flash controller has to perform internal management steps and may need to erase and write multiple blocks even at the smallest external write transfer size. The ratio between internal write data volume and the external request size is called WAF (write amplification factor). The WAF can vary between one (theoretical best case) and several hundred depending on card structure, Flash components used, firmware architecture, and user-application write profile. The WAF directly influences the IOPS rate but the endurance even more. With a WAF of 100, internal PE cycles are 100 times greater than expected from the external data rate, and the endurance limit is reached 100 times faster than anticipated. Customer application use cases have a huge impact on the WAF. For example data base applications can cause catastrophic numbers of small writes to the disk that wear out the Flash in shortest time frame. In most cases, how the software's access profile will translate into Flash writes can hardly be predicted.

Swissbit supports a realistic prediction of the WAF and the endurance of their SSDs and storage cards with help of the Swissbit Life Time Monitoring Tool and statistical data stored into the Flash by the firmware. This tool can read out usage data such as number of writes, number of erase cycles, the bad block statistic, the successful ECC correction, and much more.

The realistic predicted endurance can be calculated following this procedure:

- Dump the status of a Swissbit Flash product as initial state with help of the Swissbit Life Time Monitor.
- Run your real-life application for a defined period of time, e.g., seven days.
- Dump the product's status after finishing the test run.

Send the initial and final dump to the Swissbit FAE team which will happily provide you with the calculated life expectancy of this card in your application.

If you have confidential applications where you don't want to disclose the results, Swissbit will instruct you how to extrapolate the recorded number of PE cycles into the life expectancy.

The Swissbit Life Time Monitor can also be used to visualize the detailed S.M.A.R.T. status and history of Swissbit's Flash products.

The Swissbit Life Time Monitor is available as stand-alone executables for Windows or Linux, or as an API to be integrated into the customer's software architecture. Swissbit also offers to port the tool into an existing embedded application.

The monitor can be run as a background process in minimized mode in the system tray where it displays the current device S.M.A.R.T. status and performs periodic snapshots of the statistical values for a complete device life history.

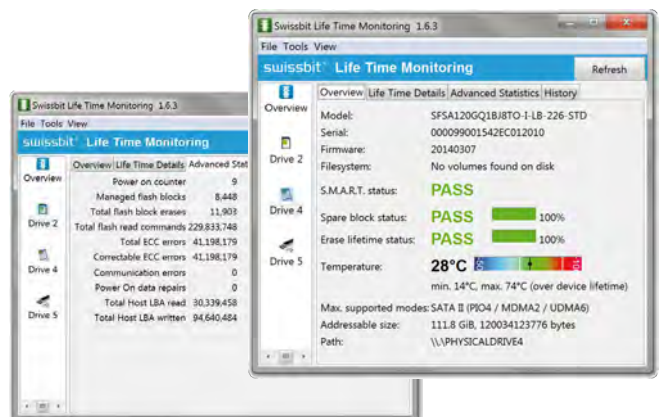

MLC BASED MODULES



	MO-300 FULL SIZE	MO-297 SLIM SATA	M.2 2242/2260/ 2280
Series Name	X-60m	X-60s	X-60m2
Interface	SATA III – 6 Gbit/s		
Data Transfer Mode	ATA8		
Connector	52 pos. Edge Connector PCI Express (PCIe) mini	15 + 7 pin Serial ATA Connector	75 pos. Edge Connector B & M key
Outline Dimensions	50.8 x 29.85 x 3.3 mm	54 x 39 x 4 mm	22 x 42/60/80 x 3.6 mm
Flash Type	MLC		
Density Range	8 GB – 480 GB		30 GB – 240 GB (2242) 30 GB – 480 GB (2260/2280)
Data Retention	10 years @ life begin 1 year @ life end		
Endurance	max. 1.9 TBW per GB drive capacity (per JESD219)		
Operating Temperature	Commercial: 0°C to +70°C Industrial: -40°C to +85°C		
Storage Temperature	-50°C to +95°C		
Performance	Burst Rate (MB/s) up to 600 Sequential Read (MB/s) up to 525 Sequential Write (MB/s) up to 450 Random 4KB Read (IOPS) up to 75,000 Random 4KB Write (IOPS) up to 79,000		
Voltage	3.3 V ± 5 %	5 V ± 10 %	3.3 V ± 5 %
Power Consumption	typ 450 mA max 800 mA Idle 110 mA	typ 300 mA max 550 mA Idle 60 mA	typ 450 mA max 800 mA Idle 110 mA
Features & Tools	Proven Power Fail Safety NCQ, TRIM Advanced Wear Leveling & Bad Block management In-field firmware update SBLTM Tool & SDK for S.M.A.R.T. based Life Time Monitoring		
Part Number	SFSAxxxxUvAAxss-t-dd-rrr-ccc	SFSAxxxxVvAAxss-t-dd-rrr-ccc	SFSAxxxxMvAAxss-t-dd-rrr-ccc

X-60 series: target specification



CFast™ CARDS

CFast™ cards combine two existing industry standards into a single product: the CompactFlash™ (CF) card form factor and the Serial ATA (SATA) interface commonly used in hard disks. CFast™ cards can replace both HDDs and CompactFlash™ cards in applications requiring small form factors, high endurance and the ability to withstand shock, vibration, extreme temperatures (-40°C to +85°C), high altitude and rough environmental conditions. Swissbit's CFast™ cards provide rugged storage for embedded and industrial systems where performance, data and system reliability, power fail protection and flexibility are important design considerations.

Swissbit CFast™ cards operate with a 3.3 Volt low power source and support three SATA power management states: Active, Partial, and Slumber. This standard is a perfect choice for both boot devices and as removable media for applications requiring low to medium storage densities with a small footprint. Additionally, the Swissbit CFast™ cards come with full engineering and customization support, S.M.A.R.T. based Life Time Monitoring features, our intelligent Flash Management algorithms and Error Correction, guaranteeing the highest level of reliability even in rough application environments.

Swissbit's latest innovations are the F-60/F-600 SATA III CFast™ card series. Using state of the art controllers and MLC/SLC Flash technology, the F-60/F-600 achieve data transfer rates up to 525 MB/s in sequential access and 70,000 IOPS in 4KB random access. In addition, the F-60/F-600 series feature Swissbit's proven Power Fail Safety, ATA security feature set, enhanced Secure Erase tools, a Windows or Linux tool and SDK for detailed S.M.A.R.T.-based Life Time Monitoring, NCQ, TRIM, advanced wear leveling and bad block management or in-field firmware update functionality.

F-600	●	●	●	★	●	○	●	★	●	●	●	★	○
F-60	●	●	●	★	●	○	●	★	●	●	●	★	○
F-240	●	●	●	★	○	○	○	★	●	★	●	○	●

★ Industry Leading; ● default implemented; ○ on request; ○ not available



	CFAST™ CARD		CFAST™ CARD		CFAST™ CARD	
Series Name	F-600		F-60		F-240	
Interface	CFast™ 2.0 - SATA III - 6 Gbit/s				CFast™ 1.0 - SATA II - 3 Gbit/s	
Data Transfer Mode	ATA8				ATA7	
Connector	CFast™ Type I					
Outline Dimensions	36.4 x 42.8 x 3.6 mm					
Flash Type	SLC		MLC		SLC	
Density Range	8 GB - 60 GB		16 GB - 240 GB		2 GB - 64 GB	
Data Retention	10 years @ life begin 1 year @ life end					
Endurance	9.8 TBW per GB drive capacity		1.9 TBW per GB drive capacity		100,000 P/E cycles (Flash cell level)	
Operating Temperature	Commercial: 0°C to +70°C Industrial: -40°C to +85°C					
Storage Temperature	-50°C to +100°C					
Performance						
Burst Rate (MB/s)	up to 600		up to 600		up to 300	
Sequential Read (MB/s)	up to 520		up to 525		up to 130	
Sequential Write (MB/s)	up to 340		up to 340		up to 100	
Random 4KB Read (IOPS)	up to 70,000		up to 70,000		up to 3,300	
Random 4KB Write (IOPS)	up to 40,000		up to 40,000		up to 95	
MTBF	≥ 2,500,000 hours					
Shock	1,500 G					
Vibration	20 G					
Humidity	85% RH 85°C, 1,000 hrs					
Voltage	3.3 V ± 5 %					
Power Consumption	typ 450 mA max 650 mA		typ 450 mA max 650 mA		typ 140 mA max 250 mA Idle 55 mA PHYSLP <20 mA	
Features & Tools	Proven Power Fail Safety NCQ, TRIM Advanced Wear Leveling & Bad Block management In-field firmware update SBLTM Tool & SDK for S.M.A.R.T. based Life Time Monitoring				Proven Power Fail Safety Sophisticated Wear Leveling & Bad Block management Read Disturb Management TRIM Low Power Consumption Security & SBZoneProtection features available SBLTM Tool & SDK for S.M.A.R.T. based Life Time Monitoring Evaluation kit with 2.5" SATA adapter board available	
Part Number	SFCxxxxHvAAxss-t-dd-rrr-ccc		SFCxxxxHvAAxss-t-dd-rrr-ccc		SFCxxxxHvBVxss-t-dd-rrr-ccc	

F-600 series: target specification

CompactFlash™ CARDS

To this day, CompactFlash™ (CF) cards are still the most popular Flash-based storage solution used in the embedded and industrial markets and the CompactFlash™ card form factor and connector are well established. Swissbit's CF cards were developed with strong focus on quality, reliability, robustness, and longevity. We select only high-quality components and apply design rules fitting the stringent requirements of our customers. Hardware and firm-ware were tested and qualified by our experienced technical team and features and functionality have been proven in many challenging customer applications. Swissbit's CF Series C-3x0 and C-4x0 are offered in both commercial (0°C to +70°C) and industrial (-40°C to +85°C) temperature ranges, providing rugged, reliable memory for a wide range of demanding use cases. They are designed to address a broad range of concerns from compatibility, booting, and power fail safety to long-term supply, controlled BOM, and outstanding Flash protocol-handling techniques to ensure highest possible data integrity. In contrast to commonly promoted sequential performance values, Swissbit is especially focused on optimized random-access speed, one of the key requirements in legacy embedded CompactFlash applications.



Swissbit's most recent CF card product family is the C-300 Longevity series, which offers maximum long-term availability (until at least 2021). In addition, the C-300 Longevity CF card ensures optimized backward compatibility with legacy systems, high random access speed, and a wide range of capacities from 32 MB to 8 GB using highly reliable SLC Flash with 100,000 program / erase cycles.

C-300	●	●	●	●	○	●	★	●	○	○	●
C-300 LONGEVITY	●	●	●	★	○	●	★	●	●	○	★
C-320	●	●	●	●	●	●	★	●	●	○	●
C-440	●	●	●	★	●	●	★	●	★	●	●

★ Industry Leading; ● default implemented; ● on request; ○ not available



COMPACTFLASH™ CARD COMPACTFLASH™ CARD COMPACTFLASH™ CARD COMPACTFLASH™ CARD

Series Name	C-300	C-300 Longevity	C-320	C-440
Interface	CFA4.1			CFA5.0
Data Transfer Mode	True IDE/PC card - Up to UDMA4, MDMA4 & PIO6			True IDE/PC card - Up to UDMA6, MDMA4 & PIO6
Connector	CFC Type I			
Outline Dimensions	36.4 x 42.8 x 3.3 mm			
Flash Type	SLC			
Density Range	128 MB to 8 GB	32 MB to 8 GB	2 GB to 32 GB	2 GB to 64 GB
Data Retention	10 years @ life begin 1 year @ life end			
Endurance	100,000 P/E Cycles (Flash Cell Level)			
Operating Temperature	Commercial: 0°C to +70°C Industrial: -40°C to +85°C			
Storage Temperature	-50°C to +100°C			
Performance				
Burst Rate (MB/s)	up to 66	up to 66	up to 66	up to 133
Sequential Read (MB/s)	up to 37	up to 37	up to 45	up to 65
Sequential Write (MB/s)	up to 20	up to 20	up to 35	up to 40
Random 4KB Read (IOPS)	up to 3,300	up to 3,300	up to 2,800	up to 2,400
Random 4KB Write (IOPS)	up to 40	up to 50	up to 44	up to 300 (with TRIM)
MTBF	≥ 3,000,000 hours			
Shock	1,500 G			
Vibration	20 G			
Humidity	85 % RH 85°C, 1,000 hrs			
Voltage	3.3V ± 5% 5V ± 10%			
Power Consumption	PIO typ 50 mA @ 3.3V DMA typ 70 mA @ 3.3V DMA typ 110 mA @ 5V		PIO typ 60 mA @ 3.3V DMA typ 90 mA @ 3.3V DMA typ 130 mA @ 5V	
Features & Tools	Proven Power Fail Safety Sophisticated Wear Leveling & Bad Block management Security & SBZoneProtection features available SBLTM Tool & SDK for S.M.A.R.T. based Life Time Monitoring		Proven Power Fail Safety Sophisticated Wear Leveling & Bad Block management Read Disturb Management TRIM Security & SBZoneProtection features available SBLTM Tool & SDK for S.M.A.R.T. based Life Time Monitoring	
Part Number	SFCxxxxHxBKxss-t-xx-rrr-ccc	SFCxxxxHxBKxss-t-xx-rrr-ccc	SFCxxxxHxB0xss-t-dd-rrr-ccc	SFCxxxxHvBUxss-t-dd-rrr-ccc



FLASH MANAGEMENT MECHANISM

- Optimized error correction code
- Efficient algorithms for bad block management
- Real life time monitoring
- Sophisticated wear leveling and bad block management
- Power fail protection

microSD MEMORY CARDS

Swissbit's Industrial microSD memory cards are designed, manufactured and tested to withstand extreme environmental conditions.

Each of our product series is designed for a broad, embedded use case with its unique requirements for longevity, service life, endurance, temperature, data retention, and cost. In addition to the existing microSD memory card series, Swissbit has recently introduced the S-40u, which targets read-centric applications requiring the highest level of data reliability for long periods of time. The combination of MLC (multi level cell) NAND Flash with innovative controller and firmware technology enables prolonged data retention and extended life cycles despite the write endurance limitations of MLC Flash. The special firmware features in the S-40u include powerful built-in error correction, read retry, autonomous data care management, life time monitoring and diagnostic features, randomizer, wear leveling and bad block management algorithms, and intelligent power fail protection.

The new S-45u (MLC version) and S-450u (SLC version) series include the same set of sophisticated features and, through the implementation of UHS-I, support data transfer rates of up to 80 MB/s.

All Swissbit microSD cards can withstand extreme environmental conditions. They provide the highest level of mechanical stability and enhanced ESD protection. Furthermore, the hard gold SD connectors endure a minimum of 20,000 insertion cycles.

S-300U	●	●	●	○	●	●	●	●	○	●
S-200U	●	●	●	●	●	★	●	○	○	●
S-40U / S-45U	●	●	●	★	●	★	●	★	★	○
S-450U	●	●	●	★	●	★	●	★	★	●

★ Industry Leading; ● default implemented; ○ not available



microSD MEMORY CARD (SD / SDHC)	microSD MEMORY CARD (SD)	microSD MEMORY CARD (SDHC)	microSD MEMORY CARD (SDHC)	microSD MEMORY CARD (SD / SDHC)
--	-----------------------------------	-------------------------------------	-------------------------------------	--

Series Name	S-300µ	S-200µ	S-40µ	S-45µ	S-450µ	
Interface Data Transfer Mode	SD 2.0, Class 6 / 10	SD 2.0, Class 6	SD 3.0, Class 6	SD 3.0, Class 10, UHS-I		
Connector	microSD					
Outline Dimensions	15 x 11 x 0.7 / 1 mm					
Flash Type	SLC		MLC		SLC	
Density Range	1 GB – 2 GB (SD) 4 GB – 8 GB (SDHC)	512 MB – 2 GB (SD)	4 GB – 32 GB (SDHC)		512 MB – 2 GB (SD) 4 GB – 8 GB (SDHC)	
Data Retention	10 years @ life begin 1 year @ life end					
Endurance	100,000 P/E Cycles (Flash Cell Level)		3,000 P/E Cycles (Flash Cell Level)		100,000 P/E Cycles (Flash Cell Level)	
Operating Temperature	Extended: -25°C to +85°C Industrial: -40°C to +85°C					
Storage Temperature	-40°C to +85°C		-40°C to +100°C			
Performance	Burst Rate (MB/s) Sequential Read (MB/s) Sequential Write (MB/s)	up to 25 up to 24 up to 22	up to 25 up to 24 up to 18	up to 25 up to 24 up to 14	up to 104 up to 50 up to 19 Optimized for random write IOPS	up to 104 up to 30 up to 24
MTBF	≥ 3,000,000 hours					
Shock	1,500 G					
Vibration	50 G					
Humidity	93 % RH 40°C, 500 hrs		85 % RH 85°C, 1,000 hrs			
Voltage	2.7 – 3.6 V Normal					
Power Consumption	Read typ 50 mA Write typ 50 mA	Read typ 30 mA Write typ 40 mA	Read typ 40 mA Write typ 60 mA	Read typ 100 mA Write typ 100 mA		
Features & Tools	Proven Power Fail Safety Advanced Wear Leveling & Bad Block management		Proven Power Fail Safety Sophisticated Wear Leveling & Bad Block management Autonomous Data Care Management SBLTM Tool & SDK for detailed Life Time Monitoring			
Part Number	SFSDxxxxlvBWxss-t-dd- rrr-ccc		SFSDxxxxNxBNxss-t-dd- rrr-ccc			

S-45µ: target specification



FLASH MANAGEMENT MECHANISM

- Optimized error correction code
- Efficient algorithms for bad block management
- Diagnostic with real life time monitoring
- Sophisticated wear leveling and bad block management resistance
- Power fail protection

SD MEMORY CARDS

Swissbit's Industrial Secure Digital (SD) card series are designed, manufactured and tested to withstand extreme environmental conditions.

The use of SLC Flash in the S-200 / 220 series combined with an industrial grade Flash controller provide a number of enhanced product features such as built-in error correction, wear leveling and bad block management algorithms, power fail protection, and power saving modes. The housing with special connector support provides resistance against bending and torque.

In addition to the existing SD memory card series, Swissbit has recently introduced the S-40, which targets read-centric applications requiring the highest level of data reliability for long periods of time. The combination of MLC (multi level cell) NAND Flash with innovative controller and firmware technology enable prolonged data retention and extended life cycles despite the write endurance limitations of MLC Flash. The special firmware features in the S-40 include a powerful built-in error correction, read retry, autonomous data care management, life time monitoring and diagnostic features, randomizer, wear leveling and bad block management algorithms and intelligent power fail protection.

The new S-45 (MLC version) and S-450 (SLC version) series include the same set of sophisticated features and, through the implementation of UHS-I, support data transfer rates of up to 80MB/s.

All Swissbit SD cards can withstand extreme environmental conditions. They provide the highest level of mechanical stability and enhanced ESD protection. Furthermore, the hard gold SD connectors endure a minimum of 20,000 insertion cycles.

S-200 / 220	●	●	●	●	○	★	●	○	○	●
S-40 / S-45	●	●	●	★	●	★	●	★	★	○
S-450	●	●	●	★	●	★	●	★	★	●

★ Industry Leading; ● default implemented; ○ not available



SD MEMORY CARD (SD / SDHC) SD MEMORY CARD (SDHC / SDXC) SD MEMORY CARD (SD / SDHC) SD MEMORY CARD (SD / SDHC)

Series Name	S-200 / 220	S-40	S-45	S-450
Interface	SD 2.0, Class 6 / 10	SD 3.0, Class 6	SD 3.0, Class 10, UHS-I	
Data Transfer Mode				
Connector	SD			
Outline Dimensions	32 x 24 x 2.1 mm			
Flash Type	SLC	MLC		SLC
Density Range	512 MB – 2 GB (SD) 4 GB – 8 GB (SDHC)	4 GB – 32 GB (SDHC) 64 GB – 128 GB (SDXC)		512 MB – 2 GB (SD) 4 GB – 32 GB (SDHC)
Data Retention	10 years @ life begin 1 year @ life end			
Endurance	100,000 P/E Cycles (Flash Cell Level)	3,000 P/E Cycles (Flash Cell Level)		100,000 P/E Cycles (Flash Cell Level)
Operating Temperature	Extended: -25°C to +85°C Industrial: -40°C to +85°C			
Storage Temperature	-40°C to +100°C			
Performance	Burst Rate (MB/s) up to 25 Sequential Read (MB/s) up to 21 Sequential Write (MB/s) up to 18	up to 25 up to 24 up to 19	up to 104 up to 50 up to 19 Optimized for random write IOPS	up to 104 up to 90 up to 75
MTBF	≥ 3,000,000 hours			
Shock	1,000 G	1,500 G		
Vibration	15 G	50 G		
Humidity	85 % RH 85°C, 1,000 hrs			
Voltage	2.7 – 3.6 V Normal			
Power Consumption	Read typ 28 mA Write typ 55 mA	Read typ 40 mA Write typ 60 mA	Read typ 100 mA Write typ 100 mA	
Features & Tools	Proven Power Fail Safety Sophisticated Wear Leveling & Bad Block management Diagnostic features & Life Time Monitoring through SD/SPI command set	Proven Power Fail Safety Sophisticated Wear Leveling & Bad Block management Autonomous Data Care Management SBLTM Tool & SDK for detailed Life Time Monitoring		
Part Number	SFSDxxxxlvBNxss-t-dd-rrr-ccc	SFSDxxxxLxBMxss-t-dd-rrr-ccc		

S-45: target specification



USB FLASH DRIVES / MODULES

The Universal Serial Bus (USB) interface is very well established and has almost entirely replaced any other forms of serial or parallel interfaces for computer peripherals and memory storage devices. Advantages of USB are its flexibility, fast sequential data transfer rate, and the ability to obtain power through the connector. Most computer and embedded systems support these devices either via the standard USB connector or internal, on-board terminal headers. Swissbit offers both options in different form factors and in commercial and industrial operating temperature ranges. State of the art NAND Flash handling algorithms, stringent component selection, product change control, and a 100% in-process final system test at full temperature range (-40°C to +85°C) qualify Swissbit's USB Flash Drive (UFDs) for embedded and industrial markets.

Swissbit's U-110 and U-4x Series (USB Flash Module) offers a no compromise Flash based storage solution for:

- embedded PCs that need a rugged reliable storage solution,
- servers with backup or recovery functionality, and
- general industrial computers needing easy-to-use boot media.

All Swissbit USB solutions combine security features and Life Time Monitoring tools for product life control.

U-45	●	○	●	●	●	●	●
U-400	●	○	●	●	●	●	●
U-110	●	○	●	●	●	●	●
unitedCONTRAST II	●	●	●	●	●	●	●

● default implemented; ● on request; ○ not available



	eUSB FLASH MODULE	eUSB FLASH MODULE	eUSB FLASH MODULE	USB FLASH DRIVE
Series Name	U-400	U-45	U-110	unitedCONTRAST II
Interface	USB 2.0			
Data Transfer Mode	High / Full Speed			
Connector	Standard: 2.54 mm – 10 Pin (key option) Low Profile: 2.00 mm – 10 Pin (key option)			USB 2.0 A-Plug
Outline Dimensions	Standard: 36.8 mm x 26.65 mm x 9.6 mm Low Profile: 36.8 mm x 26.65 mm x 5.7 mm			68.0 mm x 18.0 mm x 8.0 mm
Flash Type	SLC	MLC (pSLC mode option)	SLC	SLC
Density Range	1GB to 16 GB (32 GB opt.)	4 GB to 32 GB	1 GB to 16 GB	512 MB to 16 GB
Data Retention	10 years @ life begin 1 year @ life end			
Endurance	100,000 P/E Cycles (Flash Cell Level)	3,000 P/E Cycles (Flash Cell Level)		100,000 P/E Cycles (Flash Cell Level)
Operating Temperature	Commercial: 0°C to +70°C Industrial: -40°C to +85°C			
Storage Temperature	-50°C to +100°C			
Performance				
Burst Rate (MB/s)	up to 60	up to 60	up to 60	up to 60
Sequential Read (MB/s)	up to 37	up to 32	up to 32	up to 32
Sequential Write (MB/s)	up to 26	up to 23	up to 23	up to 23
Random 4KB Read (IOPS)	up to 1,600	up to 650	up to 1,600	up to 1,600
Random 4KB Write (IOPS)	up to 30	up to 650	up to 30	up to 30
MTBF	≥ 3,000,000 hours			
Shock	50 G			
Vibration	15 G			
Humidity	85% RH 85°C, 500 hrs			
Voltage	3.3 V ± 5 % / 5 V ± 10 %		5 V ± 10 % (3.3 V ± 5 % optional)	5 V ± 10 %
Power Consumption	Full Speed typ 90 mA High Speed typ 100 mA			Full Speed typ 80 mA High Speed typ 100 mA
Features & Tools	Proven Power Fail Safety Windows/Linux – Spare block read out Bootable USB Drive Supports latest OS as Fixed Drive Connector pitch variations available Shock & vibration resistant			Proven Power Fail Safety Windows/Linux – Spare block read out Hot Pluggable / Plug & Play Optimized Wear Leveling Security features Password manager available
Part Number	2.54 mm: SFUxxxxlvABxss-t-dd-rrr-ccc 2.00 mm: SFUxxxxlvABxss-t-dd-rrr-ccc		2.54 mm: SFUxxxxlvBPxss-t-dd-rrr-ccc 2.00 mm: SFUxxxxlvBPxss-t-dd-rrr-ccc	SFU2xxxxEvBPxss-t-dd-rrr-ccc

U-4x: target specification

Security is becoming mandatory in diverse markets. Data breaches and compromised IT environments are becoming a reality. Customers and solution providers are rightly concerned about risks, creating a necessity to improve security in a reliable and flexible fashion.



That GSM calls can easily be tapped has been widely publicized in the telecommunications market. Reports about the mass interception of Internet data on a global scale compromise trust in the privacy of communications. Sophisticated attacks on industrial facilities raise questions about liability and reliability. A new class of threats and risks needs consideration. Consumers, governments, enterprises, and industry are affected by security breaches directly or indirectly, visible or invisible.



Swissbit supports its customers in industrial, medical, government, telecommunications, and the banking sector in delivering secure systems.

Each and every system requires storage to operate. While globally recognized as a leader in highly reliable Flash memory solutions, Swissbit also designs, develops, and manufactures security products that provide additional security functions and features. Swissbit demonstrates a continuous, uninterrupted migration path towards secure systems while maintaining the reliability and flexibility of existing memory form factors.



Swissbit offers product related services:

- Security firmware and drivers
- Logo printing
- Optical and electronic personalization
- Design-in of consigned smart card chips

As well as extended services:

- Security consulting
- Security training
- Customer support
- Design-in support
- Connection with eco-system partner network for turn key solutions and quick time to market

SECURITY PRODUCTS - PS-100U SERIES

The security product series in the microSD form factor addresses the growing demand for mobile and portable security. The products offer tangible hardware security in the same manner as the plug and play approach.

For various markets, Swissbit offers a broad set of security use cases. The Flash memory can be used by any host to store data on the cards at high speed. Additional security functions of the card can be activated to protect any data.

Valuable data such as sensitive files, emails, photos, and even voice calls can be protected by encryption, access protection, or made resistant

to tampering by digital signature. The best fitting product can be chosen depending on the use case.

Our PS-100u series provides high security by the optional smart card chip or by the Swissbit security firmware. The block diagram below illustrates the architecture of the Swissbit Security Interface, the Flash Controller, and the Encrypted Flash Chip.

The Swissbit Security Interface empowers solution providers to build applications on various platforms. An SDK is available to develop applications on Windows™ and Linux™ PC platforms and on mobile phones and tablets like Android™ and BlackBerry™.

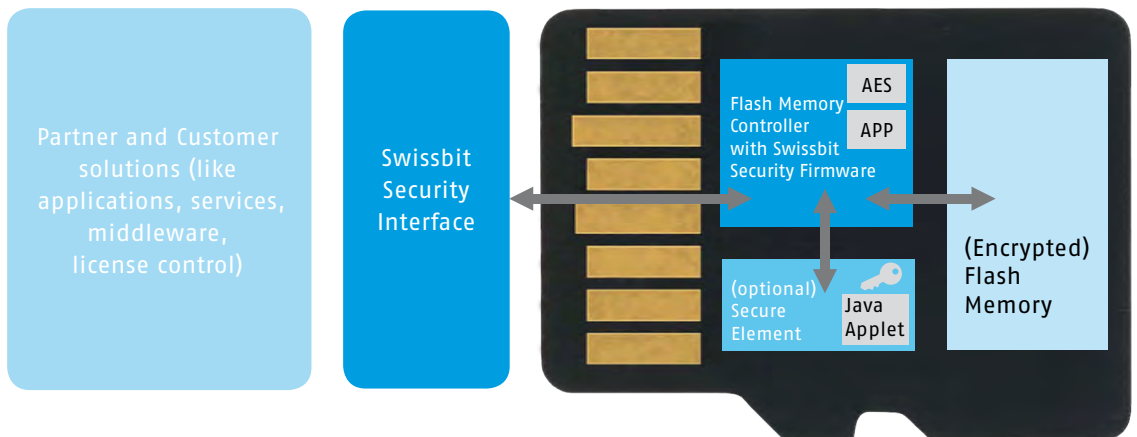

SECURITY PRODUCTS

	PS-100u SE/VE/PE	PS-100u FE
Compliance	SD 3.0 SD, ASSD V1.1	SD 3.0 SD, ASSD V1.1
Data transfer	SPI mode supported Speed class 10	SPI mode supported Speed class 10
Density	4 GB / 8 GB / 16 GB	8 GB / 16 GB
Temperature	Extended: -25°C to +85°C	Extended: -25°C to +85°C
Security	<p>Infineon SLE 78 smart card chip CC EAL 5+ HW and OS Java card 3.0.4 Global Platform 2.2.1 Smart card OS jTop ID</p> <p>RSA up to 2048 bit optional ECC up to 512 / 521 bit AES up to 256 bit SHA2 up to 512 bit RNG AIS31, FIPS-140</p> <p>Compatible Middleware: • AET SafeSign • Charismathics • Cryptovision</p>	<p>Infineon SLE 78 smart card chip FIPS 140-2 level 3 Java card V2.2.x (ext. of V3.0) Global Platform 2.2.1 Gemalto ID Core 30</p> <p>RSA up to 2048 bit ECC up to 512 / 521 bit AES up to 256 bit SHA2 up to 512 bit</p> <p>Compatible Middleware: • Gemalto</p>
	80 k EEPROM secure storage	160 k EEPROM secure storage
Drivers / API	WinXP, 7, 8, Vista, Linux, BlackBerry, Android SDK available	WinXP, 7, 8, Vista, Linux, BlackBerry, Android SDK available



SECURITY



The Standard Edition PS-100u SE fits best into authentication and PKI (Public Key Information) use cases.

The card is supported by leading middleware vendors in mobile, desktop, and tablet use cases to ensure a seamless design-in into existing security infrastructures.

Typical applications are:

- mobile email encryption,
- digital signature,
- user authentication for PC and mobile login, and
- true random number generation.



The Voice Edition PS-100u VE provides Elliptic Curve Cryptography. The enormous advantage of computation and security combined with small certificate sizes makes the PS-100u VE card ideal for online key and certificate exchange.

Solution providers choose the PS-100u VE card to build secure mobile voice solutions. The users (caller and person called) only need to enter their PIN into their mobile device and the security chip performs end-to-end encryption on their behalf. All encryption keys for authentication and key agreements remain highly protected in the card at all times. Only AES key stream segments suitable for voice stream encryption are passed to the mobile host application.

The PS-100u VE extends the features of the PS-100u SE.



The PS-100u DP and PS-100u PE cards provide Flash memory encryption, secure logging, and flexible CD-ROM storage.

The PS-100u PE offers asymmetric and symmetric cryptography by the embedded smart card, whereas the PS-100u DP offers symmetric encryption without smart card.



The PS-100u FE provides a secure element according FIPS 140-2 certification. US governmental organizations and enterprises that need to follow the FIPS 140-2 security standard now benefit from smart integration into the microSD form factor.

PS-100u SE	●	●	●	●	●	○	○	○	○	○
PS-100u VE	●	●	●	●	●	●	●	○	○	○
PS-100u FE	●	●	●	●	●	●	●	○	○	○
PS-100u PE	●	●	●	●	●	●	●	●	●	●
PS-100u DP	○	○	○	○	○	○	○	●	●	●

● supported; ○ not available;

MEMORY SOLUTIONS

Swissbit commits to offering the highest quality, JEDEC standard and customized DRAM modules for industrial applications. As a DRAM module manufacturer, we use strategic multiple sources of DRAM suppliers to offer our customers a reliable, long-term supply of leading edge and legacy memory module products. Special focus is put into working with suppliers that offer extended availability of DRAM die revisions, avoiding frequent requalification efforts with our customers.

Swissbit's quality focus starts with sourcing the highest quality DRAMs and utilizing fully compliant JEDEC module raw cards either as in-house PCB design or from top quality design partners. For all modules, the passives and other active components selected are of the highest available quality. Using surface mount technology (SMT) processes in production on fully certified facilities in Germany allows Swissbit to sustain a quality focus during the entire assembly process. Traceability is guaranteed through the complete manufacturing and testing flow. We ensure the highest quality level for our customers with world class application testing. Swissbit uses in-house developed application software to test 100% of all modules under real-world conditions with diverse pattern and stress methods and to cover the complete memory array including ECC components by constantly adapting to the latest memory controller features. For industrial temperature grade modules the application tests are performed at -40°C and $+85^{\circ}\text{C T}_{\text{AMBIENT}}$.

With a stringent internal product qualification, fast customer return processing and the dedication to always be an improving company, Swissbit constantly works on providing its customers the best DRAM modules available on the market at a competitive price. Swissbit is committed and able to design, manufacture, and test customer-specific module solutions. We offer PCB design and layout services, development of individual test solutions, thermal simulations, DRAM component sourcing, controlled manufacturing, and special coating options.

By using Swissbit DRAM modules, you can keep the total system cost to a minimum.



DRAM SPECIFIC OPTIONS



DDR1 DIMM/RDIMM	●	○	○	○	○	
DDR1 SODIMM/SO-RDIMM	●	○	○	○	○	
DDR2 DIMM/RDIMM	●	○	○	○	○	
DDR2 SODIMM	●	○	○	●	○	
DDR3 DIMM	●	○	○	○	●	
DDR3 RDIMM	●	○	●	●	●	
DDR3 MINIDIMM	●	○	●	●	●	
DDR3 SODIMM/SO-UDIMM	●	○	●	●	●	●
DDR3 XR-DIMM	●	●	●	○	●	

● default implemented; ● on request; ○ not available

DDR4, FASTER AT LOW POWER

With its architectural features and the subsequent extension to 1.35V, DDR3 technology had the widest range of data rates. But the end of DDR3 technology's evolution has finally come. Further improvements were necessary to open a path for even higher data rates. The new JEDEC standard, DDR4 addresses, these requirements. Its spec targets a doubling of the data rate from today's DDR3-1600 to a blazing DDR4-3200. The introduction of DDR4 already starts at 2133 Mb/s and offers a 30% higher bandwidth compared to main stream DDR3L speed.

At the same time, the operating voltage could be reduced from 1.35V to 1.20V. Together with several new power saving features like an improved termination scheme, data bus inversion, and grouping of banks, the total power

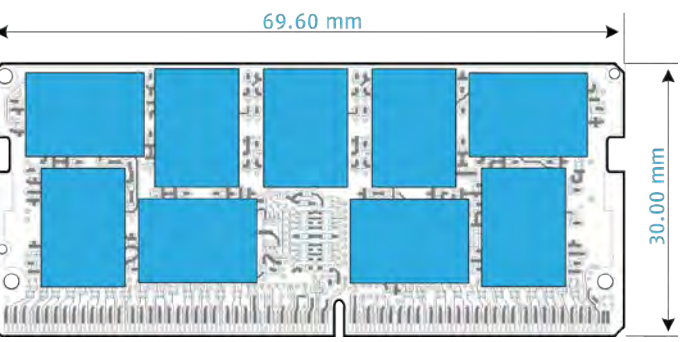

consumption and heat dissipation has been significantly reduced vis-à-vis DDR3L. The DDR4 standard also adds reliability features like CRC and command / address bus parity.

DDR4 has been fully standardized at JEDEC and the most recent memory controllers support it.

Swissbit will offer a complete portfolio of DDR4 modules as JEDEC releases them, focusing on the form factors that are most important to the industrial market, beginning with ECC SODIMMs.



RUGGEDIZED DIMMS



Designers of rugged platforms face a difficult decision when planning their memory layout: either they use DRAM components directly soldered to the system board, the most rugged but also expensive and inflexible solution, or they try to ruggedize standard SODIMMs by using straps or glue to fasten them in their sockets.

In cooperation with the SFF-SIG consortium (Small Form Factor-Special Interest Group), Swissbit has developed a rugged module called XR-DIMM™, the abbreviation XR standing for eXtreme Rugged.

Using special mezzanine connectors and mounting holes to attach the module to the system board creates a truly rugged system with the easy integration and flexibility of DIMM solutions and the shock and vibration immunity of memory down implementations.

The XR-DIMM closely follows the DDR3 72 bit SODIMM standard and makes design-in as easy as using a JEDEC module, unburdening the system designer from memory channel layout.

With multiple module densities, the system integrator can create different memory populations with one system platform, avoiding multiple system board SKUs and taking advantage of perfectly tested modules with a just-in-time purchase option.



DESIGN-IN/LAYOUT

FLEXIBILITY OF MEMORY POPULATION

TESTABILITY AFTER SOLDERING

UPGRADE/REPAIR

REQUIRED BOARD SPACE

STACKABLE SOLUTION

PROTECTION AGAINST SHOCK

PROTECTION AGAINST VIBRATION

MEMORY COST

	Memory down	SODIMM with fixture	XR-DIMM
DESIGN-IN/LAYOUT	Difficult	Easy	Easy
FLEXIBILITY OF MEMORY POPULATION	Difficult	Easy	Easy
TESTABILITY AFTER SOLDERING	Medium	Easy	Easy
UPGRADE/REPAIR	Difficult	Easy	Easy
REQUIRED BOARD SPACE	Small to Medium	Medium to Small	Medium to Small
STACKABLE SOLUTION	No	Yes	Yes
PROTECTION AGAINST SHOCK	Good	Medium (with glue/strap)	Good
PROTECTION AGAINST VIBRATION	Good	Bad	Good
MEMORY COST	Low to Medium	Low	Medium

UNBUFFERED DIMM PRODUCTS

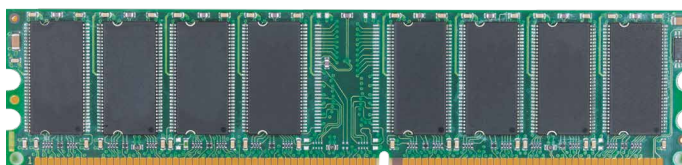

LONG UDIMM/WITH AND WITHOUT ECC

	Data Rate / CL	Density	Org	Height	Voltage	Pins	Partnumber	Package
DDR4-UDIMM	2133 / CL15	4 GB – 16 GB	x64	31.25 mm	1.20 V	260	SHUxxx64xxxxxxxx-ssR	BGA
DDR3L-UDIMM	1600 / CL11	2 GB – 8 GB	x64	1.18" (29.97 mm)	1.35 / 1.50 V	240	SLUxxx64xxxxxxxx-ssR	BGA
DDR3L-UDIMM ECC	1600 / CL11	2 GB – 8 GB	x72	1.18" (29.97 mm)	1.35 / 1.50 V	240	SLUxxx72xxxxxxxx-ssR	BGA
DDR2-UDIMM	800 / CL6	512 MB – 2 GB	x64	1.18" (29.97 mm)	1.80 V	240	SEUxxx64xxxxxxxx-ssR	BGA
DDR2-UDIMM ECC	800 / CL6	1 GB – 2 GB	x72	1.18" (29.97 mm)	1.80 V	240	SEUxxx72xxxxxxxx-ssR	BGA
DDR1-UDIMM	400 / CL3	512 MB – 1 GB	x64	1.25" (31.75 mm)	2.50 V	184	SDUxxx64xxxxxxxx-ssR	TSOP
DDR1-UDIMM ECC	400 / CL3	512 MB – 1 GB	x72	1.25" (31.75 mm)	2.50 V	184	SDUxxx72xxxxxxxx-ssR	TSOP



SODIMM/WITH AND WITHOUT ECC/RUGGED XR-DIMM

	Data Rate / CL	Density	Org	Height	Voltage	Pins	Partnumber	Package
DDR4-SODIMM	2133 / CL15	4 GB – 16 GB	x64	30 mm	1.20 V	260	SHNxxx64xxxxxxxx-ssRT	BGA
DDR4-SODIMM ECC	2133 / CL15	4 GB – 16 GB	x72	30 mm	1.20 V	260	SHNxxx72xxxxxxxx-ssRT	BGA
DDR3L-SODIMM	1600 / CL11	1 GB – 8 GB	x64	1.18" (29.97 mm)	1.35 / 1.50 V	204	SLNxxx64xxxxxxxx-ssRT	BGA
DDR3L-SO-UDIMM	1600 / CL11	2 GB – 8 GB	x72	1.18" (29.97 mm)	1.35 / 1.50 V	204	SLNxxx72xxxxxxxx-ssRT	BGA
DDR3-SODIMM	1600 / CL11	1 GB – 8 GB	x64	1.18" (29.97 mm)	1.50 V	204	SGNxxx64xxxxxxxx-ssRT	BGA
DDR3-SO-UDIMM	1600 / CL11	1 GB – 8 GB	x72	1.18" (29.97 mm)	1.50 V	204	SGNxxx72xxxxxxxx-ssRT	BGA
DDR3-XR-DIMM™	1600 / CL11	1 GB – 8 GB	x72	38 mm x 67,5 mm	1.35 / 1.50 V	240	SLVxxx72xxxxxxxx-ssRT	BGA
DDR2-SODIMM	800 / CL6	512 MB – 4 GB	x64	1.18" (29.97 mm)	1.80 V	200	SENxxx64xxxxxxxx-ssR	BGA
DDR1-SODIMM	400 / CL3	256 MB – 1 GB	x64	1.25" (31.75 mm)	2.50 V	200	SDNxxx64xxxxxxxx-ssR	BGA



MINI-UDIMM / 100PIN-DIMM

	Data Rate / CL	Density	Org	Height	Voltage	Pins	Partnumber	Package
DDR3-MiniUDIMM	1600 / CL11	2 GB – 8 GB	x72	1.18" / 0.74"	1.50 V	244	SGLxxx72xxxxxxxx-ssRT	BGA
DDR1-100PIN_DIMM	333 / CL2.5	128 MB – 512 MB	x72	1.00" (25.40 mm)	2.50 V	100	SDUxxx32xxxxxxxx-ssR	TSOP

MODULE OPTIONS

HEAT SPREADER



The critical condition for DRAMs is a high die temperature, because it leads to loss of cell information. With die sizes continually shrinking, power dissipation is concentrated on only a few square millimeters. Adding a heat spreader to a module allows the hot spots to more easily dissipate the heat over a bigger surface. This heat spreader levels out the module's heat dissipation, thus reducing the hot-spot temperature and improving the module's reliability.

Swissbit offers heat-spreader solutions for some of its industrial temperature grade SODIMMs and MiniDIMMs.

CONFORMAL COATING



Industrial DRAM modules often do not operate in a clean air environment relative to standard office or home conditions. A heavy-industry environment with hot or humid air, aggressive chloride of sulfite loaded gas or dust can reduce the life span of a DRAM module by corroding the PCB lines or solder contacts.

Swissbit offers a full module surface coating with a thin film of polyurethane, which effectively protects against most hazardous environmental conditions. The module's endurance is greatly improved with this protection, thus reducing maintenance periods and avoiding sudden breakdown of a system. This option is currently available for SODIMMs as well as for several Flash products.

CORROSION RESISTANCE



For demanding applications Swissbit uses a thick, 30 micro-inch layer of gold on the DIMM contacts and special sulfur corrosion resistant passives to offer the highest reliability and longest lifetime.



UNPROTECTED PCB AFTER HIGHLY ACCELERATED CORROSION TEST

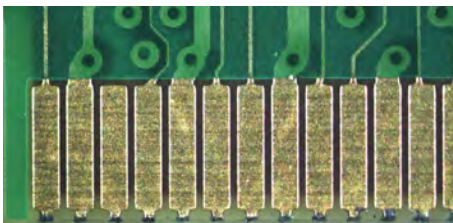

SWISSBIT PROTECTED PCB AFTER HIGHLY ACCELERATED CORROSION TEST

TEMPERATURE SENSOR



For all DDR3 SODIMMs, MiniDIMMs, and registered DIMMs, Swissbit offers an integrated temperature sensor by default within the SPD device. It allows permanent monitoring of the module temperature over the system management bus. By utilizing this feature, system management can actually control the module's self-heating in a more accurate manner than by using calculation methods for memory throttling. This results in greater useable bandwidth and avoids overheating of the module.

INDUSTRIAL TEMPERATURE RANGE



Besides modules for commercial temperature range 0°C to +70°C, Swissbit also offers products for an extended temperature range of 0°C to +85°C T_{AMBIENT} as well as the full industrial temperature range -40°C to +85°C T_{AMBIENT}. With intensive application testing of each individual module at low and high temperature, Swissbit ensures the highest quality and reliability of their products.

REGISTERED DIMM PRODUCTS



LONG RDIMM / STANDARD HEIGHT / WITH ECC AND C/A PARITY

	Data Rate / CL	Density	Org	Height	Voltage	Pins	Partnumber	Package
DDR3L-RDIMM ECC+PARITY	1600 / CL11	4 GB - 8 GB	x72	1.18" (29.97 mm)	1.35 V	240	SLPxxx72xxxxxx-ssR	BGA
DDR3-RDIMM ECC+PARITY	1333 / CL9	1 GB - 8 GB	x72	1.18" (29.97 mm)	1.50 V	240	SGPxxx72xxxxxx-ssR	BGA
DDR2-RDIMM ECC+PARITY	800 / CL6	1 GB - 4 GB	x72	1.18" (29.97 mm)	1.80 V	240	SEPxxx72xxxxxx-ssR	BGA



LOW PROFILE LONG RDIMM, UDIMM / WITH ECC

	Data Rate / CL	Density	Org	Height	Voltage	Pins	Partnumber	Package
DDR3-RDIMM ECC+PARITY	1333 / CL9	2 GB - 8 GB	x72	0.70" (17.78 mm)	1.50 V	240	SGPxxx72xxxxxx-ssR	BGA
DDR3L-UDIMM ECC	1600 / CL11	2 GB - 8 GB	x72	0.74" (18.90 mm)	1.35 V	240	SLUxxx72xxxxxx-ssR	BGA
DDR3-UDIMM ECC	1333 / CL9	2 GB - 4 GB	x72	0.70" (17.78 mm)	1.50 V	240	SGUxxx72xxxxxx-ssR	BGA
DDR2-RDIMM ECC+PARITY	800 / CL6	1 GB - 2 GB	x72	0.72" (18.29 mm)	1.80 V	240	SEPxxx72xxxxxx-ssR	BGA



VLP MINIRDIMM WITH ECC, REGISTERED SO-RDIMM WITH ECC

	Data Rate / CL	Density	Org	Height	Voltage	Pins	Partnumber	Package
DDR3-MiniRDIMM	1333 / CL9	2 GB - 4 GB	x72	0.72" (18.29 mm)	1.50 V	244	SGHxxx72xxxxxx-ssR	BGA
DDR2-MiniRDIMM	667 / CL5	1 GB	x72	0.72" (18.29 mm)	1.80 V	244	SEHxxx72xxxxxx-ssR	BGA
DDR2-SO-RDIMM	667 / CL5	1 GB - 2 GB	x72	1.18" (29.97 mm)	1.80 V	200	SEGxxx72xxxxxx-ssR	BGA

SYSTEM-IN-PACKAGE (SiP)



System-in-Package (SiP) is the processing of sensitive bare dies or chips into robust finished modules or components. With 20 years of experience, Swissbit successfully uses advanced packaging technologies to achieve the smallest form factors and to build multi-chip-packages. With this electronic integration approach, our products provide more functionality or highest memory densities inside one package, various functional blocks (RF, digital, sensors, security, and memory) as well as passive components are combined.

Beginning with the wafer and bare die handling, Swissbit utilizes a flexible chip-on-board (COB) assembly and packaging line. Processes like SMT assembly, die bonding, Au and Al wire bonding, dam&fill, transfer molding, precise separation with laser technology and sawing, housing, labeling, laser marking, etc. are very well established.

Die stacking, especially for Flash and DRAM, is one of our expertises besides the integration of additional hardware features and an experienced team of testing and quality engineers. Our own Memory-In-Package line qualifies (but does not limit) Swissbit as the development and production partner for any dedicated or customized memory-related product with challenging integration or reliability requirements. If you cannot satisfy the special demands regarding space and performance using traditional components and processes, Swissbit offers feasibility studies, manages or supports your development project, and produces prototypes and small and mid-size volumes (up to 50,000 pieces /month). We will aid you beginning at your project's conception: from the design phase, prototyping, determining the circuit layout, and material selection to preparing the appropriate packaging for transport.

Swissbit produces and develops according to **ISO 9001:2008**, **TS 16949**, and **ISO 14001** approved processes and is an experienced partner in global industrial and automotive accounts.

Swissbit's technology portfolio combined with its strong engineering know-how and experience enables new, innovative MCP (Multi Chip Packages)/SiP/COB configurations like stacked dies, side-by-side, sensors integration, etc. System-in-Package solutions could be smaller, cheaper, and having tighter security.

System-in-Package benefits:

- Reduced process complexity
- Lower TCO (total cost of ownership)
- Reduced system board space due to smaller sized solutions than individually packaged ICs
- Layer count reduction in System PCB
- Reduced board mounted height
- Mixed analog/digital design
- Reduced system board test complexity

SWISSBIT SIP AND COB COMPETENCY



- Product definition
- Feasibility studies
- Verification plan
- Qualification plan
- Design for test
- Design for production
- Design to cost

- Package development
- Process development
- Substrate layout
- Test engineering and development
- Failure analysis consulting

- Product verification
- Debugging
- Optimization
- Reliability testing
- Life time
- Compliance to CE / FCC / VCCI, UL, RoHS, and REACH

- Fast prototyping
- Ramp up
- Yield management
- Series production of:
 - SMT
 - SiP
 - COB
 - MCP
 - BGA

- Stock management
- Supply chain management
- One-stop sourcing

SWISSBIT IS OFFERING THE FOLLOWING PRODUCTION TECHNOLOGIES



SMD



SEPARATION/
SINGULATION



DIE ATTACH/CHIP BONDING/
DIE STACKING



WIRE BONDING



ENCAPSULATION



ADHESIVE APPLY



MARKING



CONFORMAL
COATING

Flash and Security Part Number Decoder



Swissbit Memory (1)

Memory Type (2)

F: Flash Products

Product Type (3)

- U2: USB 2.0 Flash Drive
- CA: CFast™
- CF: CompactFlash™
- PC: PCIe
- UI: UFD internal/Module
- SD: SD memory card
- MM: Multimedia card
- PA: PATA/IDE
- SA: SATA

Density (4)

0016: 16 MB	4096: 4 GB	030G: 30 GB
0032: 32 MB	8192: 8 GB	060G: 60 GB
0064: 64 MB	016G: 16 GB	120G: 120 GB
0128: 128 MB	032G: 32 GB	240G: 240 GB
0256: 256 MB	064G: 64 GB	480G: 480 GB
0512: 512 MB	128G: 128 GB	960G: 960 GB
1024: 1 GB	256G: 256 GB	
2048: 2 GB	512G: 512 GB	

Product Dimension (5)

- H: CompactFlash™ / CFast™
- J: UFD Module 2.54 mm terminal header
- K: UFD Module 2.00 mm terminal header
- L: SD memory card
- M: M.2 SSD
- N: microSD memory card
- O: Multimedia card
- Q: SSD 2.5"
- U: mSATA (MO-300)
- V: SLIM SATA (MO-297)

Product Generation (6)

Memory Organization (7)

TecÚology (8)

Design Option (15)

Configuration (14)

PIN Mode (13)

- Q: 1 nCE & R/nB
- 1: 2 nCE & R/nB
- 2: 4 nCE & R/nB
- A: LGA 1 nCE & R/nB
- B: LGA 2 nCE & R/nB
- C: LGA 4 nCE & R/nB
- E: COB 1 nCE
- F: COB 2 nCE
- G: COB 4 nCE & R/nB
- H: COB 8 nCE & R/nB
- O: 2 TSOP, single channel, 1 nCE & R/nB
- P: 2 TSOP, single channel, 2 nCE & R/nB
- Q: 2 TSOP, single channel, 4 nCE & R/nB
- S: TSOP 1 nCE & R/nB
- T: TSOP 2 nCE & R/nB
- U: TSOP 4 nCE & R/nB

Flash Package Classification (12)

- M: SLC SDP (single die package)
- D: SLC DDP (dual die package)
- Q: SLC GDP (quad die package)
- N: SLC ODP (octal die package)
- G: MLC SDP (single die package)
- L: MLC DDP (dual die package)
- H: MLC GDP (quad die package)
- O: MLC ODP (octal die package)

Temperature Rating (11)

- I: Industrial Temp. (-40°C to +85°C)
- E: Extended Temp. (-25°C to +85/90°C)
- C: Commercial Temp. (0°C to +70°C)

Flash Supplier (10)

- SA: Samsung
- MT: Micron Technology
- HY: SK Hynix
- TO: Toshiba
- MA: Macronix
- AP: Spansion

Chips / Channels (9)

DRAM Part Number Decoder

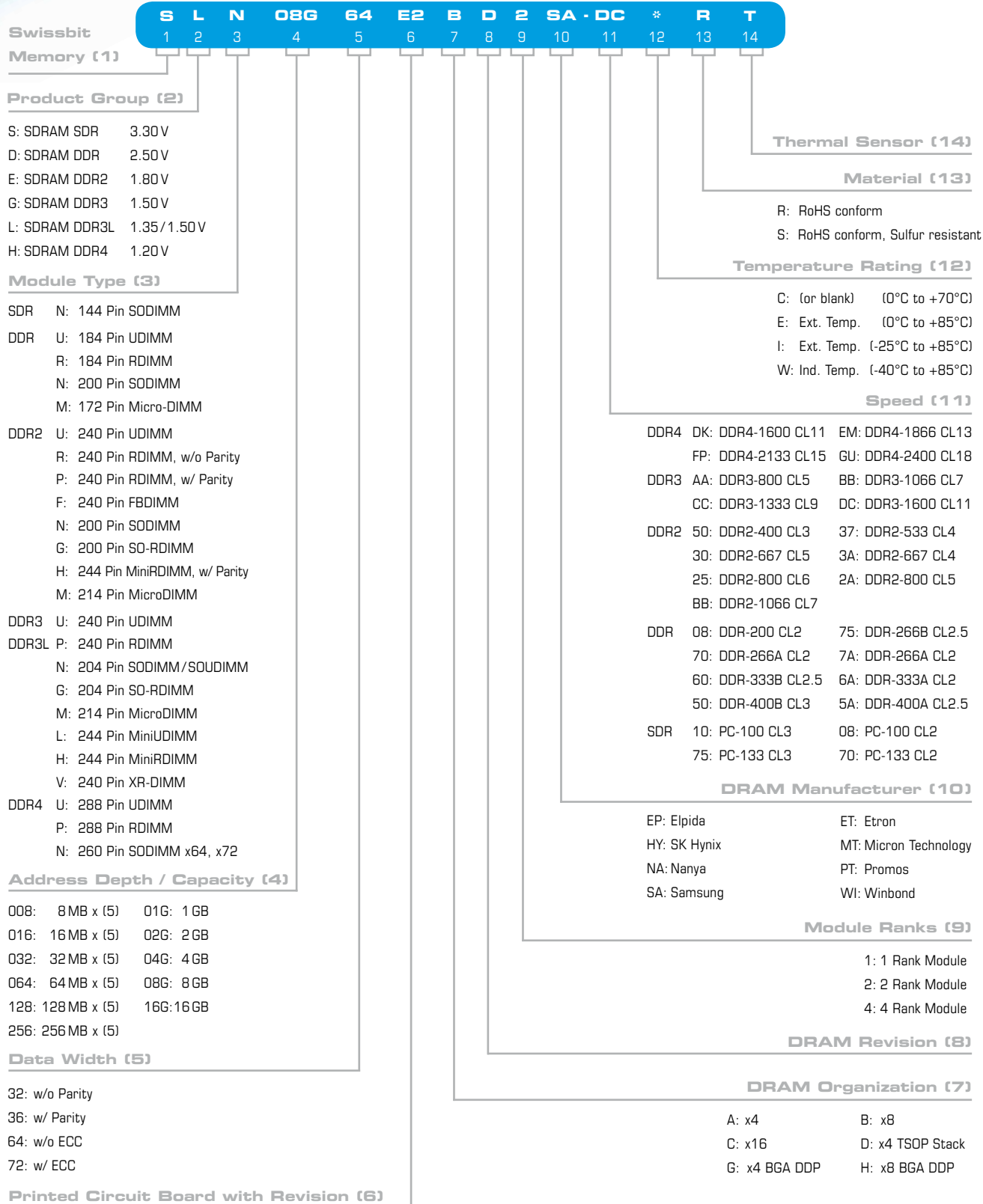

Swissbit NA Eagle, ID
FAE support + Sales
1117 E Plaza Dr,
Eagle, ID 83616, USA
sales@swissbitna.com



Swissbit Germany
R&D + Production
Wolfener Straße 36,
12681 Berlin, Germany
industrial@swissbit.com



Swissbit NA Orange County, CA
FAE support
29222 Rancho Viejo Rd,
San Juan Capistrano, CA 92675, USA
sales@swissbitna.com

Swissbit NA Westford, MA
R&D + FAE support
238 Littleton Rd #202b,
Westford, MA 01886, USA
sales@swissbitna.com



Swissbit Japan
FAE support + Sales
2-1-24 Koenji-Kita,
Suginami-Ku Tokyo 166-0002,
Japan
industrial@swissbit.co.jp



Swissbit NA Port Chester, NY
HQ SBNA + Sales
18 Williett Ave #202,
Port Chester, NY 10573, USA
sales@swissbitna.com

Swissbit Germany
Design Center
Dresden, Germany
industrial@swissbit.com



Swissbit Taiwan
R&D, FAE support, Sales
2F., No. 125, Shengli 2nd Rd,
Zhubei City, Hsinchu County 302,
Taiwan (R.O.C.)
salesasia@swissbit.com



Swissbit AG
Headquarters, R&D,
FAE support, Sales
Industriestraße 4,
9552 Bronschhofen, Switzerland
industrial@swissbit.com





Swissbit Security
R&D, FAE support, Sales
Kirchenstraße 62,
81675 Munich, Germany
security@swissbit.com



Looking for pricing, stock, or lifecycle information?

Click below to explore more details on WIN SOURCE:

-  [View SLN02G72F1BF1SA-DCWRT-KD2 on WIN SOURCE](#)
-  [Swissbit NA Inc. Information](#)

Optimize Your Supply Chain with WIN SOURCE Solutions

-  Global Sourcing Solution
-  Obsolete Management
-  Cost Control Management
-  Shortage Management
-  Alternative Solution
-  Excess Inventory Management