



**THE DATASHEET OF
CY62147EV30LL-45BVXA**



Features

- Very high speed: 45 ns
- Temperature ranges
 - Automotive-A: -40 °C to +85 °C
 - Automotive-E: -40 °C to +125 °C
- Wide voltage range: 2.20 V to 3.60 V
- Pin compatible with CY62147DV30
- Ultra low standby power
 - Typical standby current: 1 μA
 - Maximum standby current: 7 μA (Automotive-A)
- Ultra low active power
 - Typical active current: 2 mA (Automotive-A) at f = 1 MHz
- Easy memory expansion with \overline{CE} [1] and \overline{OE} features
- Automatic power down when deselected
- Complementary metal oxide semiconductor (CMOS) for optimum speed and power
- Available in Pb-free 48-ball very fine ball grid array (VFBGA) (single/dual CE option) and 44-pin thin small outline package (TSOP) II packages
- Byte power-down feature

Functional Description

The CY62147EV30 is a high-performance CMOS static RAM (SRAM) organized as 256K words by 16 bits. This device features advanced circuit design to provide ultra low active

current. It is ideal for providing More Battery Life™ (MoBL®) in portable applications such as cellular telephones. The device also has an automatic power down feature that significantly reduces power consumption when addresses are not toggling. Placing the device in standby mode reduces power consumption by more than 99 percent when deselected (\overline{CE} HIGH or both \overline{BLE} and \overline{BHE} are HIGH). The input and output pins (I/O₀ through I/O₁₅) are placed in a high-impedance state when:

- Deselected (\overline{CE} HIGH)
- Outputs are disabled (\overline{OE} HIGH)
- Both Byte High Enable and Byte Low Enable are disabled (\overline{BHE} , \overline{BLE} HIGH)
- Write operation is active (\overline{CE} LOW and \overline{WE} LOW)

To write to the device, take Chip Enable (\overline{CE}) and Write Enable (\overline{WE}) inputs LOW. If Byte Low Enable (\overline{BLE}) is LOW, then data from I/O pins (I/O₀ through I/O₇) is written into the location specified on the address pins (A₀ through A₁₇). If Byte High Enable (\overline{BHE}) is LOW, then data from I/O pins (I/O₈ through I/O₁₅) is written into the location specified on the address pins (A₀ through A₁₇).

To read from the device, take Chip Enable (\overline{CE}) and Output Enable (\overline{OE}) LOW while forcing the Write Enable (\overline{WE}) HIGH. If Byte Low Enable (\overline{BLE}) is LOW, then data from the memory location specified by the address pins appear on I/O₀ to I/O₇. If Byte High Enable (\overline{BHE}) is LOW, then data from memory appears on I/O₈ to I/O₁₅. See the Truth Table on page 12 for a complete description of read and write modes.

For a complete list of related resources, [click here](#).

Logic Block Diagram

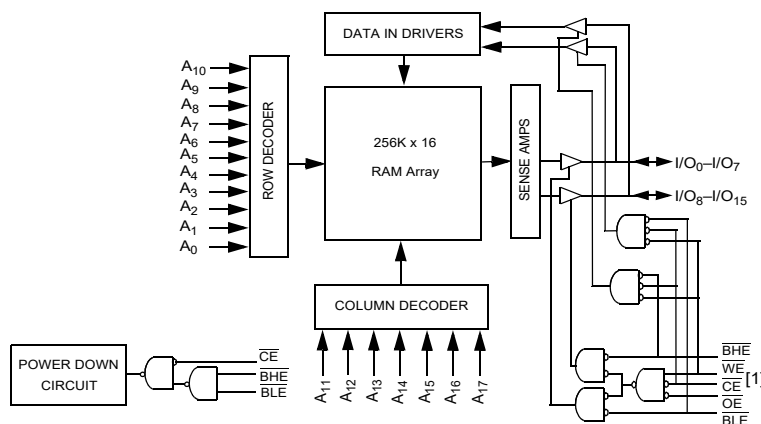

Note

1. BGA packaged device is offered in single CE and dual CE options. In this data sheet, for a dual CE device, \overline{CE} refers to the internal logical combination of \overline{CE}_1 and \overline{CE}_2 such that when \overline{CE}_1 is LOW and \overline{CE}_2 is HIGH, \overline{CE} is LOW. For all other cases \overline{CE} is HIGH.

Contents

Product Portfolio	3	Ordering Information	13
Pin Configurations	4	Ordering Code Definitions	13
Maximum Ratings	5	Package Diagrams	14
Operating Range	5	Acronyms	16
Electrical Characteristics	5	Document Conventions	16
Capacitance	6	Units of Measure	16
Thermal Resistance	6	Document History Page	17
AC Test Load and Waveforms	6	Sales, Solutions, and Legal Information	18
Data Retention Characteristics	7	Worldwide Sales and Design Support	18
Data Retention Waveform	7	Products	18
Switching Characteristics	8	PSoC® Solutions	18
Switching Waveforms	9	Cypress Developer Community	18
Truth Table	12	Technical Support	18

Product Portfolio

Product	Range	V _{CC} Range (V)			Speed (ns)	Power Dissipation					
						Operating I _{CC} (mA)				Standby I _{SB2} (μA)	
		f = 1 MHz		f = f _{max}							
		Min	Typ ^[2]	Max		Typ ^[2]	Max	Typ ^[2]	Max	Typ ^[2]	Max
CY62147EV30LL	Automotive-A	2.2	3.0	3.6	45 ns	2	2.5	15	20	1	7
	Automotive-E	2.2	3.0	3.6	55 ns	2	3	15	25	1	20

Note

2. Typical values are included for reference only and are not guaranteed or tested. Typical values are measured at V_{CC} = V_{CC(typ)}, T_A = 25 °C.

Pin Configurations

Figure 1. 48-Ball VFBGA Pinout (Single Chip Enable) ^[3, 4]

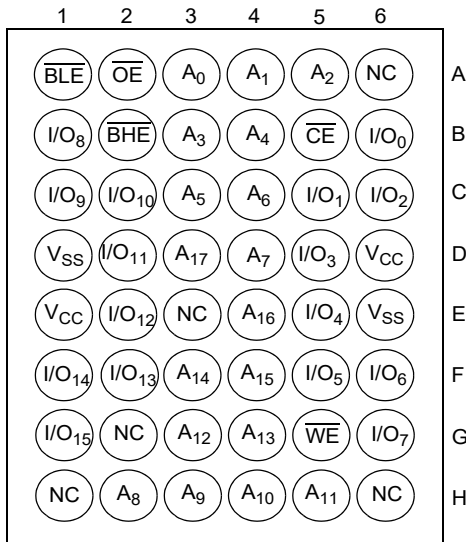

Figure 2. 48-Ball VFBGA Pinout (Dual Chip Enable) ^[3, 4]

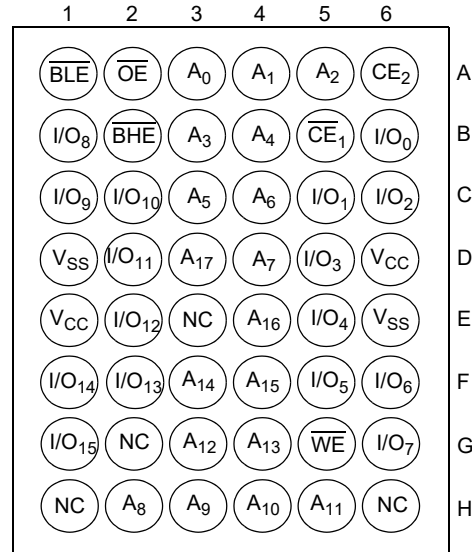
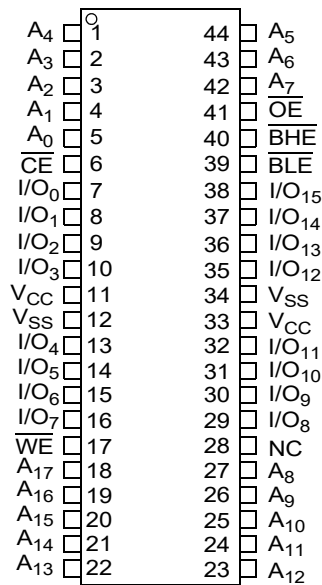

Figure 3. 44-Pin TSOP II Pinout ^[3]



Notes

- 3. NC pins are not connected on the die.
- 4. Pins H1, G2, and H6 in the BGA package are address expansion pins for 8Mb, 16Mb, and 32Mb, respectively.

Maximum Ratings

Exceeding the maximum ratings may impair the useful life of the device. User guidelines are not tested.

Storage temperature -65 °C to + 150 °C

Ambient temperature with power applied -55 °C to + 125 °C

Supply voltage to ground potential -0.3 V to + 3.9 V ($V_{CCmax} + 0.3$ V)

DC voltage applied to outputs in High Z state ^[5, 6] -0.3 V to 3.9 V ($V_{CCmax} + 0.3$ V)

DC input voltage ^[5, 6] -0.3 V to 3.9 V ($V_{CCmax} + 0.3$ V)

Output current into outputs (LOW) 20 mA

Static discharge voltage (MIL-STD-883, method 3015) >2001 V

Latch-up current >200 mA

Operating Range

Device	Range	Ambient Temperature	V _{CC} ^[7]
CY62147EV30LL	Automotive-A	-40 °C to +85 °C	2.2 V to 3.6 V
	Automotive-E	-40 °C to +125 °C	

Electrical Characteristics

Over the Operating Range

Parameter	Description	Test Conditions	45 ns (Automotive-A)			55 ns (Automotive-E)			Unit
			Min	Typ ^[8]	Max	Min	Typ ^[8]	Max	
V _{OH}	Output HIGH voltage	I _{OH} = -0.1 mA	2.0	-	-	2.0	-	-	V
		I _{OH} = -1.0 mA, V _{CC} ≥ 2.70 V	2.4	-	-	2.4	-	-	V
V _{OL}	Output LOW voltage	I _{OL} = 0.1 mA	-	-	0.4	-	-	0.4	V
		I _{OL} = 2.1 mA, V _{CC} = 2.70 V	-	-	0.4	-	-	0.4	V
V _{IH}	Input HIGH voltage	V _{CC} = 2.2 V to 2.7 V	1.8	-	V _{CC} + 0.3	1.8	-	V _{CC} + 0.3	V
		V _{CC} = 2.7 V to 3.6 V	2.2	-	V _{CC} + 0.3	2.2	-	V _{CC} + 0.3	V
V _{IL}	Input LOW voltage	V _{CC} = 2.2 V to 2.7 V	-0.3	-	0.6	-0.3	-	0.6	V
		V _{CC} = 2.7 V to 3.6 V	-0.3	-	0.8	-0.3	-	0.8	V
I _{IX}	Input leakage current	GND ≤ V _I ≤ V _{CC}	-1	-	+1	-4	-	+4	μA
I _{OZ}	Output leakage current	GND ≤ V _O ≤ V _{CC} , output disabled	-1	-	+1	-4	-	+4	μA
I _{CC}	V _{CC} operating supply current	f = f _{max} = 1/t _{RC} V _{CC} = V _{CC(max)} I _{OUT} = 0 mA CMOS levels	-	15	20	-	15	25	mA
		f = 1 MHz	-	2	2.5	-	2	3	
I _{SB1}	Automatic CE power-down current – CMOS inputs	$\overline{CE} \geq V_{CC} - 0.2$ V $V_{IN} \geq V_{CC} - 0.2$ V, $V_{IN} \leq 0.2$ V, f = f _{max} (address and data only), f = 0 (OE, BHE, BLE and WE), V _{CC} = 3.60 V	-	1	7	-	1	20	μA
I _{SB2} ^[9]	Automatic CE power-down current – CMOS inputs	$\overline{CE} \geq V_{CC} - 0.2$ V, $V_{IN} \geq V_{CC} - 0.2$ V or $V_{IN} \leq 0.2$ V, f = 0, V _{CC} = 3.60 V	-	1	7	-	1	20	μA

Notes

- V_{IL(min)} = -2.0 V for pulse durations less than 20 ns.
- V_{IH(max)} = V_{CC} + 0.75 V for pulse durations less than 20 ns.
- Full device AC operation assumes a minimum of 100 μs ramp time from 0 to V_{CC(min)} and 200 μs wait time after V_{CC} stabilization.
- Typical values are included for reference only and are not guaranteed or tested. Typical values are measured at V_{CC} = V_{CC(typ)}, T_A = 25 °C.
- Chip enable (\overline{CE}) and byte enables (\overline{BHE} and \overline{BLE}) need to be tied to CMOS levels to meet the I_{SB2} / I_{CCDR} spec. Other inputs can be left floating.

Capacitance

For all packages.

Parameter ^[10]	Description	Test Conditions	Max	Unit
C _{IN}	Input capacitance	T _A = 25 °C, f = 1 MHz, V _{CC} = V _{CC(typ)}	10	pF
C _{OUT}	Output capacitance		10	pF

Thermal Resistance

Parameter ^[10]	Description	Test Conditions	VFBGA Package	TSOP II Package	Unit
Θ _{JA}	Thermal resistance (junction to ambient)	Still Air, soldered on a 3 × 4.5 inch, four-layer printed circuit board	42.10	55.52	°C/W
Θ _{JC}	Thermal resistance (junction to case)		23.45	16.03	°C/W

AC Test Load and Waveforms

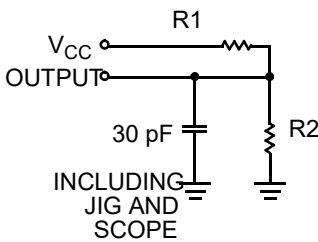
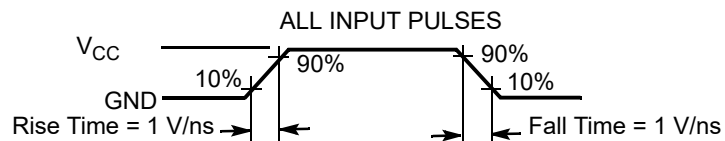

Figure 4. AC Test Load and Waveforms



Equivalent to: THEVENIN EQUIVALENT



Parameters	2.50 V	3.0 V	Unit
R1	16667	1103	Ω
R2	15385	1554	Ω
R _{TH}	8000	645	Ω
V _{TH}	1.20	1.75	V

Note

10. Tested initially and after any design or process changes that may affect these parameters.

Data Retention Characteristics

Over the Operating Range

Parameter	Description	Conditions	Min	Typ ^[11]	Max	Unit
V_{DR}	V_{CC} for data retention		1.5	–	–	V
I_{CCDR} ^[12]	Data retention current	$V_{CC} = 1.5\text{ V}$, $\overline{CE} \geq V_{CC} - 0.2\text{ V}$, $V_{IN} \geq V_{CC} - 0.2\text{ V}$ or $V_{IN} \leq 0.2\text{ V}$				μA
		Automotive-A	–	0.8	7	
		Automotive-E	–	–	12	
t_{CDR} ^[13]	Chip deselect to data retention time		0	–	–	ns
t_R ^[14]	Operation recovery time					
		CY62147EV30LL-45	45	–	–	ns
		CY62147EV30LL-55	55	–	–	ns

Data Retention Waveform

Figure 5. Data Retention Waveform^[15, 16]

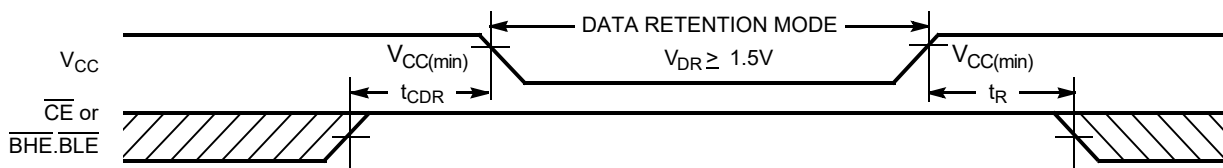

Notes

11. Typical values are included for reference only and are not guaranteed or tested. Typical values are measured at $V_{CC} = V_{CC(\text{typ})}$, $T_A = 25\text{ }^\circ\text{C}$.
12. Chip enable (\overline{CE}) and byte enables (\overline{BHE} and \overline{BLE}) need to be tied to CMOS levels to meet the I_{SB2} / I_{CCDR} spec. Other inputs can be left floating.
13. Tested initially and after any design or process changes that may affect these parameters.
14. Full device operation requires linear V_{CC} ramp from V_{DR} to $V_{CC(\text{min})} \geq 100\text{ }\mu\text{s}$ or stable at $V_{CC(\text{min})} \geq 100\text{ }\mu\text{s}$.
15. BGA packaged device is offered in single CE and dual CE options. In this data sheet, for a dual CE device, \overline{CE} refers to the internal logical combination of \overline{CE}_1 and \overline{CE}_2 such that when \overline{CE}_1 is LOW and \overline{CE}_2 is HIGH, \overline{CE} is LOW. For all other cases \overline{CE} is HIGH.
16. $\overline{BHE.BLE}$ is the AND of both \overline{BHE} and \overline{BLE} . Deselect the chip by either disabling the chip enable signals or by disabling both \overline{BHE} and \overline{BLE} .

Switching Characteristics

Over the Operating Range

Parameter [17, 18]	Description	45 ns (Automotive-A)		55 ns (Automotive-E)		Unit
		Min	Max	Min	Max	
Read Cycle						
t_{RC}	Read cycle time	45	–	55	–	ns
t_{AA}	Address to data valid	–	45	–	55	ns
t_{OHA}	Data hold from address change	10	–	10	–	ns
t_{ACE}	\overline{CE} LOW to data valid	–	45	–	55	ns
t_{DOE}	\overline{OE} LOW to data valid	–	22	–	25	ns
t_{LZOE}	\overline{OE} LOW to Low Z [19]	5	–	5	–	ns
t_{HZOE}	\overline{OE} HIGH to High Z [19, 20]	–	18	–	20	ns
t_{LZCE}	\overline{CE} LOW to Low Z [19]	10	–	10	–	ns
t_{HZCE}	\overline{CE} HIGH to High Z [19, 20]	–	18	–	20	ns
t_{PU}	\overline{CE} LOW to power-up	0	–	0	–	ns
t_{PD}	\overline{CE} HIGH to power-down	–	45	–	55	ns
t_{DBE}	$\overline{BLE}/\overline{BHE}$ LOW to data valid	–	45	–	55	ns
t_{LZBE}	$\overline{BLE}/\overline{BHE}$ LOW to Low Z [19]	10	–	10	–	ns
t_{HZBE}	$\overline{BLE}/\overline{BHE}$ HIGH to High Z [19, 20]	–	18	–	20	ns
Write Cycle [21]						
t_{WC}	Write cycle time	45	–	55	–	ns
t_{SCE}	\overline{CE} LOW to write end	35	–	40	–	ns
t_{AW}	Address setup to write end	35	–	40	–	ns
t_{HA}	Address hold from write end	0	–	0	–	ns
t_{SA}	Address setup to write start	0	–	0	–	ns
t_{PWE}	\overline{WE} pulse width	35	–	40	–	ns
t_{BW}	$\overline{BLE}/\overline{BHE}$ LOW to write end	35	–	40	–	ns
t_{SD}	Data setup to write end	25	–	25	–	ns
t_{HD}	Data hold from write end	0	–	0	–	ns
t_{HZWE}	\overline{WE} LOW to High Z [19, 20]	–	18	–	20	ns
t_{LZWE}	\overline{WE} HIGH to Low Z [19]	10	–	10	–	ns

Notes

17. Test conditions for all parameters other than tri-state parameters assume signal transition time of 3 ns (1V/ns) or less, timing reference levels of $V_{CC(typ)}/2$, input pulse levels of 0 to $V_{CC(typ)}$, and output loading of the specified I_{OL}/I_{OH} as shown in the Figure 4 on page 6.

18. AC timing parameters are subject to byte enable signals (BHE or BLE) not switching when chip is disabled. See application note AN13842 for further clarification.

19. At any temperature and voltage condition, t_{HZCE} is less than t_{LZCE} , t_{HZBE} is less than t_{LZBE} , t_{HZOE} is less than t_{LZOE} , and t_{HZWE} is less than t_{LZWE} for any device.

20. t_{HZOE} , t_{HZCE} , t_{HZBE} , and t_{HZWE} transitions are measured when the outputs enter a high-impedance state.

21. The internal write time of the memory is defined by the overlap of \overline{WE} , $\overline{CE} = V_{IL}$, BHE, BLE, or both = V_{IL} . All signals must be active to initiate a write and any of these signals can terminate a write by going inactive. The data input setup and hold timing must be referenced to the edge of the signal that terminates the write.

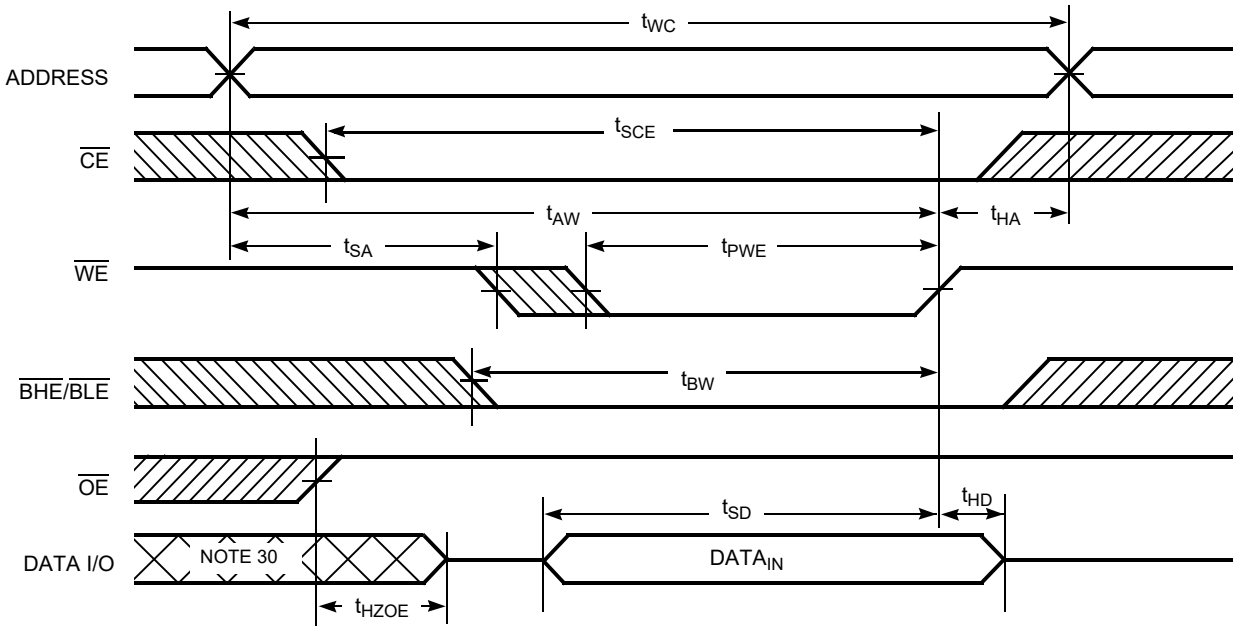
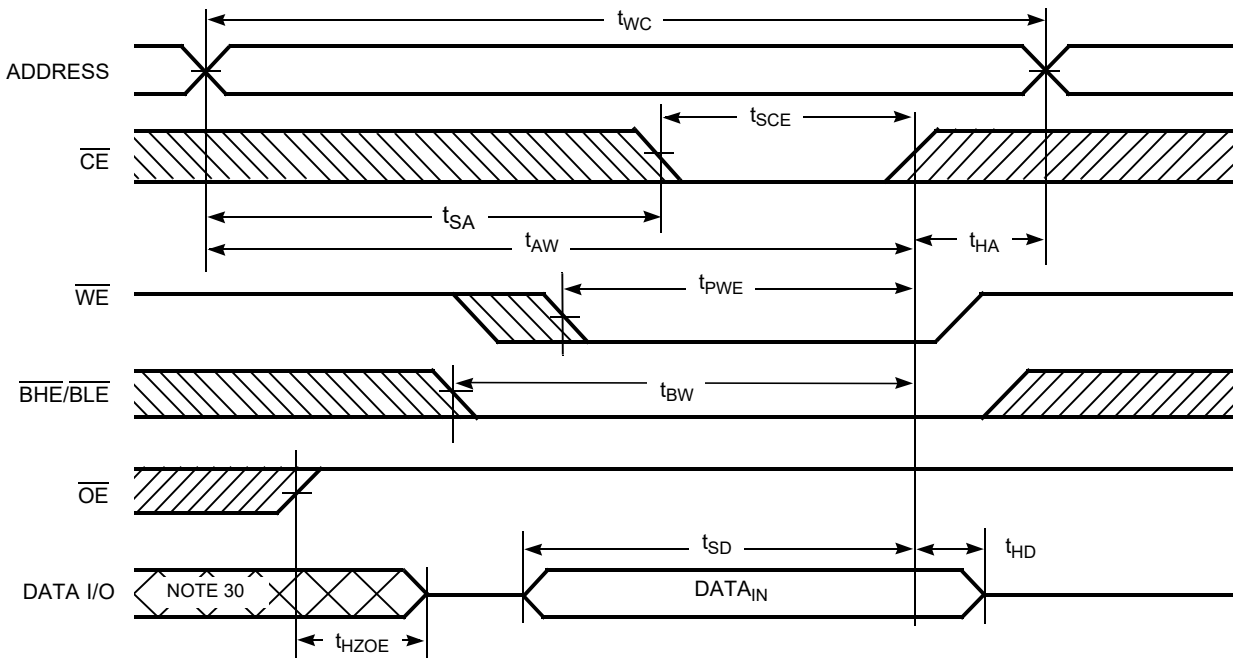
Switching Waveforms (continued)
Figure 8. Write Cycle No. 1: $\overline{\text{WE}}$ Controlled [26, 27, 28, 29]

Figure 9. Write Cycle No. 2: $\overline{\text{CE}}$ Controlled [26, 27, 28, 29]

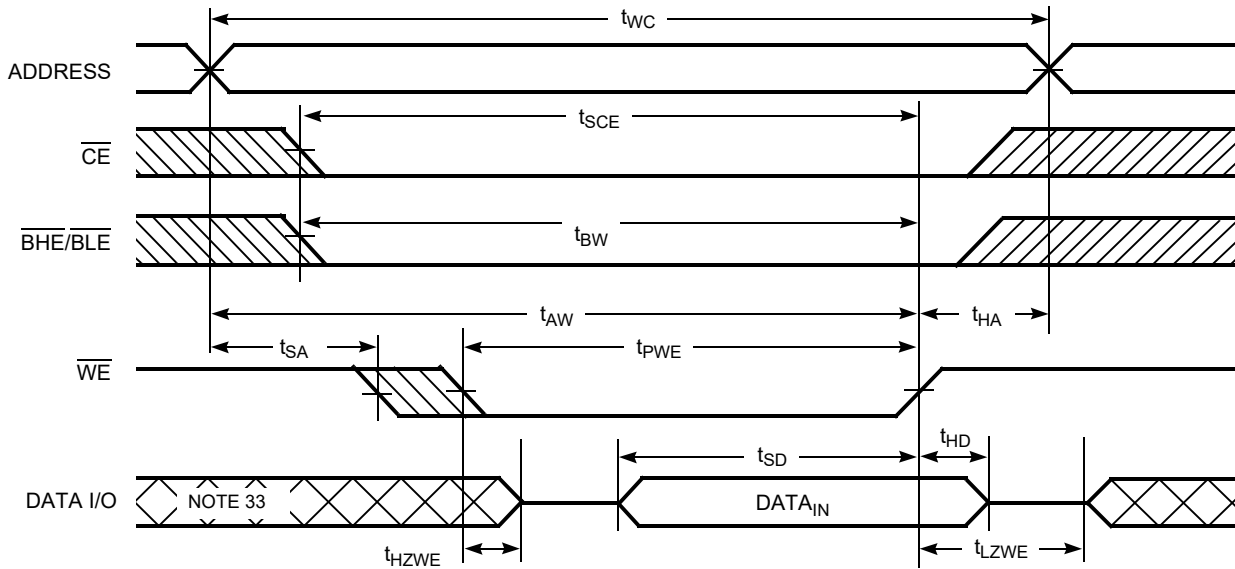
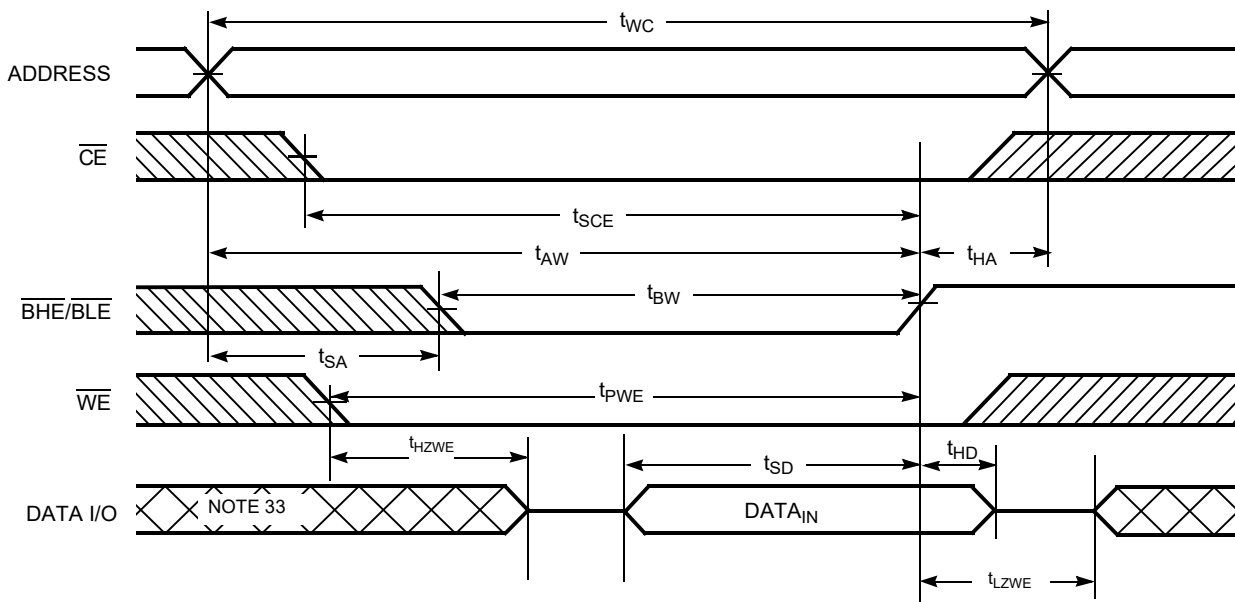
Notes

26. BGA packaged device is offered in single CE and dual CE options. In this datasheet, for a dual CE device, $\overline{\text{CE}}$ refers to the internal logical combination of $\overline{\text{CE}}_1$ and $\overline{\text{CE}}_2$ such that when $\overline{\text{CE}}_1$ is LOW and $\overline{\text{CE}}_2$ is HIGH, $\overline{\text{CE}}$ is LOW. For all other cases $\overline{\text{CE}}$ is HIGH.
27. The internal write time of the memory is defined by the overlap of $\overline{\text{WE}}$, $\overline{\text{CE}} = V_{\text{IL}}$, $\overline{\text{BHE}}$, $\overline{\text{BLE}}$, or both = V_{IL} . All signals must be active to initiate a write and any of these signals can terminate a write by going inactive. The data input setup and hold timing must be referenced to the edge of the signal that terminates the write.
28. Data I/O is high impedance if $\overline{\text{OE}} = V_{\text{IH}}$.
29. If $\overline{\text{CE}}$ goes HIGH simultaneously with $\overline{\text{WE}} = V_{\text{IH}}$, the output remains in a high impedance state.
30. During this period, the I/Os are in output state. Do not apply input signals.

Switching Waveforms (continued)
Figure 10. Write Cycle No. 3: \overline{WE} Controlled, \overline{OE} LOW [31, 32]

Figure 11. Write Cycle No. 4: $\overline{BHE/BLE}$ Controlled, \overline{OE} LOW [31, 32]

Notes

31. BGA packaged device is offered in single CE and dual CE options. In this datasheet, for a dual CE device, \overline{CE} refers to the internal logical combination of \overline{CE}_1 and \overline{CE}_2 such that when \overline{CE}_1 is LOW and \overline{CE}_2 is HIGH, \overline{CE} is LOW. For all other cases \overline{CE} is HIGH.
32. If \overline{CE} goes HIGH simultaneously with $\overline{WE} = V_{IH}$, the output remains in a high-impedance state.
33. During this period, the I/Os are in output state. Do not apply input signals.

Truth Table

\overline{CE} [34, 35]	\overline{WE}	\overline{OE}	\overline{BHE}	\overline{BLE}	I/Os	Mode	Power
H	X	X	X	X	High Z	Deselect/power-down	Standby (I_{SB})
L	X	X	H	H	High Z	Deselect/power-down	Standby (I_{SB})
L	H	L	L	L	Data out (I/O ₀ –I/O ₁₅)	Read	Active (I_{CC})
L	H	L	H	L	Data out (I/O ₀ –I/O ₇); I/O ₈ –I/O ₁₅ in High Z	Read	Active (I_{CC})
L	H	L	L	H	Data out (I/O ₈ –I/O ₁₅); I/O ₀ –I/O ₇ in High Z	Read	Active (I_{CC})
L	H	H	L	L	High Z	Output disabled	Active (I_{CC})
L	H	H	H	L	High Z	Output disabled	Active (I_{CC})
L	H	H	L	H	High Z	Output disabled	Active (I_{CC})
L	L	X	L	L	Data in (I/O ₀ –I/O ₁₅)	Write	Active (I_{CC})
L	L	X	H	L	Data in (I/O ₀ –I/O ₇); I/O ₈ –I/O ₁₅ in High Z	Write	Active (I_{CC})
L	L	X	L	H	Data in (I/O ₈ –I/O ₁₅); I/O ₀ –I/O ₇ in High Z	Write	Active (I_{CC})

Notes

34. BGA packaged device is offered in single CE and dual CE options. In this data sheet, for a dual CE device, \overline{CE} refers to the internal logical combination of \overline{CE}_1 and \overline{CE}_2 such that when \overline{CE}_1 is LOW and \overline{CE}_2 is HIGH, \overline{CE} is LOW. For all other cases \overline{CE} is HIGH.
35. For the Dual Chip Enable device, \overline{CE} refers to the internal logical combination of \overline{CE}_1 and \overline{CE}_2 such that when \overline{CE}_1 is LOW and \overline{CE}_2 is HIGH, \overline{CE} is LOW. For all other cases \overline{CE} is HIGH. Intermediate voltage levels is not permitted on any of the Chip Enable pins (\overline{CE} for the Single Chip Enable device; \overline{CE}_1 and \overline{CE}_2 for the Dual Chip Enable device).

Package Diagrams

Figure 12. 48-ball VFBGA (6 × 8 × 1.0 mm) BV48/BZ48 Package Outline, 51-85150

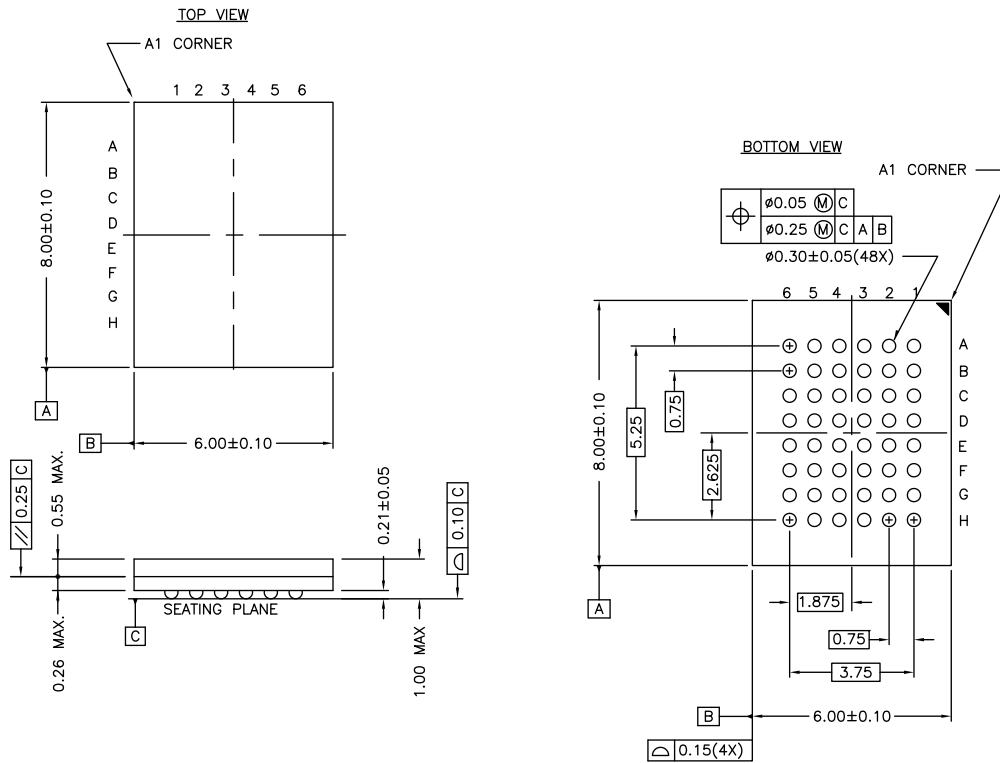

NOTE:
 PACKAGE WEIGHT: See Cypress Package Material Declaration Datasheet (PMDD)
 posted on the Cypress web.

51-85150 *H

Package Diagrams (continued)

Figure 13. 44-pin TSOP Z44-II Package Outline, 51-85087

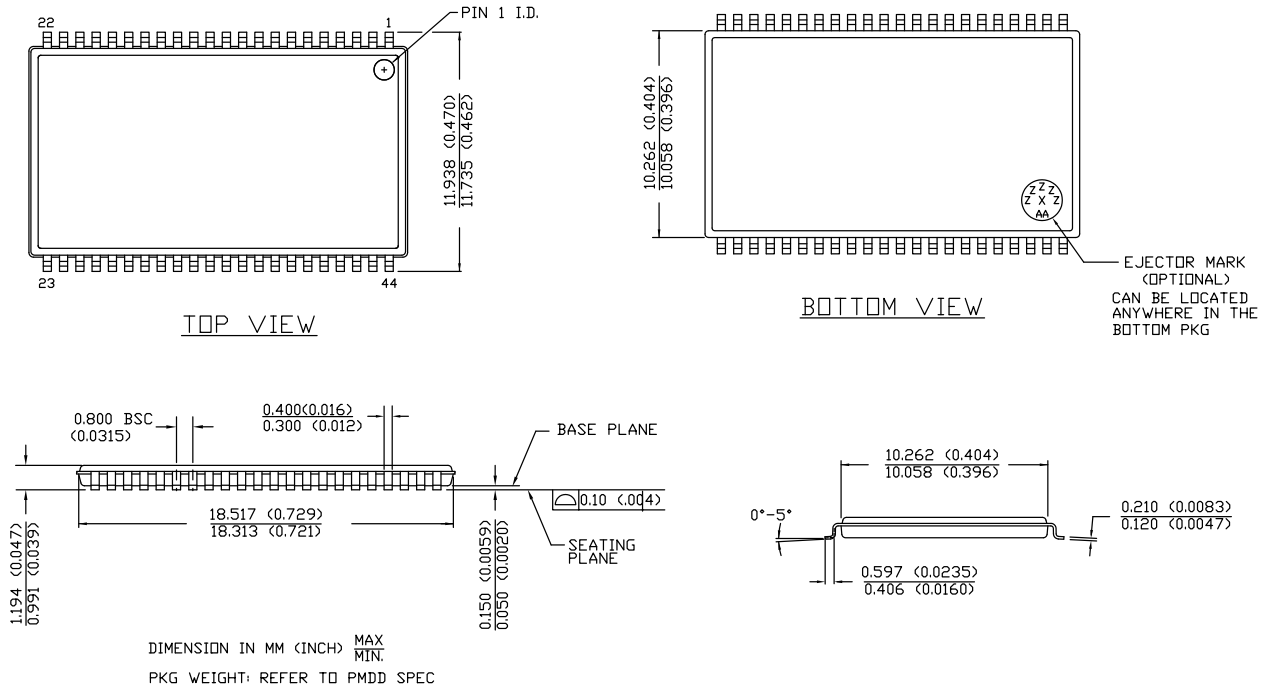

51-85087 *E

Acronyms

Acronym	Description
CMOS	Complementary Metal Oxide Semiconductor
I/O	Input/Output
SRAM	Static Random Access Memory
VFBGA	Very Fine-Pitch Ball Grid Array
TSOP	Thin Small Outline Package

Document Conventions

Units of Measure

Symbol	Unit of Measure
°C	degree Celsius
MHz	megahertz
μA	microampere
mA	milliampere
ns	nanosecond
Ω	ohm
pF	picofarad
V	volt
W	watt

Document History Page

Document Title: CY62147EV30 MoBL [®] Automotive, 4-Mbit (256K × 16) Static RAM				
Document Number: 001-66256				
Rev.	ECN No.	Orig. of Change	Submission Date	Description of Change
**	3123973	RAME	01/31/2011	Created new datasheet for Automotive parts from document number 38-05440 Rev. *I
*A	3937956	MEMJ	03/19/2013	Updated Package Diagrams : spec 51-85150 – Changed revision from *F to *H. spec 51-85087 – Changed revision from *C to *E. Completing Sunset Review.
*B	4725832	PSR	04/15/2015	Updated Functional Description : Removed “For best practice recommendations, refer to the Cypress application note AN1064, SRAM System Guidelines. ” at the end. Added “For a complete list of related resources, click here. ” at the end. Updated to new template.
*C	5221444	VINI	04/14/2016	Updated Thermal Resistance : Updated details in “Test Conditions” column and updated all values in “VFBGA Package” and “TSOP II Package” columns corresponding to θ_{JA} and θ_{JC} parameters. Updated to new template. Completing Sunset Review.
*D	6049466	VINI	01/29/2018	Updated Ordering Information : Updated part numbers. Removed Note “This BGA package is offered with single chip enable.” and its reference. Removed Note “This BGA package is offered with dual chip enable.” and its reference. Updated Ordering Code Definitions . Updated to new template. Completing Sunset Review.

Sales, Solutions, and Legal Information

Worldwide Sales and Design Support

Cypress maintains a worldwide network of offices, solution centers, manufacturer's representatives, and distributors. To find the office closest to you, visit us at [Cypress Locations](#).

Products

Arm® Cortex® Microcontrollers	cypress.com/arm
Automotive	cypress.com/automotive
Clocks & Buffers	cypress.com/clocks
Interface	cypress.com/interface
Internet of Things	cypress.com/iot
Memory	cypress.com/memory
Microcontrollers	cypress.com/mcu
PSoC	cypress.com/psoc
Power Management ICs	cypress.com/pmic
Touch Sensing	cypress.com/touch
USB Controllers	cypress.com/usb
Wireless Connectivity	cypress.com/wireless

PSoC® Solutions

[PSoC 1](#) | [PSoC 3](#) | [PSoC 4](#) | [PSoC 5LP](#) | [PSoC 6 MCU](#)

Cypress Developer Community

[Community](#) | [Projects](#) | [Video](#) | [Blogs](#) | [Training](#) | [Components](#)

Technical Support

cypress.com/support



© Cypress Semiconductor Corporation, 2011-2018. This document is the property of Cypress Semiconductor Corporation and its subsidiaries, including Spansion LLC ("Cypress"). This document, including any software or firmware included or referenced in this document ("Software"), is owned by Cypress under the intellectual property laws and treaties of the United States and other countries worldwide. Cypress reserves all rights under such laws and treaties and does not, except as specifically stated in this paragraph, grant any license under its patents, copyrights, trademarks, or other intellectual property rights. If the Software is not accompanied by a license agreement and you do not otherwise have a written agreement with Cypress governing the use of the Software, then Cypress hereby grants you a personal, non-exclusive, nontransferable license (without the right to sublicense) (1) under its copyright rights in the Software (a) for Software provided in source code form, to modify and reproduce the Software solely for use with Cypress hardware products, only internally within your organization, and (b) to distribute the Software in binary code form externally to end users (either directly or indirectly through resellers and distributors), solely for use on Cypress hardware product units, and (2) under those claims of Cypress's patents that are infringed by the Software (as provided by Cypress, unmodified) to make, use, distribute, and import the Software solely for use with Cypress hardware products. Any other use, reproduction, modification, translation, or compilation of the Software is prohibited.

TO THE EXTENT PERMITTED BY APPLICABLE LAW, CYPRESS MAKES NO WARRANTY OF ANY KIND, EXPRESS OR IMPLIED, WITH REGARD TO THIS DOCUMENT OR ANY SOFTWARE OR ACCOMPANYING HARDWARE, INCLUDING, BUT NOT LIMITED TO, THE IMPLIED WARRANTIES OF MERCHANTABILITY AND FITNESS FOR A PARTICULAR PURPOSE. To the extent permitted by applicable law, Cypress reserves the right to make changes to this document without further notice. Cypress does not assume any liability arising out of the application or use of any product or circuit described in this document. Any information provided in this document, including any sample design information or programming code, is provided only for reference purposes. It is the responsibility of the user of this document to properly design, program, and test the functionality and safety of any application made of this information and any resulting product. Cypress products are not designed, intended, or authorized for use as critical components in systems designed or intended for the operation of weapons, weapons systems, nuclear installations, life-support devices or systems, other medical devices or systems (including resuscitation equipment and surgical implants), pollution control or hazardous substances management, or other uses where the failure of the device or system could cause personal injury, death, or property damage ("Unintended Uses"). A critical component is any component of a device or system whose failure to perform can be reasonably expected to cause the failure of the device or system, or to affect its safety or effectiveness. Cypress is not liable, in whole or in part, and you shall and hereby do release Cypress from any claim, damage, or other liability arising from or related to all Unintended Uses of Cypress products. You shall indemnify and hold Cypress harmless from and against all claims, costs, damages, and other liabilities, including claims for personal injury or death, arising from or related to any Unintended Uses of Cypress products.

Cypress, the Cypress logo, Spansion, the Spansion logo, and combinations thereof, WICED, PSoC, CapSense, EZ-USB, F-RAM, and Traveo are trademarks or registered trademarks of Cypress in the United States and other countries. For a more complete list of Cypress trademarks, visit cypress.com. Other names and brands may be claimed as property of their respective owners.

Looking for pricing, stock, or lifecycle information?

Click below to explore more details on WIN SOURCE:

-  [View CY62147EV30LL-45BVXA on WIN SOURCE](#)
-  [Cypress Semiconductor Corp Information](#)

Optimize Your Supply Chain with WIN SOURCE Solutions

-  Global Sourcing Solution
-  Obsolete Management
-  Cost Control Management
-  Shortage Management
-  Alternative Solution
-  Excess Inventory Management