



THE DATASHEET OF SC03-12HDB



P/N: SC03-12HDB

BRIGHT RED

Features

- 0.3 INCH DIGIT HEIGHT.
- LOW CURRENT OPERATION.
- EXCELLENT CHARACTER APPEARANCE.
- EASY MOUNTING ON P.C . BOARDS OR SOCKETS.
- I.C. COMPATIBLE.
- CATEGORIZED FOR LUMINOUS INTENSITY.
- MECHANICALLY RUGGED.
- STANDARD : BLACK FACE, RED SEGMENT.
- RoHS COMPLIANT.

Description

The Bright Red source color devices are made with Gallium Phosphide Red Light Emitting Diode.

Package Dimensions & Internal Circuit Diagram

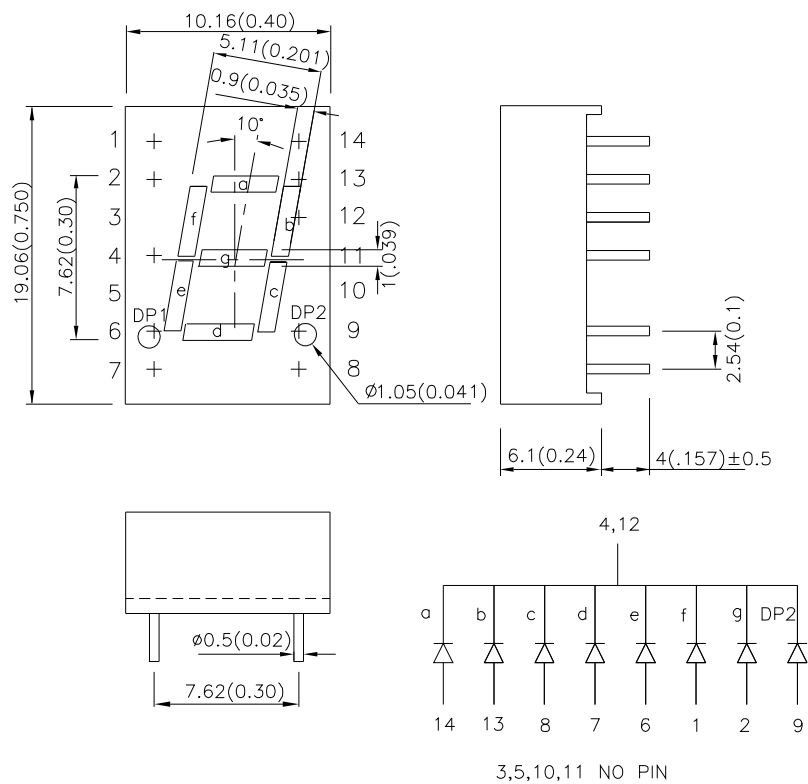

Notes:

1. All dimensions are in millimeters (inches), Tolerance is ± 0.25 (0.01") unless otherwise noted.
2. Specifications are subject to change without notice.

Selection Guide

Part No.	Dice	Lens Type	Iv (ucd) [1] @ 10mA		Description
			Min.	Typ.	
SC03-12HDB	BRIGHT RED (GaP)	RED DIFFUSED	480	1200	Common Cathode, Rt. Hand Decimal.

Note:

1. Luminous Intensity/ Luminous Flux: +/-15%

Electrical / Optical Characteristics at T_A=25°C

Symbol	Parameter	Device	Typ.	Max.	Units	Test Conditions
λ_{peak}	Peak Wavelength	Bright Red	700		nm	I _F =20mA
λ_D [1]	Dominant Wavelength	Bright Red	660		nm	I _F =20mA
$\Delta\lambda_{1/2}$	Spectral Line Half-width	Bright Red	45		nm	I _F =20mA
C	Capacitance	Bright Red	40		pF	V _F =0V; f=1MHz
V _F [2]	Forward Voltage	Bright Red	2.25	2.5	V	I _F =20mA
I _R	Reverse Current	Bright Red		10	uA	V _R = 5V

Notes:

1. Wavelength: +/-1nm

2. Forward Voltage: +/-0.1V

Absolute Maximum Ratings at T_A=25°C

Parameter	Bright Red	Units
Power dissipation	120	mW
DC Forward Current	25	mA
Peak Forward Current [1]	130	mA
Reverse Voltage	5	V
Operating/Storage Temperature	-40°C To +85°C	
Lead Solder Temperature [2]	260°C For 5 Seconds	

Notes:

1. 1/10 Duty Cycle, 0.1ms Pulse Width.

2. 2mm below package base.

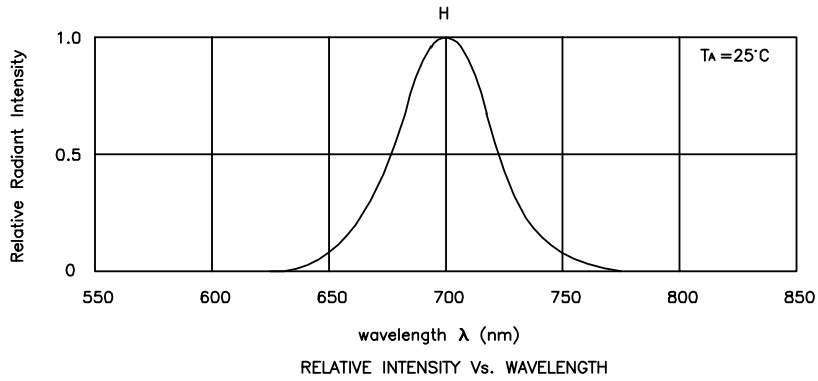

Bright Red

SC03-12HDB

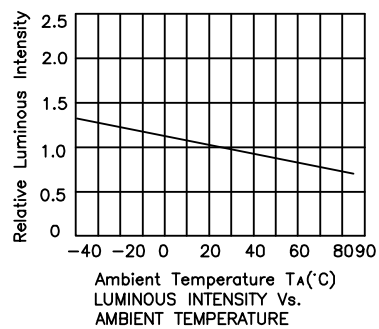
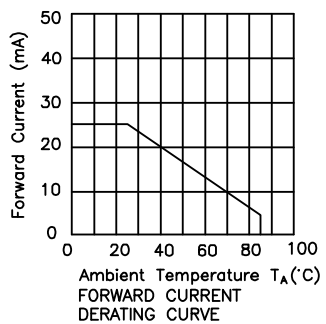
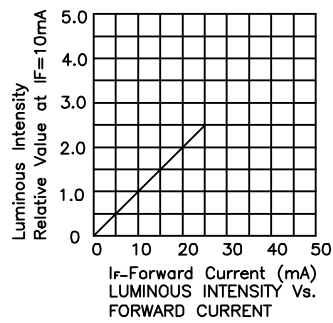
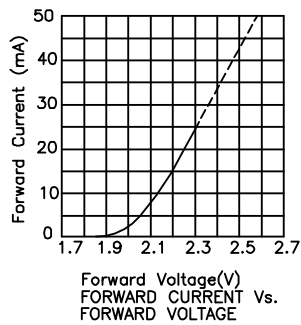

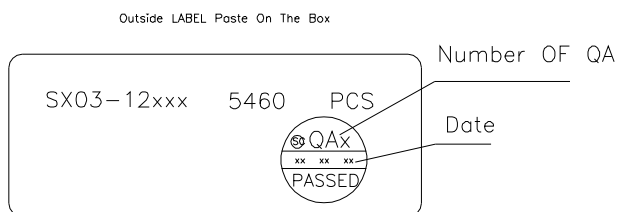
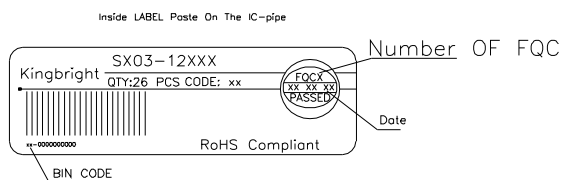
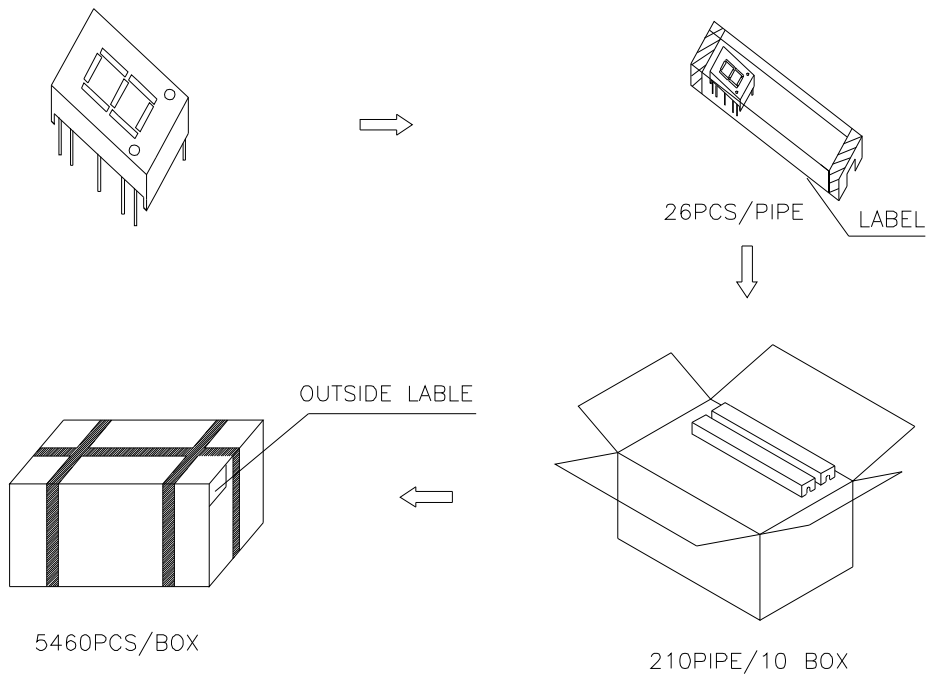

PACKING & LABEL SPECIFICATIONS

SC03-12HDB



Looking for pricing, stock, or lifecycle information?

Click below to explore more details on WIN SOURCE:

-  [View SC03-12HDB on WIN SOURCE](#)
-  [Kingbright Information](#)

Optimize Your Supply Chain with WIN SOURCE Solutions

-  Global Sourcing Solution
-  Obsolete Management
-  Cost Control Management
-  Shortage Management
-  Alternative Solution
-  Excess Inventory Management