



# THE DATASHEET OF SFH 4080-Z



**IR-Lumineszenzdiode**  
**Infrared Emitter**  
**Lead (Pb) Free Product - RoHS Compliant**

**SFH 4080**



**Nicht für Neuentwicklungen im Automobilbereich /**  
**not for new designs in automotive applications**

**Wesentliche Merkmale**

- Sehr kleines Gehäuse:  
(LxBxH) 1,7 mm x 0,8 mm x 0,65 mm
- Typische Peakwellenlänge 880 nm
- Gegurtet lieferbar

**Features**

- Very small package:  
(LxWxH) 1.7 mm x 0.8 mm x 0.65 mm
- Typical Peakwavelength 880 nm
- Available on tape and reel

**Anwendungen**

- Miniaturlichtschranken für Gleich- und Wechsellichtbetrieb
- Industrieelektronik
- „Messen/Steuern/Regeln“
- Sensorik
- Alarm- und Sicherungssysteme
- IR-Freiraumübertragung

**Applications**

- Miniature photointerrupters
- Industrial electronics
- For drive and control circuits
- Sensor technology
- Alarm and safety equipment
- IR free air transmission

Typ Type	Bestellnummer Ordering Code	Strahlstärkegruppierung <sup>1)</sup> ( $I_F = 100 \text{ mA}, t_p = 20 \text{ ms}$ ) Radiant Intensity Grouping <sup>1)</sup> $I_e \text{ (mW/sr)}$
SFH 4080	Q65110A6461	> 1.0 (typ. 2.5)

<sup>1)</sup> gemessen bei einem Raumwinkel  $\Omega = 0.01 \text{ sr}$  / measured at a solid angle of  $\Omega = 0.01 \text{ sr}$

**Grenzwerte** ( $T_A = 25\text{ °C}$ )**Maximum Ratings**

Bezeichnung Parameter	Symbol Symbol	Wert Value	Einheit Unit
Betriebs- und Lagertemperatur Operating and storage temperature range	$T_{op}; T_{stg}$	- 40 ... + 100	°C
Sperrspannung Reverse voltage	$V_R$	5	V
Durchlassstrom Forward current	$I_F$	100	mA
Stoßstrom, $\tau = 10\ \mu\text{s}$ , $D = 0$ Surge current	$I_{FSM}$	2.5	A
Verlustleistung Power dissipation	$P_{tot}$	180	mW
Wärmewiderstand Sperrschicht - Umgebung bei Montage auf FR4 Platine, Padgröße je $5\ \text{mm}^2$ Thermal resistance junction - ambient mounted on PC-board (FR4), padsize $5\ \text{mm}^2$ each	$R_{thJA}$	450	K/W
Wärmewiderstand Sperrschicht - Lötstelle bei Montage auf Metall-Block Thermal resistance junction - soldering point, mounted on metal block	$R_{thJS}$	250	K/W

Kennwerte ( $T_A = 25\text{ °C}$ )

## Characteristics

Bezeichnung Parameter	Symbol Symbol	Wert Value	Einheit Unit
Wellenlänge der Strahlung Wavelength at peak emission $I_F = 100\text{ mA}$ , $t_p = 20\text{ ms}$	$\lambda_{\text{peak}}$	880	nm
Spektrale Bandbreite bei 50% von $I_{\text{max}}$ Spectral bandwidth at 50% of $I_{\text{max}}$ $I_F = 100\text{ mA}$	$\Delta\lambda$	80	nm
Abstrahlwinkel Half angle	$\varphi$	$\pm 80$	Grad deg.
Aktive Chipfläche Active chip area	$A$	0.09	$\text{mm}^2$
Abmessungen der aktiven Chipfläche Dimensions of the active chip area	$L \times B$ $L \times W$	$0.3 \times 0.3$	$\text{mm}^2$
Schaltzeiten, $I_e$ von 10% auf 90% und von 90% auf 10%, bei $I_F = 100\text{ mA}$ , $R_L = 50\ \Omega$ Switching times, $I_e$ from 10% to 90% and from 90% to 10%, $I_F = 100\text{ mA}$ , $R_L = 50\ \Omega$	$t_r$ , $t_f$	0.5	$\mu\text{s}$
Kapazität Capacitance $V_R = 0\text{ V}$ , $f = 1\text{ MHz}$	$C_o$	15	pF
Durchlassspannung Forward voltage $I_F = 100\text{ mA}$ , $t_p = 20\text{ ms}$ $I_F = 1\text{ A}$ , $t_p = 100\ \mu\text{s}$	$V_F$ $V_F$	1.5 ( $\leq 1.8$ ) 3.0 ( $\leq 3.8$ )	V V
Sperrstrom Reverse current $V_R = 5\text{ V}$	$I_R$	0.01 ( $\leq 1$ )	$\mu\text{A}$
Gesamtstrahlungsfluss Total radiant flux $I_F = 100\text{ mA}$ , $t_p = 20\text{ ms}$	$\Phi_e$	23	mW
Temperaturkoeffizient von $I_e$ bzw. $\Phi_e$ , $I_F = 100\text{ mA}$ Temperature coefficient of $I_e$ or $\Phi_e$ , $I_F = 100\text{ mA}$	$TC_I$	- 0.5	%/K
Temperaturkoeffizient von $V_F$ , $I_F = 100\text{ mA}$ Temperature coefficient of $V_F$ , $I_F = 100\text{ mA}$	$TC_V$	- 2	mV/K
Temperaturkoeffizient von $\lambda$ , $I_F = 100\text{ mA}$ Temperature coefficient of $\lambda$ , $I_F = 100\text{ mA}$	$TC_\lambda$	+ 0.25	nm/K

**Strahlstärke  $I_e$  in Achsrichtung**gemessen bei einem Raumwinkel  $\Omega = 0.01$  sr**Radiant Intensity  $I_e$  in Axial Direction**at a solid angle of  $\Omega = 0.01$  sr

Bezeichnung Parameter	Symbol	Werte Values	Einheit Unit
Strahlstärke Radiant intensity $I_F = 100$ mA, $t_p = 20$ ms	$I_{e \text{ min}}$ $I_{e \text{ typ}}$	1.0 2.5	mW/sr mW/sr
Strahlstärke Radiant intensity $I_F = 1$ A, $t_p = 100$ $\mu$ s	$I_{e \text{ typ}}$	22	mW/sr

**Relative Spectral Emission**

$I_{rel} = f(\lambda)$

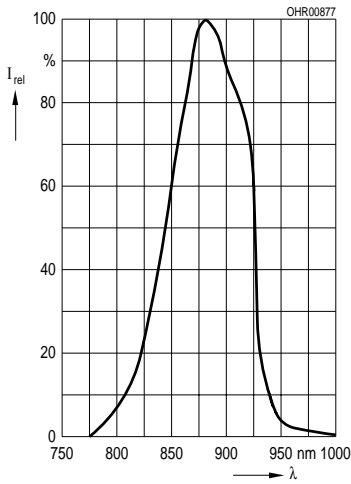

**Radiant Intensity**  $\frac{I_e}{I_e 100 \text{ mA}} = f(I_F)$

Single pulse,  $t_p = 20 \mu\text{s}$

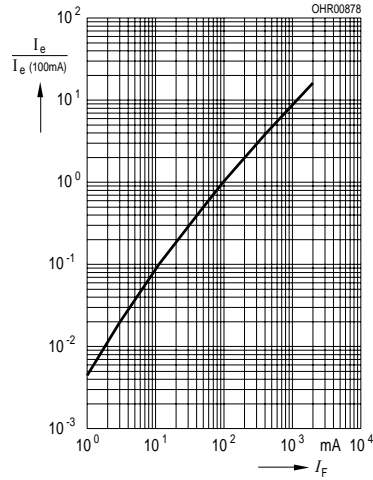

**Max. Permissible Forward Current**

$I_F = f(T_A), R_{thJA} = 450 \text{ K/W}$

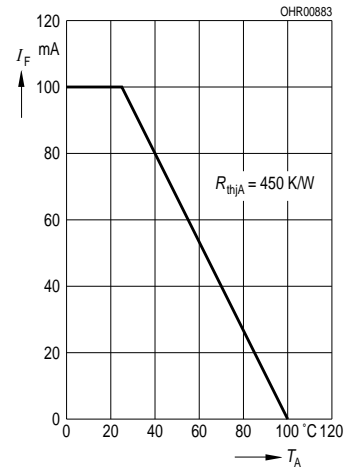

**Forward Current**

$I_F = f(V_F)$  single pulse,  $t_p = 20 \mu\text{s}$

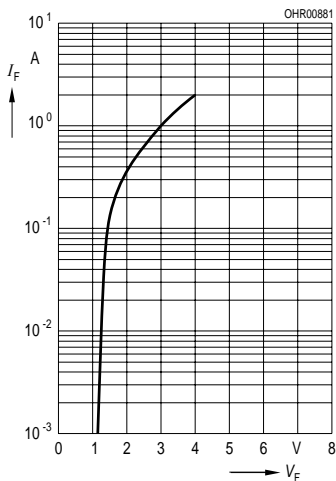

**Permissible Pulse Handling Capability**

$I_F = f(t_p), T_A = 25 \text{ °C}$   
duty cycle  $D =$  parameter

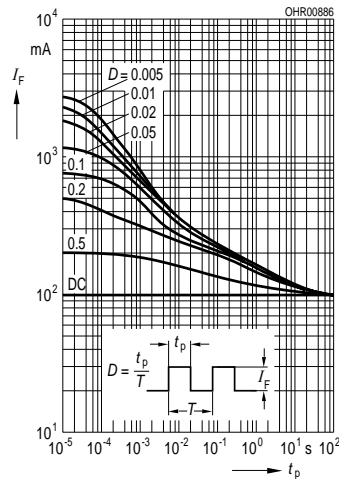

**Radiation Characteristics**  $I_{rel} = f(\varphi)$

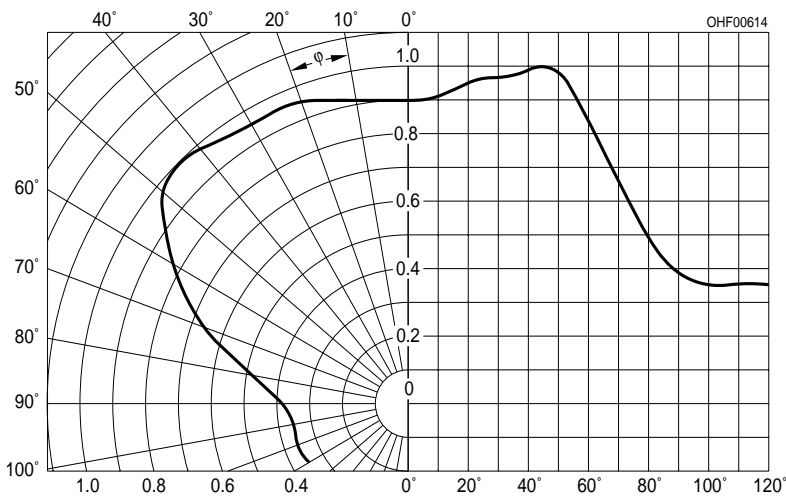

## Maßzeichnung Package Outlines

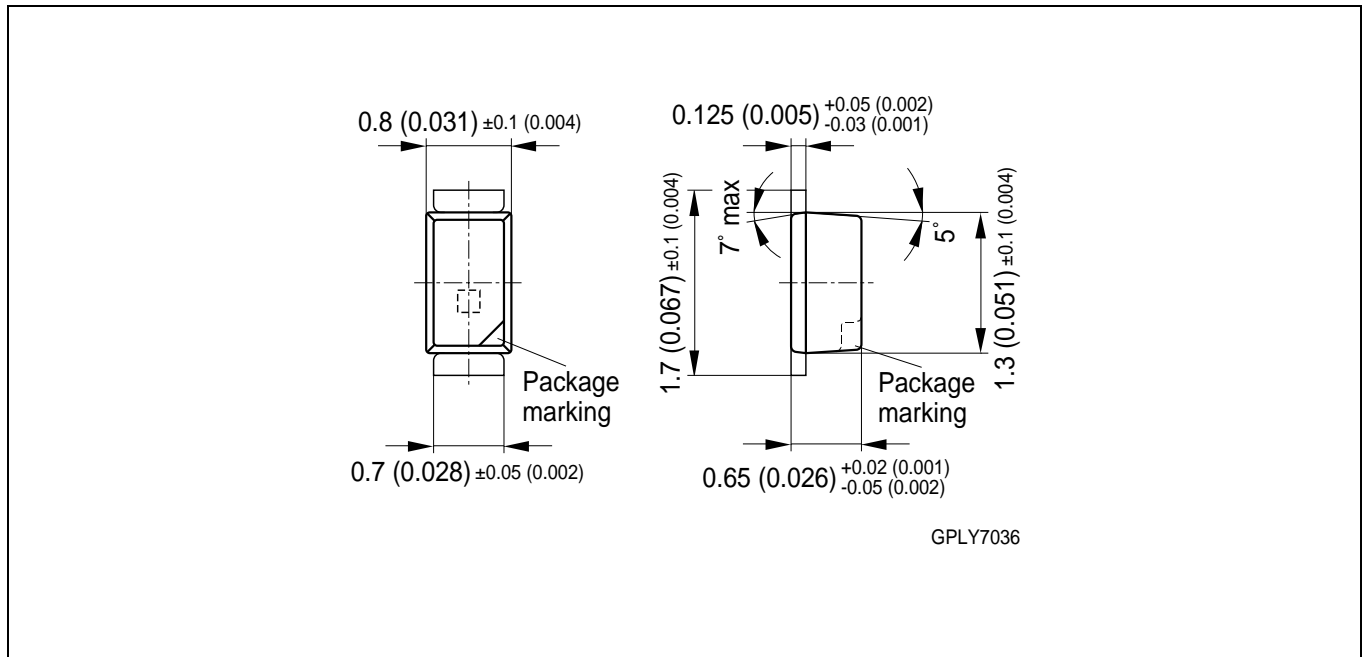

Maße in mm (inch) / Dimensions in mm (inch).

Gehäuse / Package	Epoxydharz, diffus / Epoxy, diffuse
Farbe / Colour	Farblos / colourless
Gehäusemarkierung/ Package marking	Anode

**Empfohlenes Lötpad design**  
**Recommended Solder Pad**

Reflow Löten  
 Reflow Soldering

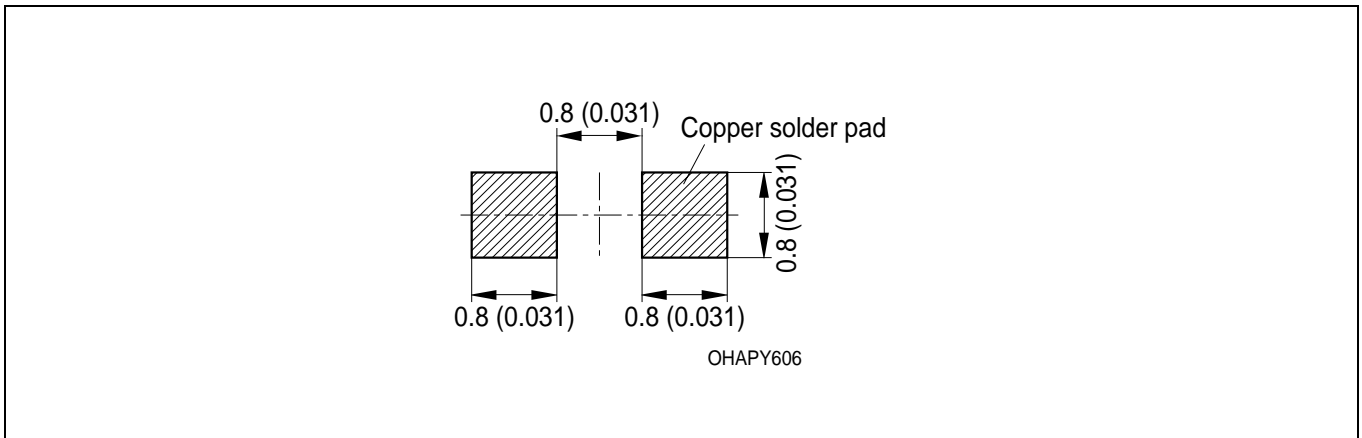

**Alternatives Lötpad design**  
**Alternative Solder Pad**

Reflow Löten  
 Reflow Soldering

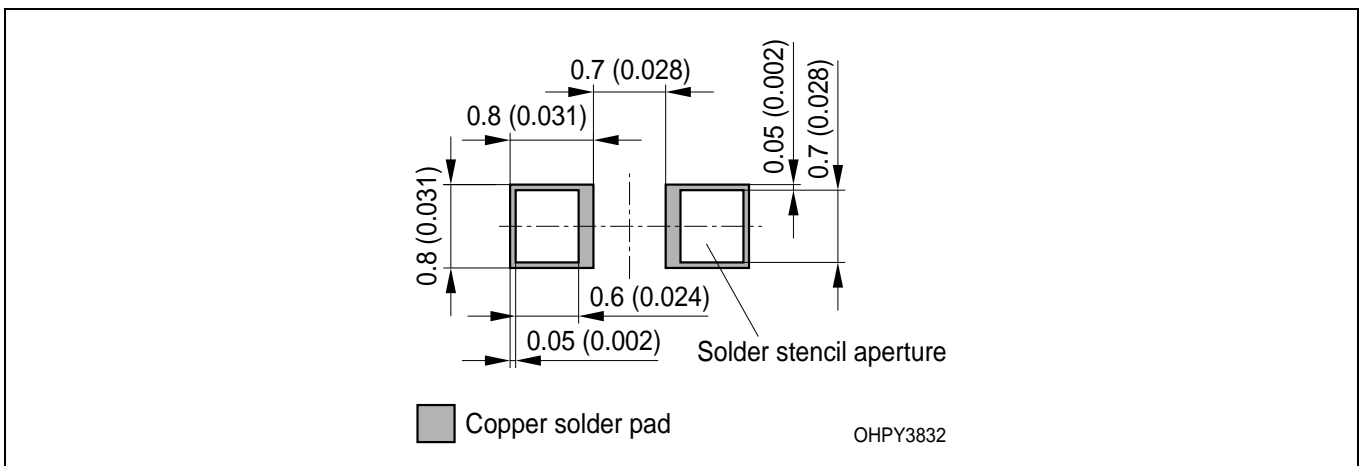

Maße in mm (inch) / Dimensions in mm (inch).

**Lötbedingungen**  
**Soldering Conditions**  
**Reflow Lötprofil für bleifreies Löten**  
**Reflow Soldering Profile for lead free soldering**

Vorbehandlung nach JEDEC Level 2  
 Preconditioning acc. to JEDEC Level 2  
 (nach J-STD-020C)  
 (acc. to J-STD-020C)

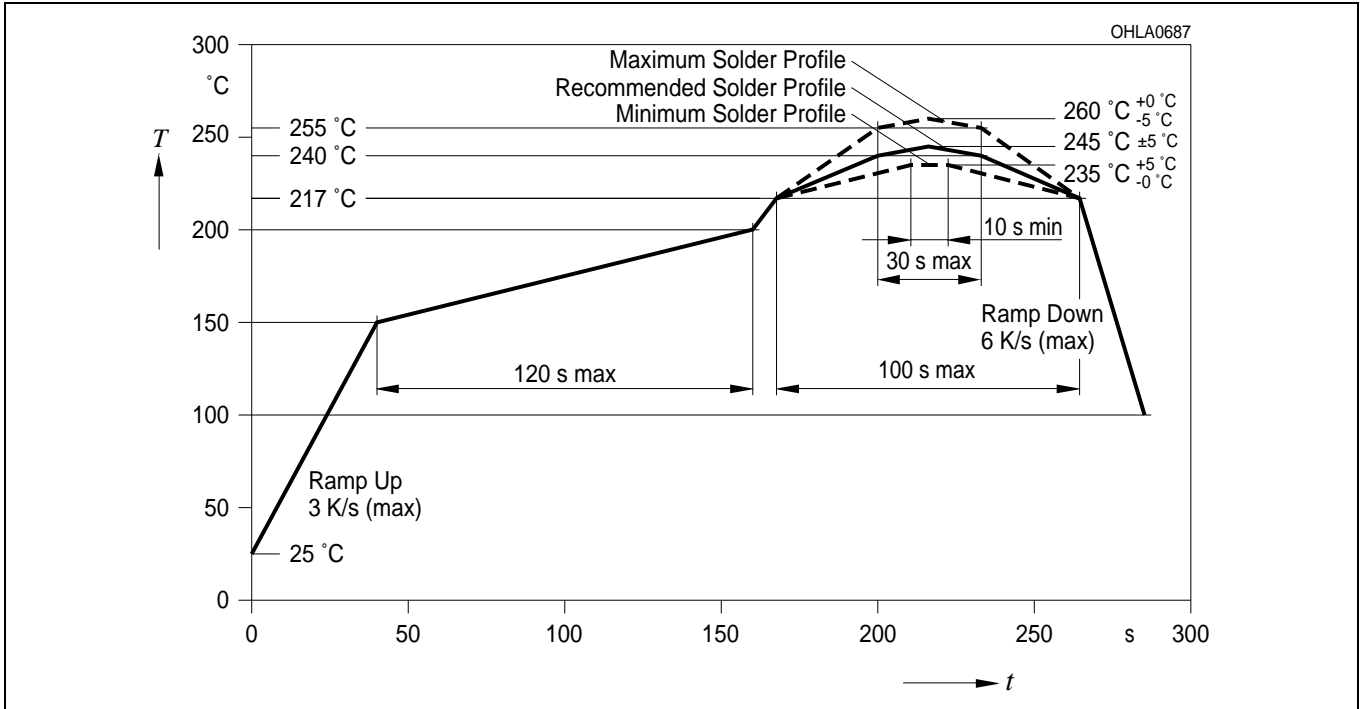

**Wellenlöten (TTW)**  
**TTW Soldering**

(nach CECC 00802)  
 (acc. to CECC 00802)

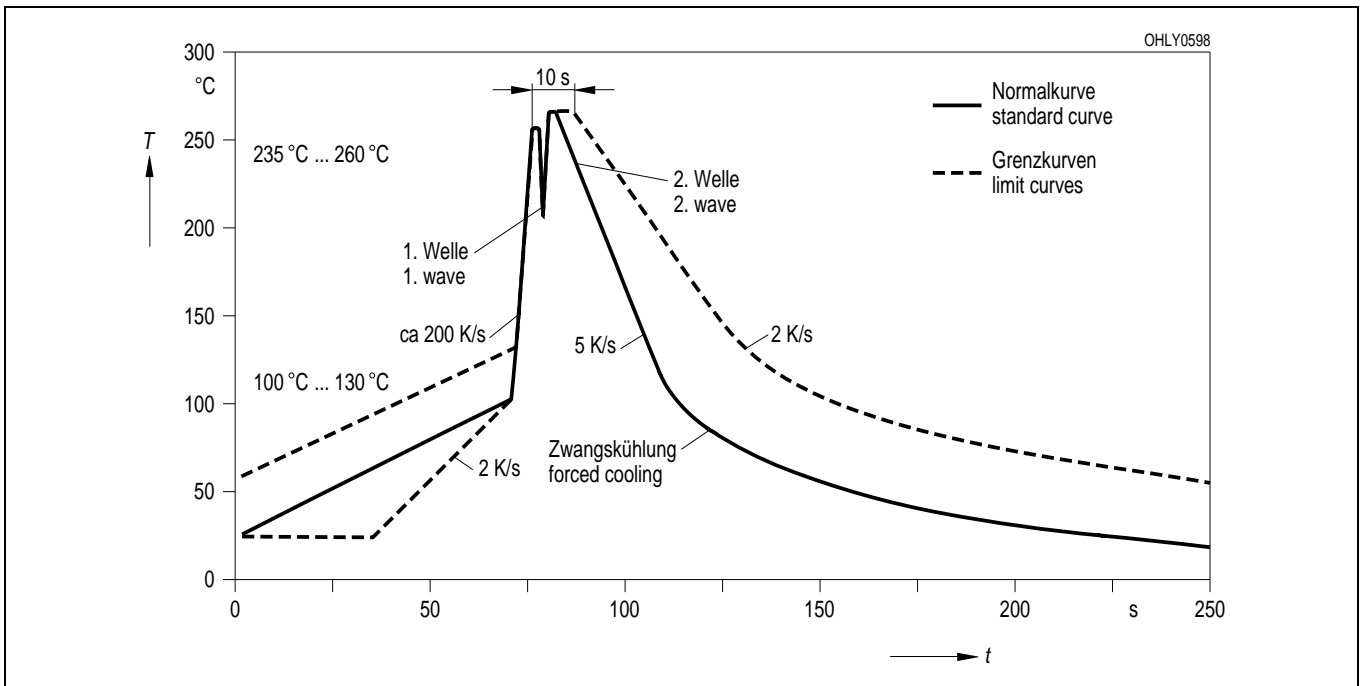

Published by  
**OSRAM Opto Semiconductors GmbH**  
Wernerwerkstrasse 2, D-93049 Regensburg  
[www.osram-os.com](http://www.osram-os.com)

© All Rights Reserved.

The information describes the type of component and shall not be considered as assured characteristics. Terms of delivery and rights to change design reserved. Due to technical requirements components may contain dangerous substances. For information on the types in question please contact our Sales Organization.

#### Packing

Please use the recycling operators known to you. We can also help you – get in touch with your nearest sales office. By agreement we will take packing material back, if it is sorted. You must bear the costs of transport. For packing material that is returned to us unsorted or which we are not obliged to accept, we shall have to invoice you for any costs incurred.

**Components used in life-support devices or systems must be expressly authorized for such purpose!** Critical components<sup>1</sup>, may only be used in life-support devices or systems<sup>2</sup> with the express written approval of OSRAM OS.

<sup>1</sup> A critical component is a component used in a life-support device or system whose failure can reasonably be expected to cause the failure of that life-support device or system, or to affect its safety or effectiveness of that device or system.

<sup>2</sup> Life support devices or systems are intended (a) to be implanted in the human body, or (b) to support and/or maintain and sustain human life. If they fail, it is reasonable to assume that the health of the user may be endangered.

EU RoHS and China RoHS compliant product





此产品符合欧盟 RoHS 指令的要求；

按照中国的相关法规和标准，不含有毒有害物质或元素。

## Looking for pricing, stock, or lifecycle information?

Click below to explore more details on WIN SOURCE:

-  [View SFH 4080-Z on WIN SOURCE](#)
-  [OSRAM Opto Semiconductors Inc. Information](#)

## Optimize Your Supply Chain with WIN SOURCE Solutions

-  Global Sourcing Solution
-  Obsolete Management
-  Cost Control Management
-  Shortage Management
-  Alternative Solution
-  Excess Inventory Management