



THE DATASHEET OF SFH 4246-Z



IR-Lumineszenzdiode (940 nm) mit hoher Ausgangsleistung
High Power Infrared Emitter (940 nm)
Lead (Pb) Free Product - RoHS Compliant

SFH 4246



Wesentliche Merkmale

- Infrarot LED mit hoher Ausgangsleistung
- Kurze Schaltzeiten

Anwendungen

- IR-Datenübertragung
- Analoge und digitale Hi-Fi Audio- und Videosignalübertragung
- Anwendungen mit hohen Zuverlässigkeitsansprüchen bzw. erhöhten Anforderungen
- Alarm- und Sicherungssysteme

Sicherheitshinweise

Je nach Betriebsart emittieren diese Bauteile hochkonzentrierte, nicht sichtbare Infrarot-Strahlung, die gefährlich für das menschliche Auge sein kann. Produkte, die diese Bauteile enthalten, müssen gemäß den Sicherheitsrichtlinien der IEC-Normen 60825-1 und 62471 behandelt werden.

Features

- High Power Infrared LED
- Short switching times

Applications

- IR Data Transmission
- Analog and digital Hi-Fi audio and video signal transmission
- Suitable for professional and high-reliability applications
- Alarm and safety equipment

Safety Advices

Depending on the mode of operation, these devices emit highly concentrated non visible infrared light which can be hazardous to the human eye. Products which incorporate these devices have to follow the safety precautions given in IEC 60825-1 and IEC 62471.

Typ Type	Bestellnummer Ordering Code	Strahlstärkegruppierung ¹⁾ ($I_F = 70 \text{ mA}$, $t_p = 20 \text{ ms}$) Radiant Intensity Grouping ¹⁾ $I_e \text{ (mW/sr)}$
SFH 4246	Q65110A8100	$\geq 10 \text{ (typ. 30)}$

¹⁾ gemessen bei einem Raumwinkel $\Omega = 0.01$ / measured at a solid angle of $\Omega = 0.01 \text{ sr}$

Grenzwerte ($T_A = 25\text{ °C}$)**Maximum Ratings**

Bezeichnung Parameter	Symbol Symbol	Wert Value	Einheit Unit
Betriebs- und Lagertemperatur Operating and storage temperature range	T_{op}, T_{stg}	- 40 ... + 100	°C
Sperrspannung Reverse voltage	V_R	5	V
Vorwärtsgleichstrom Forward current	I_F	70	mA
Stoßstrom, $t_p = 100\ \mu\text{s}$, $D = 0$ Surge current	I_{FSM}	700	mA
Verlustleistung Power dissipation	P_{tot}	140	mW
Wärmewiderstand Sperrschicht - Umgebung bei Montage auf FR4 Platine, Padgröße je $16\ \text{mm}^2$ Thermal resistance junction - ambient mounted on PC-board (FR4), padsize $16\ \text{mm}^2$ each	R_{thJA}	500	K/W
Wärmewiderstand Sperrschicht - Lötstelle bei Montage auf Metall-Block Thermal resistance junction - soldering point, mounted on metal block	R_{thJS}	280	K/W

Kennwerte ($T_A = 25\text{ °C}$)**Characteristics**

Bezeichnung Parameter	Symbol Symbol	Wert Value	Einheit Unit
Wellenlänge der Strahlung Wavelength at peak emission $I_F = 70\ \text{mA}$	λ_{peak}	950	nm
Centroid-Wellenlänge der Strahlung Centroid wavelength $I_F = 70\ \text{mA}$	$\lambda_{centroid}$	940	nm
Spektrale Bandbreite bei 50% von I_{max} Spectral bandwidth at 50% of I_{max} $I_F = 70\ \text{mA}$	$\Delta\lambda$	42	nm
Abstrahlwinkel Half angle	φ	± 30	Grad deg.
Aktive Chipfläche Active chip area	A	0.04	mm^2

Kennwerte ($T_A = 25\text{ °C}$)**Characteristics** (cont'd)

Bezeichnung Parameter	Symbol Symbol	Wert Value	Einheit Unit
Abmessungen der aktiven Chipfläche Dimension of the active chip area	$L \times B$ $L \times W$	0.2×0.2	mm ²
Schaltzeiten, I_e von 10% auf 90% und von 90% auf 10%, bei $I_F = 70\text{ mA}$, $R_L = 50\ \Omega$ Switching times, I_e from 10% to 90% and from 90% to 10%, $I_F = 70\text{ mA}$, $R_L = 50\ \Omega$	t_r , t_f	11	ns
Durchlassspannung Forward voltage $I_F = 70\text{ mA}$, $t_p = 20\text{ ms}$ $I_F = 500\text{ mA}$, $t_p = 100\ \mu\text{s}$	V_F V_F	1.6 (< 2.0) 2.4 (< 3.0)	V V
Sperrstrom Reverse current	I_R	not designed for reverse operation	μA
Gesamtstrahlungsfluss Total radiant flux $I_F = 70\text{ mA}$, $t_p = 20\text{ ms}$	$\Phi_{e\text{ typ}}$	35	mW
Temperaturkoeffizient von I_e bzw. Φ_e , $I_F = 70\text{ mA}$ Temperature coefficient of I_e or Φ_e , $I_F = 70\text{ mA}$	TC_I	- 0.5	%/K
Temperaturkoeffizient von V_F , $I_F = 70\text{ mA}$ Temperature coefficient of V_F , $I_F = 70\text{ mA}$	TC_V	- 3.5	mV/K
Temperaturkoeffizient von λ , $I_F = 70\text{ mA}$ Temperature coefficient of λ , $I_F = 70\text{ mA}$	TC_λ	+ 0.3	nm/K

Strahlstärke I_e in Achsrichtung¹⁾gemessen bei einem Raumwinkel $\Omega = 0.01$ sr**Radiant Intensity I_e in Axial Direction**at a solid angle of $\Omega = 0.01$ sr

Bezeichnung Parameter	Symbol	Werte Values			Einheit Unit
		SFH 4246-R	SFH 4246-S	SFH 4246-T	
Strahlstärke Radiant intensity $I_F = 70$ mA, $t_p = 20$ ms	$I_{e \text{ min}}$ $I_{e \text{ max}}$	10 20	16 32	25 50	mW/sr mW/sr
Strahlstärke Radiant intensity $I_F = 500$ mA, $t_p = 25$ μ s	$I_{e \text{ typ}}$	75	120	185	mW/sr

¹⁾ Nur eine Gruppe in einer Verpackungseinheit (Streuung kleiner 2:1) /
Only one bin in one packing unit (variation lower 2:1)

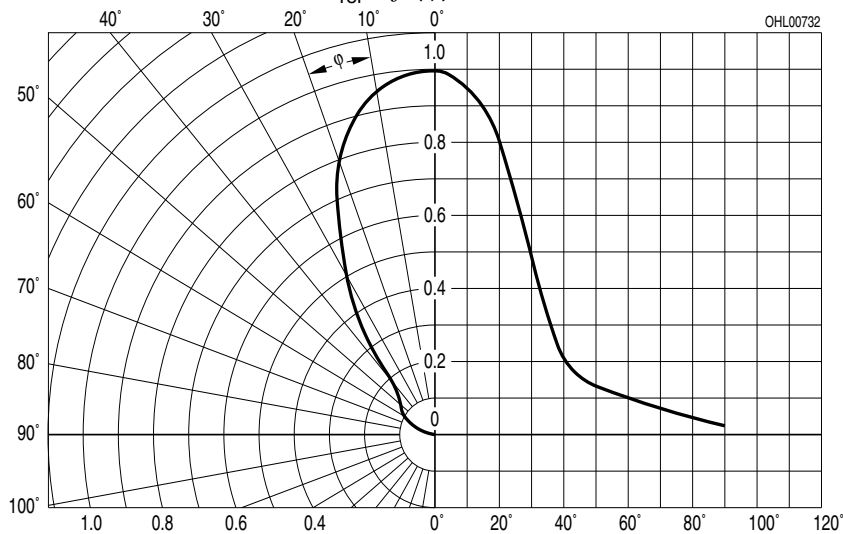
Abstrahlcharakteristik**Radiation Characteristics $I_{\text{rel}} = f(\varphi)$** 

Relative Spectral Emission

$I_{rel} = f(\lambda)$

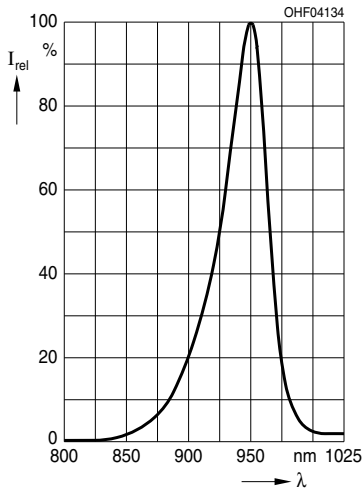

Radiant Intensity $\frac{I_e}{I_e 70 \text{ mA}} = f(I_F)$

Single pulse, $t_p = 25 \mu\text{s}$

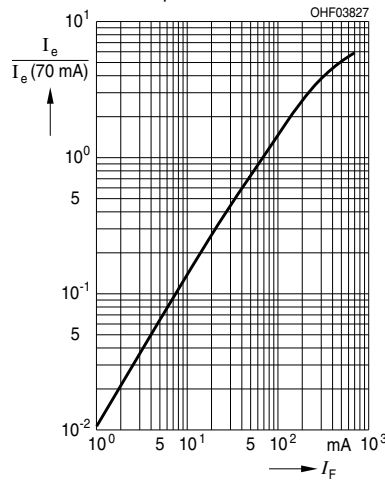

Max. Permissible Forward Current

$I_F = f(T_A), R_{thJA} = 500 \text{ K/W}$

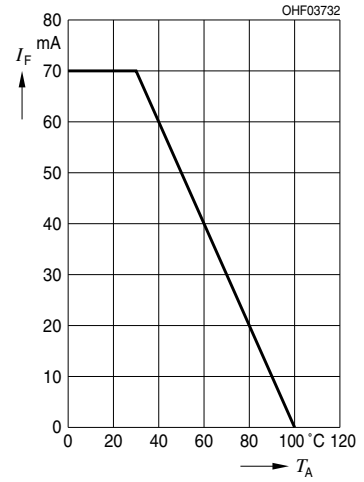

Forward Current $I_F = f(V_F)$

Single pulse, $t_p = 100 \mu\text{s}$

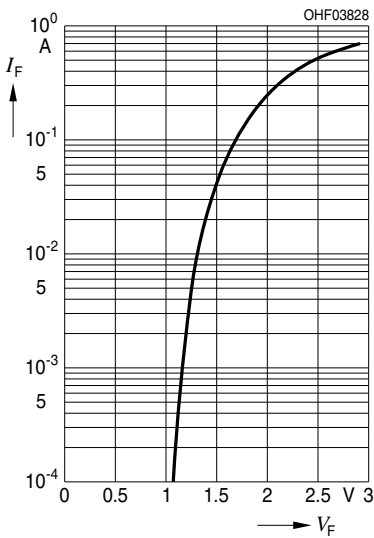

Permissible Pulse Handling Capability

$I_F = f(\tau), T_A = 25 \text{ }^\circ\text{C}$,
duty cycle $D =$ parameter

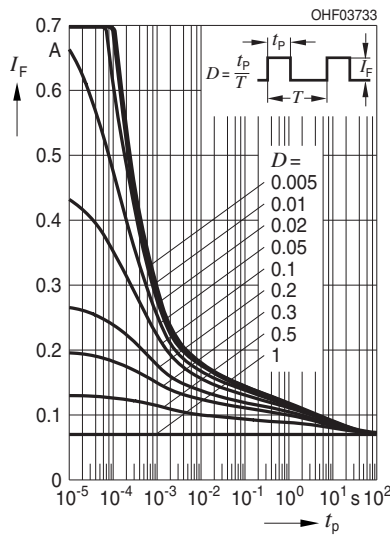

Permissible Pulse Handling Capability

$I_F = f(\tau), T_A = 85 \text{ }^\circ\text{C}$,
duty cycle $D =$ parameter

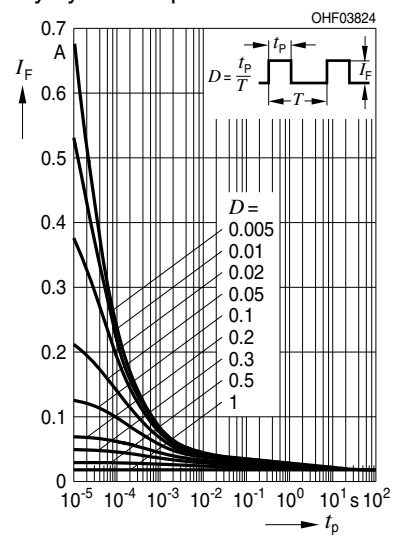

Maßzeichnung Package Outlines

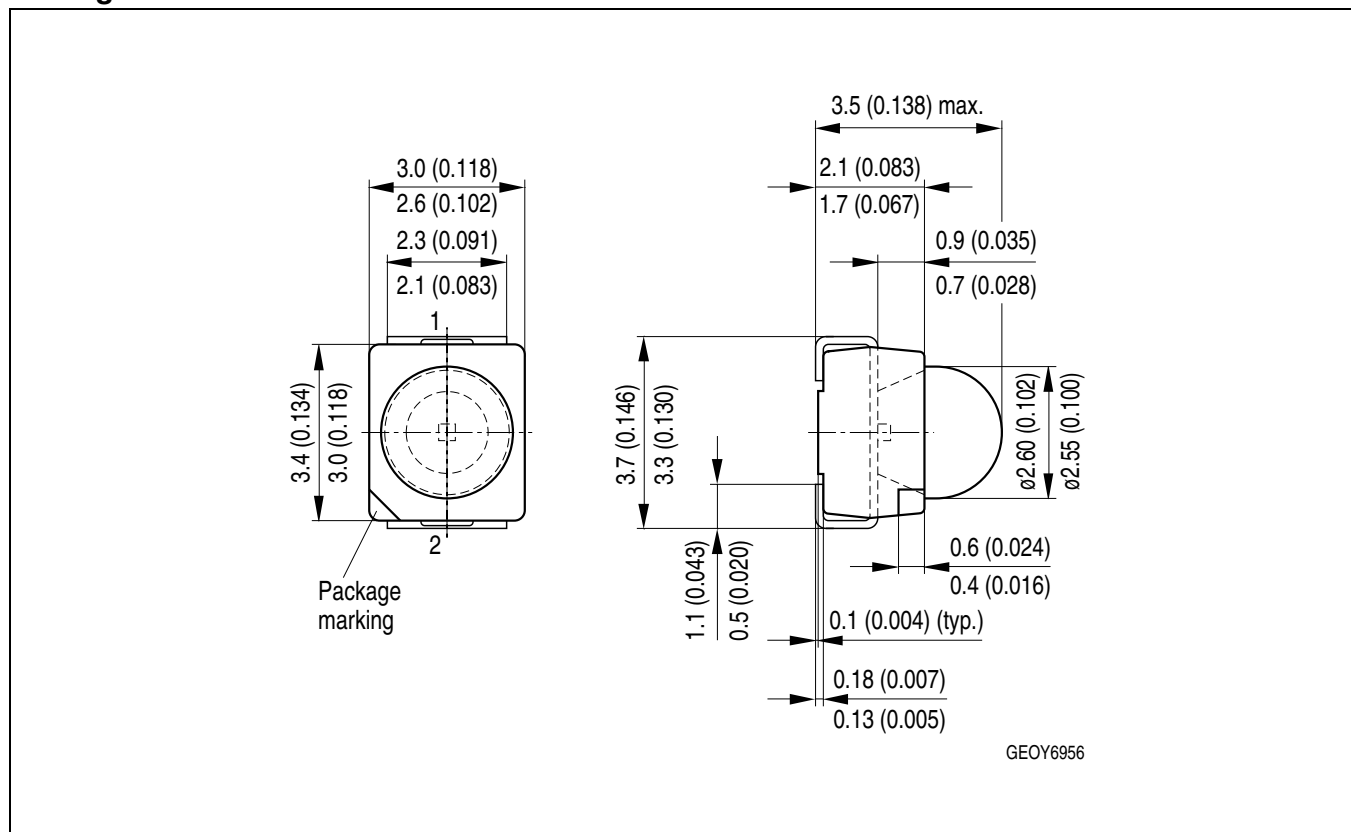

Maße in mm (inch) / Dimensions in mm (inch).

Gehäuse / Package	TOPLED® mit Linse (P-LCC-2) / TOPLED® with lens (P-LCC-2)
Anschlussbelegung pin configuration	1 = Anode / anode 2 = Kathode / cathode
Farbe Color	weiß white

Empfohlenes Lötpad design
Recommended Solder Pad

Reflow Lötén
Reflow Soldering

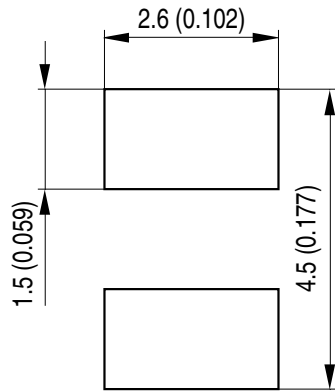

Padgeometrie für
 verbesserte Wärmeableitung
 Paddesign for
 improved heat dissipation

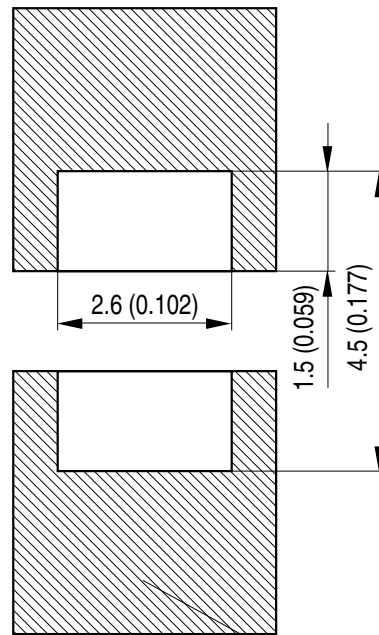

 Lötstopplack
 Solder resist

Cu-Fläche > 16 mm²
 Cu-area > 16 mm²

OHLPY970

Lötbedingungen
Soldering Conditions
Reflow Lötprofil für bleifreies Löten
Reflow Soldering Profile for lead free soldering

Vorbehandlung nach JEDEC Level 2
 Preconditioning acc. to JEDEC Level 2
 (nach J-STD-020D.01)
 (acc. to J-STD-020D.01)

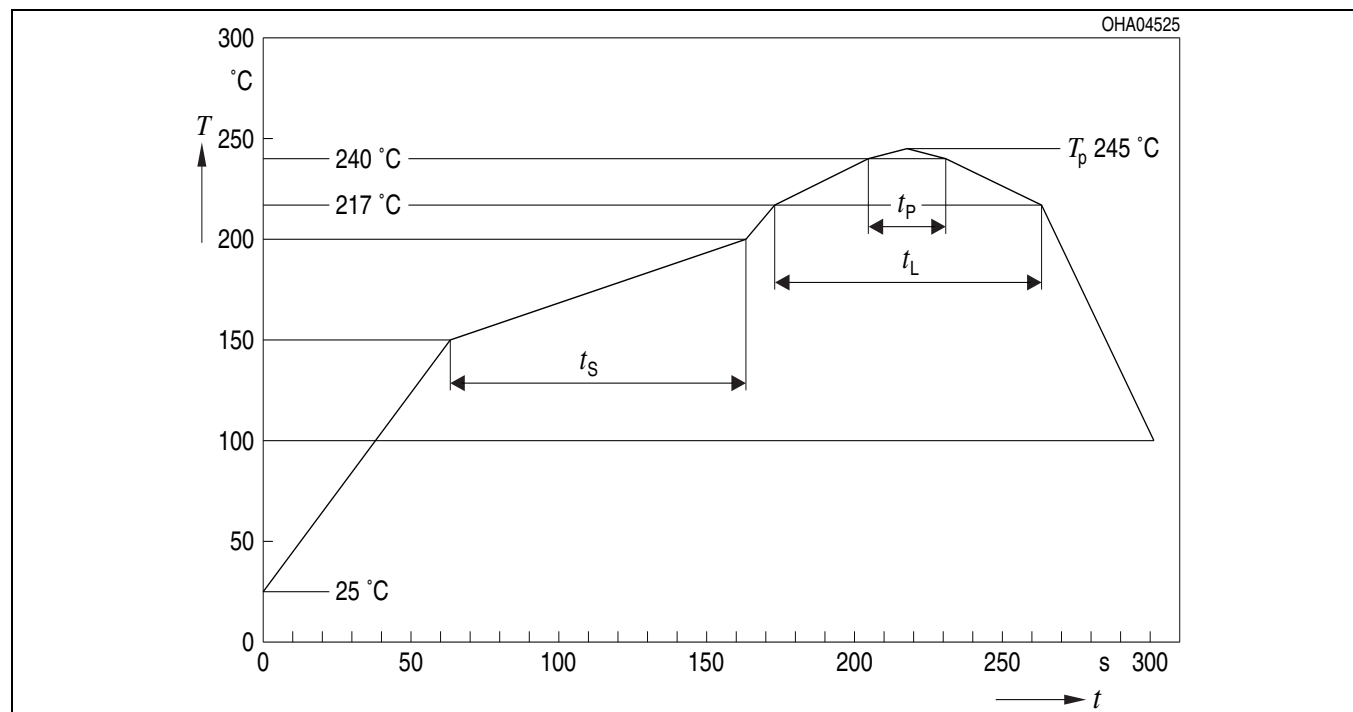

Profileigenschaften Profile Feature	Bleifreier Aufbau / Pb-Free Assembly (SnAgCu)	
	Empfehlung / Recommendation	Grenzwerte / Max. Ratings
Aufheizrate zum Vorwärmen ^{*)} / Ramp-up rate to preheat ^{*)} 25 °C to 150 °C	2 K / s	3 K / s
Zeit t_s von T_{Smin} bis T_{Smax} / Time t_s from T_{Smin} to T_{Smax} 150 °C to 200 °C	100 s	min. 60 s max. 120 s
Aufheizrate zur Spitztemperatur ^{*)} / Ramp-up rate to peak ^{*)} 180 °C to T_p	2 K / s	3 K / s
Liquidustemperatur T_L / Liquidus temperature T_L	217 °C	
Zeit t_L über T_L / Time t_L above T_L	80 s	max. 100 s
Spitztemperatur T_p / Peak temperature T_p	245 °C	max. 250 °C
Verweilzeit t_p innerhalb des spezifizierten Spitztemperaturbereichs $T_p - 5$ K / Time t_p within the specified peak temperature range $T_p - 5$ K	20 s	min. 10 s max. 30 s
Abkühlrate ^{*)} / Ramp-down rate ^{*)} T_p to 100 °C	3 K / s	4 K / s maximum
Zeitspanne von 25 °C bis zur Spitztemperatur / Time from 25 °C to peak temperature		max. 8 min.

Alle Temperaturen beziehen sich auf die Bauteilmitte, jeweils auf der Bauteiloberseite gemessen / All temperatures refer to the center of the package, measured on the top of the package

* Steigungsberechnung $\Delta T/\Delta t$: Δt max. 5 s; erfüllt über den gesamten Temperaturbereich / slope calculation $\Delta T/\Delta t$: Δt max. 5 s; fulfillment for the whole T-range

Wellenlötten (TTW) TTW Soldering

(nach CECC 00802)
(acc. to CECC 00802)

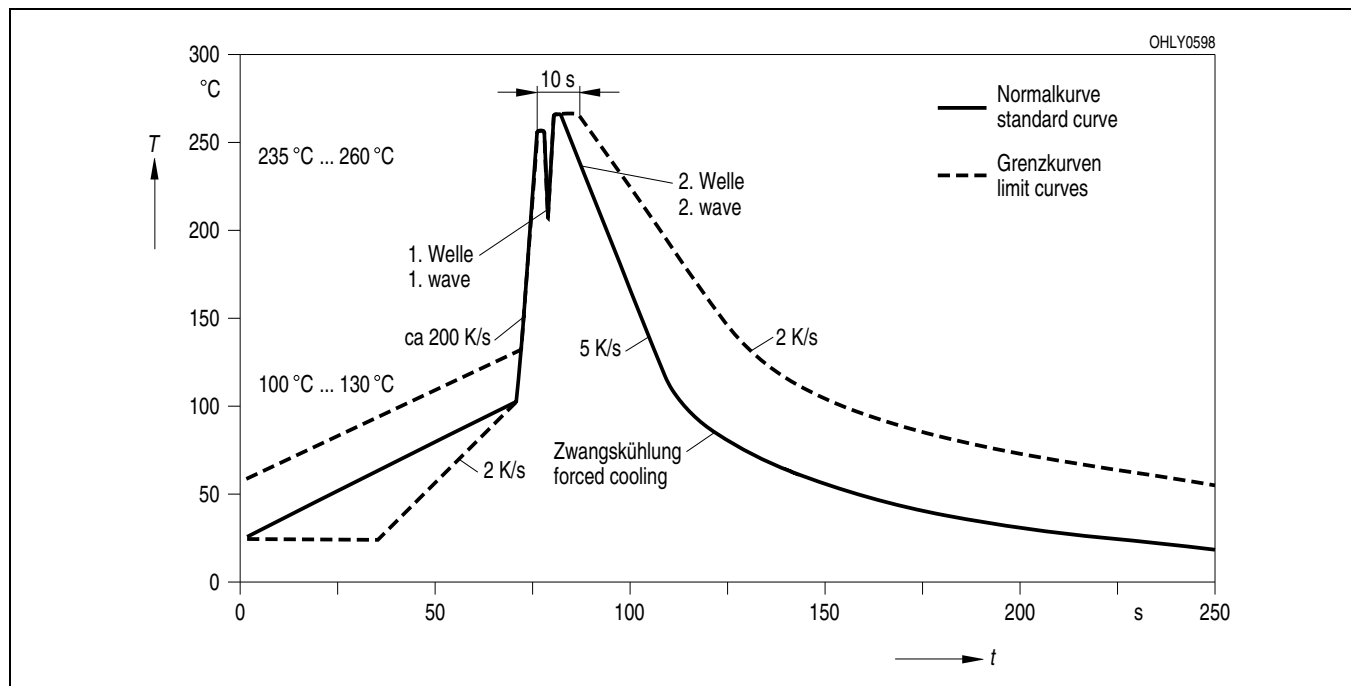

Published by
OSRAM Opto Semiconductors GmbH
Leibnizstrasse 4, D-93055 Regensburg
www.osram-os.com

© All Rights Reserved.

The information describes the type of component and shall not be considered as assured characteristics. Terms of delivery and rights to change design reserved. Due to technical requirements components may contain dangerous substances. For information on the types in question please contact our Sales Organization.

Packing

Please use the recycling operators known to you. We can also help you – get in touch with your nearest sales office. By agreement we will take packing material back, if it is sorted. You must bear the costs of transport. For packing material that is returned to us unsorted or which we are not obliged to accept, we shall have to invoice you for any costs incurred.

Components used in life-support devices or systems must be expressly authorized for such purpose! Critical components¹, may only be used in life-support devices or systems² with the express written approval of OSRAM OS.

¹ A critical component is a component used in a life-support device or system whose failure can reasonably be expected to cause the failure of that life-support device or system, or to affect its safety or effectiveness of that device or system.

² Life support devices or systems are intended (a) to be implanted in the human body, or (b) to support and/or maintain and sustain human life. If they fail, it is reasonable to assume that the health of the user may be endangered.

EU RoHS and China RoHS compliant product





此产品符合欧盟 RoHS 指令的要求；

按照中国的相关法规和标准，不含有毒有害物质或元素。

Looking for pricing, stock, or lifecycle information?

Click below to explore more details on WIN SOURCE:

-  [View SFH 4246-Z on WIN SOURCE](#)
-  [OSRAM Opto Semiconductors Inc. Information](#)

Optimize Your Supply Chain with WIN SOURCE Solutions

-  Global Sourcing Solution
-  Obsolete Management
-  Cost Control Management
-  Shortage Management
-  Alternative Solution
-  Excess Inventory Management