



**THE DATASHEET OF
SM0603UV-395**



SURFACE MOUNT LED ULTRAVIOLET, 0603 PACKAGE

BIVAR

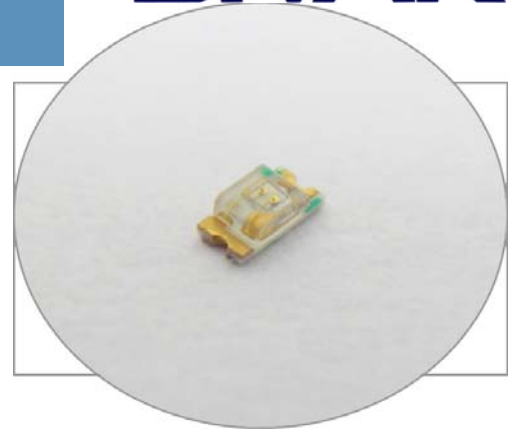

SM0603UV-395

- ◆ Industry Standard 0603 Package
- ◆ RoHS Compliant
- ◆ UV Emitting LED
- ◆ Water Clear Lens
- ◆ Wide Viewing Angle
- ◆ Ideal for Curing, Detection, and Medical Applications

Bivar's Surface Mount 0603 UV package LED is offered in a standard 0603 foot print and is ideal for any UV applications. The miniature package provides long life and reliability making it ideal for industrial curing, hazard detection, medical applications such as instrument sterilization, fluorescent counterfeit watermark detection, and forensic applications. The water clear LED lens provides for maximum radiant power output and wide viewing angles. Bivar SM0603 UV LED is packaged in standard tape and reels for pick and place assemblies.

Part Number	Material	Emitted Color	Peak Wavelength λ_p (nm)	Lens Appearance	Radiant Power (mW)	Viewing Angle
SM0603UV-395	InGaN/SiC	ULTRAVIOLET	395 ~ 400	Water Clear	5 ~ 10	130°

Outline Dimensions

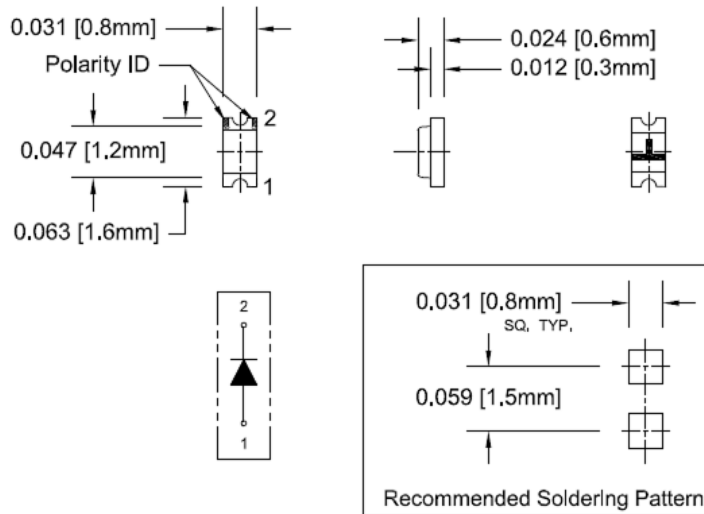

Outline Drawings Notes:

1. All dimensions are in inches [millimeters].
2. Standard tolerance: ± 0.010 " unless otherwise noted.



CAUTION: EMITS ULTRAVIOLET RADIATION!!

- This UV (ultraviolet) LED during operation radiates intense UV light.
 - Do not look directly into the UV light during operation of device. This can be harmful to human body especially to the eyes and skin, even for brief period due to the intense UV light.
 - If viewing the UV light is necessary, please use UV filtered glasses to avoid damage by the UV light.
 - If the UV LED in your product might be viewed directly, please affix a caution label to your product to that effect.
- Avoid direct eye and skin exposure to UV light. Keep out of reach of children.



Bivar reserves the right to make changes at any time without notice.

SURFACE MOUNT LED ULTRAVIOLET, 0603 PACKAGE



Absolute Maximum Ratings

$T_A = 25^\circ\text{C}$ unless otherwise noted

Power Dissipation	100 mW
Forward Current (DC)	25 mA
Peak Forward Current ¹	100 mA
Reverse Voltage	5 V
Operating Temperature Range	-30 ~ +80°C
Storage Temperature Range	-40 ~ +85°C
Lead Soldering Temperature (3 mm from the base of the epoxy bulb) ²	260°C

Notes: 1. 10% Duty Cycle, Pulse Width \leq 0.1 msec. 2. Solder time less than 5 seconds at temperature extreme.

Electrical / Optical Characteristics

$T_A = 25^\circ\text{C}$ & $I_F = 20\text{ mA}$ unless otherwise noted

Part Number	Forward Voltage (V) ¹			Recommend Forward Current (mA)			Reverse Current (μA)	Dominant Wavelength (nm) ²			Radiant Power (mW)			Viewing Angle $2\theta_{1/2}$ (deg)
	MIN	TYP	MAX	MIN	TYP	MAX	MAX	MIN	TYP	MAX	MIN	TYP	MAX	TYP
SM0603UV-395	/	3.4	4.2	/	20	/	10	/	/	/	5	/	10	130

Notes: 1. Tolerance of forward voltage : $\pm 0.05\text{V}$. 2. Tolerance of dominant wavelength : $\pm 1.0\text{nm}$.

Bivar reserves the right to make changes at any time without notice.

SURFACE MOUNT LED ULTRAVIOLET, 0603 PACKAGE



Typical Electrical / Optical Characteristics

$T_A = 25^\circ\text{C}$ unless otherwise noted

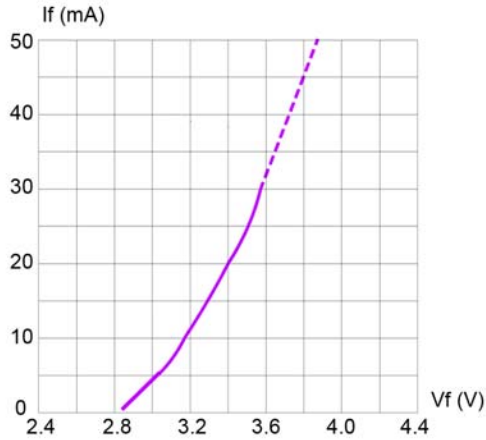

Fig. 1 Forward Current vs. Forward Voltage

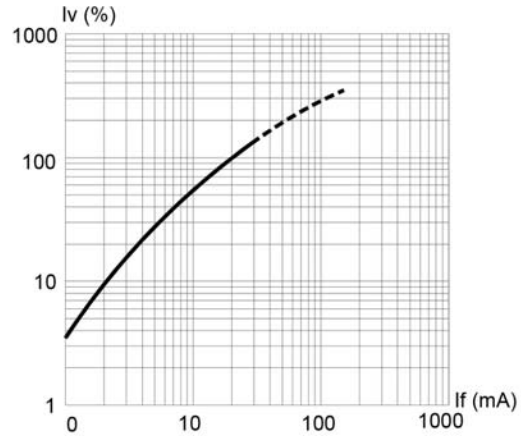

Fig. 2 Relative Luminous Intensity vs. Forward Current

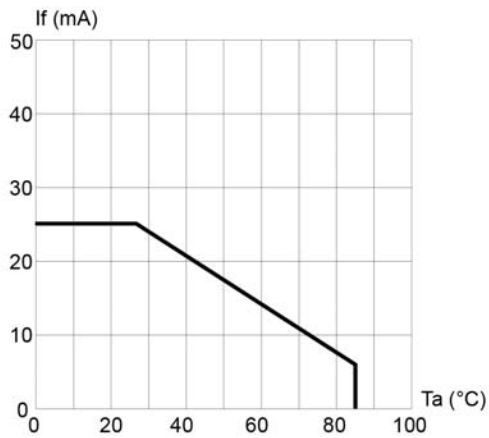

Fig. 3 Forward Current vs. Temperature

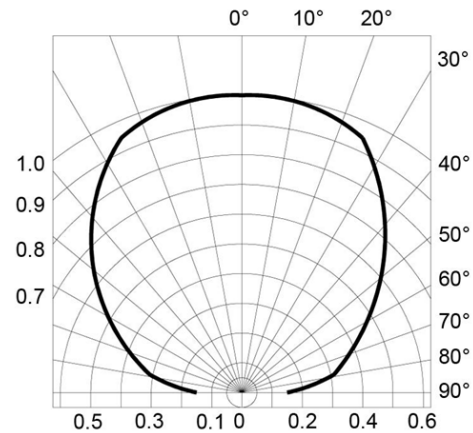

Fig. 4 Directivity Radiation Diagram

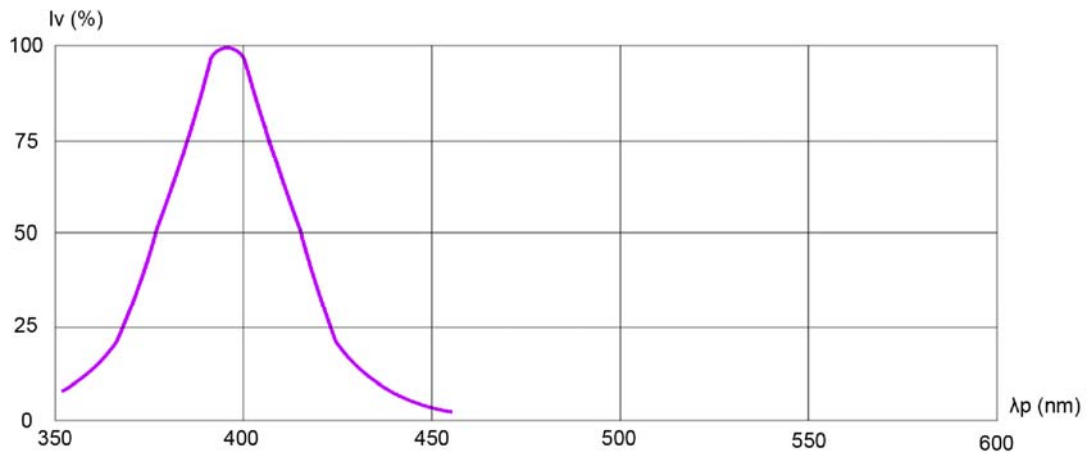

Fig. 5 Relative Luminous Intensity vs. Peak Wavelength

Bivar reserves the right to make changes at any time without notice.

SURFACE MOUNT LED ULTRAVIOLET, 0603 PACKAGE



Recommended Soldering Conditions

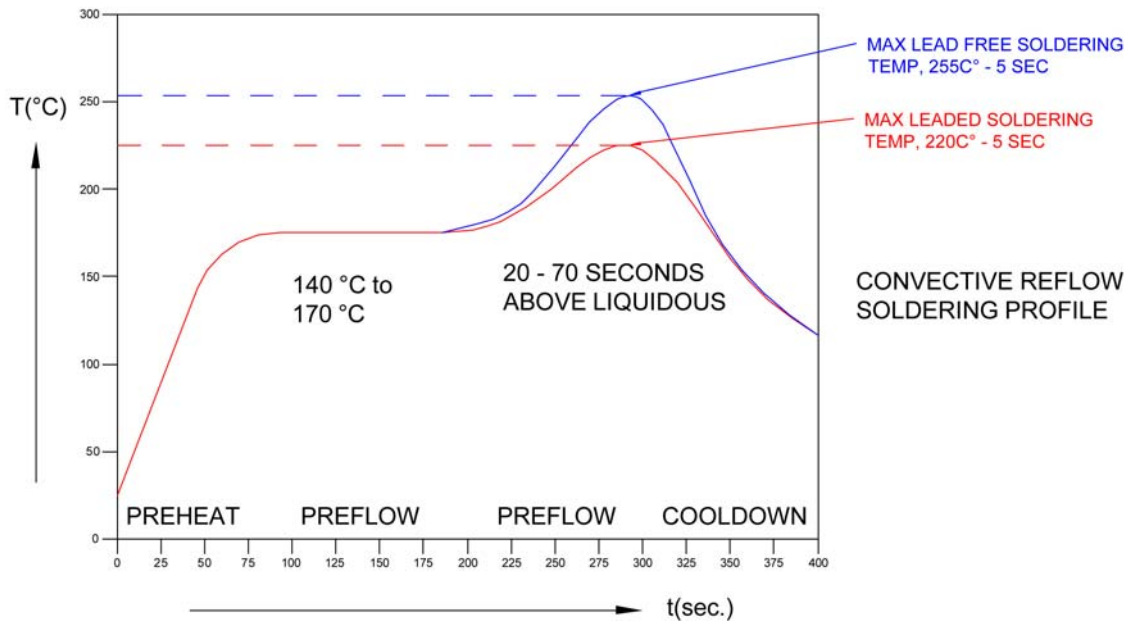

Tape and Reel Dimensions

Note: 4000 pcs/Reel

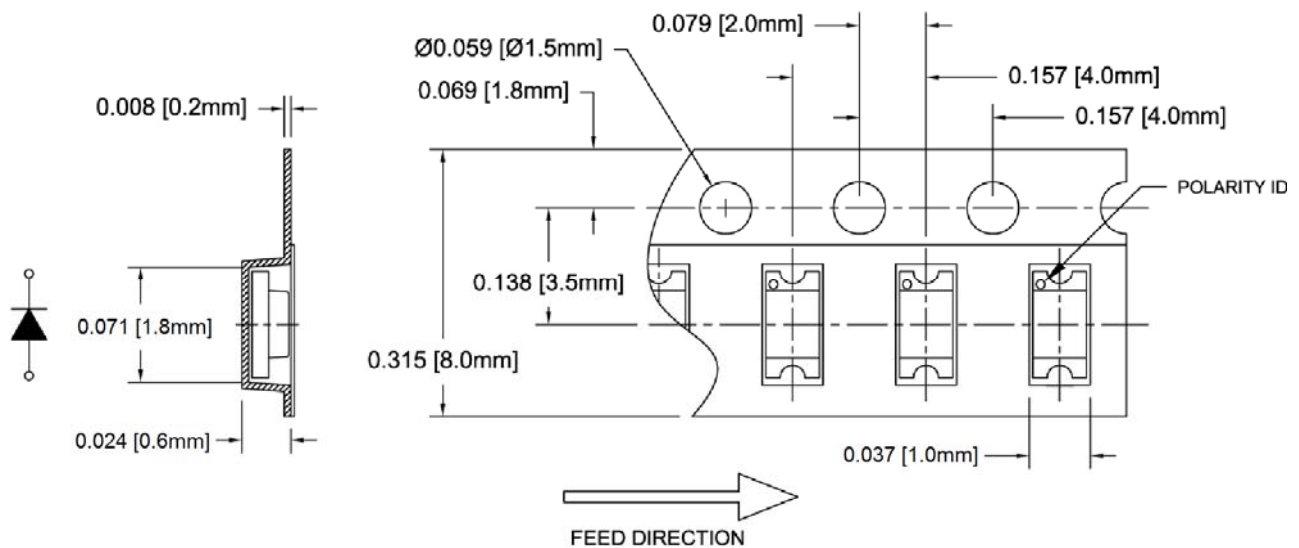

Outline Drawings Notes:

1. All dimensions are in inches [millimeters].
2. Standard tolerance: $\pm 0.010''$ unless otherwise noted.

Bivar reserves the right to make changes at any time without notice.

SURFACE MOUNT LED ULTRAVIOLET, 0603 PACKAGE



Outline Drawings Notes:

1. All dimensions are in inches [millimeters].
2. Standard tolerance unless otherwise noted: X.XXX ± 0.010"
X.X ± 0.1"

Packaging and Labeling Plan

Note: 1 Reel / Bag

Vacuum and Heat Sealed
ESD/MBB Bag

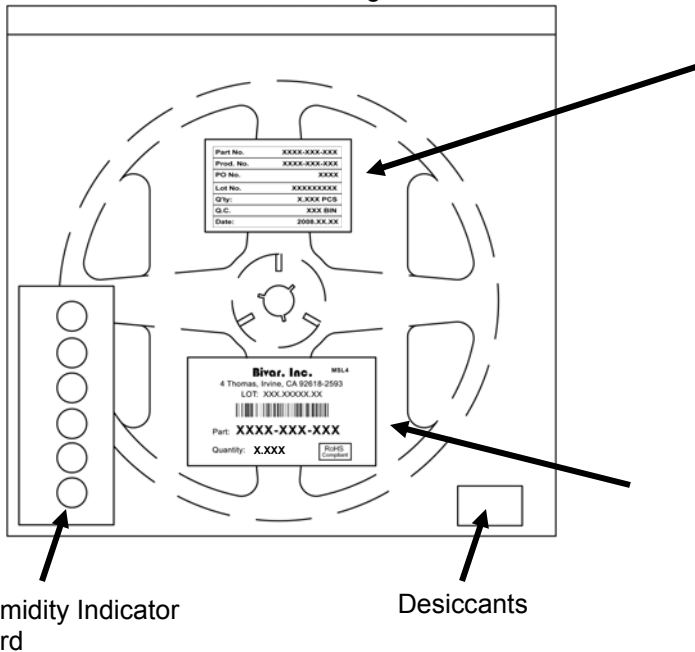

Part No.	XXXX-XXX-XXX
Prod. No.	XXXX-XXX-XXX
PO No.	XXXX
Lot No.	XXXXXXXXXX
Q'ty:	X.XXX PCS
Q.C.	XXX BIN
Date:	2008.XX.XX

Internal Quality Control

Bivar, Inc. MSL4

4 Thomas, Irvine, CA 92618-2593
LOT: XXX.XXXXX.XX



Part: **XXXX-XXX-XXX**

Quantity: **X.XXX**

RoHS
Compliant

Bivar Standard Packaging Label

Bivar reserves the right to make changes at any time without notice.

Looking for pricing, stock, or lifecycle information?

Click below to explore more details on WIN SOURCE:

 [View SM0603UV-395 on WIN SOURCE](#)

 [Bivar Inc. Information](#)

Optimize Your Supply Chain with WIN SOURCE Solutions

-  Global Sourcing Solution
-  Obsolete Management
-  Cost Control Management
-  Shortage Management
-  Alternative Solution
-  Excess Inventory Management